

NOVEMBER • 1955

PRICE 75 CENTS

electronics

A MCGRAW-HILL PUBLICATION



SLURRYING
PHOSPHOR
ON COLOR
TUBE

Sonics and
Electroacoustics
page 399

Ceramic Receiving Tube
page 176

Cards Control Job-Lot Assembly
page 122



for the HIGHEST in RELIABILITY

UTC products are the most copied in the world. This is only natural, since we maintain the largest laboratories and engineering staff in our field. However, copying alone cannot provide the measure of uniformity and reliability inherent in UTC units. To provide for the maximum in quality and reliability, continuing programs of quality control and quality improvement are constantly maintained in our laboratories.

WHAT MAKES A TRANSFORMER FAIL?
Illustrated are a few views of the UTC Reliability Laboratory in action... finding the answers.



Qualitative micro analysis.

Vibration stress analysis.

Torque testing of standard assemblies.



Checking uniformity of thermoplastic compounds.

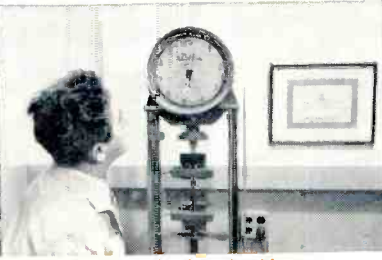

Quantitative checking of weld strength.

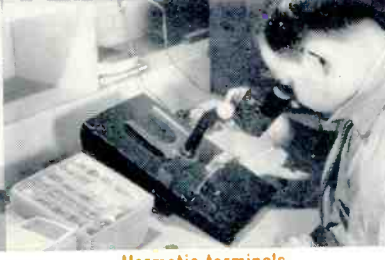

Hermetic terminals on microscope check.



Chemical section analyzing new materials.



Microscope analysis of dissected units.



Calibration to primary standards.



Pilot plant hydrogen annealing.



Seal tests under extremes of cold, heat, and altitude.



Abrasion and mercury tests on magnet wire.



Pilot plant run on encapsulating material.



Corrosion testing on insulating materials.



Non-destructive quality control by x-ray.

IS THIS PROVEN RELIABILITY AND UNIFORMITY IN THE COMPONENTS OF YOUR EQUIPMENT?

A large aircraft company... "Our vendor analysis for past year (thousands of tests) shows zero rejects."

A large electric company... "Consistent quality has placed you as our #1 source... are grateful for the aid you have given our own quality control staff."

A large military electronics company... "Switching from former vendor to UTC has saved us 18% of transformer and filter cost by reducing manufacturing costs."

A large instrumentation company... "We haven't had one field failure in fifteen years' use of UTC parts*."

*Over 100,000 units.

United Transformer Co.
150 VARICK STREET • NEW YORK 13, N. Y.
EXPORT DIVISION: 13 EAST 40th STREET, NEW YORK 16, N. Y. CABLES: "AR"

H. W. MATEER, *Publisher*

W. W. MacDONALD, *Editor*

VIN ZELUFF, *Managing Editor*

JOHN MARKUS, *Associate Editor*

ALEXANDER A. MCKENZIE, *Associate Editor*

JOHN M. CARROLL, *Associate Editor*

WILLIAM P. O'BRIEN, *Assistant Editor*

WILLIAM G. ARNOLD, *Assistant Editor*

DAVID A. FINDLAY, *Assistant Editor*

HAIG A. MANOOGIAN, *Assistant Editor*

EDMUND B. PALMQUIST, *Assistant Editor*

GLORIA J. FILIPPONE, *Editorial Assistant*

ARLENE SCHILP, *Editorial Assistant*

FRANCES SULLIVAN, *Editorial Assistant*

GLADYS T. MONTGOMERY, *Washington Editor*

HARRY PHILLIPS, *Art Director*

WALLACE B. BLOOD, *Manager*

R. S. QUINT, *Buyers' Guide Manager*

FRANK H. WARD, *Business Manager*

GEORGE E. POMEROY, *Classified Manager*

DONALD H. MILLER, *New York*

JAMES GIRDWOOD, *New York*

WM. S. HODGKINSON, *New England*

JAMES T. HAUPTLI, *Philadelphia*

CHARLES WARDNER, *Chicago*

BRUCE WINNER, *Chicago*

HENRY M. SHAW, *Cleveland*

T. H. CARMODY, *San Francisco*

R. C. ALCORN, *San Francisco*

CARL W. DYSINGER, *Los Angeles*

WM. D. LANIER, *Atlanta*

JAMES H. CASH, *Dallas*

KEITH HENNEY, *Consultant*

SLURRYING PHOSPHOR ON COLOR TUBE—Production method used for RCA color kinescopes employs centrifuge to spread phosphor, supplanting the slower method of suspension deposition (see page 180)..... COVER

SHOPTALK 2

FIGURES OF THE MONTH 6

INDUSTRY REPORT 7

Long-Distance VHF Circuit.....	7	New Materials Evolve New Tubes....	16
Europeans To Study Color-TV.....	7	Industry Continues To Grow.....	16
Color-Tube Design Progresses.....	8	Sun Powers Telephone Line.....	20
Industry Holds Share Of Buying.....	8	Defense Is Big In Canada.....	20
Digital Computers Seek New Fields..	10	Electronics In Massachusetts.....	20
FCC Asks For VHF Channels.....	10	Color Bulbs Go Conventional.....	22
Research Buys Testing Gear.....	12	Headlight Dimmers Make Gains.....	22
Bundling Cuts Cost.....	12	Transmitter Runs On Decibels.....	24
Transistor's Future Looks Bright....	14	Flat-Top Sounds Off With Tubes....	24
Machine Makers Go Electronic.....	14	Defense Wants Reliability.....	24
Radio Replaces Cable.....	14	Financial Roundup	26
Build-It-Yourself Computer	14	Future Meetings	26
		Industry Shorts	26

CROSSTALK 121

FEATURES

Punched Cards Control Job-Lot Assembly System 122

By G. W. Gamble, C. J. Godwin and F. S. Feldheim

Temperature Indicator for Aircraft Engines 129

By Harold Koletsky

Transistor Pulse Generators 132

By W. S. Eckess, J. E. Deavenport and K. I. Sherman

Helicopter Measures Antenna Patterns 134

By Helmut Brueckmann

Spectrometer Regulator Stabilizes R-F 137

By Walter Donner

Matrixing and Encoding Color for Telecasting 140

By H. Taub, J. Rabinowitz, D. Schacher and M. Star

Pulsed Eddy Currents Gage Plating Thickness 146

By Donald L. Waidelich

Repetition-Rate Generator Has High Accuracy 148

By Fred A. Plemenos

UHF Multiplexer Uses Selective Couplers 152

By Herbert J. Carlin

CONTINUED ON NEXT PAGE

contents

continued

Cathode Compensation Linearizes Video Stage.....	156
By Jacob Millman and Herbert Taub	
Series Tube Modulates Amplifier Screen-Grid.....	158
By W. B. Bernard	
Direct-Reading Noise-Figure Indicator.....	161
By C. E. Chase	
Low-Ripple Adjustable Regulated Power Supply.....	164
By George Hetland, Jr. and Robert R. Buss	
Basic Chassis for Experimental Work.....	166
By N. M. Emslie	
Ultrasonic Switch Aids Diversity Reception.....	169
By G. Franklin Montgomery	
Square-Law Detector for RMS Voltages.....	170
By James W. Sauber	
Noise Factor Nomograph (Reference Sheet).....	174
By Stuart McCarrell	

ELECTRONS AT WORK..... 176

Machinery Parts Speeded by Radio.....	176	Flat Cathode-Ray Tubes.....	186
Tiny Tube Amplifies UHF-TV.....	176	British TV Tower.....	188
Solar Battery Powers Telephone.....	178	Electronic Chopper.....	192
AEW Planes Keep Continuous		Nonlinear Time-Delay Generator.....	194
Watch.....	178	Precise Measurement of Sawtooth.....	204
The Front Cover.....	180	Computer-Controlled Fin.....	212
Albion Tries Commercial TV.....	180	Electronic Load.....	216
Preferred Circuits Standardization.....	182	Precision Time-Delay.....	218

PRODUCTION TECHNIQUES..... 220

Three-Operator Assembly-Turntable.....	222	Controlling Sludge in Etching Bath.....	238
Magnetic Holder for Drill Gage.....	222	Tin Reflowing Aids Wire-Stripping.....	242
Midget Train Delivers TV Cabinets.....	224	Recorder Checks Linearity of Pots.....	244
Card-Controlled Assembly Machine.....	224	Automatic Belting of Resistors.....	248
Wire-Coiling Dish.....	226	Water-Dip Cleans Terminals.....	254
Tote Rack for I-F Strips.....	226	Filament-Inserting Funnel.....	256
Applying Varnish to Coil.....	228	Vacuum Metalizing of Selenium.....	258
Quick-Release Clamps for Dollies.....	230	Resistor Lead Cutter.....	260
Life Test Setup.....	234	Rotational Life-Tester.....	262
Linotype Slugs Identify Wires.....	236	Cutting Cards for Tapered Pots.....	266
Terminal Plug Holder.....	236		

NEW PRODUCTS..... 270

LITERATURE..... 349

PLANTS AND PEOPLE..... 364

NEW BOOKS..... 399

THUMBNAIL REVIEWS..... 404

BACKTALK..... 406

INDEX TO ADVERTISERS..... 455

SHOP

► **THANKS** . . . Another firm in our industry now puts out for its employees a periodic dope sheet containing digests of important articles appearing in current magazines.

We note with great interest that most of them (and the best, we hope) are from a certain magazine that modesty forbids our mentioning.

► **POESY** . . . We are indebted to George Tillman of Syracuse for the following:

'Twas the day ELECTRONICS
October is here;
Engineers are unhappy
There's brine in their beer.

On page 16 there's a low-flying blimp
Photo quite lovely, but caption quite limp;
The reason is painful, as we all can see
One of your boys had left out GE.

We apologize.

► **BUNDLING** . . . Not a revival of an early American custom, but a simple method of grouping components between wiring boards is described in Industry Report this month, page 12. It allows change of circuit without involving high tool cost.

As developed so far, certain operations are done manually but in the final design an automatic insertion head would take a component and cut, bend and insert the leads.

PSYCHOLOGY OF A WORD—Having watched the development of microwave plumbing from the rain pipe days to the high-precision fabrication of modern equipment, we nevertheless have had a

electronics

NOVEMBER, 1955 Vol. 28, No. 11



Member ABC and ABP

TALK

feeling of awe whenever we saw fancy new gear.

It took a slight mistranslation to rid us of that feeling forever.

Editorial material sent in by a Japanese engineer from overseas includes photographs of disassembled sections of waveguides. His caption reads "decomposed sections of waveguide."

► **UTILECTART . . .** While collecting material on automatic production techniques, we collected components of various shapes and sizes. As the pile grew, it caught the artistic eye of Everett Hoffman, who deals with graphic aspects of the advertising art. By arranging the various components esthetically on boards he came up with some interesting patterns that aroused our curiosity.

Hoffman calls the technique "utillectart," for utility, electronics and art. Before we could stop him he went on:

"The idea of spatial organization in a picture has been an artistic challenge to painters and designers alike throughout the history of art. The problem is simply one of combining visual elements within a picture plane for the purpose of treating the eye . . .

"The subjective or story-telling virtues of a picture are quite separate and distinct from the artistic or esthetic problems solved . . . Not that the subjective can be ignored, for though picture-making is a highly debatable art, we do not pre-

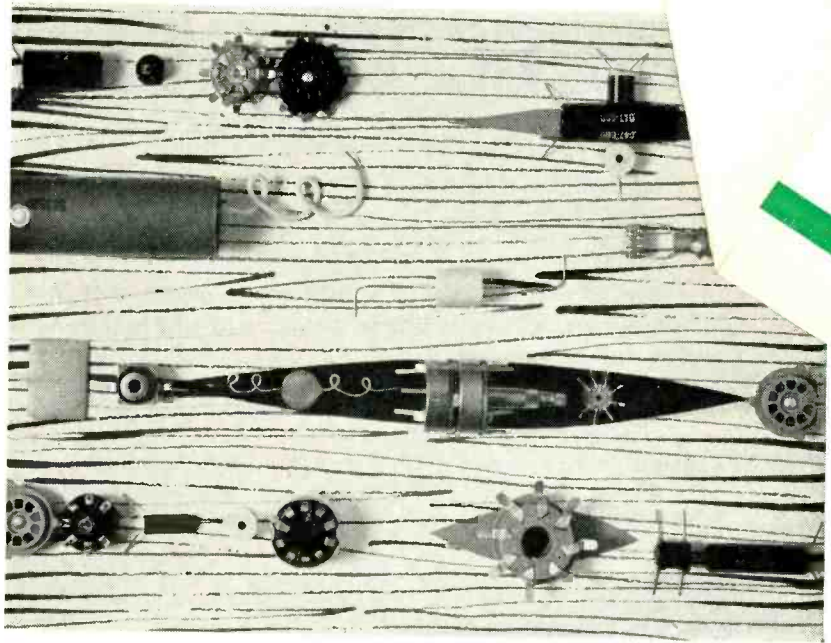

UTILITY, electronics and art are combined in these Hoffman abstractions based on newly designed components for automatic production

sume to be dogmatic . . .

"It was the European artists who made the first real break with tradition, the Fauves and the Cubists who provided the intellectual ammunition for these two-dimensional constructions. The early twentieth century French artists who developed a new way of looking at things are the artistic fathers of these pieces . . .

"What I wish to show is that some of the most beautiful of the objects of our Machine Age are conceived of as functional, useful objects respecting strict laws of physics."

We like the patterns, anyhow.

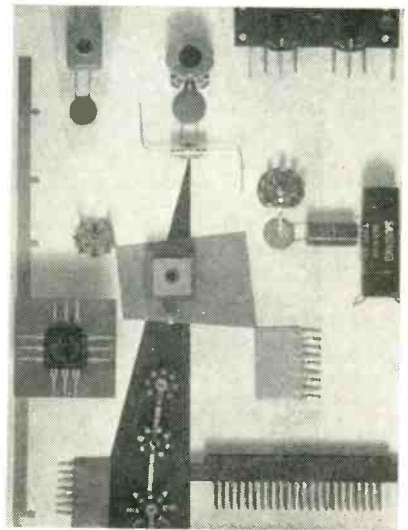

Published monthly with an additional issue in June by McGraw-Hill Publishing Company, Inc., James H. McGraw (1860-1948), Founder, Executive, Editorial and Advertising Offices; McGraw-Hill Building, 330 W. 42 St., New York 36, N. Y. Longacre 4-3000. Publication Office, 99-129 North Broadway, Albany 1, N. Y. Donald C. McGraw, President; Paul Montgomery, Executive Vice-President; Joseph A. Gerardi, Vice-President and Treasurer; John J. Cooke, Secretary; Nelson Bond, Executive Vice-President, Publications Division; Ralph B. Smith, Vice-President and Editorial Director; Joseph H. Allen, Vice-President and Director of Advertising; J. E. Blackburn, Jr., Vice-President and Circulation Director.

Subscriptions: Address correspondence to Electronics—Subscription Service, 330 W. 42nd St., New York 36, N. Y. Allow one month for change of address. Subscriptions are solicited only from persons engaged in theory, research, design, production, maintenance and use of electronic and industrial control components, parts and end products. Position and company connection must be indicated on subscription orders.

Single copies 75¢ for United States and possessions, and Canada; \$1.50 for Latin America; \$2.00 for all other foreign countries. Buyers' Guide \$3.00. Subscription rates—United States and possessions, \$6.00 a year; \$9.00 for two years. Canada, \$10.00 a year; \$16.00 for two years. Other western hemisphere countries and the Philippines, \$15.00 a year; \$25 for two years. All other countries \$20.00 a year; \$30.00 for two years. Three-year rates, accepted on renewals only, are double the one-year rate. Entered as second-class matter August 29, 1936, at the Post Office at Albany, N. Y., under act of Mar. 3, 1879. Printed in U.S.A. Copyright 1955 by McGraw-Hill Publishing Co., Inc.—All Rights Reserved.

BRANCH OFFICES: 520 North Michigan Avenue, Chicago 11, Ill.; 68 Post Street, San Francisco 4; McGraw-Hill House, London, E. C. 4; Washington, D. C. 4; Philadelphia 3; Cleveland 15; Detroit 26; St. Louis 8; Boston 16; 1321 Rhodes-Bavery Bldg.; Atlanta 3, Ga.; 1111 Wilshire Blvd., Los Angeles 17; 919 Oliver Building, Pittsburgh 23. ELECTRONICS is indexed regularly in The Engineering Index.

Build SORENSEN REGULATION into your products with these new

MAGNETIC VOLTAGE REGULATORS

CAPACITIES — 15VA, 30VA, 60VA, 120VA, 250VA, 500VA.

TUBELESS — *trouble free*

COMPACT — *saves space in your equipment*

LIGHTER *than comparable regulators*

GOOD APPEARANCE — *enhances your product*

THERMALLY ISOLATED CASE — *simplifies your design problems*

ELECTRICAL SPECIFICATIONS

Input voltage range 95-130VAC, 1 \emptyset , 60 cycles.

Output range 115VAC, RMS, 1 \emptyset .

Regulation accuracy $\pm 0.5\%$ against line changes.

Load conditions $\pm 0.5\%$ against line at any given load from 0 to full.

Time constant From 2 to 6 cycles for line changes.



MVR15



MVR60



MVR250

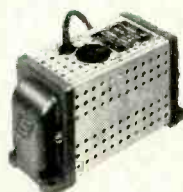

MVR30



MVR120



MVR500

GET MORE INFORMATION: Catalog MVR2 is yours for the asking; gives complete data on the new Magnetic Voltage Regulator line. Contact your local Sorensen representative, or write to General Sales Department, Sorensen & Co., Inc., 375 Fairfield Ave., Stamford, Conn.



CONTROLLED POWER FOR RESEARCH AND INDUSTRY

VIBRATION

...the enemy
of industry



Mechanical vibration waveforms can now be measured and analyzed with the greatest accuracy, using the revolutionary MUIRHEAD-PAMETRADA Model D-489 Wave Analyzer. Complex vibration waveforms can now be isolated and measured

within a wide frequency range, overcoming amplitude and frequency fluctuation and the proximity of component frequencies.

The MUIRHEAD Wave Analyzer operates as a negative feedback, tuned band-pass filter insuring constant selectivity at all frequencies, and simplifying frequency selection. Output voltage is available at tuned frequency for viewing or recording.

This highly versatile instrument has a wide diversity of applications in many industries: aviation, automotive and manufacturing, shipbuilding and electric power generation, to name only a few.

FEATURES

- No internal oscillator—eliminates drift
- R/C-tuned circuits—reduces hum and noise pickup
- Choice of 4 bandwidth characteristics: In-tune High, In-tune Medium, Narrow Band and $\frac{1}{3}$ Octave.
- High selectivity characteristic (1% bandwidth for greatest discrimination)
- Auxiliary pre-amp permits use of high-impedance pickups or transducers.

SPECIFICATIONS

- Frequency range—19 c/s to 21 kc (extendable down to 2 c/s)
- Frequency Stability— ± 1 db over several days
- Measurement Accuracy— $\pm 0.3\%$ over most of range
- Output Voltage—10 v
- Input Voltage—1 mv to 300 v rms (FSD)
- Input Impedance—0.1 megohms
- Hum and Noise Level—Equivalent to .05 mv input at maximum gain
- Power Supply (external)—100/120 v, 60 or 400 cycles, 130 w
- Dimensions—12 $\frac{3}{4}$ " x 13 $\frac{1}{2}$ " x 17 $\frac{1}{2}$ "
- Weight—55 pounds

Write TODAY for your FREE brochure on Vibration Measurement and Waveform Analysis.

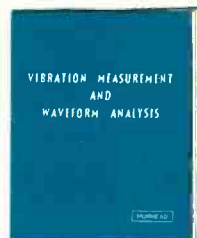

MUIRHEAD

MUIRHEAD INSTRUMENTS, Inc. 677 Fifth Ave., New York 22, N. Y.

United States Sales and Service for MUIRHEAD & CO., LTD. • Beckenham • Kent • England

INDUSTRY REPORT

electronics—November • 1955

Air Force Long-Distance Circuits Use VHF

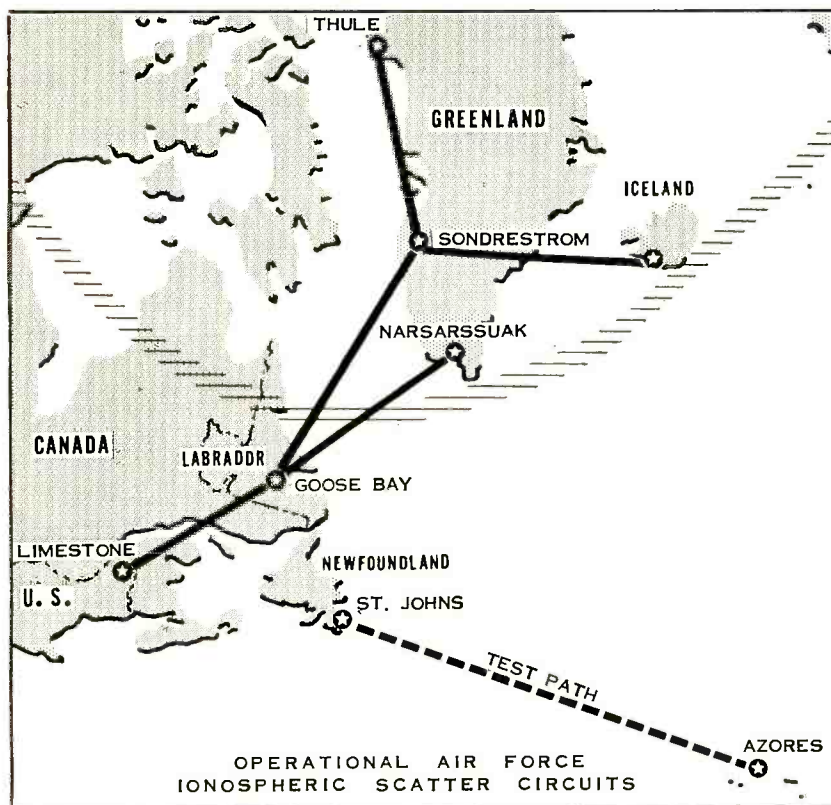

Forward scatter insures reliability of teleprinter communications in radio blackouts

PATIENT COMMUNICATORS have so far failed to establish reliable radio service in the arctic using conventional high-frequency techniques. Very low frequencies require large antennas and have insufficient bandwidth to accommodate multiplex circuits.

Fortunately, a phenomenon of the ionosphere (ELECTRONICS, p 102, June 1952) permits reception

of directional signals over distances between about 500 and 1,500 miles. The phenomenon is often known as FPIS (forward propagation by ionospheric scatter). With increased habitation of the far north by defense forces, use of the new technique becomes a necessity.

► **Bitter Sweet**—A three-channel duplex system called Bitter Sweet links Loring Air Force Base at Limestone, Me. with Thule AFB in Greenland. This joint project of the Air Force, National Bureau of Standards and Page Communica-

tions Engineers, Inc. of Washington, D. C., requires relay stations at Goose Bay, Labrador and Sondrestrom, Greenland.

► **Future Circuits**—Engineers feel that the potentialities of FPIS have not been anywhere near fully exploited. Besides solving problems of erratic radio signals in the arctic, the technique is less expensive when compared with the amount of high or low-frequency equipment required to do an equivalent job.

Recently declassified are two new circuits linking Goose Bay—Narsarsuaq and Sondrestrom—Iceland. This project is called Fat Girl and may include voice.

Europeans To Study U.S. Color-TV Standards

Large CCIR delegation coming to America in March. NTSC making arrangements

SOME 100 delegates of the Committee Consultatif International Radio (CCIR) will study American color-television standards, in the United States, in March. Arrangements for demonstrations, technical papers and plant visits are being made by the National Television Systems Committee (NTSC) of the Radio-Electronics-Television Manufacturers Association (RETMA) at the request of the State Department.

► **Two Weeks**—Recalling NTSC for

the purpose October 11, chairman W. R. G. Baker announced that CCIR delegates would participate in a program extending from March 5 through March 16. The first day will be devoted primarily to demonstrations at the United Nations building in New York, the balance of the first week to network, lab-

oratory and plant visits in and near the New York metropolitan area. The second week will take delegates to other cities.

Many delegates plan to remain in the United States for a third week, in order to attend the Institute of Radio Engineers' national convention.

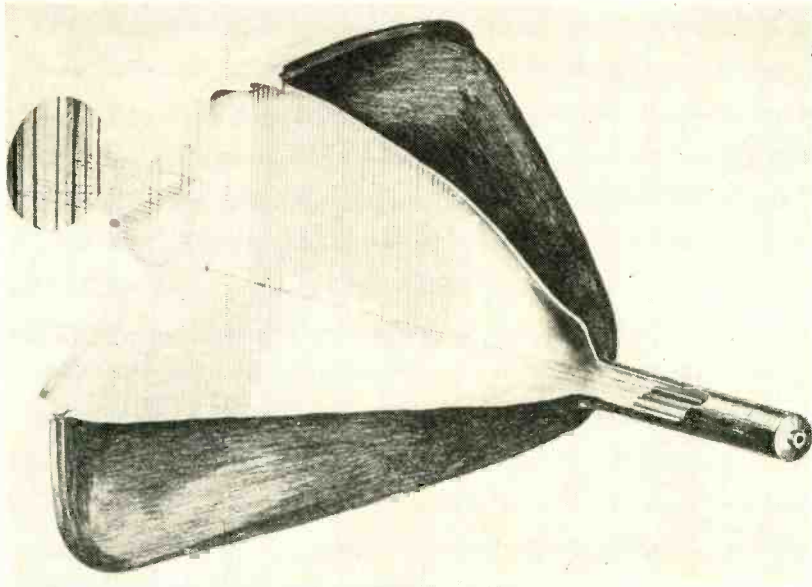

SKETCH of GE's post-acceleration tube shows how . . .

Color-Tube Design Progresses

Electron optical masking is done by grille wires that aid focusing also

PREVIEW of the post-acceleration tube was given by General Electric tube department in September. The company emphasized that the tube is still in the developmental stage and may not be ready for production until 1957.

► **Construction**—The post-acceleration tube has three electron guns. It uses direction selection near the screen to cause each of the three beams to strike the proper phosphor. The three guns lie in a horizontal plane.

The direction selection mechanism is an array of parallel 3-mil wires, spaced 28 to the inch, which form the color-selection electrode or grille. Close to the grille is the screen bearing a pattern of red,

blue and green phosphor lines.

The grille permits more than 90 percent of the electrons from the guns to strike the phosphor screen compared to 12-14 percent for the shadow-mask tube. The new tube is theoretically more than six times as bright as the mask type. GE demonstrated how the tube's extra brightness stands up under lighting conditions up to 275 foot-lamberts.

► **Voltage Saving**—In normal operation, the final gun-electrode and cone potentials of the new tube are held at about 6.5 kv. The grille is held at a potential approximately 200 volts lower than 6.5 kv and the phosphor screen is run at about 25 kv.

► **Disadvantages** — Because post acceleration is used along with only one grille, secondary electrons hit the screen in a random manner and

cause a white background. As a result, there is some loss of contrast. In a lighted room, however, the loss seems negligible.

► **Advantages**—The post-acceleration tube is expected to allow smaller, less complex deflection components, less driving power and fewer convergence adjustments. All of these would result in cost savings.

The yoke of the new tube, for example, uses 60 percent less copper than shadow-mask yokes. Savings are expected on 11 other items. Possible savings to set manufacturers range from 25 to 30 percent.

Industry Holds Share Of Defense Buying

Air Force becomes largest buyer of electronic and communications equipment

ELECTRONIC and communications equipment has accounted for 5 to 6 percent of total defense procurement for each fiscal year since 1951. It will retain about the same share during this year and next.

Total Defense Department expenditure for major procurement and production was about \$16 billion in 1954—5 percent below the 1953 peak. A drop to about \$12 billion is anticipated for 1955 with a slight upturn in 1956.

► **Breakdown**—Army electronics procurement peaked sharply in 1953. But the Army cut its ex-

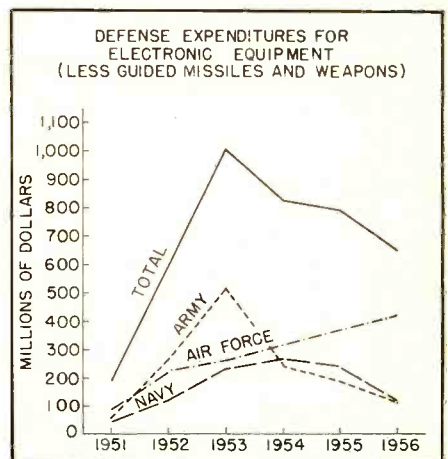

(Continued on page 10)

NEW

V.L.I.

(VERY LOW IMPEDANCE)

DIODE

up to 300 ma at 1 volt with excellent stability and fast recovery time

V.L.I. DIODE CHARACTERISTICS @ 25° C

	Reverse Current Microamps Max.					Max. Reverse Working Voltage	Max. Average Anode Current
Forward Current @ + IV ma min.	-10V	-30V	-50V	-100V	-150V	Voltage	ma
1N447	25	20	60			30	60
1N448	25		30	100		100	60
1N449	50	10	30			30	60
1N450	50		30	100		100	60
1N451	50				150	150	60
1N452	100		30			30	80
1N453	100		30	100		100	80
1N454	200			50		50	100
1N455	300		30			30	100

The new Sylvania V.L.I. Diode is a significant development for electronic equipment designers with applications for high current carrying diodes. For the first time, you can expect high forward conductance combined with stable, drift-free performance, and fast recovery time.

The new Very Low Impedance diode is the result of recent technological advances in the diode field by Sylvania research engineers. It's the ideal diode for demanding computer applications in clipper, clamper, and logical circuits. In fact, it's the only diode wherever you want high forward conductance with high back resistance—high current carrying capacity with fast recovery time—and high rectification efficiency. The V.L.I. diode is designed into the Sylvania sealed-in-glass package and is 100% inspected for a positive, protective seal.

There's a full line of V.L.I. Diodes in a range of current-carrying capacity. Write for complete information or samples. Address Dept. L20R.

"another reason why it pays to specify Sylvania"

SYLVANIA ELECTRIC PRODUCTS INC.
1740 Broadway, New York 19, N. Y.
In Canada: Sylvania Electric (Canada) Ltd.
University Tower Bldg., Montreal



SYLVANIA®

LIGHTING • RADIO • ELECTRONICS • TELEVISION • ATOMIC ENERGY

penditures in half during 1954.

The Navy showed no drop through last year. But some leveling off is expected in 1955 and 1956.

The Air Force has upped its buying every year, expects no cut.

► **Future**—The Air Force's spending will boost its proportionate share of defense electronic expenditures from 39 percent in 1954 to close to two-thirds in 1956.

This is a partial picture of military electronic procurement since equipment installed as integral components in aircraft, ships, com-

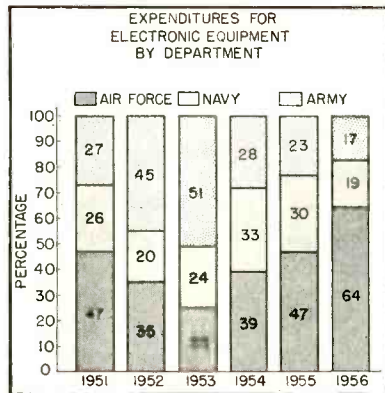

bat vehicles, guided missiles, ammunition and weapons is excluded.

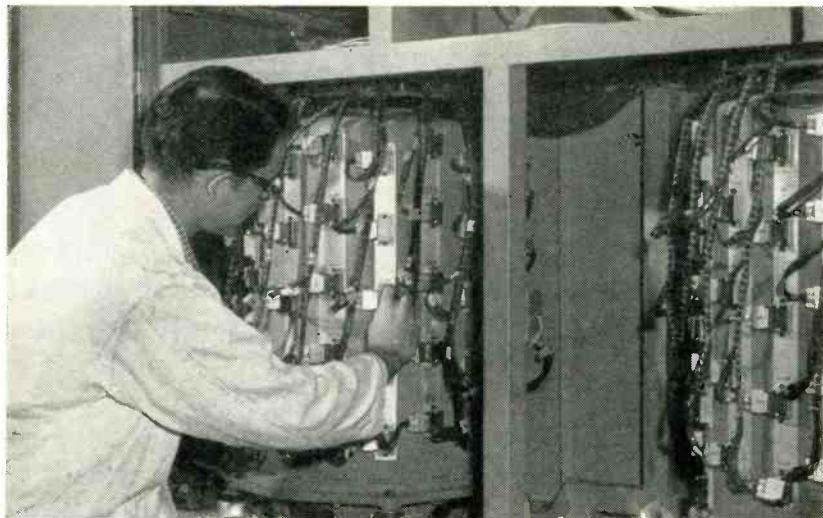

MAGNETIC drums service 50,000 checking accounts as . . .

Digital Computers Seek New Fields

Special-purpose machines vary in size. Jobs range from banking to bombing

ELECTRONIC digital computers, tailored to specific jobs, are making news in banking, atomic energy, rail transportation and national defense.

► **Overdrafts**—Electronic Recording Machine, Accounting, developed for the Bank of America by Stanford Research Institute, can service 50,000 checking accounts. Banks' friend ERMA identifies accounts by bars printed in magnetic ink on the backs of checks.

The bank plans to acquire 37

of the machines. ERMA credits deposits, debits withdrawals, maintains balances, accepts stop payments and prevents overdrafts. It prints statements at 600 lines per minute.

The computer uses 12 reels of magnetic tape besides the two drums shown. Nine operators are needed. The machine incorporates 34,000 diodes, 8,000 electron tubes, weighs 25 tons and consumes 80 kw.

► **Bombs Away**—A quarter-ton baby computer developed by IBM will be used by the Air Force to translate reconnaissance information into bombing data. The computer will undergo tests at Wright Air Development Center with a

view to placing small computers in the field at the squadron level.

► **King Sized**—Sperry Rand recently contracted with the Atomic Energy Commission's Livermore research laboratory for a computer known as the Univac-LARC. Priced at \$2,895,000, the machine will use only 120 electron tubes. A ferrite-core memory will provide storage capacity for 20,000 ten-digit numbers with read-write time of two microseconds per word. The king-sized Univac will be used in scientific computation.

► **Railroads**—The Santa Fe railroad will soon install reservation equipment manufactured by Tele-register to keep track of passenger space reservations in Chicago, Kansas City, San Francisco and Fort Worth. The machine uses magnetic drum storage. The Santa Fe is the third railroad to adopt electronic computers for reservation accounting.

FCC Asks Military To Give VHF Channels

Broadcasters and engineers submit plans to help economically floundering uhf-tv

UNPRECEDENTED action by Federal Communications Commission was a forthright request to Arthur Fleming, director of Office of Defense Mobilization, asking that he explore the possibility of releasing government channels for more vhf television.

Action was taken because the broadcasting industry has been unable to utilize more than a fraction of its television allocations potential. Lack of transmitter power and lack of receivers for uhf have brought with them lack of advertiser interest—particularly in markets served adequately by more powerful vhf transmitters.

► **Alternate Suggestions** — The Commissioners are united in seeking a solution but differ as to methods. Deintermixture, or allocations in one city of either vhf or uhf ex-

(Continued on page 12)

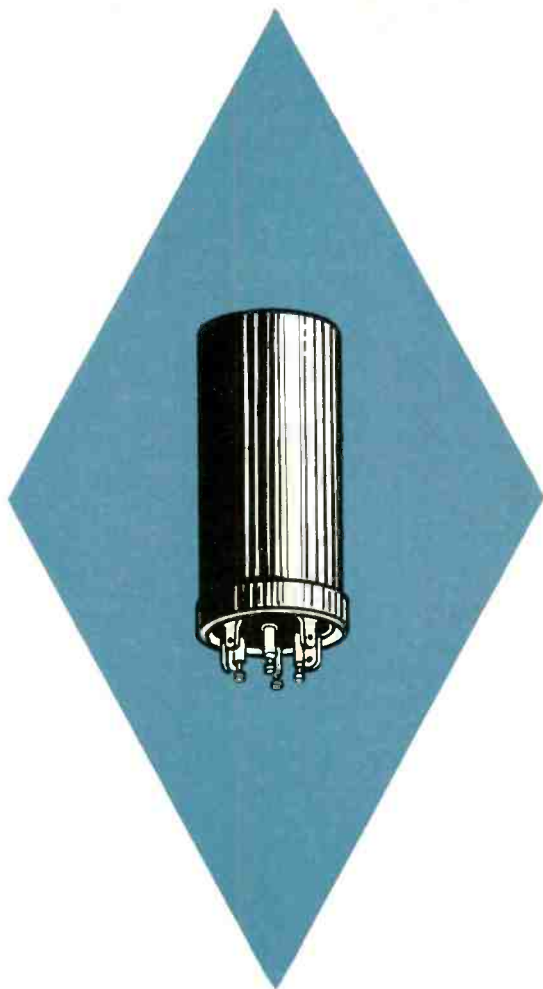

**“telephone
quality”*
electrolytic
capacitors**

now available for

military electronics

computers

laboratory test instruments

industrial controls

other electronic applications

HERE ARE CAPACITORS OF THE SAME *MAXIMUM RELIABILITY* which Sprague has long supplied to the telephone systems . . . now available for your own high reliability electronic applications.

The use of especially high purity materials . . . utmost care in manufacture, constant observation and quality control of all operations have made Sprague Telephone Quality Capacitors outstanding for their long life and faultless performance.

Type 17D Telephone Quality Electrolytics have turret terminals and twist-mounting lugs. A special vent construction is molded right into the cover, as are the numbers identifying each terminal. The aluminum cans are covered with a corrosion-resisting insulating coating.

Nineteen standard ratings, all characterized by low maximum leakage current and remarkable life test capabilities are available in the new series. Complete technical data are in Engineering Bulletin 340, available on letterhead request to the Technical Literature Section, Sprague Electric Company, 35 Marshall Street, North Adams, Massachusetts.

**Long synonymous with the ultimate in quality and dependability*

SPRAGUE®

world's largest capacitor manufacturer

Export for the Americas: Sprague Electric International Ltd., North Adams, Massachusetts. CABLE: SPREXINT.

clusively, is not generally popular but could be handled by FCC alone.

CBS has suggested vhf drop-ins (departures from present allocations) to give 100 top markets at least three equal facilities and some deintermixing. Also suggested is a plan to eliminate uhf.

ABC proposes deintermixture plus drop-ins. Other petitions are already pending. It has also been

suggested that geographical spacing of stations be reduced, although some engineers feel that interference will result.

A new allocations committee, headed by W. R. G. Baker, has been set up by RETMA to study the whole problem, while the Senate Commerce Committee has appointed Edward Bowles to work at a separate solution.

Bundling Cuts Cost Of Short-Run Assemblies

New module permits frequent changes in product design with minimum tool cost

ELECTRONICS assembly technique, announced by Eastman Kodak Co., involves arranging axial-lead components in compact bundles located between pairs of etched wiring boards. Advantages include ruggedness and reliability, minimum restriction on electronic and mechanical package design and inherent flexibility that holds production costs down even when product designs must be changed frequently.

► **Manual Assembly**—The operator places two etched wiring boards for a Paraplate bundle in a bench-type holding fixture. Leads of components are cut slightly longer than the distance between boards, then bent to permit insertion of one lead in each board. Straighten-

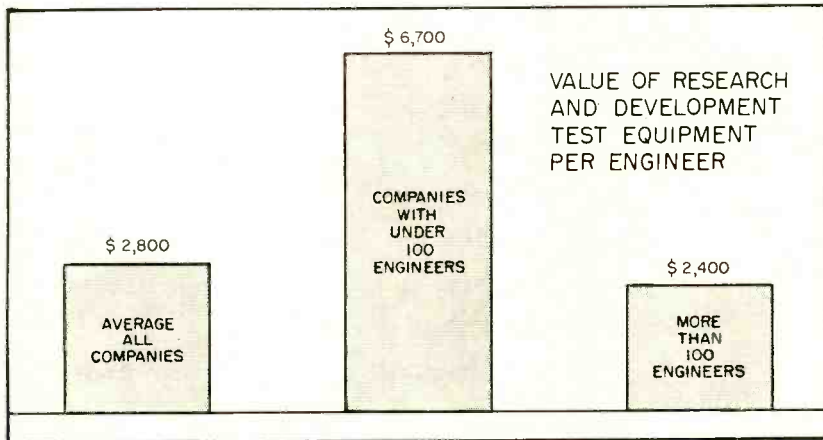

Research Buys Testing Gear

Spending averages \$2,800 per engineer. Small companies spend 2½ times as much

ENGINEERS and their company purchasing agents take a lively interest in how much test equipment is desirable or necessary to carry out a research and development program. A recent survey by the editors of ELECTRONICS indicates that the engineer has access, on the average, to \$2,800 worth of test instruments.

If he works for a large company employing more than 100 engineers, the average dollar value of his gear may be lower, about \$2,400. Overall, however, there is likely to be a greater range and quantity available in a big lab. Companies with less than 100 engineers have an average investment of \$6,700 per engineer.

► **Government Equipment**—Of the companies replying to questionnaires, several indicated that they possessed no government-owned equipment. On the average, how-

ever, there was more than half again as much of Uncle Sam's test gear that can be used only on the specific government project for which it was furnished. Government equipment has not been included in any of the averages shown on the chart.

Inventories of test equipment are generally made once a year, although some companies prefer six-month checks. A few indicate that they inventory either every month or continuously.

Depreciation is generally figured on the basis of 20 percent a year. Some equipment with long life is depreciated as low as 3 to 5 percent whereas a few rapidly obsolescing items are written off at 33½ percent a year.

► **Home Grown**—Most research and development test equipment is purchased, although as high as 20 percent (in dollar value) may be made by a company itself for special use. In striking contrast are a few companies who buy only 20 percent and make 80 percent themselves.

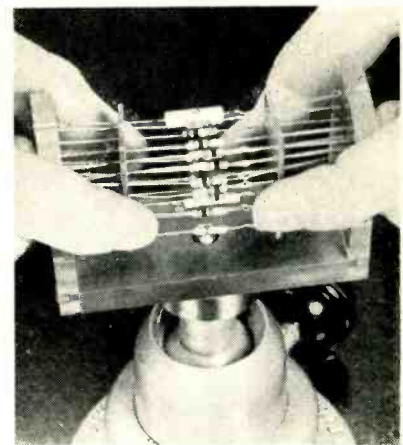

Pushing boards together after installation of components

ing leads after insertion prevents the component from falling out while others are inserted.

When all parts have been installed, the boards are pushed up to the components and inserted in a tool that dips first one board and then the other in molten solder. Trimming projecting leads completes the assembly. Leads needed as external terminals can be left longer than the others.

(Continued on page 14)



- ★ CUT CORES, Types C and E
- ★ TOROIDAL CORES, Cased and Uncased
- ★ BOBBIN CORES

It's **ARNOLD** for **EVERYTHING** in **TAPE-WOUND CORES**

Applications

Let us help you with your core requirements for Pulse and Power Transformers, 3-Phase Transformers, Magnetic Amplifiers, Current Transformers, Wide-Band Transformers, Non-Linear Retard Coils, Reactors, Coincident Current Matrix Systems, Static Magnetic Memory Elements, Harmonic Generators, etc.

For Complete Details

Write for Bulletins:

- ★ SC-107—Cut Cores, Types C and E
- ★ TC-101A—Toroidal Cores, cased and uncased
- ★ TC-108—Bobbin Cores

ADDRESS DEPT. E-511

MATERIALS: Deltamax, 4-79 Mo-Permalloy, Supermalloy, Mumetal, 4750, Monimax, Silectron, Permendur: all are available for tape wound core applications. The choice of material will depend upon the specific properties required.

GAUGES: The following standard tape thicknesses are available for Arnold tape wound cores in most of the magnetic materials mentioned above: .012", .004", .002", .001", .0005", or

.00025". Bobbin cores are made from tape .001" to .000125" thick.

SIZES: Cores weighing from a fraction of a gram to many hundreds of pounds can be supplied. Toroidal cores are made in 27 standard sizes with nylon cases. Types "C" and "E" cut cores are made in a total of 530 standard sizes. Many special sizes and shapes of both gapless and cut cores are manufactured for unusual requirements. ● *Let us work with you.*

W&D 5818

THE ARNOLD ENGINEERING COMPANY



SUBSIDIARY OF ALLEGHENY LUDLUM STEEL CORPORATION

General Office & Plant: Marengo, Illinois

DISTRICT SALES OFFICES . . . New York: 350 Fifth Ave.

Los Angeles: 3450 Wilshire Blvd.

Boston: 200 Berkeley St.

► **Mechanized Assembly**—As now planned, an automatic insertion head would duplicate the steps in manual assembly. A four-jaw head would pick up a component, cut, bend, insert and unbend. The boards in their cradles would be carried from station to station of the in-line assembly machine, stopping at

each head to receive a component. Assembled bundles would be transferred automatically to the dip-soldering machine. It is estimated that a 40-head machine equipped with suitable short-run component programming could be completely changed over for a new design in less than 15 minutes.

Radio Replaces Cables



Changes in timing of traffic signals during rush hours will speed Chicago vehicles with greater safety. First step in the new program will be installation of radio-controlled intersection units like the one under test by GE engineers. Cost of sufficient interconnecting cables would be prohibitive. Coded radio signals are used instead

Transistor's Future Looks Bright

Manufacturer sees unit volume exceeding 15 million in 1957 with 1 to 5-mc units important

PICTURE of what may come in the transistor field was reported recently by one manufacturer.

► **Volume**—The company feels that in 1955 about 1.5 million transistors will be sold. For 1956 it expects volume almost to double, going to 2.5 or 3 million units. It sees 1957 as the first mass volume year for the business and predicts that over 15 million units will be sold.

► **Markets**—In 1956, about 1.5 million transistors are expected to go into portable radios, a half million into computers and 750,000 into hearing aids. Although transistor auto sets will be available in 1956, this market may not become substantial until 1957 when a number of hybrid auto sets, using both transistors and tubes, will bow.

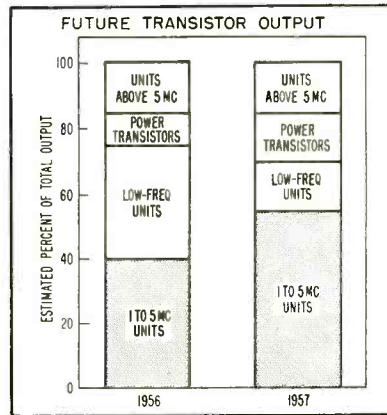

► **Types**—The firm expects both power transistors and the 1 to 5-mc units to garner a bigger share of the total market in 1957 than in 1956. It expects units of 5-mc and above to maintain a fair share of total output but sees low-frequency units dropping sharply. As for silicon transistors, the company expects that it may be 1958 before annual output exceeds a million.

Build-It-Yourself Computer Appears

Other analogs simulate lightning and assist utilities to plan networks

DO-IT-YOURSELF has caught up with the computer business or vice versa.

The Heath Co., a Daystrom subsidiary, is selling an analog computer in kit form aimed at industry and the universities. The computer includes d-c operational amplifiers, power supply, initial-condition power supplies and function generator. The d-c amplifier contains three tubes.

► **Network Analyzer**—At the opposite pole pricewise is a half-mil-

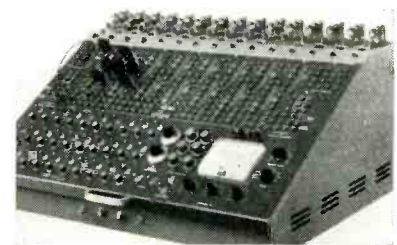

Heath computer made from kit

Machine Makers Go Electronic

Tool companies enter field to design their own control systems

MACHINE TOOL manufacturers are going into the electronics business and a few electronics companies are invading the machine-tool field. Thirteen companies are offering machine tools equipped with computer-type electronic controls. Five are machine-tool manufacturers who have set up their own electronics sections to develop the equipment.

Two of the thirteen companies

are primarily in the electronics and instrumentation field and have stepped into the tool field to market their drill-positioning equipment. The remaining companies have combined their production equipment with controls supplied by electronics firms.

► **Methods**—Automatic positioning of the workpiece and selection of tool speed and cutting rate are the major control applications. Dimensional data taken from blueprints is supplied on tape or punch cards to a computer. The computer output then drives servos.

(Continued on page 16)

KÄHLE

automatic machines

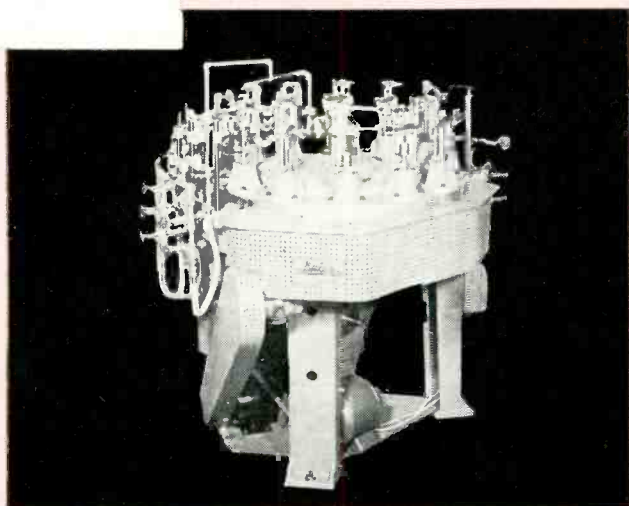
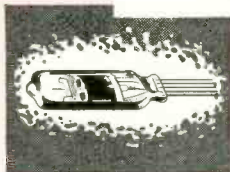

SUBMINIATURE TUBE BUTTON STEM MACHINE NO. 1384

ARE PRODUCING

subminiature tubes

DIODES, TRANSISTORS AND
TUBE COMPONENTS...
FASTER,
MORE ECONOMICALLY.

Write today — tell us your requirements or problems.

Kähle ENGINEERING COMPANY

1310 Seventh Street North Bergen, New Jersey

©NTI

DESIGNERS AND BUILDERS OF AUTOMATIC AND SEMI-AUTOMATIC EQUIPMENT FOR ALL INDUSTRIAL OPERATIONS

lion-dollar network analyzer presented to Syracuse University by Niagara Mohawk Power Co., New York State Electric and Gas Co. and GE. The computer solves problems relating to power trans-

mission and electrical distribution.

► **Lightning**—A desk-size analog computer installed at Westinghouse's transformer division, Sharon, Pa. will permit studying

effects of lightning surges on electrical apparatus. This will permit design of transformers so as to avoid costly damage to their innards when lightning strikes the equipment.

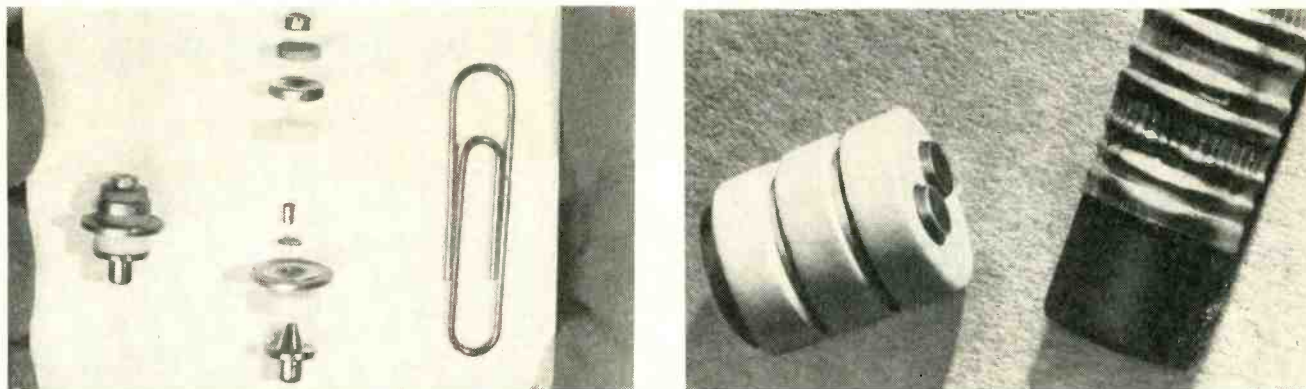

EXPLODED view of the developmental L-54 triode announced at Syracuse (left) and magnified commercial version of the 6BY4 triode (right) show what happens when . . .

New Materials Evolve New UHF Amplifier Tubes

Titanium and ceramic used for uhf-tv triode amplifier to speed automatic assembly

LATEST HOPE for an inexpensive uhf television radio-frequency amplifier stage resides in General Electric's microminiature ceramic type 6BY4 triode. Looking more like a bracelet charm than a serious electronic device, the new tube is about $\frac{3}{8}$ inch long and $\frac{1}{8}$ inch in diameter.

Besides its favorable technical qualifications (see p 176) it is interesting because of its constituent materials. All metal parts are titanium—a metal that absorbs gases rather than liberating them. New ceramics used as insulators can also be heated to high temperature without releasing enough gas to poison the tube's operating characteristics.

► **Military Applications**—With its component parts all in the form of circles, the new tube should be a natural for automatic assembly. Engineers say that it may take them another year and a half, however, to make a production-line item of the military version.

J. E. Beggs described to RETMA engineers meeting in Syracuse the development of a similar tube known as the L-54. Used as an oscillator, it has operated up to 10,-

700 mc. Tubes of this type have functioned at temperatures as high as 700 C. Such behavior qualifies them for difficult roles in guided-missile and similar tasks.

Industry Continues to Grow

Most segments of the electronics industry have grown in number of firms

MANUFACTURERS of electronic equipment, components and hardware totaled 3,600 at the beginning of 1955 according to the Electronics Production Resources Agency. Of these firms, 1,000 produced end equipment or major subassemblies. Component manufacturers totaled 2,000 while the remaining 600 companies produced hardware such as antennas and wiring harnesses.

► **Growth**—Since 1939, the number of firms producing equipment in the seven categories listed in the chart has increased fivefold. In 1939, there was a total of 373 firms; in 1944, 559; 1952, 1,254 and in 1955, 1,555.

Since 1952, the manufacturers of

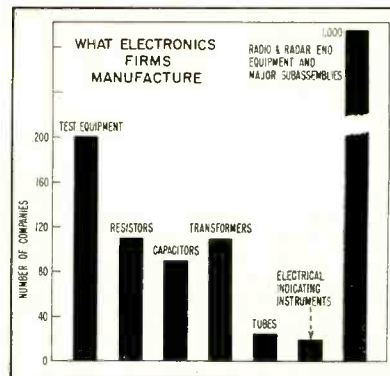

test equipment have grown by 20 firms, transformer manufacturers have increased by 5 companies, capacitor makers by 30 companies, tube firms by 6 and radio and radar equipment and major subassemblies manufacturers by 150 firms. The only one of the seven categories to show no growth was the electrical-indicating-instruments field

(Continued on page 20)



NEW! Capacitance-Type FUEL GAUGE TESTER

for Jet or Propeller Aircraft

★ High Calibration Accuracy

★ Built to MIL-T-8579 Specifications



The **Type P-579 Fuel Gauge Tester** meets the need for an accurate system for calibrating modern-day, capacitance-type aircraft fuel gauges. The vital importance of reliable readings by fuel gauges for aircraft is self-evident. Every fuel gauge must be carefully adjusted in each new airplane, and checks for reliability must be made at routine intervals afterwards.



For use with jet aircraft, the test equipment must make provision for calibrating both the main sensing capacitor and the compensating capacitor in the fuel gauge system. The latter capacitor compensates for variations existing in the composition of jet fuel and also reduces the error introduced by changes in the temperature of the fuel. The composition of aviation gasoline does not vary appreciably and as a result compensation is not required.

The Type P-579 Fuel-Gauge Tester offered by the General Radio Company takes all the above needs into account. It is currently the only self-contained equipment suitable for calibrating fuel gauge systems installed in both jet and reciprocating-engine aircraft.

The Type P-579 Fuel-Gauge Tester is the commercial version of the Military Type MD-1 Calibrator manufactured by G-R. Specifications for the MD-1 were established by the Wright Air Development Center of the Air Research and Development Command. The heart of the instrument is the well-known General Radio precision-variable air capacitor.

The Air Force wanted the utmost accuracy built into this important test equipment. G-R was a logical supplier because this Company's trademark is synonymous with the best in precision electrical standards.

Today's high-grade fuel gauges employ capacitance sensing elements located in the airplane fuel tanks. The actuating means is the variation in capacitance occurring as a result of the replacement of air dielectric between the capacitor plates by aircraft fuel. In common practice, a 400-cycle transformer bridge (see typical aircraft fuel-gauge circuit below) is used to transform the change in capacitance to a reading on the fuel indicator located on the aircraft control panel. A phase-sensitive motor drives the fuel gauge needle. The motor also adjusts the position of a balancing potentiometer across one arm of the bridge making this a self-balancing device.

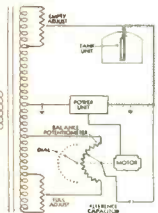

Type P-579 Fuel Gauge Tester
Supplied with wide variety of connecting cables for calibrating modern aircraft fuel-indicating systems.

The Type P-579 Fuel Gauge Tester consists essentially of two G-R Precision Variable Capacitors which can be accurately set to simulate the capacitance existing across the fuel gauge sensing elements. By adjusting the Tester's precision capacitor to the same value of capacitance known to exist across the sensing element when fuel tanks are full, and noting whether the control-panel indicator reads "full", one has an accurate and convenient means for checking performance of the fuel gauge (similar procedure for checking "empty" readings). If readings are incorrect, the "full adjust" and "empty adjust" potentiometers can be repositioned until the dial indicates correctly.

GENERAL RADIO Company

275 Massachusetts Avenue, Cambridge 39, Massachusetts, U. S. A.

94 West Street NEW YORK 6
8055 13th St., Silver Spring, Md. WASHINGTON, D. C.
1150 York Road, Abington, Pa. PHILADELPHIA
920 S. Michigan Ave. CHICAGO 5
1000 N. Seward St. LOS ANGELES 33



Please send complete information on the G-R Fuel Quantity Gauge Tester

Name..... Title.....

Company.....

Street.....

City..... Zone..... State.....

Dependability

in guided missile,
military and all other
critical applications means

RAYTHEON
RELIABLE

SUBMINIATURE
TUBES

RAYTHEON
MANUFACTURING CO.

Special Tube Division — Home Office: 55 Chapel St.,
Newton 58, Mass., B1gelow 4-7500

For application information
write or call the Home Office
or: 9501 Grand Avenue,
Franklin Park (Chicago), Ill.,
TUxedo 9-5400

589 Fifth Ave., New York 17,
New York, PLaza 9-3900
622 South La Brea Ave.,
Los Angeles 36, Calif.,
WEbster 8-2851



Excellence in Electronics

RAYTHEON MAKES ALL THESE:

RELIABLE SUBMINIATURE AND MINIATURE TUBES
SEMICONDUCTOR DIODES, POWER RECTIFIERS AND
TRANSISTORS • NUCLEONIC TUBES
MICROWAVE TUBES • RECEIVING AND PICTURE TUBES

Raytheon Reliable Subminiature Tubes Now Available

TYPE	DESCRIPTION	Vibration Output mVac* (max.)	TYPICAL CHARACTERISTICS								
			Heater		Plate		Grid Volts	Screen		Amp. Factor	Mut. Cond.
			Volts	mA.	Volts	mA.	or Rk	Volts	mA.		
CK5639	Video Amplifier Pentode	100	6.3	450	150	21	100 ohms	100	4	—	9000
CK5702WA	RF Amplifier Pentode	50	6.3	200	120	7.5	200 ohms	120	2.6	—	5000
CK5703WA	High Frequency Triode	10	6.3	200	120	9.4	220 ohms	—	—	25.5	5000
CK5744WA	High Mu Triode	25	6.3	200	250	4.2	500 ohms	—	—	70	4000
CK5783WA CK5783WB	Voltage Reference	50	Operating voltage approximately 86 volts between 1.5 and 3.5 ma.								
CK5784WA	RF Mixer Pentode	100	6.3	200	120	5.2	-2	120	3.5	—	3200
CK5787WA	Voltage Regulator	50	Operating voltage approximately 98 volts between 5 and 25 ma.								
CK5829WA	Dual Diode	—	6.3	150	Max. I _o = 5.5 ma. per plate						
CK6021	Medium Mu Dual Triode	50	6.3	300	100	6.5	150 ohms	—	—	35	5400
CK6111	Medium Mu Dual Triode	50	6.3	300	100	8.5	220 ohms	—	—	20	5000
CK6112	High Mu Dual Triode	25	6.3	300	100	0.8	1500 ohms	—	—	70	1800
CK6152	Low Mu Triode	25	6.3	200	100	10.0	270 ohms	—	—	17.5	5100
CK6247	Low Microphonic Triode	2.5	6.3	200	250	4.2	500 ohms	—	—	60	2650
CK6533	Low Microphonic Triode	1.0	6.3	200	120	0.9	1500 ohms	—	—	54	1750

*At 40 cycles, 15 g.

Note: All dual section tube ratings (except heater) are for each section.

Announcing



A COMPLETE LINE OF

BONDED SILICON DIODES

TYPICAL REVERSE VOLTAGE CHARACTERISTICS AT 25°C.

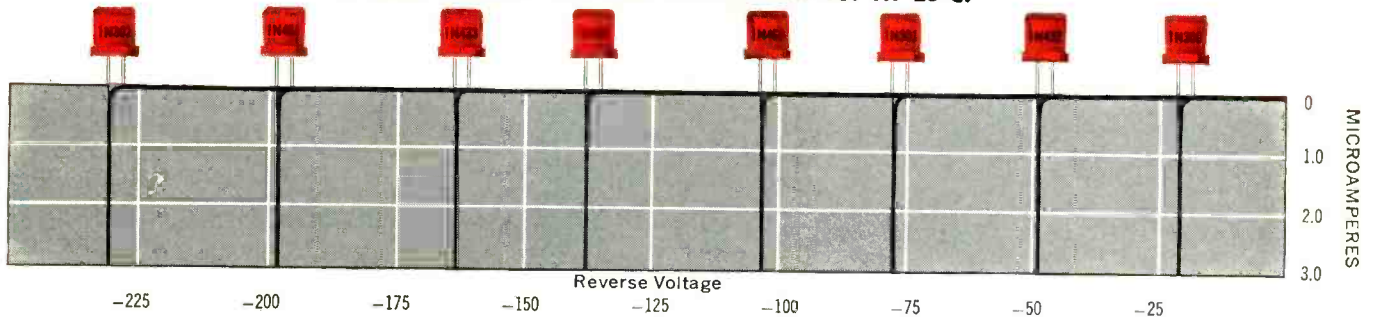

TYPICAL REFERENCE DIODE CHARACTERISTICS

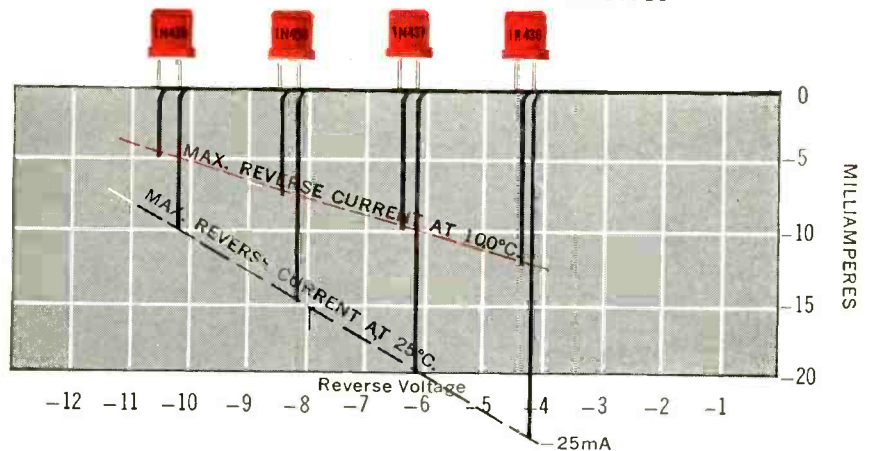

Raytheon Bonded Silicon Diodes with reverse voltage ratings from 3.0 to 225 volts are just what you are looking for whenever the application calls for low reverse current and good stability at high temperature. Every diode receives four temperature cycles of one hour at -55°C and one hour at $+150^{\circ}\text{C}$, followed by thirty-six hours at 95% relative humidity and 70°C . Exact characteristics are maintained after temperature cycling and stability remains excellent over long periods.



**RAYTHEON
MANUFACTURING
COMPANY**

Semiconductor Division

Home Office: 55 Chapel St., Newton 58, Mass., Bigelow 4-7500

For application information write or call the Home Office or:
9501 Grand Ave., Franklin Park (Chicago), Ill., TUxedo 9-5400
549 Fifth Avenue, New York 17, New York, PLaza 9-3900
622 South La Brea Ave., Los Angeles 36, Calif., WEbster 8-2851

RAYTHEON MAKES ALL THESE:

RELIABLE SUBMINIATURE AND MINIATURE TUBES • SEMICONDUCTOR DIODES, POWER RECTIFIERS AND TRANSISTORS • NUCLEONIC TUBES • MICROWAVE TUBES • RECEIVING AND PICTURE TUBES

which has stabilized at 20 companies.

► **Dollars**—According to EPRA, about 50 manufacturers account for over 80 percent of the dollar volume of end-equipment production. The major producers of components number between 150 and 200 firms. Although about 200 firms manufacture test equipment, 20 firms pro-

duce over 80 percent of the dollar value.

For other components, the number of firms estimated by EPRA to have predominated in production at the start of 1955 were: resistors, 23; capacitors, 25; transformers, 18; tubes, 10; meters and indicating instruments, 10. EPRA figures are made available through RETMA.

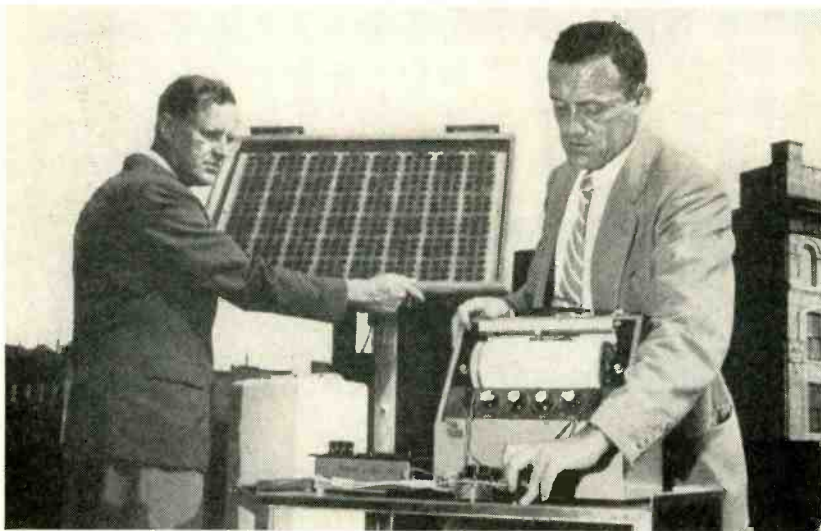

SOLAR battery developed by Bell Laboratories gets final tests before shipment.

Sun Powers Telephone Line

Silicon cells and transistors team up with the sun to power rural telephones

SUNLIGHT is furnishing power to a rural telephone system near Americus, Georgia as part of experiments being conducted by Bell Laboratories. The solar battery being used for the trial is encased in an aluminum housing less than a yard square. It contains 432 silicon cells. Technical details are given on p 178.

► **Charges Battery**—The silicon cells used in the battery are wafer-thin disks about the size of quarters. Excess current from the solar unit, not needed for immediate telephone use, is fed into a storage battery that powers the phones at night or in bad weather. Since the system under trial uses transistors

instead of vacuum tubes, only small amounts of power are required to operate it.

► **How Made**—The silicon cells used in the sun battery are produced by introducing impurities into thin slices of high-purity silicon at high temperatures under gas.

This is done at a precise rate to reach a depth of less than one ten thousandth of an inch.

► **Use**—The new rural system being used allows several conversations to be sent simultaneously over a single pair of wires. Each conversation is sent at a different frequency as has been done for years on longer distance calls. The system on trial at Americus, however, operates economically over shorter distances than have previously been used.

Defense Is Big Business In Canada

THE following contracts were awarded by the Canadian Department of Defense Production, to the electronics industry in Canada during July, 1955 according to RETMA of Canada. The list includes only those contracts in excess of \$10,000 and does not include contracts classified for security reasons or amendments to contracts:

Company	Amount
Collins Radio	\$2,105,812
Computing Devices	98,607
Hallicrafters	16,129
Measurement Engineering	33,275
Northern Electric	252,160
Canadian GE	25,581
Electromechanical Products	48,955
Electronic Labs	10,690
Muirhead Instruments	60,986
Northern Electric	79,003
Standard Telephones & Cables	16,348

Electronics Grows In Massachusetts

Number of companies in the state increases almost 50 percent in three years

SURVEY completed in September by Associated Industries of Massachusetts counted over 450 electronics firms compared to about 300 firms accounted for in its 1952 survey. Less than four percent of the companies surveyed in 1952 have gone out of business since then and their number has been augmented manyfold by new firms started since 1952.

► **Location**—The industry is concentrated in the greater Boston area with an estimated 90 percent of the plants located from Worcester eastward. However, nearly every section of the state has some part of the industry.

One thriving center is along highway route 128. Following is a list of most of the electronics firms located along the route: CBS-Hytron, Bomac Laboratories, Sylvania, Vectron, Sylvania electronics systems division labs, Electralab and Polaroid Corp. Under construction are plants for Tracerlab, Tran-

(Continued on page 22)



**IMMEDIATE DELIVERY
on a NEW TUBELESS!**

MAGNETIC AMPLIFIER

AC LINE VOLTAGE REGULATOR



MODEL MLR - 1000

1 KVA

- ☆ **NO TUBES TO REPLACE**
- ☆ **NO MOVING PARTS**
- ☆ **NO VIBRATING CONTACTS**
- ☆ **REGULATES RMS VALUE**
- ☆ **IDEAL FOR UNATTENDED INSTALLATIONS**

Specifications...

- **Input Voltage Range:** 95 to 135 volts
- **Output Voltage:** Nominal 115 volts, can be adjusted from 110 to 120 volts.
- **Output Current:** 8.5 amperes
- **Regulation Accuracy:** $\pm 0.25\%$ for any combination of line or load
- **Frequency Range:** 60 cycles $\pm 10\%$
- **Wave Form Distortion:** 3% maximum
- **Power Factor Range:** 0.5 lagging to 0.9 leading
- **Response Time:** 0.2 sec.
- **Maximum Load:** 1.0 KVA
- **Ambient Temperature Range:** Up to 45° C.
- **Dimensions:** 19½" wide x 11" high x 11½" deep (cabinet)
19" wide x 10½" high x 11½" deep (rack panel)
- **Mounting:** Cabinet or 19" Rack Panel
- **Finish:** Gray Hammertone
- **Weight:** 85 lbs.

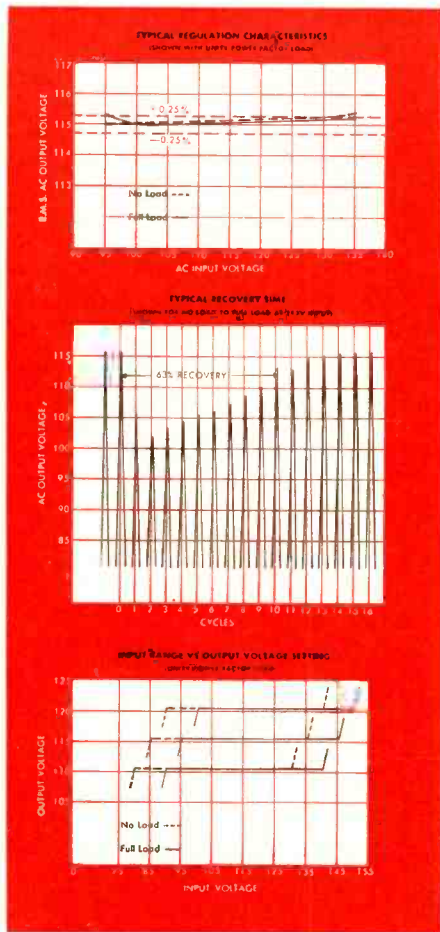

For **PROMPT REPLY**, wire the factory collect or phone our nearest sales office.

- New York City: HUnter 2-7784
- Philadelphia: NOrristown 5-2600
- Chicago: DIversey 8-6885
- St. Louis: DElmar 7701
- Kansas City, Mo.: JEFFerson 7221
- Dallas: FOrrist 8-8306
- Denver: MAIn 3-0343
- San Francisco: ULmar 1-7129
- Syracuse: 2-1167
- Pittsburgh: WAInut 1-2959
- Minneapolis: MIldway 4-7884
- Seattle: MOhawk 4895
- Albuquerque: 5-9632
- Los Angeles: SYcamore 8-5790



Write for Bulletin MLR 1000

PERKIN ENGINEERING CORP.
345 KANSAS ST. EL SEGUNDO, CALIF. PHONE: OREGON 8-7215

sonics, Donnelly Division of the Indian Company and Mason-Neilan Regulator Co. Planning to build are: High Voltage Engineering, United-Carr Fastener and Kendall Controls Corp. In the state as a whole, some 50 companies have built new plants or have them under construction.

► **High-Gear**—Pace of electronic product development in Massachusetts was also indicated in the survey. Total of 102 companies reported the introduction of 1,742 new products in last three years.

► **Why**—To learn why New England is attractive to the industry, the Federal Reserve Bank of Boston surveyed firms in the area in 1953. Most of the companies, 51, listed the supply of skilled labor as the chief advantage while 28 listed accessibility of materials and supplies; 24, availability of research and engineering; 22, nearness to customers and markets; 15, center of electronics business; 15, climate, living and working conditions; 12, high quality of labor and 12, nearness of residences of personnel.

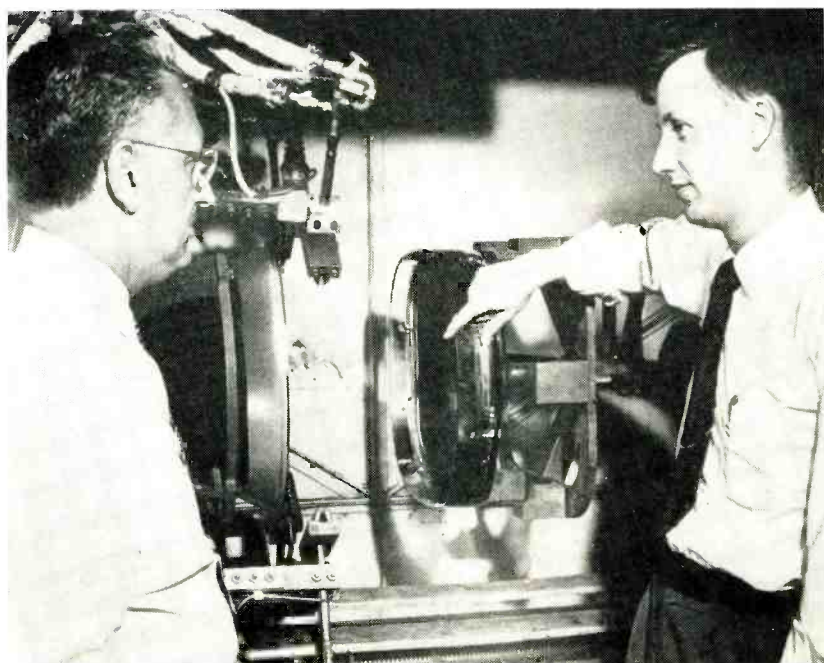

FACEPLATE with mask can be sealed directly to glass cone as . . .

Color Bulbs Go Conventional

All-glass 22-inch rectangular bulb uses solder-glass seal instead of metal joiner

SHADOW MASK color picture tube that uses an all-glass 22-inch rectangular envelope has been produced by the Westinghouse tube division. The bulb, since it uses no metal flanges, requires only the usual insulation of a black and white tube and high-voltage contact buttons.

► **Method**—With the new envelope, the phosphor is deposited on the

faceplate which is then aluminized. The shadow mask is attached to the faceplate by a simple technique. A low-temperature solder-glass seal is used to seal the face plate to the funnel after insertion of the components. It replaces the metal joiner.

By applying heat to the glass seal, the cone may be separated from the face plate at any time so that working parts can be removed for repair. Mass commercial production of the color television tube envelope is expected in the first quarter of 1956.

Electronic Headlight Dimmers Make Gains

Although the field is still small, indications are that sales will move ahead

AUTOMATIC electronic headlight dimmers have been on the market for a number of years now but have yet to become a fast-selling automobile accessory. However, the extra push for safety that the auto industry is now emphasizing, plus new developments in dimmers themselves may help push the business ahead.

► **Users**—Installations of General Motors' Autronic eye in the first nine months of 1953 ranged from 26 percent of total auto production for one division to lesser amounts for the others. Although figures have not been revealed it is believed that the percentage has increased.

Studebaker-Packard may have dimmers available for its 1956 models. Other car manufacturers are considering dimmers as accessory units for 1956. Some dimmer manufacturers feel that the units will not be sold as original equipment on any large scale until 1957.

► **Unit**—Dynotron Corp. of Cleveland, Ohio, associated with Dickey Industries, makes the unit shown



Self-contained dimmer with pickup, amplifier and power supply in one package for both 6 and 12-volt car systems made by Dynotron

(Continued on page 24)

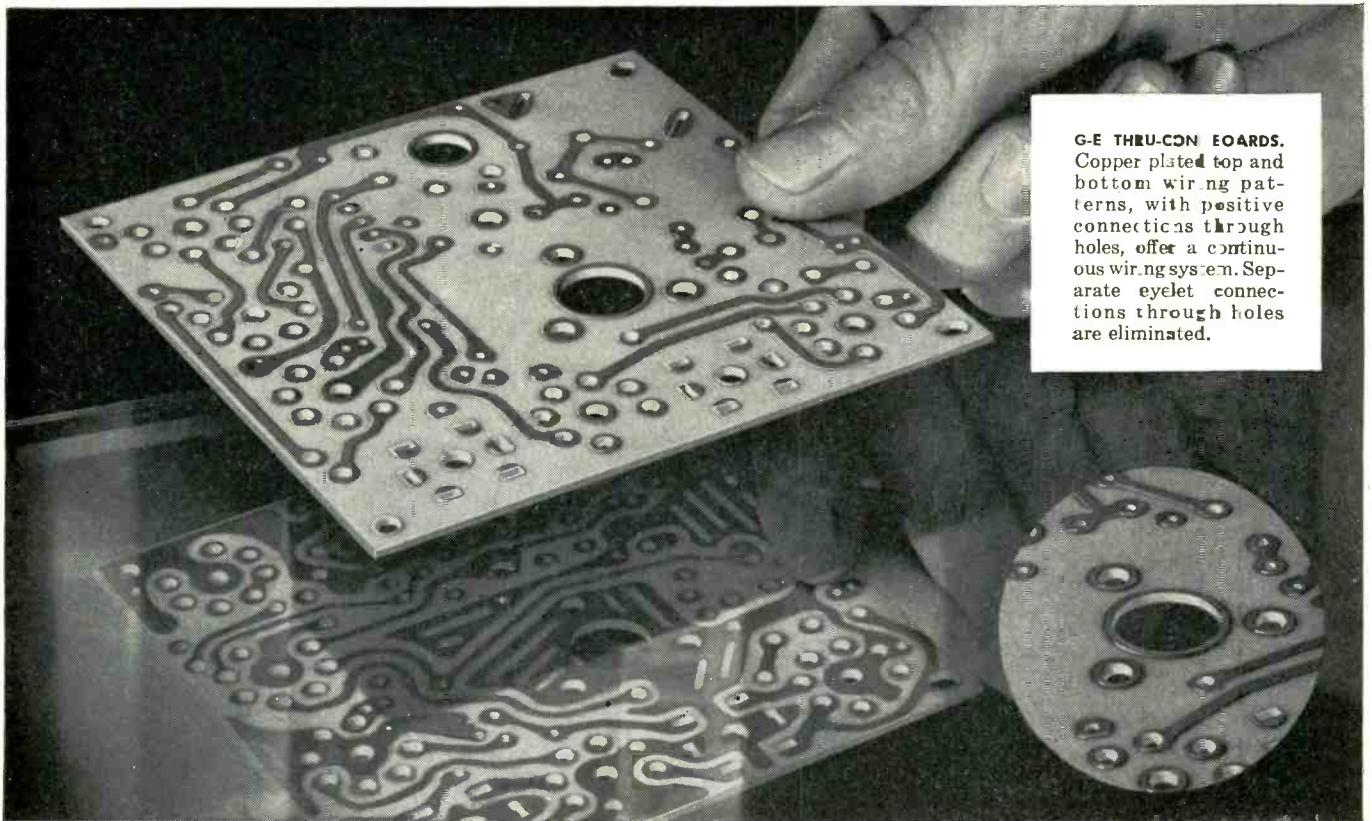

G-E THRU-CON BOARDS. Copper plated top and bottom wiring patterns, with positive connections through holes, offer a continuous wiring system. Separate eyelet connections through holes are eliminated.

G.E.'s Thru-Con Printed Circuit Boards have wiring patterns on two sides, positive connection through the board

Thru-Con Boards for printed circuitry lead to cost reductions, and product improvement in many industries

General Electric Thru-Con Printed Circuit Boards offer manufacturers of radio, television, and electronic equipment new opportunities to reduce production cost and substantially improve quality and performance.

G.E.'s Additive Method of Construction

Production techniques developed by G.E. provide two patterns on a single board with a positive through connection—without staking pins. Continuous copper plating through the holes insures positive solder filleting top and bottom, extreme strength, and trouble-free assembly.

Thru-Con In Many Industries

Widening usage in radio and TV receivers and street lighting controls has proven the advantages of printed circuits. G-E Thru-Con Boards not

only offer manufacturing savings, they also make it possible to reduce parts inventories, shorten assembly and inspection time, and save in weight and product size.

Investigate G-E Thru-Con Boards

Your company may be able to profit by using printed circuitry and G.E.'s Thru-Con Boards. The combination of wiring patterns, circuit designs, sizes or shapes, is virtually limitless. Experienced G-E printed circuit engineers and technicians are ready to aid you in developing a printed circuit program. For a discussion of your problem and a sample G-E Thru-Con Board, just call or write today to: *General Electric Company, Electronic Components Department, Section X4115, Auburn, New York.*



PORTABLE TELEVISION. Printed circuit board in this new receiver contains more than 50% of the wiring. Smaller chassis, yet full size screen. G-E Thru-Con Boards reduce assembly costs, slash receiver weight.

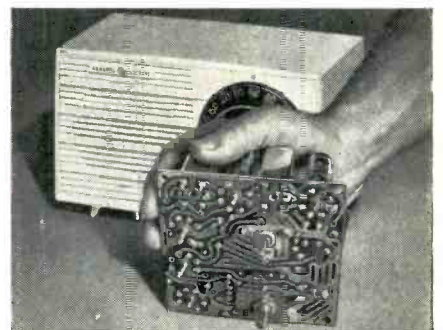

COMPACT, LOW COST RADIO. G-E Thru-Con Board permits compact chassis which slips into cabinet and plugs into speaker. Printed circuitry permits savings—cuts retail cost.

Progress Is Our Most Important Product

GENERAL  ELECTRIC

which is manufactured for both 6 and 12-volt electrical systems. It incorporates a photoelectric circuit with an electronic delay to eliminate flickering and improper return to upper beam after dimming.

The unit also operates from the tail lights of a car close ahead to prevent blinding its driver through the rear-view mirror. A small headlight relay mounts under the hood near the terminal block.

The firm plans to produce an additional model. Dynotron estimates that 1,000 of its electronic dimmers are now in use. The firm estimates potential sales for 1956 at 150,000 units with possibly a 300,000-unit volume in 1957.

► **Future**—A new automobile electronic headlighting system being developed at Battelle Institute in Columbus, Ohio casts a shadow over that portion of the road occupied by oncoming cars. This leaves normal, long-range light on the lane in which the equipped car is driving.

Transistor Transmitter Runs On Decibels

ENGINEERS of the Signal Corps Engineering Laboratories at Fort Monmouth, N. J. have come up with an experimental radio transmitter powered by the human voice. Present range of the unit is about 600 feet.

Further development is expected to increase this range to a mile and will likewise include construction



Technician tests output of voice-powered radio transmitter by watching waveforms of his voice on cathode-ray oscilloscope

of a companion receiver. This will be powered by stored energy from the voice and will be about the size of a matchbox.

► **Costs**—It is estimated that the

new transmitter can be produced for \$20. It uses a single transistor. After the speech energy strikes the microphone, part of it is rectified to provide power while the rest modulates the signal output.

Flat-Top Sounds Off With Tubes

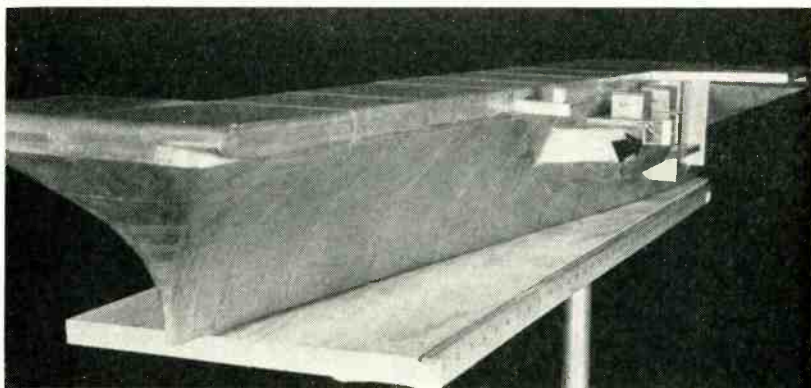

METAL scale model of aircraft carrier, constructed by Federal Telecommunication Laboratories, tests proposed antenna installations (one mounted on gun tub, arrow). Illuminated by microwave transmitter, the model is rotated to find how well the antenna picks up signals from different directions

U. S. S. Forrestal uses sound power and dial phones; speaking tubes are out

MODERN as any warship can be, the recently commissioned carrier Forrestal thinks, talks, listens and shouts with the latest electronic devices. Gone is the ancient and honorable speaking tube. Sound-powered and dial telephone circuits connect various centers together. A general announcing system, larger than any known commercial p-a, is driven by six 1,000-watt amplifiers.

► **Eyes and Ears**—To find where she is going and what lurks about, the Forrestal is equipped with air-search radar, loran, direction finders and underwater echo sounders.

To guide her planes home to the flight deck there are accurate 200-mile beams from Tacan equipment. Close in, GCA brings aircraft to touchdown in any kind of weather.

Balloon-borne sounding devices can be sent up to help track wind velocity and direction high above, besides reporting temperature and humidity. Fire-control radar protects the carrier from enemy action.

► **Communications** — Morse code, voice and teleprinter communications are available in quantity. Communications to aircraft using uhf has been made effective by four pairs of antennas (to insure 360-deg coverage) mounted below the flight deck.

Defense Department Wants More Reliability

Effort is made to set up basic policies and guides to improve miltronic equipment

IMPORTANCE of engineering for equipment reliability was emphasized by J. M. Bridges, Director of Electronics, Office of the Assistant Secretary of Defense, at a recent conference on reliability at Aberdeen Proving Ground, Md.

► **Plans**—The Office of Electronics, Assistant Secretary of Defense (Applications Engineering) is attempting to improve the reliability and producibility of military elec-

(Continued on page 26)

Performance



New
PRO-310

is TOPS!

The "Heart" of the PRO-310

Newly developed front-end with three tuned circuits but only one RF tube amplifier provides remarkable selectivity and ultra-high signal-to-noise-ratio.

When you buy communications receivers, you buy performance above all else. And, performance is what you get when you buy the NEW PRO-310. It's the receiver designed with performance in mind. And, the PRO-310 outperforms all other receivers in its class. Here's why—

Took 3 years engineering and design time to develop, including 1½ years to iron out the 'bugs'. Hammarlund has the receiver know-how gained by making thousands of sets for gov't service.

These features:

- Frequency readings to 1 part in 5000
- Continuous calibrated bandspread *over the entire range*
- Exceptional stability
- High Image Rejection — *on all 6 bands*
- Sectionalized construction
- Etched and plated circuits in the RF section
- Many others

Check on the NEW PRO-310—it's made to order for your "tough-spot" service. Write for specs and other details to The Hammarlund Manufacturing Co., Inc., 460 West 34th Street, New York 1, N. Y. Ask for Bulletin E-11.

 **HAMMARLUND**

Since 1910

tronic equipment and parts. A specific program, covering contractual methods, engineering policies, test procedures and design specifications underlying equipment reliability is now being formulated.

► **Reason**—The greatest cause of unreliability, according to Bridges, is the lack of maturity of product design, and failure to evaluate reliability of design through tests, service and material evaluation before production is undertaken.

Planning officers want early production of advanced new weapons, while research and development people seek to attain basic technological goals, often neglecting production engineering.

► **Circuit**—Circuit design must be accomplished so that tubes and components will work well within their ratings, and so that a change in operating characteristics will not cause failure. If this design philosophy is not reflected in breadboard circuitry, it is unlikely that it can be introduced as design progresses. Reliability of much existing equipment suffers from critical circuits which will work only with selected tubes or special parts.

Financial Roundup

Profit reports in fiscal 1955 continue to show up well for electronics firms

COMPANIES in the electronics field continued active on the financial front during the past month. Three companies announced securities transactions and the following firms reported net profits for the fiscal periods indicated:

Company	Net Profit	
	1955	1954
Am. Cable & Radio 6m	\$404,732	\$906,970
American Electronics 6m	144,161	138,325
ACF Industries 3m	2,062,132	1,557,541
Beckman Instruments 12m	1,322,050	920,280
Electronics Engineering 6m	33,464	27,142
Garrett Corp. 12m	3,732,035	2,847,907
IT&T 6m	11,411,701	10,112,810
Magnavox 12m	2,426,087	2,102,530
Olympic Radio 6m	158,722	76,993
Precision Radiation Inst. 9m	496,658	122,835
Pyramid Electric 6m	235,080	313,567
Raytheon 3m	764,000	1,102,000
Westinghouse Air Brake 6m	3,227,911	2,317,916

FUTURE MEETINGS

- Oct. 31-Nov. 1: 1955 East Coast Conference on Aeronautical and Navigational Electronics, IRE, Lord Baltimore Hotel, Baltimore, Md.
- Oct. 31-Nov. 1: International Conference on Scientific Basis of Applied Solar Energy, University of Arizona, Tucson.
- Nov. 1-5: World Symposium On Applied Solar Energy sponsored by AASE, Stanford Research Institute and University of Arizona, Phoenix, Ariz.
- Nov. 3-4: Eighth Annual Electronics Conference, Kansas City IRE, Town House, Kansas City, Kan.
- Nov. 3-4: Unclassified Symposium On The Technical And Operational Characteristics Of Tacan, Air Navigation Development Board, Hotel Statler, Washington, D. C.
- Nov. 7-9: IRE, AIEE, ACM Eastern Joint Computer Conference, Hotel Statler, Boston, Mass.
- Nov. 10-11: Electronic Business Systems Conference, National Machine Accountants Association, Statler Hotel, Los Angeles.
- Nov. 11: Centennial Symposium on Modern Engineering, University of Pennsylvania, Philadelphia, Pa.
- Nov. 14-15: IRE Symposium on Communication by Scatter Techniques, Lisner Hall of George Washington University, Washington, D. C.
- Nov. 14-16: IRE, AIEE, ISA Electrical Technology in Biology & Medicine, Shoreham Hotel, Washington, D. C.
- Nov. 15-17: Second International Automation Exposition, Navy Pier, Chicago, Ill.
- Nov. 21-22: IRE Aeronautical Communications Symposium, Hotel Utica, Utica, N. Y.
- Nov. 28-30: IRE Instrument Conference & Exhibit, Hotel Biltmore, Atlanta, Georgia.
- DEC. 12-16: Nuclear Engineering and Science Congress, coordinated by Engineers Joint Council, Cleveland, Ohio.
- DEC. 15-17: URSI Fall Meeting, University of Florida, Gainesville, Fla.
- JAN. 9-10, 1956: Second National Symposium On Reliability And Quality Control In Electronics, ASQC and RETMA, Hotel Statler Washington, D. C.
- FEB. 2-3, 1956: IRE National Symposium On Microwave Techniques, University of Pennsylvania, Philadelphia.
- FEB. 15-17: 1956 Conference On High-Speed Computers, Louisiana State University, Baton Rouge, La.
- FEB. 16-17 IRE, AIEE, Univ. of Pa. Conference On Transistor Circuits, University of Pennsylvania, Philadelphia, Pa.
- MAR. 19-22: IRE National Convention, Waldorf-Astoria Hotel, Kingsbridge Armory, New York, N. Y.
- APRIL 11-13: 1956 IRE 7th Region Technical Conference, Hotel Utah, Salt Lake City.
- APRIL 25-27: Symposium On Nonlinear Circuit Analysis, II, Polytechnic Institute of Brooklyn, New York, N. Y.

Industry Shorts

► **Production** of one million sq ft of printed wiring boards in 1956, representing between 5 and 6 million individual boards, is planned by GE.

► **Since 1947**, the electronics industry on the West Coast has produced one new company each week according to P.S. Fogg of Consolidated Engineering.

► **Definite** development program looking toward the substitution of

aluminum for copper in telephone cable, was announced by Western Electric.

► **Diffused base** transistors are being made at Motorola by impregnating pure germanium slices with arsenic or bismuth gas.

► **Air Force** ordered \$2.3 million worth of magnetrons from Westinghouse.

► **Transistor** firm in Germany, Intermetal G. m.b. H., has been acquired by Clevite Corp.

KAY

NOISE FIGURE MEASUREMENT 10 - 3000 MC

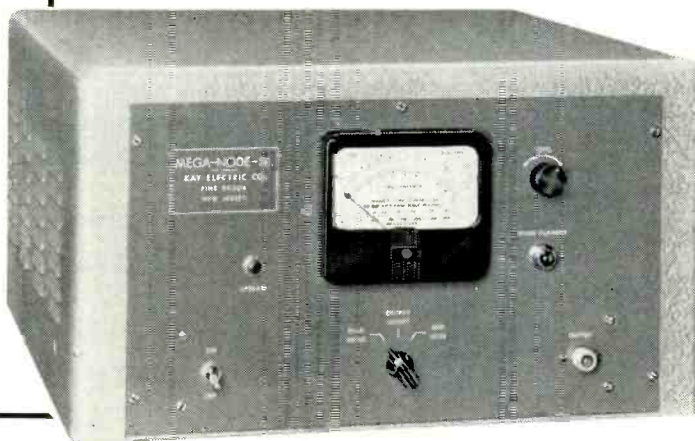

SPECIFICATIONS

- Frequency Range:**
10 mc to 3,000 mc
- Output Impedance:**
50 ohms unbalanced into Type N Connector
- Noise Figure Range:**
0 to 20 db
- Filament Voltage Supply:**
From regulated supply
- Meter Calibration:**
Linear in db noise figure; logarithmic in D.C.M.A.
- Fuse Protection:**
One Type 3AG, 2 amps
- Tubes:**
1 Eclipse Pioneer TTI Diode
- Power Supply Source:**
117 Watts $\pm 10\%$. 60 cps AC
Available for 50 cps.
- Power Consumption:**
130 Watts
- Price:**
\$995. FOB plant

KAY *Mega-Node-Sr.*

A calibrated random noise source providing an output from 10—3,000 mc, the Mega-Node Sr. may be used to measure noise figure and receiver gain and for the indirect calibration of standard signal sources.

At the lower end of the frequency range noise figure may be obtained directly from the meter. For greater accuracy at higher frequencies, corrections for diode transit time and termination mismatch are available from charts supplied with each instrument.

KAY *Rada-Node* ▶

Complete radar noise figure measuring set for IF and RF, including attenuators, detector and noise sources. Complete with power supplies. Frequency range: 5 to 26,500 mc; noise figure: range, up to 21 db, in lower part of spectrum. Prices on request.

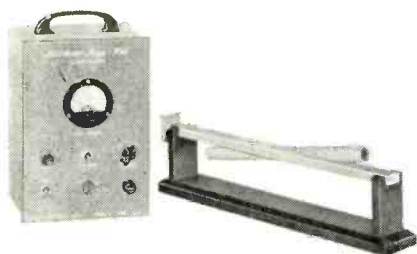

KAY *Microwave Mega-Nodes*

Calibrated random noise sources in the microwave range, used to measure noise figure, and receiver gain and calibrate standard signal sources in radar and other microwave systems.

Available in following waveguide sizes to cover range of 960—26,500 mc.

- RG-69/U .. \$400. Available with fluorescent or inert gas (argon or neon) tubes. Noise output fluorescent tubes, 15.8 db ± 2.5 db; argon gas tubes, 15.2 db ± 1 db*;
- †RG-48/U .. 195. neon tubes, 18.0 db ± 5 db*.
- †RG-49/U .. 195.
- †RG-50/U .. 195.
- †RG-51/U .. 195.
- †RG-52/U .. 195.
- RG-91/U .. 250. *Noise output of inert gas tubes independent of operating temperature.
- RG-53/U .. 250. Universal Power supply for both fluorescent or argon gas and all waveguide sizes: \$100.

†\$167. per Guide when 3 or more are purchased with \$100. Power Supply
NEW! WR-770; WR-650—\$595.00 each; WR-510; WR-430; WR-340—\$495.00 each. All WR numbers fluorescent only.

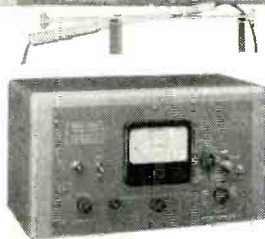
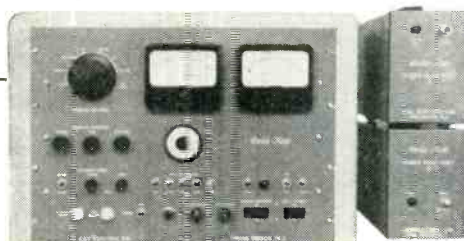

KAY *Mega-Node*

Calibrated random noise source reading direct in db, for measurement of noise figure, receiver gain and for indirect calibration of standard signal sources. Frequency range, 5 to 220 mc; Output impedances, unbalanced—50, 75, 150, 300, Infinity; balanced—100, 150, 300, 600, Infinity; noise figure range, 0—16 db at 50 ohms 0—23.8 db at 300 ohms. Price: \$295. FOB plant.

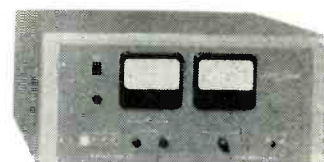

KAY *Auto-Node*

Designed for production-line noise figure measurement from 5 to 26,500 mc., the Auto-Node provides continuous interpolation over VHF, UHF and microwave frequencies. Two models are available:

MODEL TV	MODEL RADAR
Freq. Range: 5—220 mc.	Freq. Range: 2 IF Strips 30 and 60 mc; other
IF Strips: 20 or 40 mc. extra IF Strips available.	IF's available.
Noise Figure Range: 0—24 db	IF Noise Figure: 0—7 db
Price: \$795 FOB plant. Additional IF Strips, \$125.00	Price: \$950. with 2 IF strips. FOB plant

For Complete Information Regarding these, and other Kay Instruments, Write:

KAY ELECTRIC COMPANY

Dept. E-11, 14 Maple Avenue

Pine Brook, N. J.

NOW! ALL-ANGL Barry Mounts *IN ALL JAN SIZES* for Jet and Missile Service

ALL-ANGL MINIATURE ISOLATOR

The new Barry ALL-ANGL mounts are built to handle the new jobs — too tough for MIL-standard mounts — the complete ALL-ANGL line lets you choose the JAN size best suited to your needs — for sure protection against shock and high-frequency vibration in all directions.

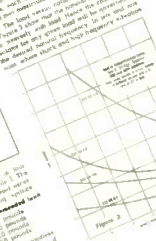
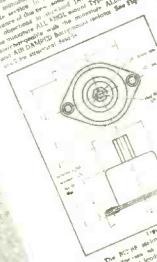
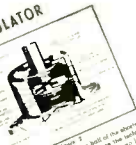

Built to handle the new jobs — too tough for MIL-standard mounts — the complete ALL-ANGL line lets you choose the JAN size best suited to your needs — for sure protection against shock and high-frequency vibration in all directions.

Complete information about ALL-ANGL Barry Mounts is given in our free engineering data sheets. You'll find load-deflection curves, transmissibility curves, load-versus-natural-frequency curves, and tables of load ranges — for practical solutions to the shock and vibration problems you meet in designing for jets and missiles.

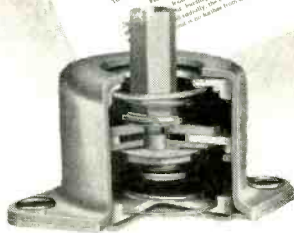

Now Available — Miniature ALL-ANGL mounts, JAN-size 0, for loads up to 3 pounds per isolator. Data Sheet #455 gives dimensions and performance curves that show how you can use these Barry Mounts.



Ready December 1, 1955 — JAN-size 1 ALL-ANGL mounts for loads from 1 to 10 pounds per isolator. Data Sheet #1255 giving details of load ratings, dimensions, and performance curves also available December 1.



Ready February 1, 1956 — JAN-size 2 ALL-ANGL mounts for loads from 2½ to 40 pounds per isolator. Data Sheet #256 will be available Feb. 1 with load, dimension, and performance data.

Write us today — we'll send the first data sheet at once and the others as soon as they are printed. And if you have an immediate problem, our engineers are ready to answer your questions from their experience gained in years of pioneering the development of shock and vibration isolators for military, naval, aircraft, missile, and industrial uses.

New engineering opportunities are open in Barry's expansion program, at all levels in all departments. Send resumé.

When your problem is protection thru all flight attitudes, your answer is the ALL-ANGL. For recommendations, call your Barry Sales Representative.

BARRY CONTROLS incorporated 707 Pleasant St. Watertown 72, Mass.

AT MACH 1+



JACK & HEINTZ
MODEL 50127-000
CONTROL PANEL

PHOTOS COURTESY OF
CONVAIR AND JACK & HEINTZ.

ALL-ANGL Barry Mounts give sure protection

Jack & Heintz proved this in testing mounts to protect their Hi-Phase voltage regulators and control panels for Convair's supersonic F-102A interceptor.

No other miniature isolator tested could meet Procedure I of MIL-E-5272A. ALL-ANGL Barry mounts exceeded life-test requirements.

And the ALL-ANGL works in any position—to give sure protection for vital controls through every twist, turn, and dive in the aircraft's most violent maneuvers.

Write for Data Sheet J-11. And for your airborne requirements to meet standard MIL specifications, ask about All-Metl, Air-damped, and special Barry mounts.

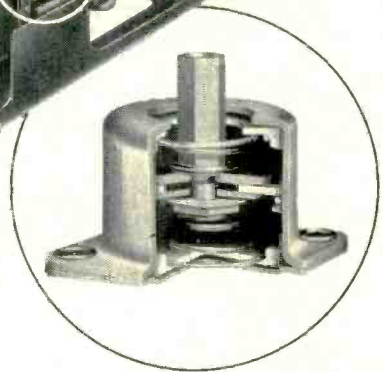

Here's the mount that meets the new needs of today's jet aircraft and missiles—where equipment must have greater protection against shock and high-frequency vibrations—and where MIL-standard mounts prove inadequate.

BARRY CONTROLS incorporated 707 Pleasant St. Watertown 72, Mass.

New engineering opportunities are open in Barry's expansion program, at all levels in all departments. Send resumé.

Now! Take your



Famous acetate-backed "Extra Play" Tape 190—new economy price saves you 28%

Here's your chance to buy the magnetic tape everyone's talking about—at a special *new economy price!* It's popular "SCOTCH" Brand "Extra Play" Magnetic Tape 190, first long play tape on the market and *still* the best seller. With 50% more recording time on every reel . . . higher fidelity . . . strength to spare . . . high potency oxide . . . "SCOTCH" "Extra Play" Magnetic Tape 190 has been making recording history. Buy now and save 28% on every reel!

Both these **SCOTCH** Magnetic Tapes
REG. U.S. PAT. OFF.
BRAND

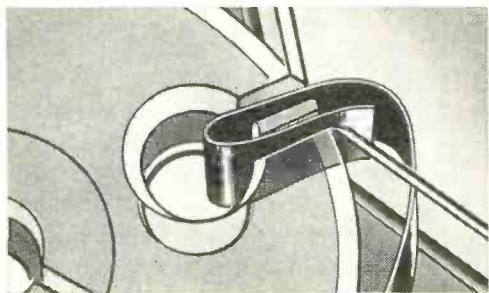

EASIER THREADING with new "Loop-Lok" reel! Saves time . . . saves tape! It's "SCOTCH" Brand's exclusive "Loop-Lok" reel. Just loop tape around the new-design center pin for instant threading. Tape locks tight without necessity of troublesome wrap-around, yet releases fast at end of reel.

The term "SCOTCH" and the plaid design are registered trademarks for Magnetic Tape made in U.S.A. by MINNESOTA MINING AND MFG. Co., St. Paul 6, Minn. Export Sales Office: 99 Park Avenue, New York 16, N.Y. © 1955 3M Co.



choice of backings

New polyester-backed (Made from DuPont's "Mylar"*) "Extra Play" Tape 150 for extra strength

Years ago "SCOTCH" Brand pioneered tough polyester-backed magnetic tape for experimental government orders. Now you can enjoy the same benefits of "SCOTCH" Brand research and development with new "Extra Play" Magnetic Tape 150. "SCOTCH" Brand's extra-strength polyester backing assures you long-lasting recordings . . . perfect tape performance in all weather, all climates—(It's "Weather-Balanced"!)



feature "Loop-Lok" reel and high-potency oxide!

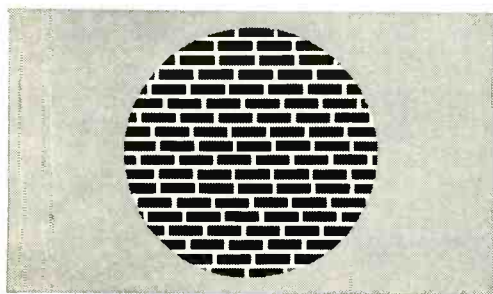

CRISP, BRILLIANT SOUND thanks to newest oxide coating! By laying fine-grain oxide particles in a neat, orderly pattern (as shown here), "SCOTCH" Brand is able to pack in thousands more particles than standard long play tapes — to produce a super-sensitive magnetic recording surface.

**"Mylar" is a registered Du Pont trade-mark.

REG. U.S. PAT. OFF.
SCOTCH
BRAND

Extra Play Magnetic Tapes



BH "1151"

**CLASS H
ELECTRICAL SLEEVING
THAT
LAUGHS AT BENDS**

Torture-test some sample lengths of BH "1151" Silicone Rubber Fiberglas Sleeveings for electrical insulation. Put them through a variety of bends and twists. Use them to cover bumps, terminals and soldered joints. Then check the insulating protection and absence of fray of BH "1151" even under that kind of use and abuse. Prove to yourself its ability to give complete protection to your product, even under the most strenuous conditions.

Color, without sacrifice of strength — for circuit tracing and coding — is no problem when you standardize on BH "1151" Sleeveings. They're available in 8 basic colors. Tracer stripes to extend color code possibilities are available on special order.

BH "1151" is resistant to the high spot temperatures encountered in soldering. It will sustain 15 consecutive minutes at 600° F. without loss of flexibility or strength. And it remains unchanged after *continuous* operation from -90° F. to 400° F.

The properties of this outstanding product are covered by MIL-I-18057.

Spool or coil put-up, now widely preferred, is made possible by the BH patented manufacturing method. BH "1151" is also available in 36" lengths, or short pieces on special order. Made in sizes to fit Awg or B&S bare wires from 24 to 3/8" inclusive. Write for data sheets and free Production Testing Samples today.

BENTLEY, HARRIS MANUFACTURING CO. 1311 BARCLAY ST.
CONSHOHOCKEN, PA. TELEPHONE: CONSHOHOCKEN 6-0634

BENTLEY, HARRIS

*Fiberglas**
SLEEVINGS

*BH Non-Fraying Fiberglas Sleeveings are made by an exclusive Bentley, Harris process (U.S. Pat. Nos. 2393530; 2647296 and 2647288). "Fiberglas" is Reg. TM of Owens-Corning Fiberglas Corp.

OHMITE[®]

AMRECON[®]

Relays

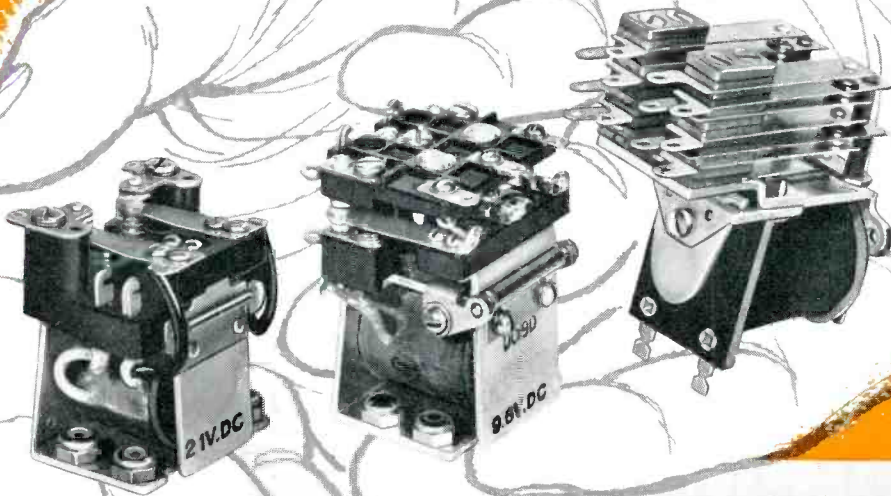

**HIGH QUALITY, ALL-PURPOSE RELAYS...
RUGGED, DEPENDABLE FOR LONG LIFE!**

61 types in three stock models

Ohmite Amrecon relays have proven their exceptional ruggedness and long life in years of service.

Now, three popular stock models—DOS, DO, and CRU, in 61 different types—are available from stock.

Models DO and DOS fill many industrial needs for a compact, lightweight relay that handles power loads usually requiring much larger, heavier units. They are particularly adaptable to aircraft and mobile equipment where severe shock and vibration are encountered. At 115 V_{AC} or 32 V_{DC}, noninductive load, Model DOS has a contact rating of 15 amp; Model DO, 10 amp; and Model CRU, 5 amp. Available in a wide range of coil operating voltages and contact combinations.

Current ratings up to 25 amp, AC or DC
Also made-to-order models in many contact combinations and coil voltages.



**HERMETICALLY SEALED OR
DUST-PROTECTIVE ENCLOSURES**



SEND FOR CATALOG R-10

Be Right with

OHMITE[®]

RHEOSTATS • RESISTORS • RELAYS • TAP SWITCHES

OHMITE MANUFACTURING COMPANY

3610 Howard Street, Skokie, Illinois
(Suburb of Chicago)

OHMITE® RHEOSTATS

HAVE Smoother Windings!

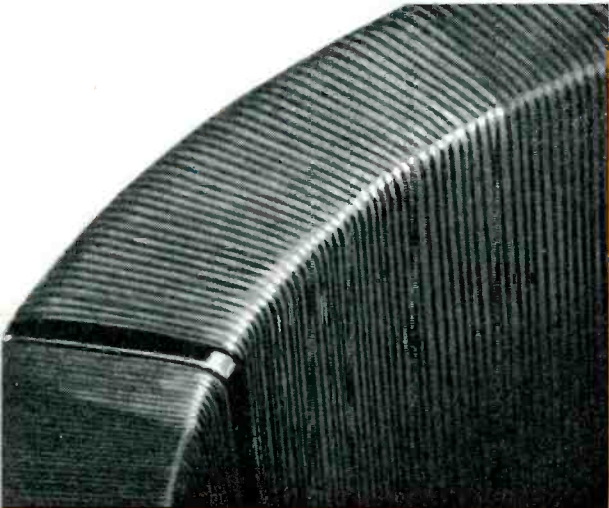

5 REASONS WHY—

- 1. PRECISION GROUND CORE** . . . Cores for fine wire, high resistance units are ground to give a smooth, flat contour for the contact brush.
- 2. SMOOTH JUNCTIONS** where wire sizes change between sections of tapered windings . . . less differential between wire sizes.
- 3. PERMANENTLY LOCKED WINDINGS** . . . Core and windings are bonded together with vitreous enamel to prevent shifting of wire.
- 4. UNIFORM WIRE SPACING** . . . Ohmite has developed special winding machines to insure uniform spacing and eliminate crossover of adjacent turns on fine wire units.
- 5. FLUSH TERMINALS** . . . Terminals are flush with windings . . . brush glides smoothly from windings to terminal.

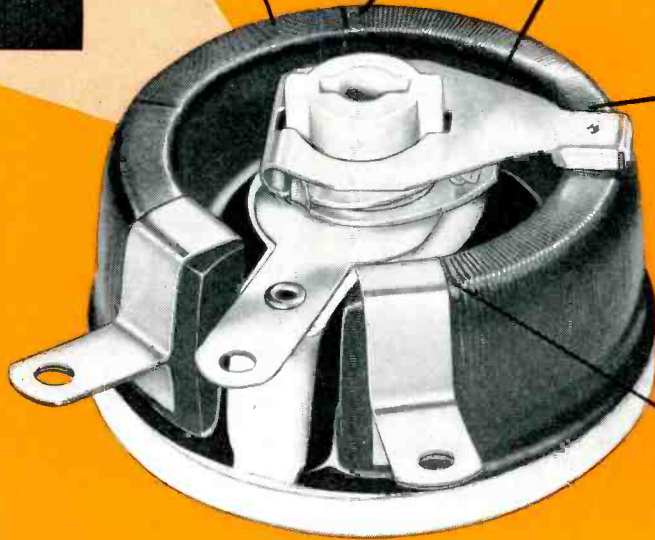

See for yourself! Examine an Ohmite Rheostat first hand. Compare its smoother resistance windings. Turn the knob and note how easily and smoothly the contact brush glides over the rheostat windings.

There's less wear on the resistance wire and on the contact brush. The brush makes contact with all of the turns and the resistance varies smoothly and uniformly as the shaft is turned. Every Ohmite Rheostat is *individually tested* on ultrasensitive electronic instruments to assure perfect contact between the winding and the contact brush.

Standardize on Ohmite Rheostats for unsurpassed dependability, smoothness of operation, and long life.

A COMPLETE LINE OF RHEOSTATS

from 25 to 1000 watts. Also available to meet MIL-R-22A requirements in each of the 26 type designations.

Write on company letterhead for Catalog and Engineering Manual No. 40.

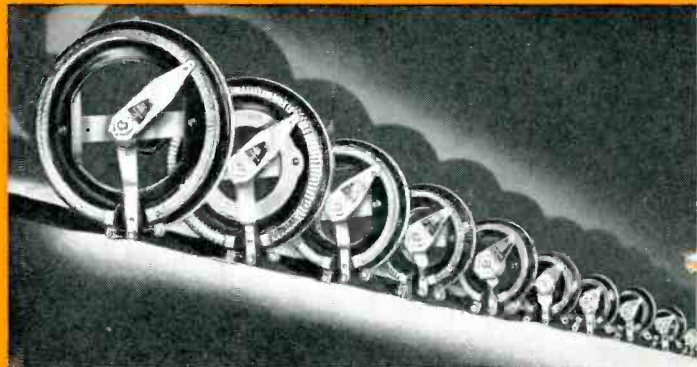

Be Right with **OHMITE®**

OHMITE MANUFACTURING COMPANY, 3610 Howard Street, Skokie, Illinois (Suburb of Chicago)

RHEOSTATS • RESISTORS • RELAYS • TAP SWITCHES

EIMAC klystrons are used in first established UHF forward-scatter communication system

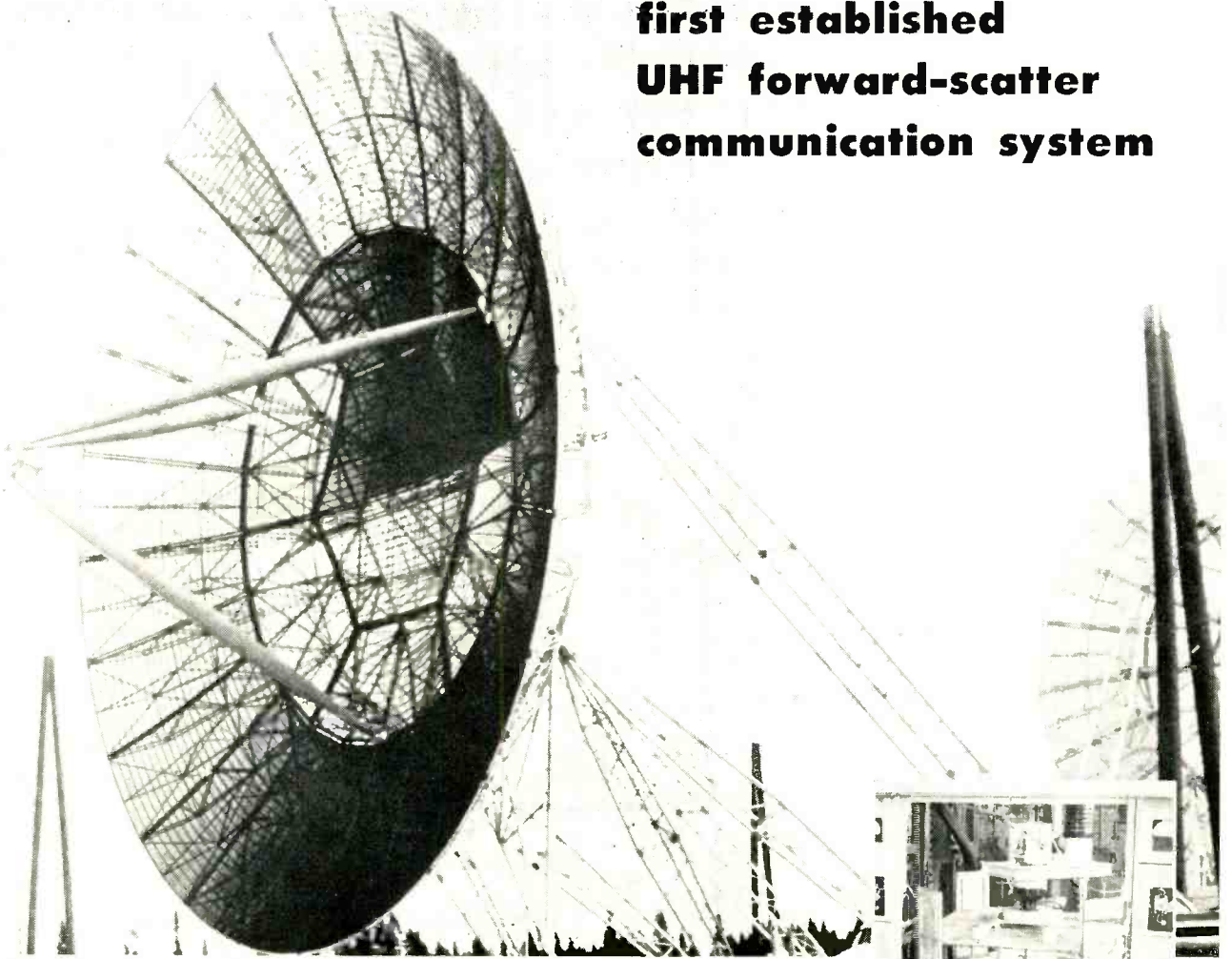

A link in the northern communication system (photo courtesy of Bell Telephone Company of Canada).

In the forward-scatter communication system installed by the Bell Telephone Company of Canada over the rugged terrain of the north, Eimac amplifier klystrons are used exclusively. Eimac amplifier klystrons generate the high power necessary for revolutionary beyond-the-horizon scatter techniques. Their reliability and performance assure outstanding operation and minimize maintenance problems. Their simple, straightforward design, plus high power gain, make transmitter construction easy. All these features contributed to the selection of Eimac klystrons for the vital communication systems of the north. Now in operation for thousands of hours in these communication systems, Eimac klystrons have justified the early faith put in them and have aided substantially in making UHF forward-scatter a reliable method of distant communication.

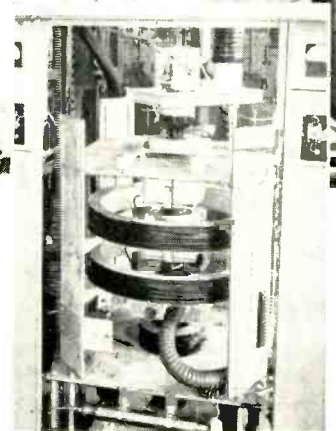

Eimac high power klystron and Eimac-developed circuit components in final amplifier stage of forward-scatter transmitter (photo courtesy of Radio Engineering Laboratories).



EITEL-McCULLOUGH, INC.
SAN BRUNO, CALIFORNIA
The World's Largest Manufacturer of Transmitting Tubes



DIRECT READING

SPECTRUM ANALYZER

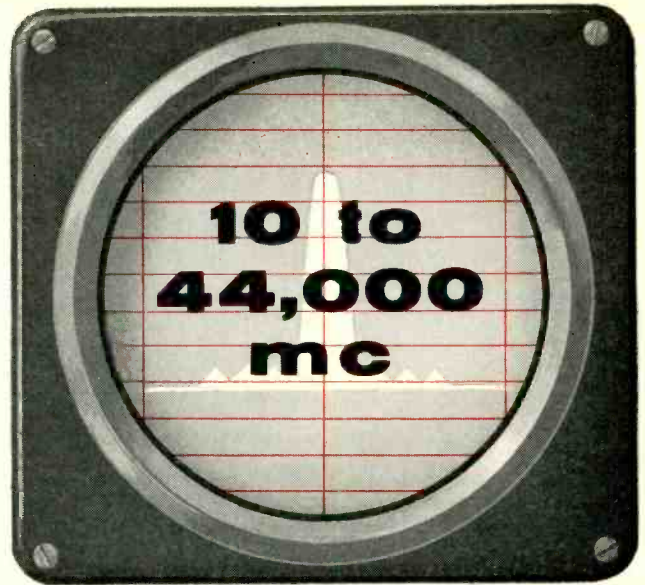

Years of day-in, day-out field operation by most exacting users, have proven the Polarad Model TSA Spectrum Analyzer to be a versatile test instrument of highest reliability and accuracy for both laboratory and production applications.

It is a broadband instrument with greatest pulse sensitivity over the band—10 to 44,000 mc. And each of its five interchangeable RF tuning heads operate with utmost simplicity and frequency stability. All tuning is by Uni-Dial control. Frequencies are read with 1% accuracy right on the linear dial as the set is tuned. No mode charts or interpolations necessary.

The Polarad Model TSA has been designed to save engineering manhours. Its 5 inch CRT display of the RF spectrum is bright and easily defined. And its 1 cycle sweep speed makes for fine resolution. For detailed specifications, contact your nearest Polarad Representative, or write directly to the factory.

APPLICATIONS

- Transmitter characteristics tests
- Broadband receiver for AM, FM, CW, MCW, and pulse modulated signals
- Component tests
- Frequency measurements
- Leakage, interference and radiation measurements
- Bandwidth measurements
- Modulation tests
- Adjacent signal channel tests
- Attenuation measurements
- Filter measurements
- Standing wave measurements

MULTI-PULSE SPECTRUM SELECTOR



MODEL SD-1

Increases the versatility of Polarad Spectrum Analyzers. It displays and allows selection for analysis of a specific train of microwave pulses, as well as any one pulse in the train; selects and gates a group of pulses up to 180 μ sec. in length; and is designed to work with fast, narrow pulses; can be adjusted to gate any pulse including the first at zero time. Special circuitry discriminates automatically once pulses have been selected. Operates at any of the frequencies accepted by Polarad Spectrum Analyzers.

FEATURES:

Continuously variable sweep widths; 15 to 180 μ sec. • Continuously variable gate widths for pulse selection; 0.4 to 10 μ sec. • Continuously variable gate delays for pulse selection; 3 to 180 μ sec. • Automatic gating of spectrum analyzer during time of pulse consideration. • Intensified gate (brightening) to facilitate manual pulse selection. • Triggered sweep on first pulse in any train. • No sweep in absence of signal.

SPECIFICATIONS:

Maximum Pulse Train Time 180 μ sec. • Pulse Rise Time .05 μ sec. Minimum • Minimum Pulse Separation .2 μ sec. • Repetition Rate 10–10,000 pps. • Minimum Pulse Width .1 μ sec. • Input Power 95 to 130 volts, 50/60 cps., 325 watts. • Input Impedance 50 ohms. • Output Impedance 50 ohms (to match TSA Spectrum Analyzer).

BROADBAND SPECTRUM ANALYZER

FEATURES

- Greatest signal sensitivity over entire frequency band.
- Single frequency control with direct-reading dial accurate to $\pm 1\%$.
- Complete frequency coverage from 10 mc to 44,000 mc.
- Internal RF attenuator (RF Tuning Unit Models STU-1, STU-2A, STU-3A).
- Adjustable frequency display from 400 kc to 25 mc.
- Frequency differences as small as 40 kc measurable by means of adjustable frequency marker with variable amplitude.
- 25-kc resolution for all bands.
- Stable klystron oscillators using non-contacting plungers to insure longer life.
- No klystron modes to set.
- 5-inch CRT display.
- Portable and completely self-contained.



MODEL
TSA

SPECIFICATIONS

Model No.	Equipment
Model Du.....	Spectrum Display and Power Unit
Model STU-1...	RF Tuning Unit 10-1,000 mc.
Model STU-2A.	RF Tuning Unit 910-4, 560 mc.
Model STU-3A.	RF Tuning Unit 4,370-22,000 mc.
Model STU-4	RF Tuning Unit 21,000-33,000 mc.
Model STU-5...	RF Tuning Unit 33,000-44,000 mc.

SPECIFICATIONS:

Frequency Range: 10 mc to 44,000 mc.

Frequency Accuracy: $\pm 1\%$

Resolution: 25 kc.

Frequency Dispersion: Electronically controlled, continually adjustable from 400 kc to 25 mc per one screen diameter (horizontal expansion to 20 kc per inch)

Input Impedance: 50 ohms—nominal

Sensitivity:*

STU-1 10-400 mcs—89 dbm
400-1000 mcs—84dbm

STU-2A 910-2,200 mcs—87 dbm
1,980-4,560 mcs—77 dbm

STU-3A 4,370-10,920 mcs—75 dbm
8,900-22,000 mcs—60 dbm

STU-4 21,000-33,000 mcs—55 dbm

STU-5 33,000-44,000 mcs—45 dbm

Overall Gain: 120 db

Attenuation:

**RF Internal 100 db continuously variable,

IF 60 db continuously variable

Input Power: 400 Watts

*Minimum Discernible Signal

**STU-1, STU-2A, STU-3A



Write for your copy of the Polara "Handbook of Spectrum Analyzer Techniques". 50c per copy. Includes discussion of Spectrum Analyzer operation, applications and formulae for analysis techniques.

AVAILABLE ON EQUIPMENT LEASE PLAN

FIELD MAINTENANCE SERVICE AVAILABLE THROUGHOUT THE COUNTRY

Consult us on your Spectrum Analysis Problems



ELECTRONICS CORPORATION 43-20 34th STREET, LONG ISLAND CITY 1, N. Y.

REPRESENTATIVES • Albuquerque • Atlanta • Baltimore • Boston • Buffalo • Chicago • Dayton • Englewood • Fort Worth • Los Angeles • New York
Philadelphia • San Francisco • Syracuse • Washington, D. C. • Westbury • Winston-Salem • Canada, Arnprior, Toronto—Export: Rocke International Corporation

MIDWESTERN'S proven Servovalves can solve your problems

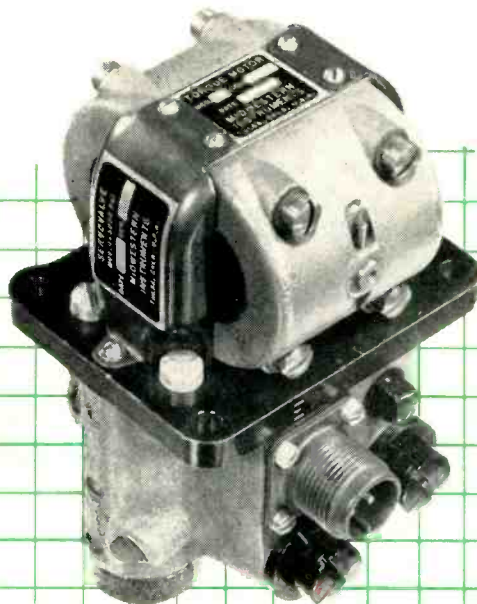

for Automation and Control

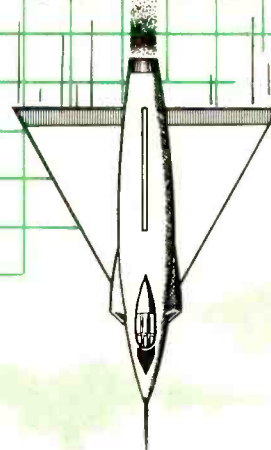
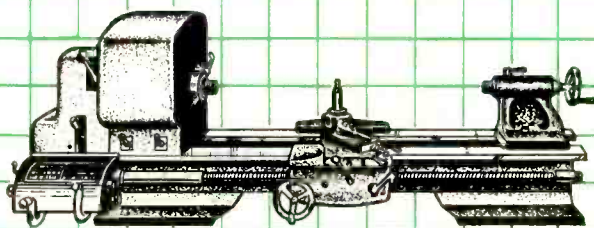

products

- OSCILLOGRAPHS
(LABORATORY AND FLIGHT TEST)
- MAGNETIC STRUCTURES
- GALVANOMETERS
- AMPLIFIERS
- HYDRAULIC SERVOVALVES
- TORQUE MOTORS
- SERVOAMPLIFIERS
- DATA REPEATERS
- WATERPROOF CONNECTORS
- GEOPHYSICAL EQUIPMENT

For servovalves—components, or complete systems for control or automation in ANY industry . . . Midwestern production facilities can help you solve your problems.

*Write for Assistance with your Automation
or Control problems*



MIDWESTERN INSTRUMENTS

41st and Sheridan Road

Tulsa, Oklahoma

Send for this *Free* **SAMPLE FOLDER...**

Contains
25
 different Test Samples of
 high-dielectric
INSULATING
TUBING and SLEEVING

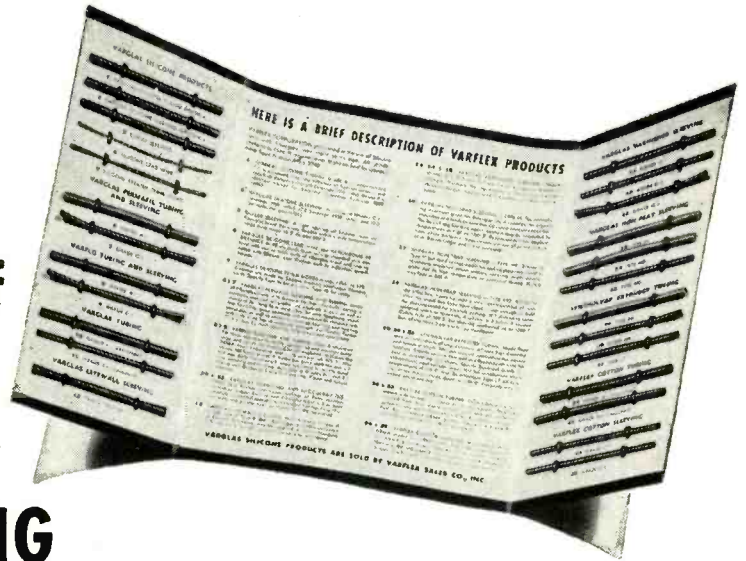

INCLUDES SAMPLES AND DESCRIPTIONS OF THE FOLLOWING...

VARGLAS SILICONE Class H insulating materials were pioneered by our Laboratory. Retain flexibility, electrical properties and mechanical strength in temperatures ranging from -85°F. to 500°F. Available in tubing, sleeving, lead wire, tying cord.

PERMAFIL-IMPREGNATED VARGLAS TUBING Fiberglas braid coated with General Electric's Permafil resin. Extremely tough, resistant to solvents and elevated temperatures, highly flexible. Can be bent or twisted with little or no loss of dielectric strength. Coils and standard 36" lengths.

VARGLAS SLEEVING AND TUBING Numerous types and grades—including synthetic-treated, varnished, lacquered, saturated, litewall and others.

VARGLAS NON-FRAY SLEEVING Fiberglas braid normalized to remove all organic impurities. It will withstand temperatures up to 1200°F. Recommended where dielectric properties are not paramount. Three types available.

VARFLO TUBING AND SLEEVING Vinyl-coated Fiberglas in full range of sizes, colors and grades. Extremely flexible with excellent heat aging qualities. Low priced.

VARFLEX COTTON TUBING AND SLEEVING Varnish or lacquer impregnated—for applications where MIL-I-3190 Class A materials are specified. All NEMA grades.

SYNTHOLVAR EXTRUDED TUBING Made in various standard formulations of vinyl polymers. Has high dielectric and tensile strength—will not support combustion nor absorb moisture. Type EG Approved under MIL-I-631A. Several others to meet special requirements.

NEW! VARGLAS SILICONE RUBBER SLEEVING AND TUBING—the culmination of 5 years of research—for applications requiring extraordinary flexibility. Details on request.



MAIL COUPON TODAY FOR SAMPLES!

VARFLEX CORPORATION,
 506 W. Court St., Rome, N. Y.

Please send me free folder containing samples of your electrical sleeving and tubing.

I am particularly interested in insulation for:

NAME

COMPANY

STREET

CITY ZONE STATE

NOW...the All-purpose 'Scope by WESTON

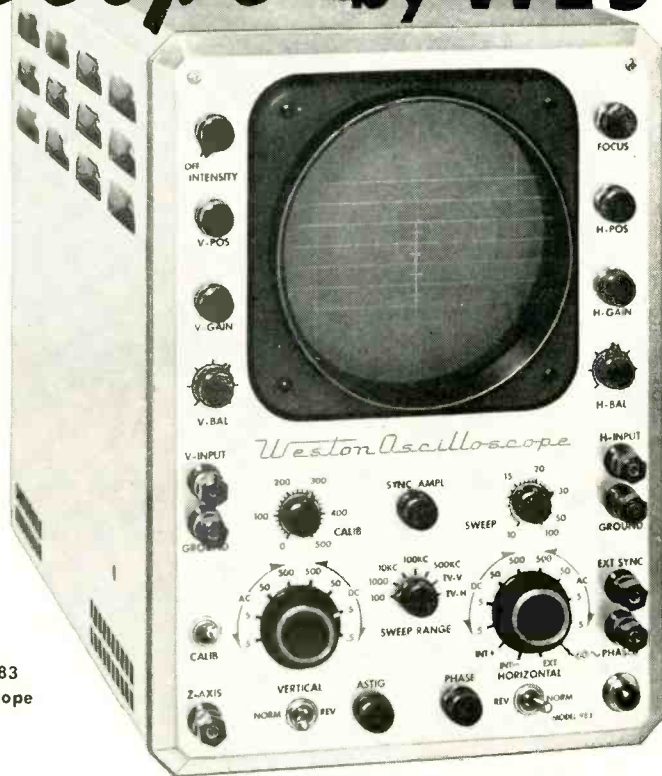

Weston
Model 983
Oscilloscope

Model 983 is a high gain, wideband Oscilloscope designed to accurately reproduce waveforms comprising a wide band of frequencies. High sensitivity of 15 millivolts per inch RMS makes this "scope ideal for—SETTING RESONANT TRAPS...SIGNAL TRACING IN LOW LEVEL STAGES...AS A GENERAL NULL INDICATOR...for PHASE CHARACTERISTIC MEASUREMENT IN INDUSTRIAL APPLICATIONS...and for SWEEP FREQUENCY VISUAL ANALYSIS.

The 'scope contains identical vertical and horizontal push-pull amplifiers with a choice of AC or DC coupling without affecting either sensitivity or band width. Both amplifiers have compensated step attenuators and cathode follower input. *It has excellent square wave reproduction with overshoot of only 2 to 5%, with a rise time of 0.1 microsecond. The 'scope response is essentially flat throughout the specified range of 4.5 mc and is usable to 6 mc.*

The unit has provisions for internal calibration, internal phased sine wave, and Z-axis intensity modulation. Reversal of polarity of both horizontal and vertical signals is easily accomplished by means of toggle switching. *Tube replacements are non critical, and etched circuitry facilitates quick and rapid maintenance.*

The Model 983 Oscilloscope is now available through local distributors. For complete literature write WESTON Electrical Instrument Corporation, 614 Frelinghuysen Avenue, Newark 5, New Jersey.

WESTON Instruments

WAVEFORM ANALYSIS

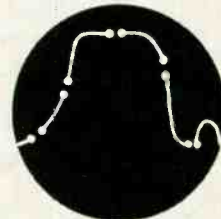

Response curves accurately displayed. Ideal for use with Weston intensity marker display. A fast, retrace sweep circuit with cathode follower output prevents pattern distortion.

SQUARE WAVE RESPONSE

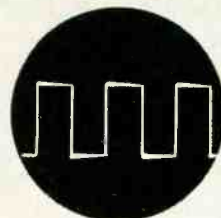

Overshoot is only 2 to 5%. Rise Time is 0.1 Microsecond. Square wave depicted 250 kc.

PHASE MEASUREMENTS

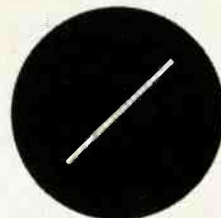

Phase shift between horizontal-vertical amplifiers, 0-500 kc-0°, to 1 mc within 2°; by internal adjustment with gain controls at max 0° phase shift possible on any specific frequency to 6 mc.

RESPONSE CHARACTERISTIC

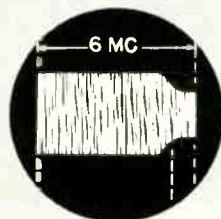

Note flatness throughout specified range; to 3.6 mc down 1.5 db, at 4.5 mc down 3 db, at 6 mc down 6 db.

For the most dependable printed circuits, you need the high bond strength, workability, heat-resistance of **C-D-F DILECTO[®] METAL-CLAD LAMINATES**

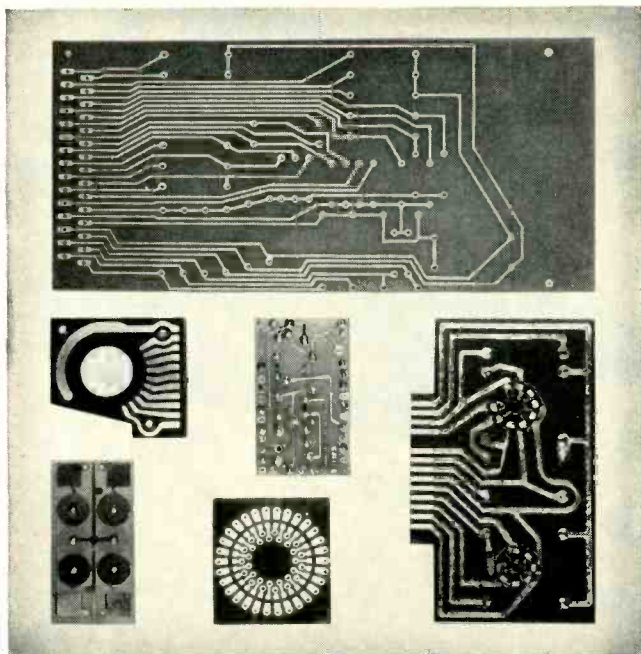

Printed circuits based on C-D-F materials are being used with great success in military electronic equipment, commercial television and radio sets, telephone switchboards—even sub-miniature radiosonde equipment and hearing aids. Photos courtesy of Photocircuits, Inc., Glen Cove, N. Y.

HIGH BOND STRENGTH—C-D-F's special adhesive for metal-clad Dilecto bonds the copper foil to the plastic without affecting the laminate's superior electrical properties. Heat-resistance, dissipation factor, dielectric constant, dielectric strength, and insulation resistance of the Dilecto base remain unaffected. The closely-bonded foil can be etched cleanly and dipped in hot solder to 220°C. (428°F.) for ten seconds with a guarantee of no blistering or separating. Metal-Clad Dilecto can be punched or machined either before or after etching.

EXCELLENT WORKABILITY—On all five Dilecto metal-clad grades, you can solder, punch, saw, and assemble components either by hand or automatically. Thanks to the inherently superior workability of the plastics laminate over that of ceramic-type materials, Dilecto can be dropped, jammed into tight chassis, and otherwise treated roughly on the assembly line and in service.

HIGH HEAT-RESISTANCE—Metal-Clad Dilecto Laminates are made of phenolic, epoxy, or Teflon* resin for various conditions of service and assembly, and have either cellulosic paper or woven glass-fabric base. All are ideally suited to printed-circuit applications in which heat-dissipation is a major problem. Continuous exposure to high ambient operating temperatures in enclosed electronic equipment has no significant effects on Dilecto's electrical and physical properties.

UNLOAD YOUR HEADACHE HERE! C-D-F, a big, reliable source of supply, can help you get the most for your printed-circuit money by reducing rejects, lowering fabrication costs, assuring dependable quality every time. Send us your print or problem, and we'll gladly supply appropriate test samples free. See our catalog in the Product Design File (Sweet's) or send for the new 20-page Dilecto catalog. Let your nearby C-D-F sales engineer (listed in Sweet's) help you right from the design stage!

TYPICAL PROPERTY VALUES					
	Copper-Clad PHENOLIC (Grade XXXP-26)	Copper-Clad PHENOLIC (Grade XXXP-24)	Copper-Clad EPOXY (Grade GB-116E)	Copper-Clad EPOXY (Grade GB-181E)	Copper-Clad TEFLON* (Grade GB-116T)
BOND STRENGTH—0.0014" foil (Lbs. reqd. to separate 1" width of foil from laminate)	5 to 8	5 to 8	8 to 12	8 to 12	5 to 8
MAXIMUM CONTINUOUS OPERATING TEMP. (Deg. C.)	120	120	150	150	200
DIELECTRIC STRENGTH (Maximum voltage per mil.)	800	800	700	650	700
INSULATION RESISTANCE (Megohms) 96 hrs. at 35°C. & 90% RH	50,000	50,000	30,000	20,000	Over 10 ⁶ megohms
DIELECTRIC CONSTANT 10 ⁶ Cycles	4.20	4.20	4.90	4.95	2.85
DISSIPATION FACTOR 10 ⁶ Cycles	0.026	0.026	0.019	0.018	0.0006
ARC-RESISTANCE (Seconds)	10	10	60	80	180
TENSILE STRENGTH (psi.)	16,000 x 13,000	14,000 x 11,000	46,000 x 42,000	48,000 x 44,000	23,000 x 21,000
FLEXURAL STRENGTH (psi.)	21,000 x 18,000	19,000 x 16,000	60,000 x 55,000	75,000 x 65,000	13,000 x 11,000
IZOD IMPACT STRENGTH edgewise (ft. lbs. per inch of notch)	0.40 x 0.35	0.40 x 0.35	6.5 x 6.0	13.5 x 11.5	6.0 x 5.0
COMPRESSIVE STRENGTH flatwise (psi.)	28,000	27,000	60,000	62,000	20,000
BASE MATERIAL OF LAMINATE	Cotton rag paper	Cotton rag paper	Fine-weave, medium-weight glass cloth	Medium-weave, medium-weight glass cloth	Fine-weave, medium-weight glass cloth
COLOR OF UNCLAD LAMINATE	Natural greenish	Natural Brown	Natural	Natural	Natural

All these standard grades are available with 0.0014", 0.0028", 0.0042", or thicker electrolytic or rolled copper foil on one or both surfaces. Other metal foils and other resin-and-base combinations can be supplied on special order.

*DuPont Trademark



NEWARK 16, DELAWARE

NEW ATOMIC CANNON

keeps its
own
score
on

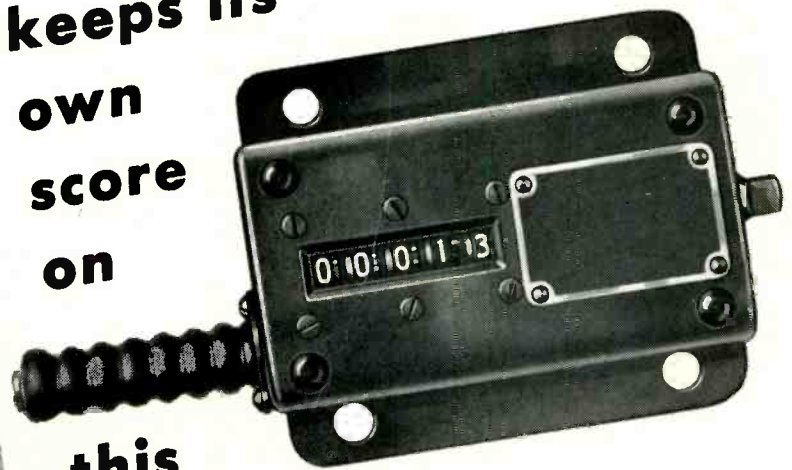

this
Veeder-Root
Counter

(U.S. ARMY PHOTO)



Added Evidence
that—

Everyone Can Count on **VEEDER-ROOT**

This mobile 280 mm. atomic cannon has *two* recoil motions. The primary recoil absorbs the cannon's "kick". The secondary recoil (something new in artillery) absorbs the forces created by the primary recoil. And each recoil motion is recorded by this special Veeder-Root Counter designed with a plunger-action shaft . . . which keeps the score on the cannon's use and indicates

approaching need for maintenance.

This again points up the fact that "Anything Worth Making — or Worth Doing — *Is Worth Counting.*" And Veeder-Root has the experience and resources *you* can count on, to give you any counter you need . . . for any mechanical or electrical application . . . in any field from Atomics to Automation. Write:

VEEDER-ROOT INCORPORATED
HARTFORD 2, CONNECTICUT



Chicago 6, Ill. • New York 19, N. Y. • Greenville, S. C.
Montreal 2, Canada • Dundee, Scotland
Offices and Agents in Principal Cities

"The Name that Counts"

NEW

from face to terminal block

Cramer

type 412 TIME DELAY RELAY

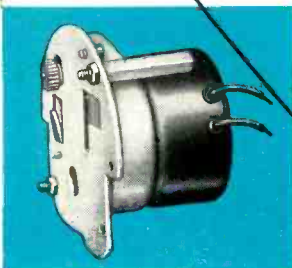
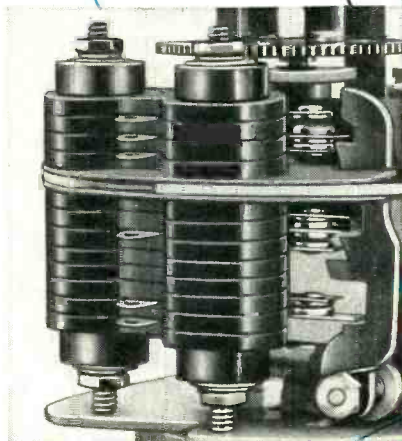
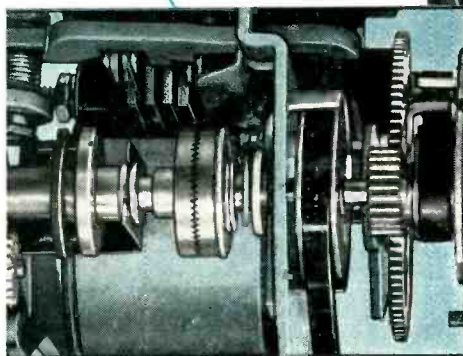

NEW—Repeat Accuracy within $\pm \frac{1}{4}$ of 1% of full scale (30 sec. and longer ranges); $\pm \frac{1}{2}$ of 1% on faster timers.

NEW—Full Vision Dial. 300 degree scale assures precise settings and fast, accurate readings. Dial and pointers protected by transparent cover.

NEW Contacts, rated 15 amps., give positive quick-make, quick-break operation. Contacts are of silver cadmium oxide with ability to handle high inrush currents.

NEW Flexibility in wiring. Nine-position terminal block offers side or rear connection, presents a variety of wiring possibilities.

NEW Reset Shock Spring Design laboratory tested for more than a million operations.

NEW Friction Setting Mechanism allows adjustment even while timer is operating.

NEW—Ratchet Clutch operated by powerful relay, provides instant action, no slip.

NEW O-Ring Retainer permits quick removal of bakelite housing, exposing entire timer mechanism.

Timer driven by high torque (30 in. oz. at 1 r.p.m.) Cramer Type 112 Synchronous Motor.



The **R. W. CRAMER CO., Inc.**

SPECIALISTS IN TIME CONTROL
BOX 3, CENTERBROOK, CONNECTICUT

From
miniature relays
to
massive
radar systems . . .

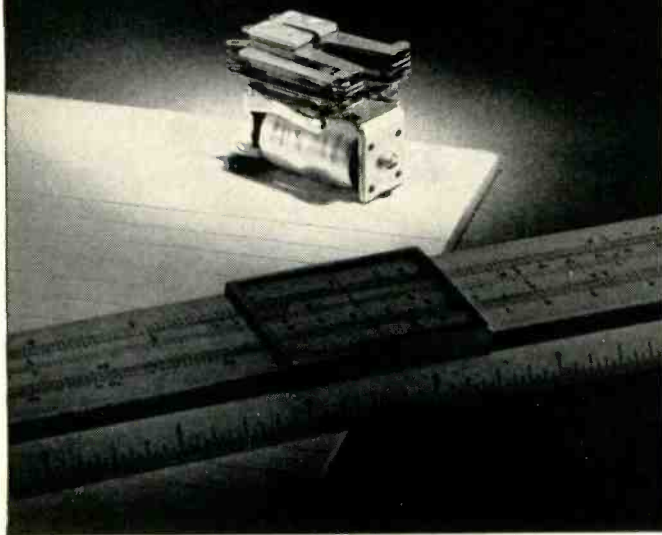

Producing small, sensitive electrical “nerves”, or constructing great penetrating radar “eyes” . . . each demands advanced technology. And these are but two of the *hundreds* of complex tasks the AMF organization performs every day.

The highly specialized yet widely diversified activities of some 35 engineering and production

facilities provide AMF with a wealth of experience that covers nearly every field of industry. And it is immediately available to *you*.

Call upon AMF with your problem. See for yourself why this all-around experience in answering the needs of government and industry alike has made AMF the “can do” company.

AMF HAS EXPERIENCE YOU CAN USE!



AMERICAN MACHINE & FOUNDRY COMPANY, Defense Products Group, 1101 N. Royal Street, Alexandria, Virginia
Executive Offices—AMF Building • 261 Madison Avenue, New York 16, N. Y.

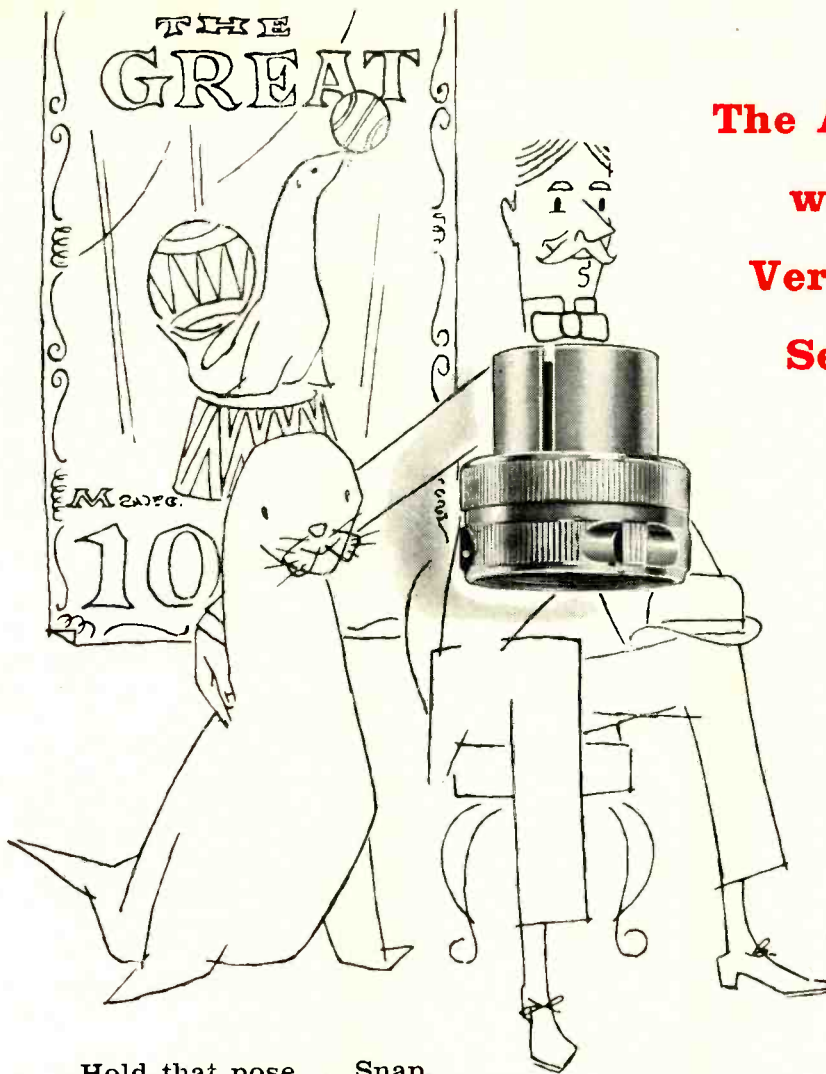

**The A-N Connector
with the
Versatile
Seal**

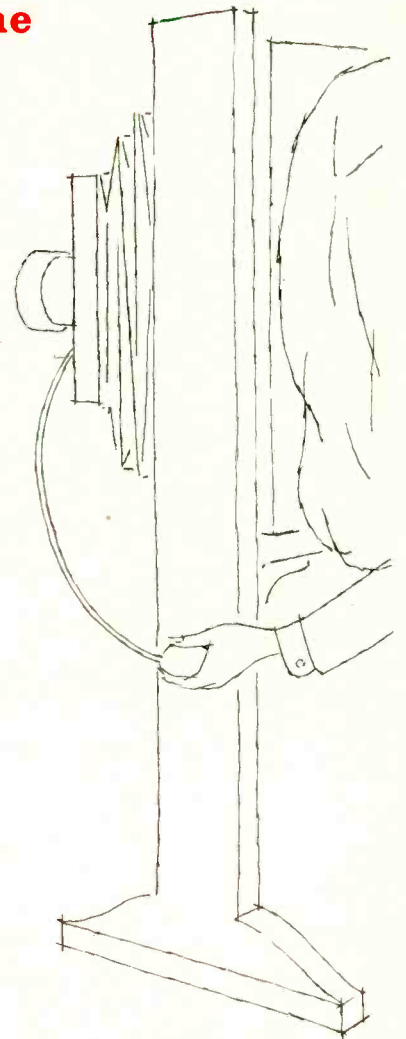

Hold that pose . . . Snap.

Truly a wonderful portrait of a long-lasting, beneficial association. The versatile seal around each pin in Hermetic HS 2 and HS 6 Connectors is of Vac-Tite, glass-to-metal construction. It assures superior, leak-proof performance.

By hermetically sealing the A-N Connector pins, Hermetic can offer as the solution to difficult instrumentation problems, these vitally important characteristics:

- Vacuum tightness (mass spectrometer proven)
- Arc-resistance of glass
- High-temperature operation
- Corrosion resistance
- 100% moisture and pressure resistance
- Shock and vibration proof
- Equivalent to MIL-C-5015



Yes, it's truly a wonderful portrait . . . a remarkable A-N Connector.

If your needs, however, require specially designed units with particular plating requirements, varied flange styles and extra-high pressure resistance, you will be pleased to learn of their availability.

Why not request drawings, engineering data and your copy of "Encyclopedia Hermetica" for the complete story.



Hermetic Seal Products Company

31 South 6th Street, Newark 7, New Jersey

California Associate: Glass-Solder Engineering, Pasadena



FIRST

AND FOREMOST IN MINIATURIZATION



TYPICAL LABORATORY BENCH SETUP shows how simple it is to hook up the input and load connections of the Solavolt for testing a fluorescent ballast at several different input voltages. It has attached input cord and plug, line on-off switch, and

three sinusoidal ac voltage outputs, all regulated within $\pm 1\%$: (1) a standard receptacle for fixed 115 volts (2) a standard receptacle for a variable output of 0-130 volts and (3) a pair of jacks for variable output of 0-130 volts.

$\pm 1\%$ Regulated AC Voltage Supply Adjustable from 0 to 130 Volts

When an adjustable source of regulated ac voltage is required for the accurate performance of a variety of electrical or electronic equipment, a Solavolt is often the simple, practical solution. It provides the close regulating action of a Sola Constant Voltage Transformer (a static-magnetic stabilizer) with less than 3% harmonic distortion of the output voltage wave.

Two of the Solavolt's three outputs are adjustable from 0 to 130 volts. The third provides a fixed 115 volts. All three outputs are regulated $\pm 1\%$ regardless of input changes from 95 to 125 volts, and may be used simultaneously within total maximum va rating.

Regulation is completely automatic and continuous with response time of 1.5 cycles or less. Except for the rotor of the autotransformer, there are no moving parts, and no manual adjustments are required. There are no tubes or other expendable parts.

The Solavolt is an ideal package unit, with carrying handle, where portability and compactness is a factor. It is particularly useful for general laboratory work, instrument calibration, testing, general shop use, or other similar applications. Solavolts are available from your electronic distributor in either 250va or 500va capacities.

SO LA *Constant Voltage*
TRANSFORMERS



Write for Bulletin 7K-CVL193 for full electrical and mechanical specifications of the Solavolt.

SOLA ELECTRIC CO.
4633 W. 16th St., Chicago 50, Ill.

CONSTANT VOLTAGE TRANSFORMERS for Regulation of Electronic and Electrical Equipment • LIGHTING TRANSFORMERS for All Types of Fluorescent and Mercury Vapor Lamps. • SOLA ELECTRIC CO., 4633 West 16th Street, Chicago 50, Illinois, Blshap 2-1414 • NEW YORK 35: 103 E. 125th St., Trafalgar 6-6464 • PHILADELPHIA: Commercial Trust Bldg., Rittenhouse 6-4988 • BOSTON: 272 Centre Street, Newton 58, Mass., Bigelow 4-3354 • CLEVELAND 15: 1836 Euclid Ave., Prospect 1-6400 • KANSAS CITY 2, MO.: 406 W. 34th St., Jefferson 4382 • LOS ANGELES 23: 3138 E. Olympic Blvd., Angelus 9-9431 • TORONTO 9, ONTARIO: 617 Runnymede Rd., Lyndhurst 1654 • Representatives in Other Principal Cities



STANDARDIZE WITH CANNON



Standardize with Cannon Audio Connectors . . . designed to meet all audio equipment disconnect needs. Simplify circuitry and cabling. Get quiet, continuous operation with the standard connectors of the industry—Cannon Plugs.

You'll find exactly the type you need in 14 extensive series expressly designed for radio, sound, TV and related fields . . . in cord, rack or panel chassis, audio and low-level, portable, hermetic sealed, miniature and subminiature, and power-supply types. Standard equipment with leading manufacturers of electronic equipment. The old reliable "Latchlock" feature on Cannon microphone connectors . . . standard on top-ranking microphones.

Complete Audio Connector Bulletin is yours for the asking . . . D Series in separate bulletin coded D-4.



P series



X series

for simplified **AUDIO** circuitry!



BRS series



UA series



D series



U series



K series

CANNON PLUGS



Please refer to Dept. 120
CANNON ELECTRIC COMPANY
3209 Humboldt St.
Los Angeles 31, California

Factories in Los Angeles; East Haven; Toronto, Canada;
London, England. Licensees in Paris, Tokyo, Melbourne.
Representatives in all principal cities.
Distributors everywhere.

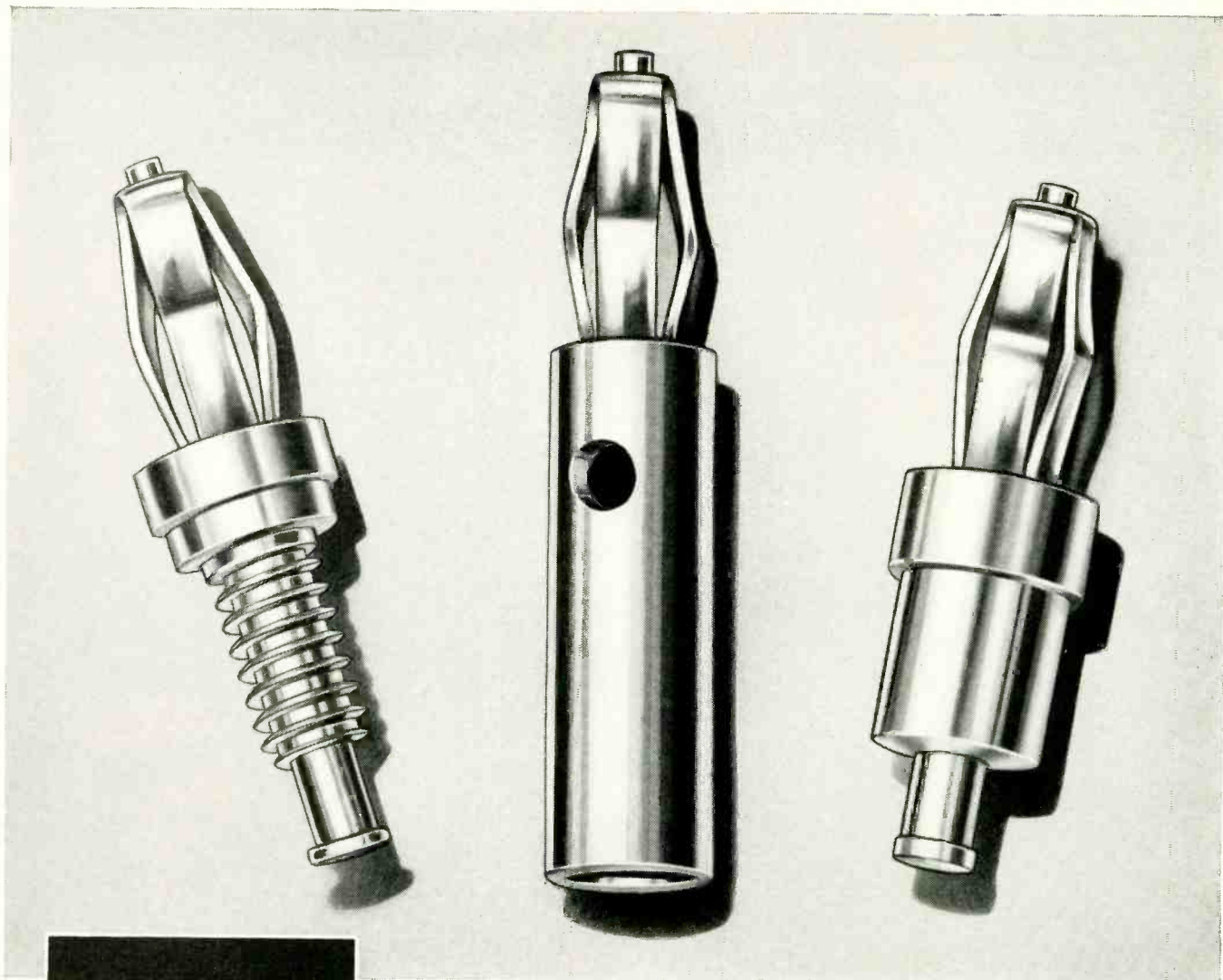

6 times enlargement

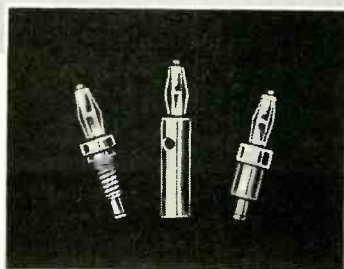

Actual size

Ucinite Miniature Banana Pins

Heavy resistance to torque is a big feature of Ucinite miniature banana pins. The springs are mechanically riveted over and the large area around the tip of the pin is bonded by solder.

Pins are available in a variety of types, for assembly by staking . . . with nuts and washers . . . with soldered tails . . . with multiple plug-in features. Springs are designed to fit .093 sockets.

Built to withstand rough usage, Ucinite miniature banana pins are available in cadmium, silver or gold plate.

For further information, call your nearest United-Carr representative or write directly to us.



The
UCINITE CO.
Newtonville 60, Mass.
Division of United-Carr Fastener Corp.

Specialists in
ELECTRICAL ASSEMBLIES,
RADIO AND AUTOMOTIVE

Bomac



... THE MOST COMPLETE LINE ...

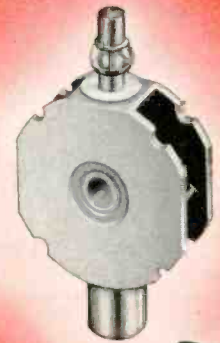
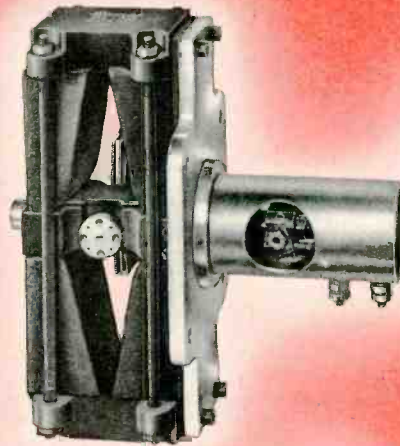
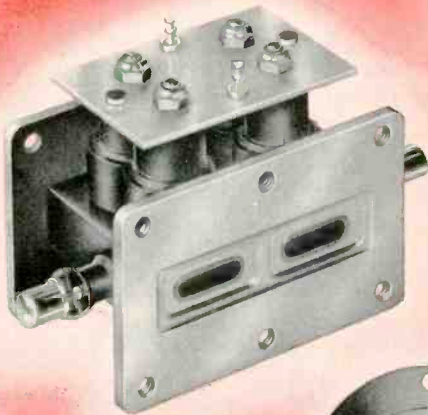

microwave tubes and components

GAS SWITCHING TUBES — Bomac produces the most extensive line of TR, ATR, Pre-TR, attenuator tubes, duplexers and shutter tubes available, for all frequency bands and power levels.

HYDROGEN THYRATRONS — Bomac offers a complete line for use as switch tubes in line type modulators for pulsing magnetrons in radar equipment. Also used for precise triggering at high power levels.

PRESSURIZING WINDOWS — Bomac has windows available for all wave guide sizes, broad band characteristics with low insertion loss, temperature range

—55°C to 100°C and 30 lb./sq. in. pressure differential either direction.

SILICON DIODES — Bomac diodes are manufactured to high standards to assure electrical uniformity, high burnout and humidity resistance.

MAGNETRONS — Bomac has available tunable and fixed tuned magnetrons with high peak RF powers for pulsed service in the higher frequency bands.

REFLEX KLYSTRONS — Bomac now offers X band klystrons having improved local oscillator performance and dependability.

We invite your inquiries regarding

- ENGINEERING
- DEVELOPMENT
- PRODUCTION

Bomac Laboratories, Inc.

BEVERLY, MASSACHUSETTS

Offices in major cities:—Chicago · Kansas City · Los Angeles · Dallas · Dayton
Washington · Seattle · San Francisco · Toronto

Export:—Maurice I. Parisier, 1860 Broadway, N. Y. C.

Catalog on request.
Write (on your company letterhead)
Dept. E-11 BOMAC
Laboratories, Inc.
Beverly, Mass.

CHOOSE YOUR 2 ϕ SERVO



These high performance 400 cycle servos conform dimensionally with Bu Ord specs in many models. Greater efficiency, minimum air gaps and extremely high torque-to-inertia ratio is attained by precision manufacturing. 60 cycle units can be made available.

Type Number	Size	Length	Mounting	Minimum Stall Torque In Oz.	No Load Speed Minimum	Power Input at Stall Total Watts	Rated Voltage		Special Features
							Fixed Phase	Control Phase	
1916	10	1 3/16"	Flange	.15	9,000	3	28	28	
2409	10	1 3/16"	Flange	.13	9,000	2.3	18	18	HI Temp application
2155	10	31/32"	Synchro	.24	4,800	4.5	52	52	
2162	10	31/32"	Synchro	.24	4,800	5.5	26	26	
2201	10	31/32"	Synchro	.24	5,000	5.2	26	52	
2442	10	1.156"	Synchro	.13	10,000	3.2	18	18	
3009	10	1.156"	Synchro	.3	10,000	2.5	18	54	1400 OHM cont. ph. Z
3040	10	.975"	Synchro	.149	10,000	2.6	18	54	1400 OHM cont. ph. Z
3053	10	.975"	Synchro	.15	10,000	2.8	18	18	
3185	10	.968"	Synchro	.3	6,000	6.2	26	26	avail. up to 125°C
2156	980" OD	.525"	Synchro	.15	6,000	5	27.5	14	125°C
2307	1" OD	1.5"	Synchro	.25	10,000	10	115	115	
3188	1" OD	1.511"	Flat	.35	10,000	12.6	115	115	
3199	11	1.703"	Synchro	.63	6,200	7	115	115	Mark 14 Mod O
3161	15	1.812"	Flange	.45	000	5.8	26	50	
3148	15	1.640"	Synchro	1.45	4,800	12.2	115	115	Mark 7 Mod O
2287	15	1.640"	Synchro	1.45	4,800	12.2	115	115	avail. up to 150°C
3159	15	1.640"	Synchro	1.45	4,800	12.2	115	230	
3271	15	1.640"	Synchro	1.0	10,000		115	115	
3272	15	1.640"	Synchro	1.0	10,000		115	230	
3273	18	2"	Synchro	2.35	4,800	18.4	115	115	
3217	18	2"	Synchro	2.35	4,800	18.5	115	282	
3270	18	2"	Synchro	4	9,800	18.0	115	115	
2094	2" OD	2.718"	Flange	3.5	7,200	40	115	115	Damping Generator
2237	2 7/8" OD	4.750"	Synchro	23	10,000	130	115	115	

Many of the above units can be supplied with gear train to your specifications. Other servos to your requirements.

Write for further details, giving type number.

Other products include Actuators, AC Drive Motors, DC Motors, Motor-Gear-Trains, Fast Response Resolvers, Servo Torque Units, Synchros, Reference Generators, Tachometer Generators, and Motor Driven Blower and Fan Assemblies.

John Oster
MANUFACTURING CO.
 Your Rotating Equipment Specialist

avionic division
 RACINE, WISCONSIN

BURTON BROWNE ADVERTISING

WHEN YOU NEED CERAMICS...
COME TO CERAMICS HEADQUARTERS!

General Ceramics

- FAST DELIVERY ON
LARGE PRODUCTION
RUNS
- HIGH, UNIFORM
QUALITY
- STANDARDIZED
TOOLING OFFERING
LOWEST COSTS

SOCKET BODIES
TRIMMER BASES
SWITCH INSULATORS
TERMINAL BUSHINGS
REFRACTORY DIELECTRICS

STEATITES—For extremely low loss at high frequencies. High dielectric strength through wide range of temperature. Close mechanical tolerances. Economical general purpose material for high quality electrical insulating applications.

PORCELAINS—An economical high voltage material of good mechanical and dielectric strength. Low thermal expansion. Good resistance to heat shock.

ZIRCONS—Combine low loss properties at high frequencies with very great resistance to heat shock and mechanical stresses.

ALUMINAS—Characterized by very great hardness and extreme resistance to heat shock and mechanical stresses. Will withstand high operating temperatures.

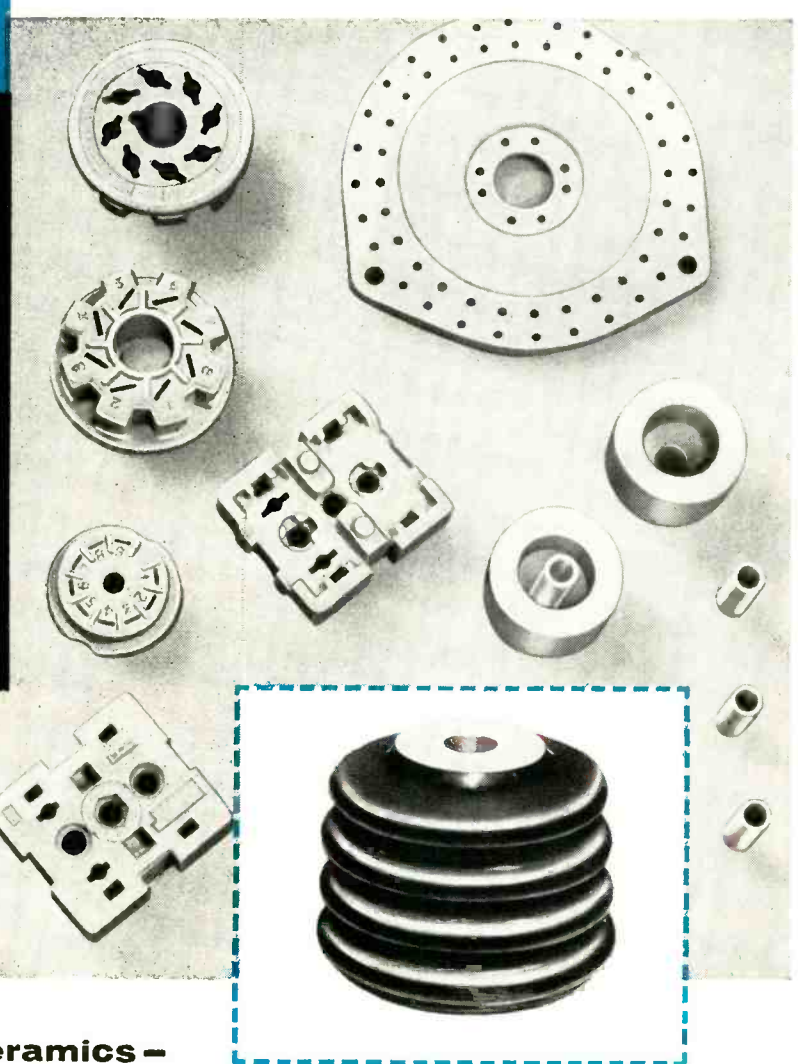

**ONE source of supply
for ALL electrical ceramics—**

For dependable quality and "on time" deliveries, General Ceramics can meet your requirements for electrical ceramics that conform to your assembly line schedules. Standardized designs, lowest tooling costs and modern method of manufacture assure

lowest possible cost per unit. Close adherence to specifications and strict final inspection minimize rejects, speed your assembly. When specifications call for ceramics, consult ceramics headquarters! Call, wire or write for estimates.



General **CERAMICS CORPORATION**
TELEPHONE: VALLEY 6-5100
GENERAL OFFICES and PLANT: KEASBEY, NEW JERSEY

MAKERS OF STEATITE, ALUMINA, ZIRCON, PORCELAIN, SOLDERSEAL TERMINALS, "ADVAC" HIGH TEMPERATURE SEALS, CHEMICAL STONWARE, IMPERVIOUS GRAPHITE, FERRIMIC MAGNETIC CORES

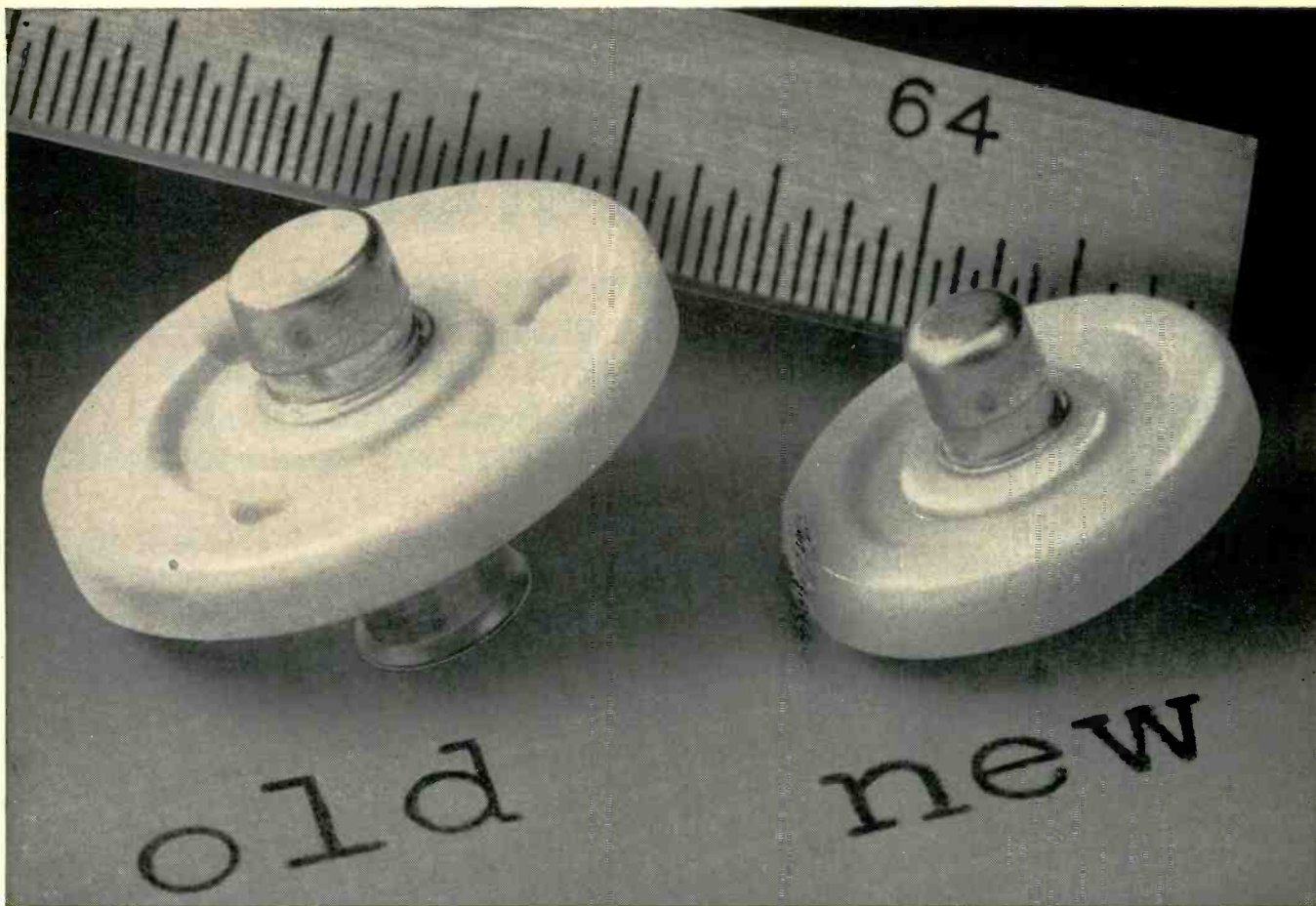

New miniature disc cathode shank diameter and length are reduced by approximately 25% from the previous model. Ceramic

also is about 25% smaller. Concentric groove in ceramic inhibits leakage from sublimation deposits. Magnification 8x.

NEW SUPERIOR TUBE MINIATURE DISC CATHODE SAVES 25% SPACE, UP TO 50% HEATER POWER

Up to now, practically all cathode ray tubes were equipped with disc cathodes as large as the one shown on the left in the above picture. But since the aperture in the first grid of most cathode ray tubes is normally so much smaller than the cap of the cathode, Superior Tube engineers reasoned that the cathode could be smaller and still give as good emission. They were right. The new cathode is shown above.

Think what this means: Tri-gun color TV tubes can have more slender necks. So also can multi-gun special purpose cathode ray tubes. Cost can be saved in the glass, the base, and the socket. Even single gun tubes can benefit. Less metal and ceramic means a lower heater power requirement.

These miniature disc cathodes are available in all regular Superior Tube cathode alloys. Ceramics can be either 0.365" or 0.490" dia., with or without breather holes. Cap to ceramic dimensional tolerance (the "E" dimension) guaranteed within $\pm .0005$ ".

Ask for a sample quantity of these new cathodes and try them for performance. Write for engineering information. Superior Tube Company, 2500 Germantown Ave., Norristown, Pa.

All analyses
.010" to $\frac{3}{8}$ " O.D.
Certain analyses in
light walls up to
 $2\frac{1}{2}$ " O.D.

Superior Tube
The big name in small tubing



Radius of Curvature of edge of cap lessens the danger of high temperature "dishing" frequently experienced with large area, sharp edge cathodes. "Dishing" would affect cut-off voltage of tube, require use of more expensive variable resistor in grid circuit. A small flat surface is retained to provide a satisfactory source of emission current.

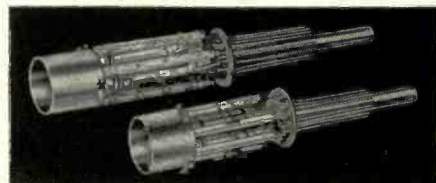

Size Comparison of Color TV Guns. Note how much more compact gun can be with miniature disc cathodes. Permits more slender tube neck.

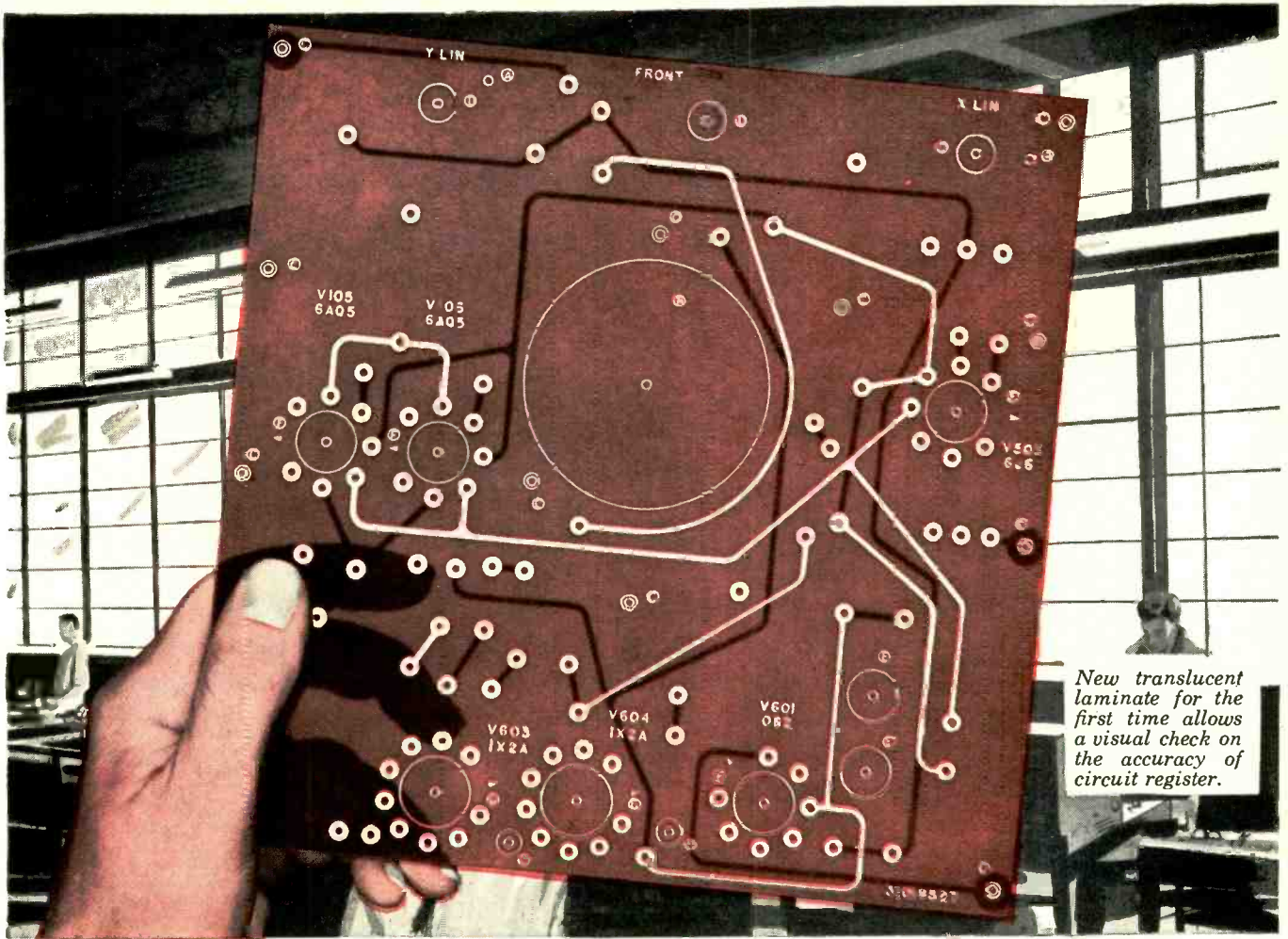

New translucent laminate for the first time allows a visual check on the accuracy of circuit register.

Formica Research perfects sensational new cold punching laminate

Brings 1,000,000 megohms resistance value, precision and translucency to printed circuitry

Research, an important part of the exclusive new Formica 4-point service, has just perfected a new cold punching paper base laminate offering 1,000,000 megohms insulation resistance and valuable new translucent properties.

Known as XXXP-36, the new grade brings greater accuracy to printed circuitry. Because of its cold punching qualities, XXXP-36 requires no heat cycle. Therefore, the base laminate is not subject to dimensional

change as in grades which must be heated before punching. This means that with Formica XXXP-36, you can now produce printed circuits with new and higher standards of accuracy.

XXXP-36 translucency can be doubly useful. Make this simple test: hold it to the light. You can see (1) the smooth, homogenous structure, the total absence of resin pockets, voids and imperfections that dissipate the insulating properties of ordinary paper base

laminates . . . and (2) how perfectly the circuit on one side registers with that on the other. New XXXP-36 is ideal for terminal boards and tv insulators requiring high I. R. Formica's engineering skill can help you find new materials for new products and processes. For complete information on the new XXXP-36, or on the new "Formica-4" service, use coupon below. The Formica Co., 4640 Spring Grove Ave., Cincinnati 32, Ohio.



FORMICA®—the most famous name in laminated plastics—Engineered for industry, Beauty Bonded for the home.

Make the Formica Translucency Test. Send for a sample XXXP-36 printed circuit. Fill out and mail coupon today.

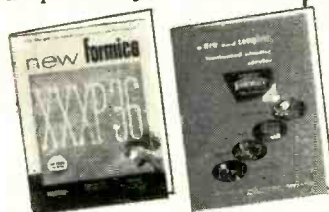

Gentlemen:

- I'd like a sample XXXP-36 printed circuit and complete information on this new grade.
- Send bulletin showing how I can take advantage of the new "Formica-4" laminated plastics service.

Name _____
 Company _____ Title _____
 Address _____
 City _____ Zone _____ State _____

Up where the

ATOMIC BOMB LETS GO

Split Seconds Seem Like Eternity

...the nuclear device itself must be armed and fired. These and hundreds of similar details must be taken care of without fail in proper order and at predetermined times in order that the desired information be obtained. This control is provided by a device known as a "sequence timer" located in the control room. The timer sends out electric signals which acti

THIS EXCERPT from the "Guide for Observers' Tour of the Control Point and Forward Area, Nevada Proving Grounds" highlights the importance of equipment capable of accurately measuring elapsed time down to unbelievably short intervals.

The first section of the panel shown below is used only for air bursts. The second and third sections contain the frequency control equipment for the motor-generator set which supplies power to the timing equipment, with voltage recorders connected to various points in the target area — thus assuring accurate timing — and recorders for wind velocity and direction. In order to activate test equipment at the exact time, very precise control of the frequency for the timer is required... The precision timers on the fourth and seventh sections are by STANDARD.

Complex instrument panel in Control room of Control Point, Yucca Pass, Nevada Proving Grounds

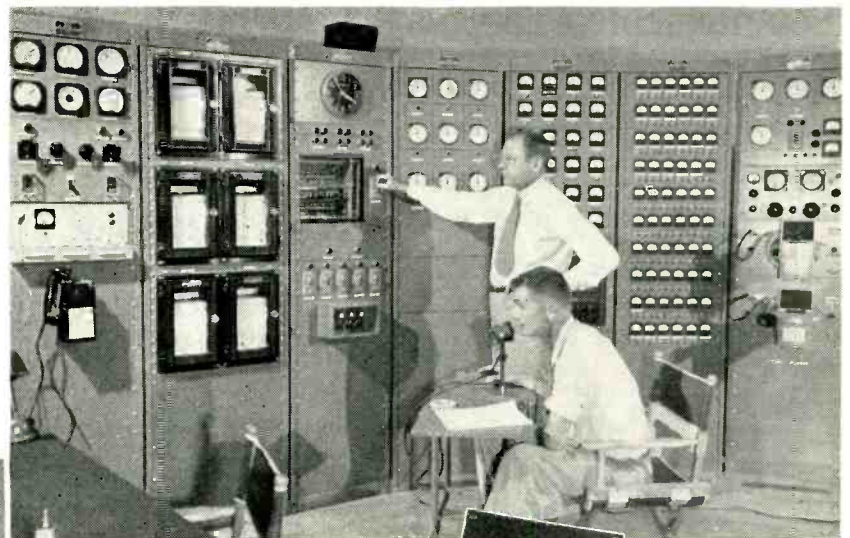

The STANDARD ELECTRIC TIME COMPANY

STANDARD

97 LOGAN STREET • SPRINGFIELD 2, MASSACHUSETTS

Since 1884

PRECISION TIMERS • CHRONO-TACHOMETERS • LABORATORY PANELS • PIPELINE NETWORK ANALYZERS

Completely new!

1 cps to 1 MC Square Wave Generator with 0.02 μ sec rise time

Other Unusual Features

7 volt 75 ohm TV circuit

55 volt 600 ohm high level circuit

Full amplitude variation

External synchronization



SPECIFICATIONS

Frequency Range: 1 cps to 1 MC, continuous coverage.

Low Impedance Output: 7.0 v peak-to-peak across 75 ohm internal impedance. Rise time less than 0.02 μ sec. BNC Connector.

High Impedance Output: 55 v peak-to-peak across 600 ohm internal impedance. Rise time less than 0.1 μ sec. Dual banana jacks — $\frac{3}{4}$ " centers.

Amplitude Control: Low Impedance Output — Potentiometer and 60 db attenuator, variable in 20 db steps. High Impedance Output — Potentiometer.

Frequency Control: Dial calibrated "1 to 10" and decade multiplier switch. Six bands.

Symmetry Control: Allows exact square-wave balance.

Sync Input: Positive-going pulse or sine wave signal, minimum amplitude 5 volts peak. BNC connector.

Power: 115/230 v $\pm 10\%$, 50/60 cps, 195 watts.

Size: $9\frac{3}{4}$ " wide, $13\frac{7}{8}$ " high, $13\frac{3}{8}$ " deep.

Weight: Net 22 lbs.; Shipping 44 lbs.

Price: \$265.00.

Data subject to change without notice. Prices f.o.b. factory.



**Complete Coverage,
Highest Quality**

The new *-hp-* 211A Square Wave Generator permits fast measurement of audio and video amplifier frequency phase and transient characteristics up to several megacycles. In computer, pulse code and telemetering work, it materially simplifies triggering and switching. It is excellent for testing television circuitry, and ideal for modulating high frequency circuits, testing attenuators, filters and delay lines. In general laboratory use it is an excellent means of measuring time constants, indicating phase shift, frequency response and transient response.

Model 211A has many unique features. Besides the 0.02 μ sec rise time and two separate outputs (with full amplitude variation on both), the generator can be operated either free-running or externally synchronized. External synchronizing can be either with a positive going pulse or a sine wave signal of 3 volts amplitude. Much of the instrument's circuitry is etched to provide clean, trouble-free layout, compact size, freedom from stray capacity variations, and thus, a highly uniform product. The generator is of quality construction throughout and is housed in a streamlined, lightweight metal cabinet.

SEND FOR OPERATING TECHNIQUES, CAPABILITIES, COMPLETE DATA

HEWLETT-PACKARD COMPANY

3331A PAGE MILL ROAD., PALO ALTO, CALIFORNIA

Please send complete data on *-hp-* 211A Square Wave Generator

Name _____

Company _____

Street _____

City _____ Zone _____ State _____

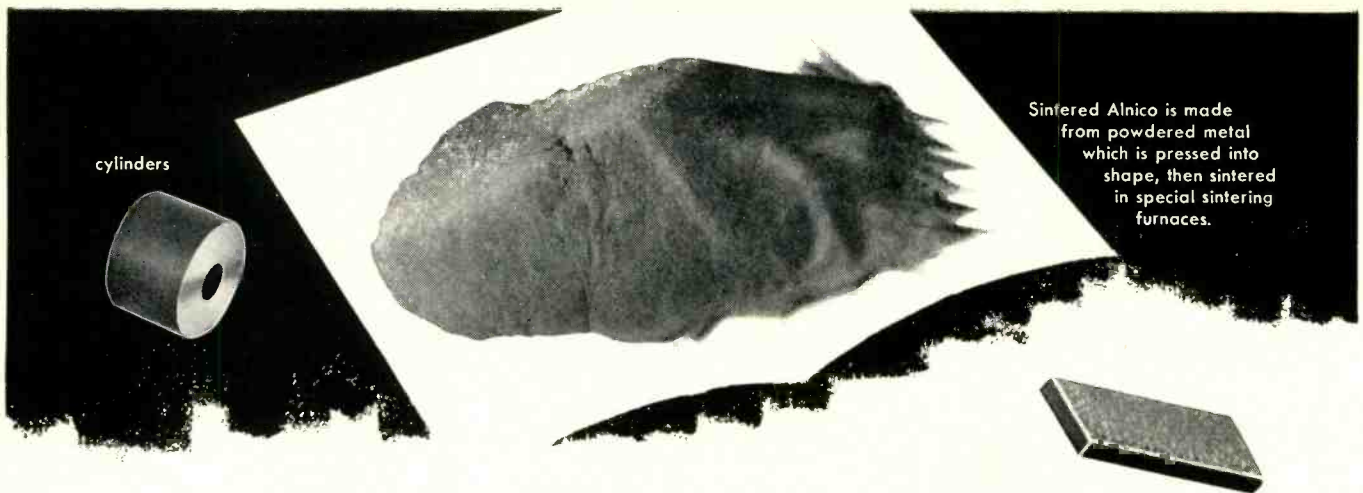

Sintered Alnico is made from powdered metal which is pressed into shape, then sintered in special sintering furnaces.

24-hour service on SINTERED ALNICO MAGNETS .. from stock

Indiana Sintered Permanent Magnets are available for your development work in dozens of *standard* sizes and shapes.

Fast, 24-hour shipment on Sintered Alnico II Magnets can be made *from stock*. Sintered permanent magnets are also available, on special order, in Alnico grades IV, V, and VI.

For a complete assortment of sizes and shapes to choose from, write for 12-page

Sintered Catalog No. 12-A11. Or, if you're not sure what type of magnet or grade of material to use, consult Indiana's engineers for their recommendations, without obligation, of course. Their 47 years of experience in designing magnets for some 40,000 designs is your assurance that the most efficient and economical magnet is chosen for your product.

**INDIANA
PERMANENT
MAGNETS**

THE INDIANA STEEL PRODUCTS COMPANY
VALPARAISO, INDIANA

World's

Largest Manufacturer of Permanent Magnets



Sintered Alnico

PROPERTIES	ALNICO II*	ALNICO IV	ALNICO V	ALNICO VI
Residual induction (minimum) Br Gauss	6900	5200	10500	8800
Coercive force (minimum) Hc Oersteds	520	700	600	780
Energy product (minimum) BdHd max x 10 ⁶	1.45	1.2	3.5	3.0
Peak magnetizing force—Oersteds	2000	3000	3000	3000
Weight—lb/cu. in. Mechanical properties	.249 Hard	.250 Hard	.260 Hard- brittle	.260 Hard- brittle

*Alnico II only, available from stock.

STANDARD . . .
on the ultra-modern
DOUGLAS DC-7C

BENEFITS NEVER BEFORE POSSIBLE

- no annoying ear-popping
- simple controls — automatic, reliable
- far less maintenance
No sensor contacts or filters to clean.
- completely electrical
No complex tubing.
- lower cost
- lighter weight
As much as 60% lighter!
- easily retrofitted in
any existing aircraft
- particularly adaptable to future
high performance air transports

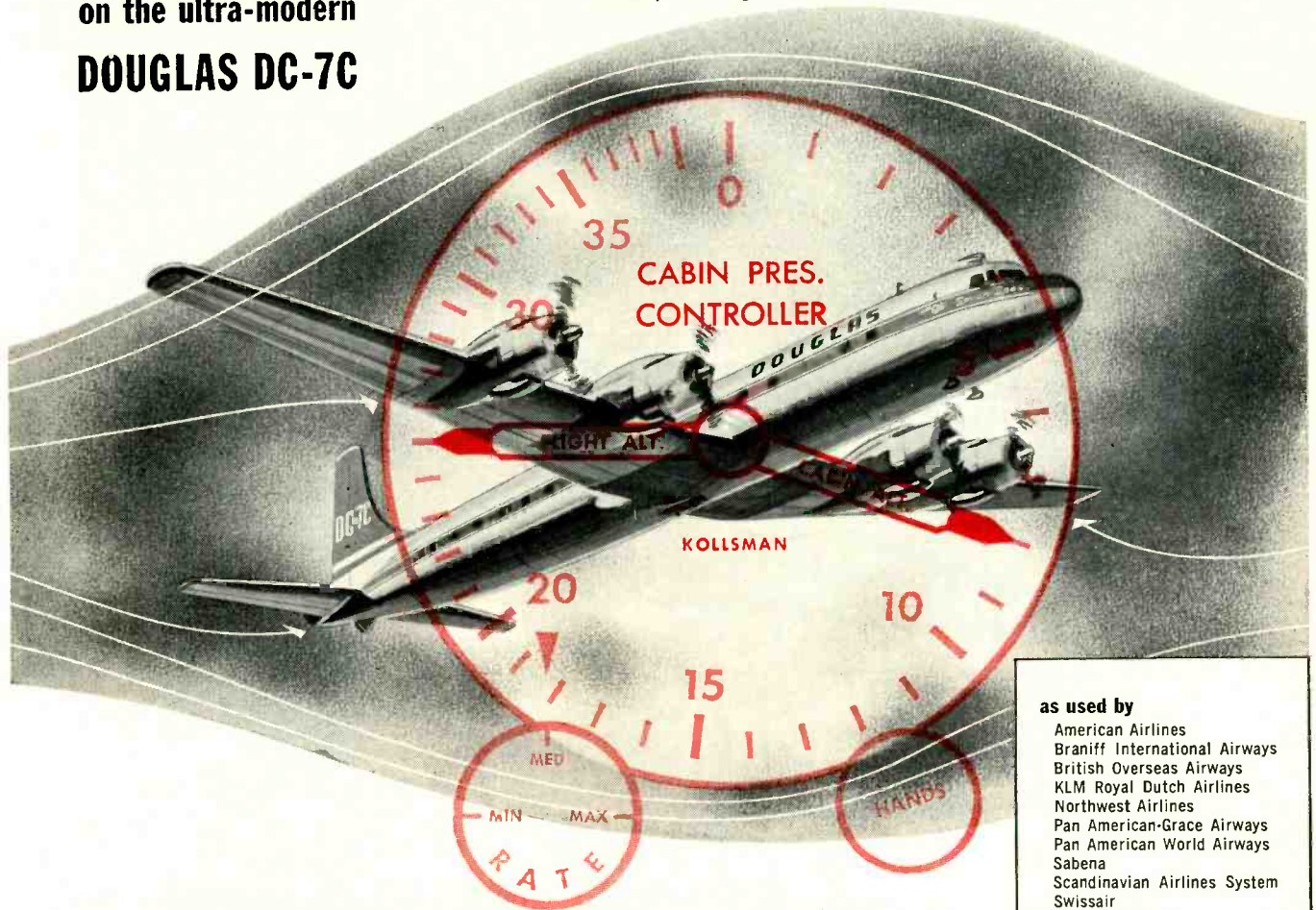

- as used by**
- American Airlines
 - Braniff International Airways
 - British Overseas Airways
 - KLM Royal Dutch Airlines
 - Northwest Airlines
 - Pan American-Grace Airways
 - Pan American World Airways
 - Sabena
 - Scandinavian Airlines System
 - Swissair
 - United Air Lines
 - Western Air Lines

new KOLLSMAN KS-54 cabin pressure control system

DOUGLAS chose the new Kollsman KS-54 Cabin Pressure Control System for their new DC-7C's because of the many decided advantages it offers over the other existing systems.

LIVING-ROOM COMFORT IN THE CABIN . . . There is no annoying ear-popping because cabin pressure is held practically constant under cruising conditions. Even when cabin pressure is changing, the rate of change is so smoothly controlled that the actual change of pressure is unnoticeable.

PEACE OF MIND IN THE COCKPIT . . . When the controls are set, the system is fully automatic and thoroughly reliable — especially so because of the simplicity of the Kollsman design.

NO WORRY IN THE MAINTENANCE SHOP . . . The components are simple and rugged, proven dependable and require a minimum of maintenance. There are no sensor contacts or filters to clean, no complex tubing to worry about.

WRITE for special folder giving full technical details on the new Kollsman KS-54 System, or ask to have a sales engineer visit you.



80-10A 45th AVE., ELMHURST, NEW YORK • GLENDALE, CALIFORNIA • SUBSIDIARY OF *Standard* COIL PRODUCTS CO. INC.

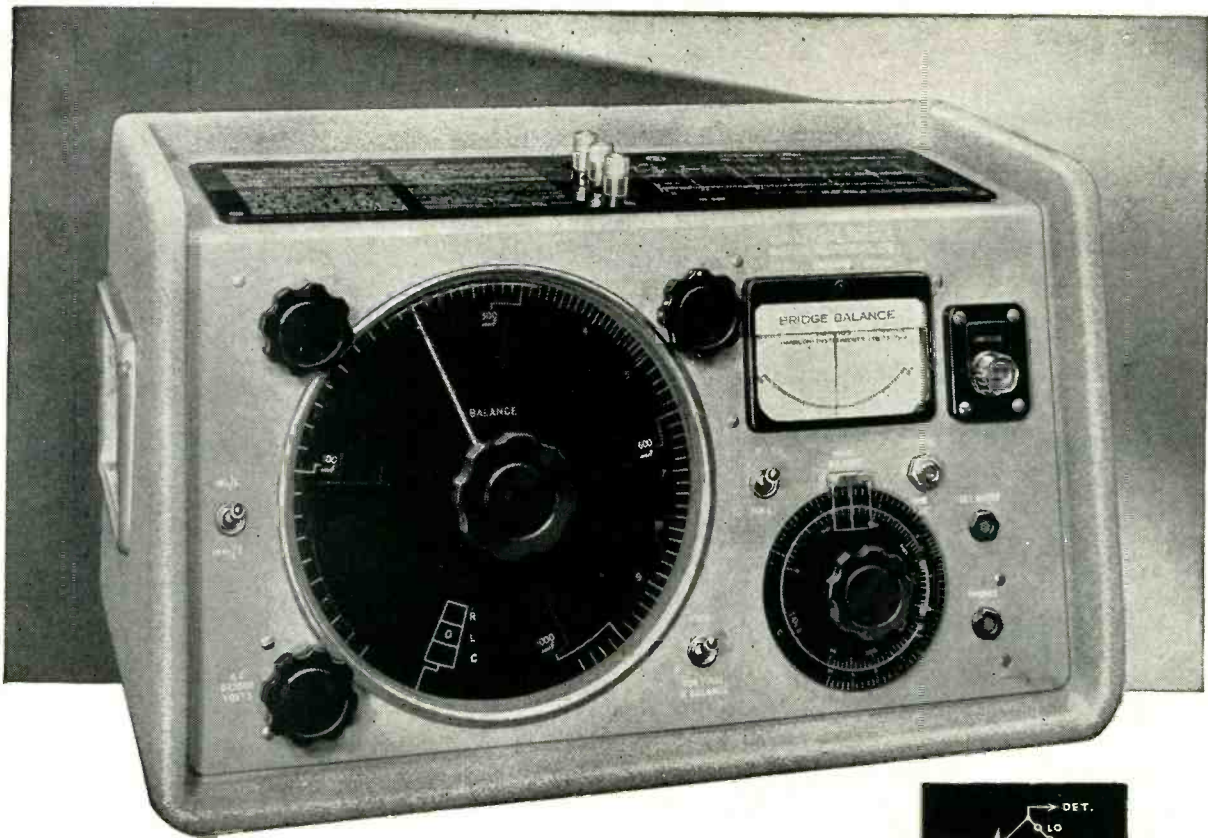

ACCURATELY MEASURED

L - AT 1 OR 10 kc
C - AT 1 OR 10 kc
R - AT D.C.

INDUCTANCE, CAPACITANCE, RESISTANCE and power factor measured quickly and accurately on this self-contained and robust instrument. Its industrial-designed appearance fits well in modern surroundings and partners its outstanding electrical performance.

UNIVERSAL BRIDGE TYPE TF 868/I

Inductance from $1\mu\text{H}$ to 100H , Capacitance from $1\mu\mu\text{F}$ to $100\mu\text{F}$, and Resistance from 0.1Ω to $10\text{M}\Omega$.

Single direct reading L.C.R. dial — no multiplying factors involved.

Continuously variable a.c. bridge voltage and automatic detector sensitivity control.

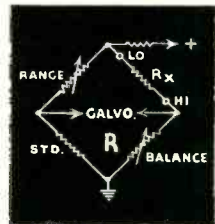
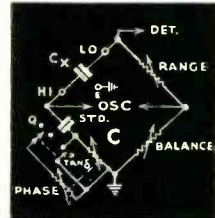
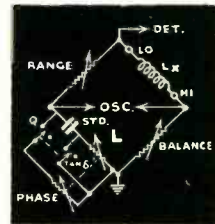

MARCONI INSTRUMENTS

44 NEW STREET · NEW YORK 4

CANADA: CANADIAN MARCONI CO., MARCONI BUILDING, 2442 TRENTON AVENUE, MONTREAL
 ENGLAND: Head Office: MARCONI INSTRUMENTS LIMITED, ST. ALBANS, HERTFORDSHIRE

Managing Agents in Export: MARCONI'S WIRELESS TELEGRAPH COMPANY LIMITED, MARCONI HOUSE, STRAND, LONDON, W.C.2

MINIATURE CIRCUIT BREAKER

Let's look into this

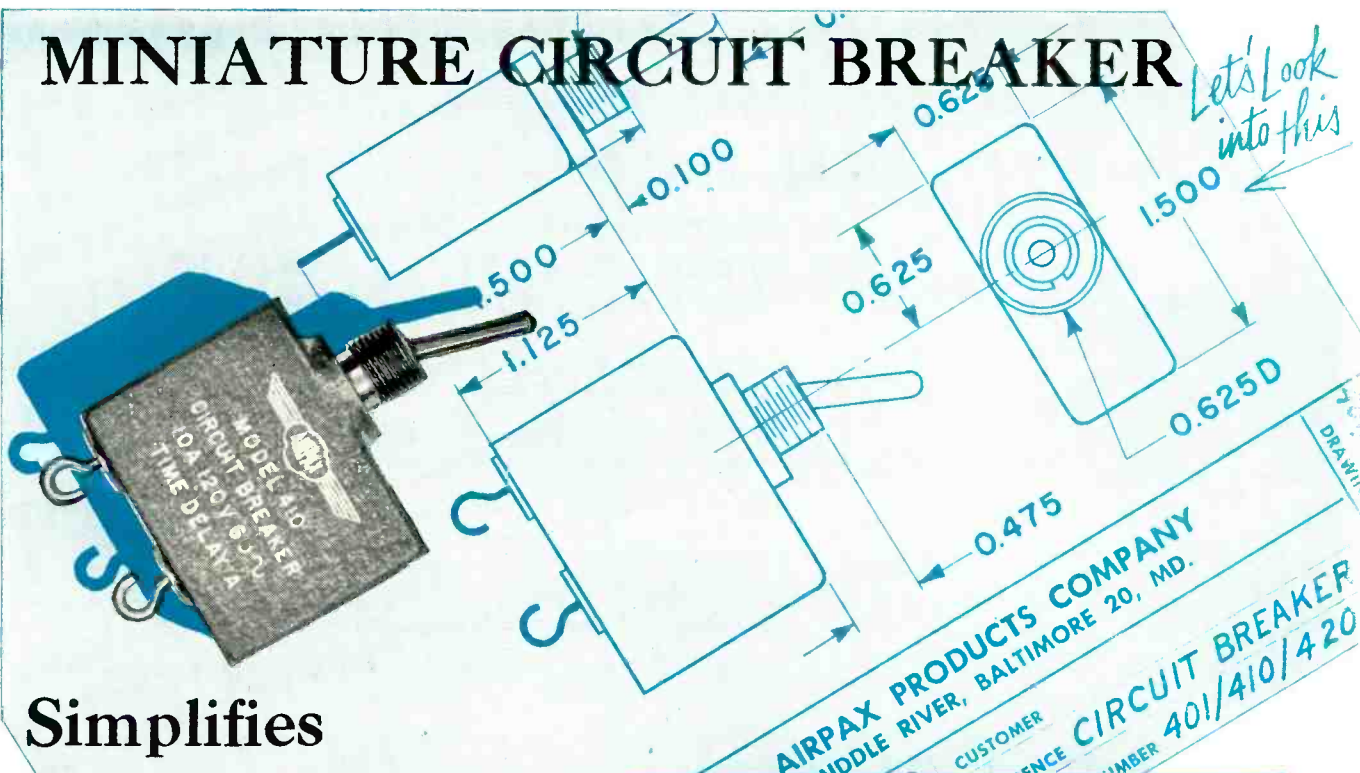

Simplifies Circuit Design

You can now perform the *two* functions of power ON-OFF control and circuit protection with *one* miniature fully magnetic time-delay trip-free circuit breaker. Save space (see diagram above); save weight (weighs less than 2 oz). The characteristics (tabulated at right) of this new Airpax component show it to be a significant advance in power control; just what you need.

Handle has ON and OFF positions; it moves to OFF position when breaker trips, yet breaker cannot be prevented from tripping by holding handle in ON position. Stable tripping mechanism assures reliable operation even under adverse temperature and vibration. Give your equipment the protection it deserves.

To restore service after fault has been removed, simply reset the breaker. A breaker having a 30-sec time delay recovers full delay in about 20 sec.

To receive complete engineering data, simply write to

CHARACTERISTICS

RATINGS: 0.05 amp to 10 amp at 50 V DC or 1.0 to 10 amp at 120 V AC

MINIMUM TRIP: 125% of rated load

INSTANTANEOUS TRIP: 1,000% of rated load

INTERRUPTING CAPACITY: a typical value is 500 amp at 30 V DC

POWER CONSUMPTION: 0.6 watt in lower current ratings, rising to about 2 watts at 10 amp rating

SHOCK: resists 50 g in all directions

VIBRATION: 10 to 55 CPS at 0.06 in. total excursion in all directions

TEMPERATURE: -40 C to +100 C

LIFE: 10,000 operations at rated current into resistive load

ENCLOSURE: hermetically sealed



MIDDLE RIVER

BALTIMORE 20, MD

Completely Insulated for stability under long, hard operating conditions

There's nothing else like

ISO-KAP*

Centralab's New Molded Disc Ceramic Capacitor



Actual Size

Only one of its kind! The only molded, *completely* insulated, ceramic disc capacitor. Breakdown to ground in excess of 3000 V.D.C.

Strong! Unaffected by extremes of vibration; by ozone, salt water, or any known acid or solvent at room temperature.

Accurate! Thickness, diameter, and lead spacing are always exact. And leads are always on perfect center line—never offset. The answer for automatic assembly.

Dependable! New basic ceramic body. Capacitance characteristics are virtually flat over a wide temperature range.

Leads can't pull out! Lead strength is greater than the tensile strength of No. 22 wire.

Clearly labeled! Stamped with capacity, voltage rating, and tolerance.

Write for engineering bulletin EP-48, for facts and figures on Iso-Kap.

**More proof that
if it's a job
for electronic components,
it's a job for Centralab**

Centralab's advanced engineering continues to create the prototypes of the components industry



CERAMIC CAPACITORS



SWITCHES

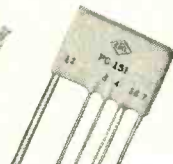

PACKAGED ELECTRONIC CIRCUITS

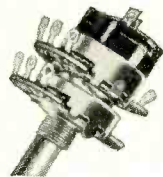

CONTROLS



STEATITE INSULATORS

D-5512



A DIVISION OF GLOBE-UNION INC.

914K E. Keefe Avenue • Milwaukee 1, Wisconsin
In Canada: 804 Mt. Pleasant Road, Toronto, Ontario

*Trademark

SINCE 1922, INDUSTRY'S GREATEST SOURCE OF STANDARD AND SPECIAL ELECTRONIC COMPONENTS

Electroni-Kwiz No. 9[†]

NEW THIS MONTH!

1st Prize—Two single electric blankets

Don't be fooled! You have a good chance to win. Simply answer this question in 50 words, more or less:

How do you feel personally about the matter of patent rights? Should they belong to the individual inventor—or to the company who employs him?

A leading editor will pick the winner of this month's major prize.

Mail your entry to us before November 30.

†Nothing to buy. Employees of Centralab and their advertising agency not eligible. Duplicate prizes awarded in case of tie. Entries become the property of Centralab—none can be returned.

TWO NEW PRODUCTS JOIN THE *LFE* FAMILY!

503

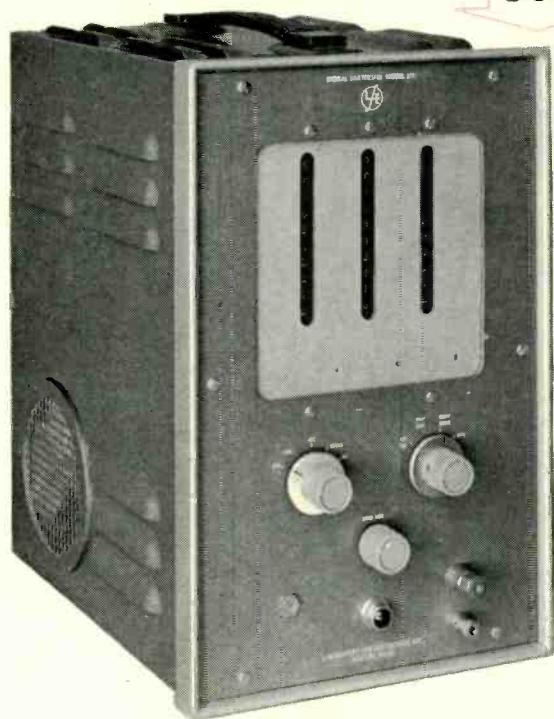

LFE MODEL 503

ELECTRONIC DIGITAL MULTITESTER

The 503 — a new type of electronic Multitester — presents display digitally — uses electronic counters.

Unique Model 503 uses three decade columns of neon lights for the indication — gives *absolute* readings — eliminates problems of parallax and ambiguity.

Rugged Model 503 is precise — dependable — lightweight.

And—the skill is in the instrument—so almost anyone can use it—confidently—efficiently—in shop or laboratory!

A PREDETERMINED COUNTER OF HIGH-SPEED VERSATILITY!

The "genius" of the LFE 502 lies in its ability not only to count a predetermined number of impulses, but also to use these pulses for control. So, when you buy the 502, you're buying both a Predetermined Counter and a control device in one compact instrument. Automatic sorting and packaging, control of motor speeds or machine tools, generation of precision delays, interval measurements — whatever counting and controlling task you assign the LFE 502, you can depend on this accurate, dependable, high-speed instrument to give you perfect satisfaction.

For specifications and more details about these new instruments, write for our free informative bulletins and the name of the LFE Engineering Representative nearest you. Inquiries on export sales should be addressed to: Andrew S. Szucs, Inc., 50 Broad St., New York 4, N. Y.

502

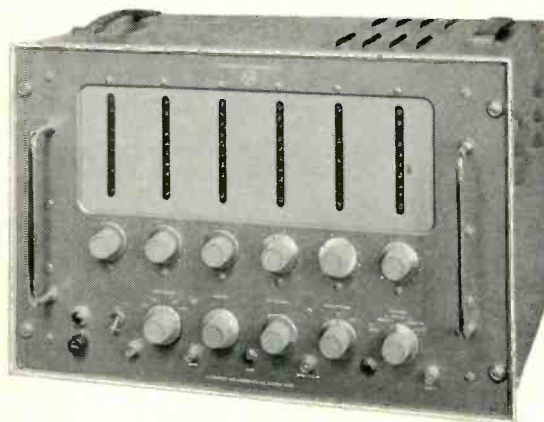

LABORATORY FOR ELECTRONICS, INC.
75 Pitts Street, Boston 14, Mass.

ARE YOU, LIKE SYLVANIA,

*Pushing to Higher
Frequencies?*

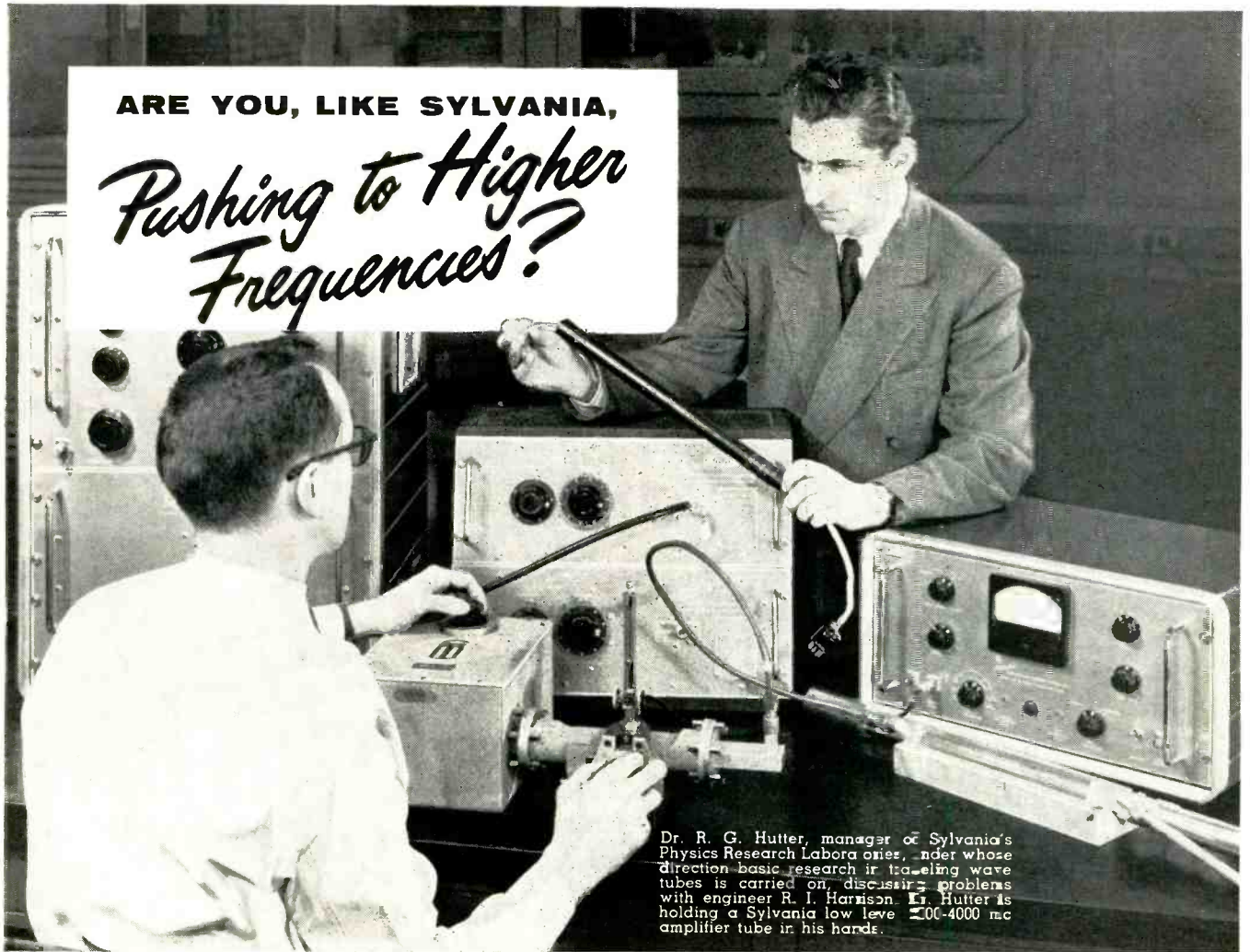

Dr. R. G. Hutter, manager of Sylvania's Physics Research Laboratories, under whose direction basic research in traveling wave tubes is carried on, discussing problems with engineer R. I. Harrison. Dr. Hutter is holding a Sylvania low level 200-4000 mc amplifier tube in his hands.

When Sylvania started out on a traveling wave tube program, their research engineers specified PRD test equipment. High quality was an important factor in their choice. In addition, they wanted a line of test equipment covering a wide frequency range to take care of future developments in higher frequencies.

If you, like Sylvania, are pushing to higher frequencies, you will be interested in PRD's full coverage and especially in the —

PRD MILLIMETER WAVEGUIDE TEST EQUIPMENT

Why? Because:

1. Precision really counts with millimeter equipment
2. PRD has pioneering experience in this field
3. The equipment is available now.



Write for
Complete
Catalog A

Polytechnic **RESEARCH
& DEVELOPMENT CO., INC.**

202 TILLARY STREET
BROOKLYN 1, N. Y.
Telephone: ULster 2-6800



Midwest Sales Office:
1 SOUTH NORTHWEST HIGHWAY, PARK RIDGE, ILLINOIS — Talcott 3-3174.
Western Sales Office:
737-41, SUITE 7, NO. SEWARD STREET, HOLLYWOOD 38, CAL. — HO 5-5287

ONLY THE LEADER

*always points
the way*

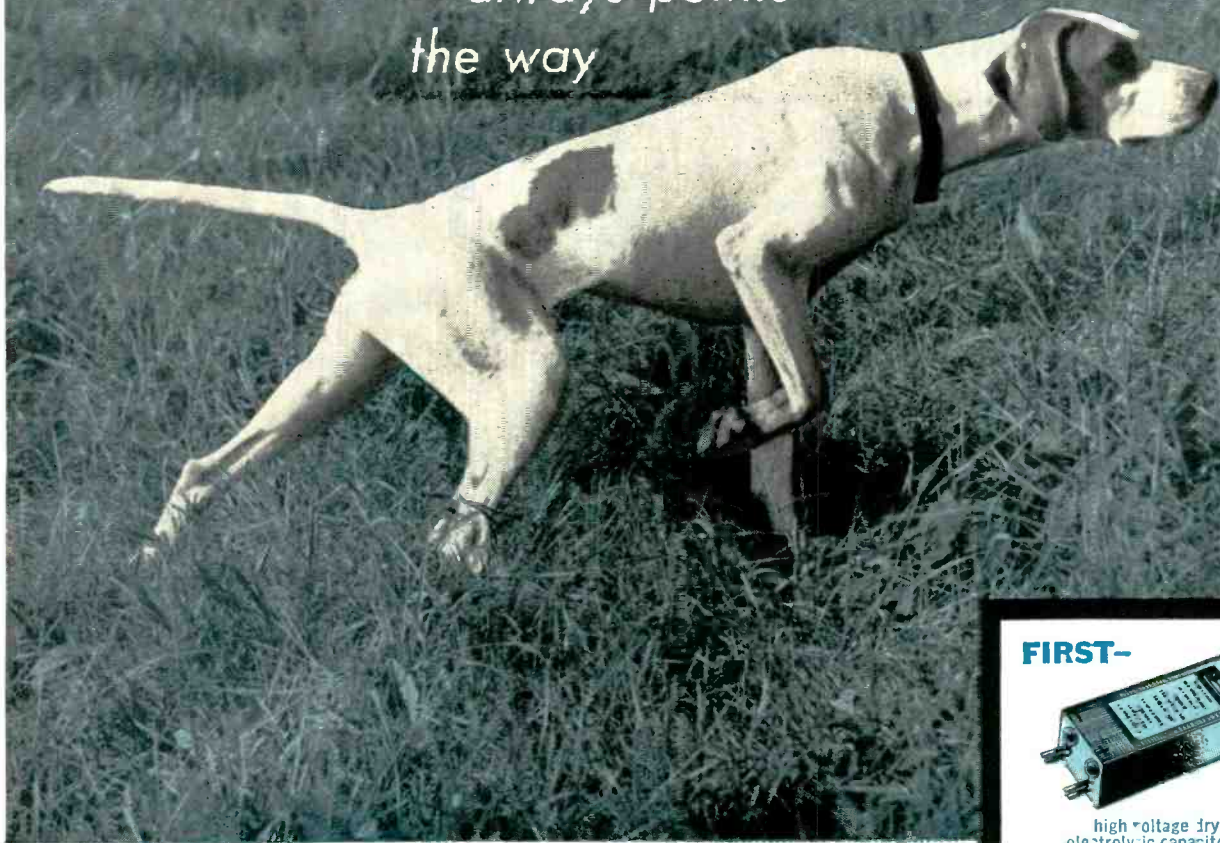

FIRST-



high-voltage dry electrolytic capacitors.

Pointing up progress in capacitor manufacturing is an old tradition at Cornell-Dubilier. Our list of new capacitor developments for every use began in 1910—with a record of consistent dependability and outstanding field performance, ever since.

FIRST-



capacitor to use anodic aluminum foil electrochemically etched.

C·D...45 YEARS OF FAMOUS FIRSTS

Typical of these "famous firsts" are the three examples shown here... *proof* that whatever your capacitor requirements may be, your needs can be filled by C·D. Write to Cornell-Dubilier Electric Corp., Dept. K-115, South Plainfield, N. J.

FIRST-



miniature, metal-cased electrolytic capacitors.



CONSISTENTLY DEPENDABLE CORNELL-DUBILIER CAPACITORS

PLANTS IN SO. PLAINFIELD, R. J.; NEW BEDFORD, WORCESTER AND CAMBRIDGE, MASS.; PROVIDENCE AND HOPE VALLEY, R. I.; INDIANAPOLIS, IND.; SANFORD AND FUQUAY SPRINGS, N. C.; SUBSIDIARY: RADIART CORP., CLEVELAND, OHIO.

THERE ARE MORE C·D CAPACITORS IN USE TODAY THAN ANY OTHER MAKE



versatile

Multi-channel --
telegraph A1 or
telephone A3.

FROM GROUND TO AIR OR POINT TO POINT

STABLE

High stability (.003%) under
normal operating
conditions.

RUGGED

**Components
conservatively
rated. Completely
tropicalized.**



Model 446 transmitter operates on 4 crystal-controlled frequencies (plus 2 closely spaced frequencies) in the band 2.5-24.0 Mcs (1.6-2.5 Mcs available). Operates on one frequency at a time; channeling time 2 seconds. Carrier power 350 watts, A1 or A3. Stability .003%. Operates in ambient -35° to 45°C. Nominal 220 volt, 50/60 cycle supply. Conservatively rated, sturdily constructed. Complete technical data on request.

Here's the ideal general-purpose high-frequency transmitter! Model 446... 4-channel, 6-frequency, medium power, high stability. Suitable for point-to-point or ground-to-air communication. Can be remotely located from operating position. Co-axial fitting to accept frequency shift signals.

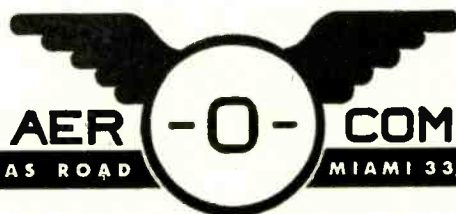

3090 DOUGLAS ROAD

MIAMI 33, FLA.

speaking of TV Quality...

HERE'S HOW TO GET MORE

at LESS COST!



A Stackpole Ceramagnet ring $3\frac{1}{8}$ " in diameter by $\frac{1}{2}$ " thick forms the "heart" of this efficient, magnetic focusing unit produced by Glaser-Steers Corporation, Belleville, N. J. The entire unit weighs less than 13 ounces.

Quick, accurate focusing is obtained with simplified gear arrangement.

FROM A COST STANDPOINT, magnetic focusing of television picture tubes paves the way to important cost savings by comparison with electrostatic tube focusing methods. In actual instances, material savings alone have run from 50c to \$1.

FROM A DESIGN STANDPOINT, magnetic focusing lends itself well to the trend toward increased second anode voltages.

FROM A PRODUCTION STANDPOINT, the predictable higher quality of magnetic tubes reduces incoming inspection costs. Factory focusing of sets is done in less time with less skilled labor.

FROM A PERFORMANCE STANDPOINT, magnetic focusing quality is generally superior, more stable, and more effective over the entire face of large tubes. Focusing is less affected by voltage changes. When tube replacement becomes necessary, servicing adjustment is a relatively simple matter.

STACKPOLE

Ceramagnet[®]
CERAMIC MAGNETS

Magnetic picture tube focusing is but one of countless jobs, both electrical and mechanical, that can be done better and at less cost with this unique new Stackpole ceramic magnetic material.

Ceramagnet is highly uniform, powerful and permanent. Available in almost any shape or size, it opens important new engineering horizons wherever dependable, low cost magnetic attraction, repelling or even "cushioning" may be utilized.

Send details of your application for recommendations and Ceramagnet samples.

Electronic Components Division

STACKPOLE CARBON COMPANY, St. Marys, Pa.

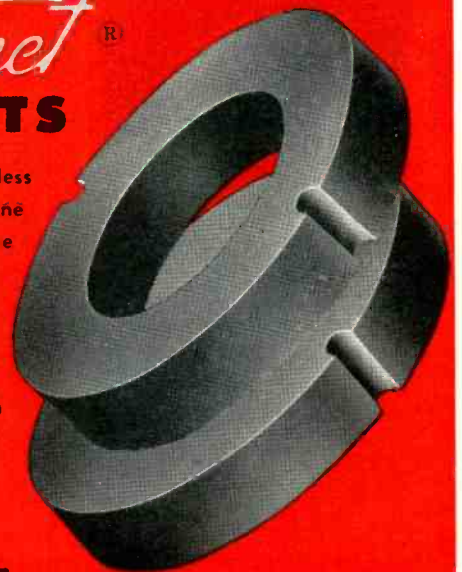

new D-B broad band precision cavity wavemeters



—solve 3 measuring problems

Fewer Instruments Needed. Each DEMORNAY-BONARDI instrument covers an unusually wide segment of the total range, and measures the entire frequency band within that range. Only eleven sizes serve from 2.6 KMC to 90 KMC. You save capital outlay on the number of sizes needed.

Extremely High Accuracy. These are high Q units, built with such precision that they may be used as secondary standards to calibrate all other laboratory cavities. Micrometer readings are plotted on a multi-page, high resolution calibration chart for maximum accuracy. DEMORNAY-BONARDI units are temperature compensated, and unaffected by changes in humidity or atmospheric pressure.

Sustained Accuracy. Sturdy, sealed construction, use of ball bearings, and inert gas pressurization assure permanence of calibration... Q values maintained for many years without service. Write for complete data.

SPECIFICATIONS

Temperature Range	-30°C. to +70°C.
Correction Factor	Temperature correction over range in the order of 10^{-6} /deg.C.
Temperature Compensation	Bi-metallic mechanism
Constant Dielectric	Nitrogen — not affected by environment
Hermetic Waveguide Seal	Metal — glass — mica window
Tuning Plunger Seal	Bellows type
Spurious Mode Suppression	Thru use of Microllon absorbing material
High Resolution Micrometer	Resolves plunger travel into 0.0001".

REACTION* TYPE CAVITY WAVEMETERS

Calibrated Freq. Band KMC	Calibration Accuracy Min ± MC	Cat. No.	Price
60-90	40	DBA-715-1	\$460
50-75	30	DBB-715-1	460
33-50	10	DBC-715-1	460
26.5-40	6	DBD-715-1	460
18-26.5	3	DBE-715-1	460
12.4-18	1.5	DBF-715-1	430
8.2-12.4	0.75	DBG-715-1	415
7.05-10	0.60	DBH-715-1	450
5.85-8.2	0.35	DBJ-715-1	485
3.95-5.85	0.15	DBK-715-1	530
2.6-3.95	0.075	DBL-715-1	735

*Note: Absorption and Transmission types also in stock
30-day deliveries on all sizes!



DEMORNAY-BONARDI • 780 SOUTH ARROYO PARKWAY, PASADENA, CALIFORNIA

WHEN SATELLITE SIGNALS EARTH...



Brush instrumentation can put the data in writing

Versatile Brush Recording Systems are ready for *tomorrow's* telemetering applications – and for your needs *today* in virtually all measurements. Here is why these instrumentation systems are preferred:

- They are the most flexible direct-writing recording systems available, providing you with a choice of ink and electric writing in the same units.
- They allow you to select the best chart speed for good signal repro-

duction and economy by providing the widest speed range available – 10" per day to 10" per second.

- You can change speed instantaneously from either local or remote locations. There is no interruption in recording because of the unique Brush electrically controlled chart drive.

In virtually any kind of measurements, you'll get the facts easier and faster with Brush equipment. Call your Brush representative or write for complete information.

Brush Recording Systems are used in telemetering and associated measurements by leading companies such as Boeing Airplane Company; Northrop Aircraft, Inc.; Convair; Cook Electric Co.; Republic Aviation Corp.

BRUSH ELECTRONICS COMPANY

INDUSTRIAL AND RESEARCH INSTRUMENTS
PIEZOELECTRIC MATERIALS • ACOUSTIC DEVICES
MAGNETIC RECORDING EQUIPMENT AND COMPONENTS



Division of
Clevite Corporation

LOOK TO BRUSH FOR YOUR MEASUREMENTS



ELECTRICAL



MECHANICAL



OPTICAL



THERMAL



ACOUSTICAL



NUCLEAR

NEW IDEAS IN MEASUREMENT FROM BRUSH



More and More Engineers are checking performance of equipment in the field thanks to new portable instruments by Brush. Here operating data is recorded from vibration pickups on a tractor and on a driver's back. Brush Portable Instruments are lightweight, easy to use and designed for rugged use. Ideal for recording stress, strain, force, vibration, torque, pressure, electrical variables and other physical characteristics.

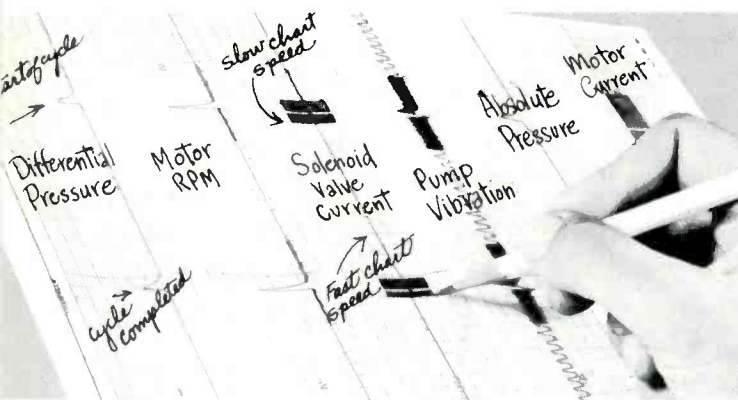

Gets more answers. Typical chart recording from a test on a pump system shows the wealth of information obtained by Brush Systems. Charts can be driven at many different speeds to obtain optimum clarity and economy. Chart drive is electrically controlled, thus speed can be changed instantaneously from local or remote locations.



Helps in "sound" design. Where sound or vibration is a problem you can obtain complete vital data with the new Brush Third-Octave Spectrum Recorder, coupled with either the measurement microphone or broad band accelerometer. This system provides a complete frequency and noise level analysis in third-octave bands from 35 cycles to 18,000 cycles per second and automatically plots entire analysis data.

BRUSH ELECTRONICS

INDUSTRIAL AND RESEARCH INSTRUMENTS
PIEZOELECTRIC MATERIALS • ACOUSTIC DEVICES
MAGNETIC RECORDING EQUIPMENT AND COMPONENTS



COMPANY

Division of
Clevite Corporation



Call BRUSH for the answer!

For help in your measurement problems, call your nearby Brush representative, or write Brush Electronics Company, Department 8,

3405 Perkins Avenue, Cleveland 14, Ohio.
Your request will receive prompt attention!

PROBLEM CHECK*

*Patent Pending

**new REEVES development
permits verification of problem
set-up before a problem is run**

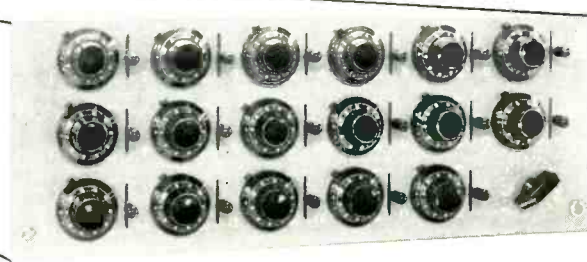
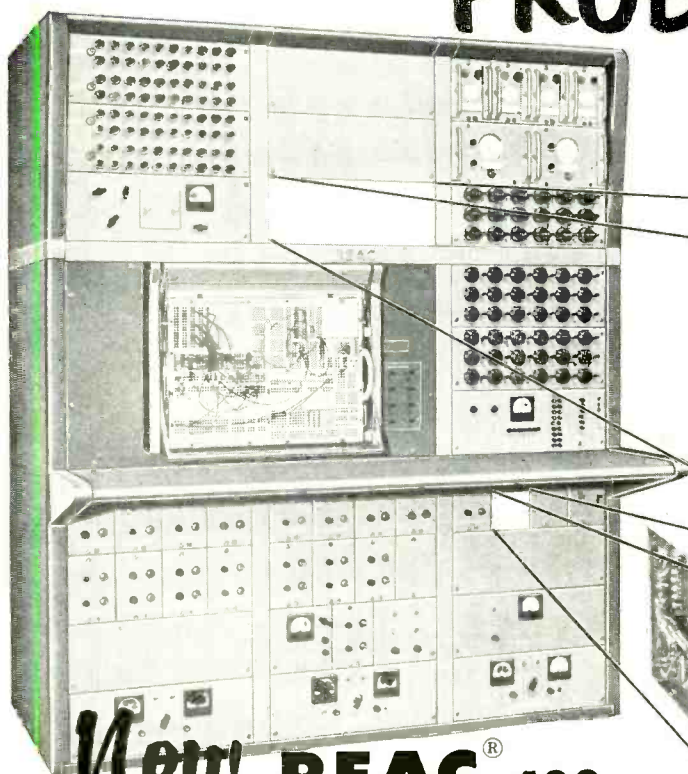

CHECKS:

- ★ Diagramming of the problem from the equation.
- ★ Patching of the problem from the diagram.
- ★ Operation of all computer components to be used.

New REAC[®] 400 ANALOG COMPUTER

**It's the only
economical way...**

Prepatch boards are, of course, prepared away from the machine. "Problem Check" means that only an absolute minimum of time is required on the machine to check the problem set-up in its entirety. A great deal of expensive checking and cross-checking while the problem is on the machine is thereby eliminated.

"Problem Check" is a new method developed by Reeves to verify analog computer circuits **without disturbing the problem set-up**. Checking is done directly from the equation **before** the problem is run, and the operation of every computing element is checked. Further, if the output of any computing element is not correct, the location of the difficulty is indicated, and the trouble can be quickly and easily found. After "Problem Check," runs may be taken on the machine with assurance that the set-up is correct and that the machine is functioning properly.

REVIEW THESE OUTSTANDING REAC[®] 400 FEATURES

New HIGH SPEED SERVOS

Servo multipliers have bandwidth over 50 cps. Velocity 1500 v/sec. Six gang pots; two tapped with front panel plug-in turrets for function generation.

New HIGH SPEED RESOLVERS

Vastly improved dynamic performance... 35-cycle bandwidth. Rectangular and Polar operation; Full AGC either mode requires no trimming. Front panel plug-in turrets for function generation.

New BUILDING-BLOCK CONSTRUCTION

Permits assembly of computer elements in any desired combination to do particular job or expand existing installation. Completely adaptable to your specific requirements.

New CONVENIENT PATCHBAY

Available in units of 1632, 3264 or 4896 holes for maximum flexibility. Color-coded mask aids in patching. Patch-board changes possible during operation.

New POWERFUL AMPLIFIERS

New dual amplifier chassis, individually chopper-stabilized. Noise less than 3 mv rms in cabinet. Phase shift 0.075° @ 100 cps. in cabinet. Bandwidth over 10 KC in cabinet.



REEVES INSTRUMENT CORPORATION

A Subsidiary of Dynamics Corporation of America
201 East 91st St., New York 28, N. Y.

REAC
Analog
Computers



Precision
Floated
GYROS



Precision
RESOLVERS and
PHASE SHIFTERS



SERVO
MECHANICAL
PARTS



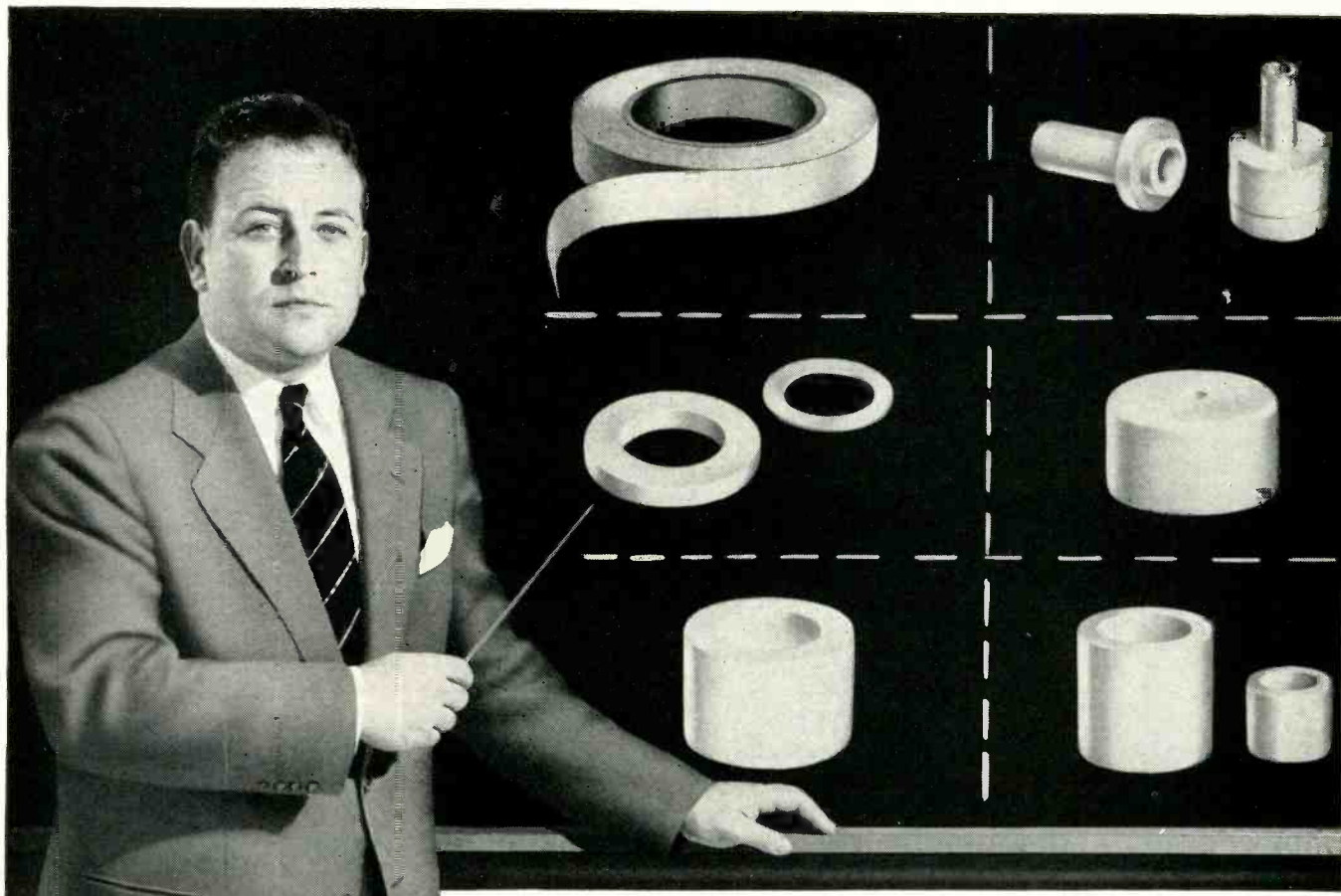

TRY **R/M** Teflon*

BEFORE YOU SAY "IMPOSSIBLE!"

R/M "TEFLON" is blazing many trails that few people thought would ever open up. Daily it is instrumental in improving old products and processes, in developing new ones, and in effecting unheard-of economies. In the form of tape and other component parts, R/M "TEFLON" has already licked many electrical and electronics problems once thought unsolvable. So turn to R/M if you have a problem that "TEFLON" might possibly solve. We can fabricate to your specifications or supply you with "TEFLON" in the form of rods, sheets, tubes or tape. For complete information, write today.

PROPERTIES OF "TEFLON"

High dielectric strength • Moisture absorption zero • Unaffected by weather • Excellent heat stability up to 500°F. in continuous operation • As tape, leaves no carbon residue along discharge path • High impact resistance • Nonadhesive • Stretches easily • Tensile strength 1500-2500 psi

**Du Pont's trade-mark for its tetrafluoroethylene resin*



RAYBESTOS-MANHATTAN, INC.
ASBESTOS TEXTILE DIVISION, Manheim, Pa.

FACTORIES: Manheim, Pa. • Bridgeport, Conn. • No. Charleston, S.C. • Passaic, N.J. • Neenah, Wis. • Crawfordsville, Ind. • Peterborough, Ontario, Canada

RAYBESTOS-MANHATTAN, INC. Asbestos Textiles • Packings • Brake Linings • Brake Blocks • Clutch Facings • Fan Belts • Radiator Hose • Rubber Covered Equipment • Industrial Rubber, Engineered Plastic, and Sintered Metal Products • Abrasive and Diamond Wheels • Bowling Balls

NATVAR 400 means this Stator is SET FOR *LONG* LIFE



Fairbanks-Morse has been building high dependability power generating equipment for 50 years. They have safeguarded the "name worth remembering" by sound engineering and workmanship, and careful selection of materials.

To insulate and protect stator coils of alternators, Fairbanks-Morse uses "Natvar 400" extruded tape because of its consistently good electrical and physical properties, and resistance to high temperatures.

If reliability is important to you, it will pay you to use Natvar flexible insulations. They are dependably uniform no matter when or where purchased, and are immediately available either from your wholesaler's stock or direct from our own.



Natvar Products

- Varnished cambric—cloth and tape
- Varnished canvas and duck
- Varnished silk and special rayon
- Varnished—Silicone coated Fiberglas
- Varnished papers—rope and kraft
- Slot cell combinations, Aboglas®
- Vinyl coated—varnished—lacquered tubing and sleeving
- Extruded vinyl tubing and tape
- Styroflex® flexible polystyrene tape
- Extruded identification markers

Ask for Catalog No. 423



Stator showing open slot construction of the Fairbanks-Morse Type TGZO Alternator, 1405 kva — 300 r.p.m. — 3 phase — 60 cycle — 2400/4160 volts — 80% p.f. — for direct connection to a diesel or dual-fuel engine, for utility, municipal and industrial power generation. Since they are frequently subjected to prolonged overloads in this type of service, they are designed for 50°C temperature rise above 40°C ambient. Coils, insulated and protected with "Natvar 400" extruded tape are tested at 9520 volts for one minute.



Two form wound coils for a Fairbanks-Morse 4160 volt Alternator. Lower coil has end sections insulated with "Natvar 400" extruded tape. Slot section is wound with a sacrifice tape, which is later removed and entire coil is wound with linen tape. Upper view of coil shows completed form, after final varnish dip and bake, ready for insertion in stator.

NATVAR CORPORATION

FORMERLY THE NATIONAL VARNISHED PRODUCTS CORPORATION

TELEPHONE

RAHWAY 7-8800

CABLE ADDRESS

NATVAR: RAHWAY, N. J.

201 RANDOLPH AVENUE • WOODBRIDGE, NEW JERSEY

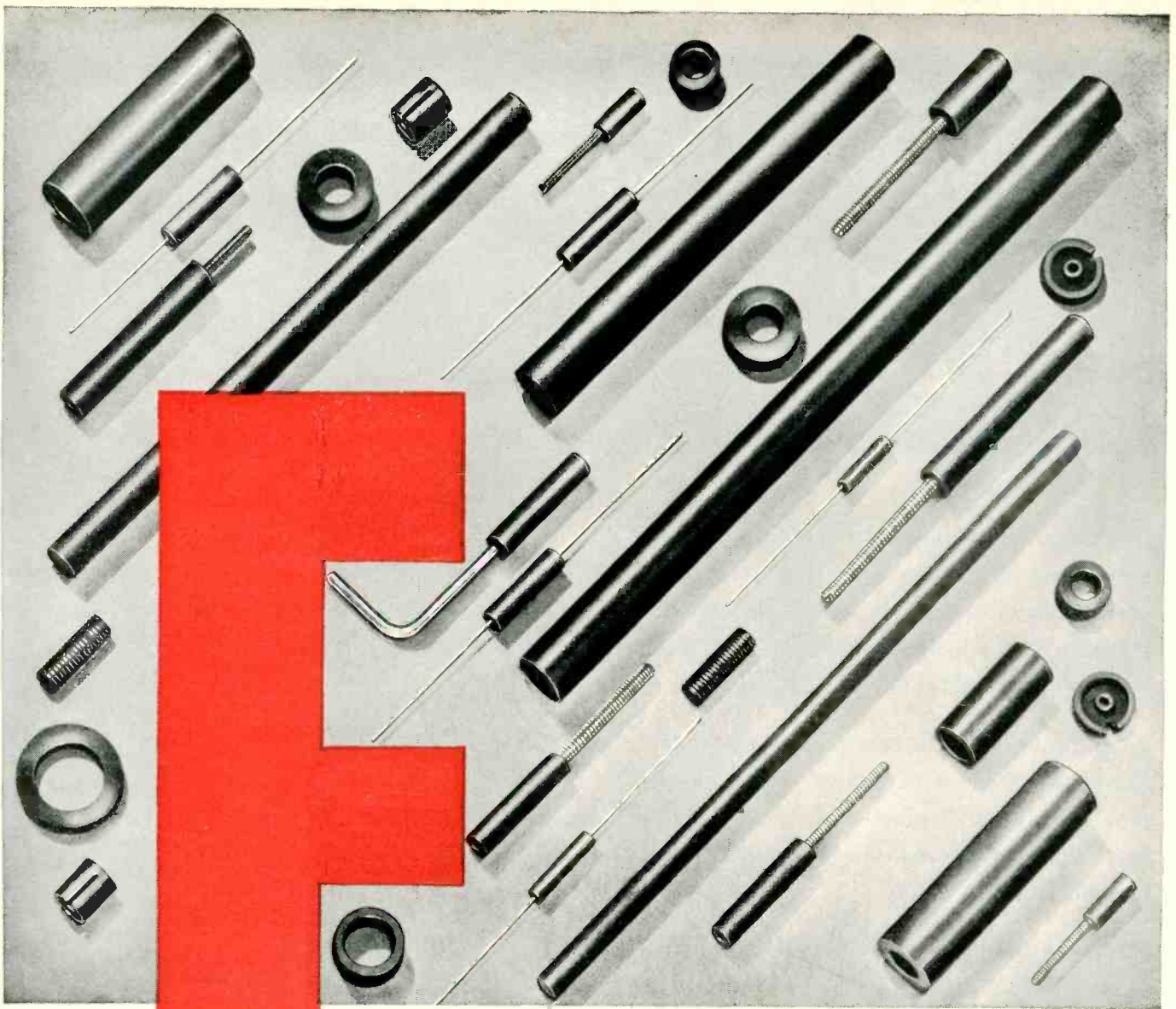

FERRITES

by Moldite ...

Whatever you need in Ferrites

- Antenna Rods Sleeves
- Toroids Threaded Cores
- Cups Coil Forms
- Cores

There is a MOLDITE quality engineered product perfect for your application.

also Magnetic Iron Cores
Molded Coil Forms
(iron & phenolic)

Send for our catalog NM No. 110

... and backed by MOLDITE'S reputation for highest quality and guaranteed uniformity from first to last.

The use of a MOLDITE ferricore properly designed into a specific coil has the following advantages.



- Lower losses (eddy current)
- Smaller sizes for more compact construction
- Higher efficiency
- Higher permeability
- Lower operating temperatures
- Less corona effect
- Lighter weight
- Lower cost

1410 CHESTNUT AVE., HILLSIDE 5, N. J.

Robert T. Murray Co. Jerry Golten Co. William A. Franklin
604 Central Avenue 2750 W. North Ave. 3 Holly Road
East Orange, N. J. Chicago 22, Ill. North Syracuse, N. Y.

Perlmuth-Colman & Assoc. Jose Luis Ponte John S. Plewes Co.
2419 South Grand Ave. Cardoba 1472 52 Humbercrest Blvd.
Los Angeles Cal. Buenos Aires Toronto 9. Ontario

Automation Creates Jobs For Workers With Skills

There is new and reassuring information for those who fear that "automation" — the control of machines by machines — will mean fewer job opportunities. It comes from a special survey of 1,574 companies in metalworking industries recently completed by *AMERICAN MACHINIST*, a McGraw-Hill publication. More than one-fifth of the companies reported that they already have automatic loading, transfer or assembly machinery in operation. In these companies as a whole there has been a net increase in total employment since this machinery was installed.

According to the *AMERICAN MACHINIST* survey, of these companies with actual experience in automation

26% reported increases in employment averaging 21%

51% reported no change in total employment

23% reported decreases in employment averaging 16%

More Jobs for the Skilled

Of greater significance, however, is the response by 40% of these companies that they required more skilled maintenance men and by 21% of the companies that they had increased their engineering staffs. This indicates that automation is strengthening a trend already evident in the United States, a trend of expanding opportunity for those with industrial and professional skills and, relatively, of contracting opportunity for the unskilled.

The following chart shows how strong this trend has been over the past 25 years and how strong it may be expected to be over the next 15 years.

There has been a sharp decline in the percentage of unskilled workers in the nation's labor force and a corresponding increase in the percentage of those with varying degrees of skill.

Increasing occupations

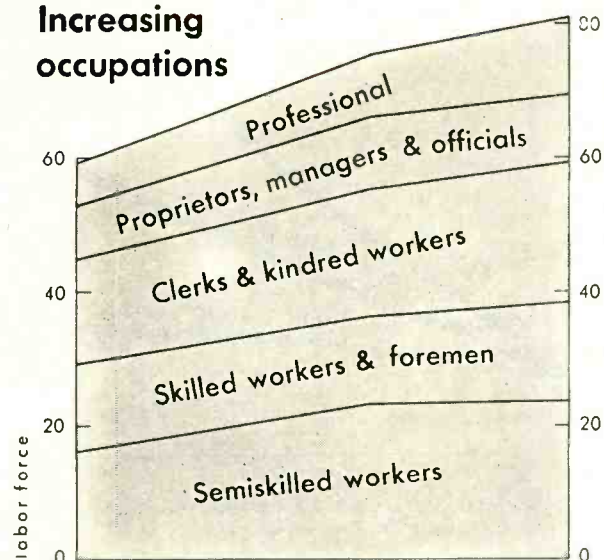

Decreasing occupations

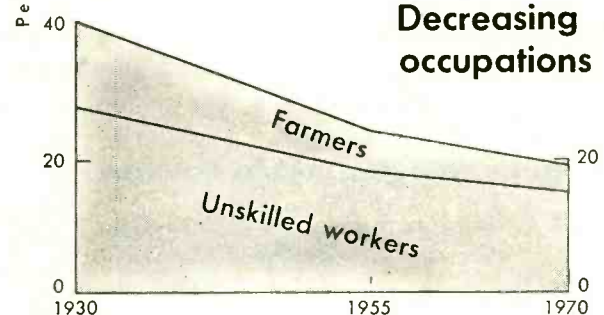

It is possible, of course, to cite cases of individuals and groups that do not conform to the charted trends. Farmers, for example, are becoming at the same time more skilled and less numerous. But this does not upset the broad proposition that opportunities are increasing for those who have skills.

Power and Production

Much of the basic explanation for the relative expansion of opportunities for those with industrial and professional skills lies in the increasing use of power-driven machinery. This has made possible a vastly greater increase in manufacturing production than in the manhours of human labor devoted to it. The following chart shows the relative increases in electrical energy and manhours of labor used in manufacturing since 1930 and the rise in industrial production.

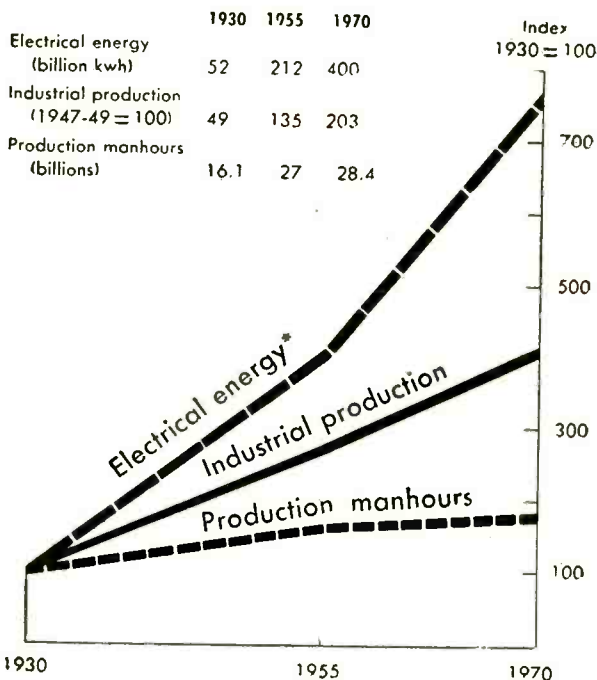

*Excludes power used in aluminum and magnesium reduction, both very heavy power users.

Power-driven machines have reduced the amount of human energy required for physical labor, but they have increased the need for skillful handling and maintenance. As the AMERICAN MACHINIST survey demonstrates, the same is true of automatically controlled machinery.

Higher Wages, More Leisure

The rising average wage of American industrial workers and the decline in hours per week that they must work reflect directly the extent to which the increase in industrial production has outstripped the manhours devoted to it. The final chart shows the increase in weekly wages (in dollars of constant purchasing power) and the decrease in the average workweek in manufacturing since 1930. It also shows the changes that may come in the next 15 years if present trends continue.

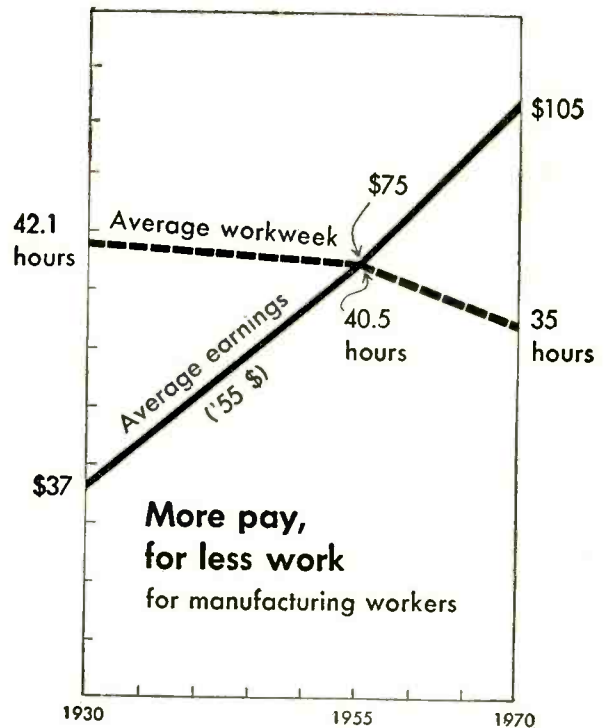

There are some who would slow what an earlier editorial in this series characterized as "the continuing process of taking dull and laborious work off the backs and minds of men and transferring it to machines operating in large batteries under automatic control." In doing so, they might make the world safer for those with no skill. The far more constructive course is to welcome the expanding opportunities now being provided and be sure that the nation's young people, who are now starting another school year, are prepared to take advantage of them.

This message is one of a series prepared by the McGraw-Hill Department of Economics to help increase public knowledge and understanding of important nationwide developments that are of particular concern to the business and professional community served by our industrial and technical publications.

Permission is freely extended to newspapers, groups or individuals to quote or reprint all or parts of the text.

Donald C. McGraw
PRESIDENT

McGraw-Hill Publishing Company, Inc.

Now... SEALED DEPENDABILITY IN AN EXCLUSIVE DOUBLE-POLE SWITCH

New



HERMETICALLY-SEALED DOUBLE-POLE SWITCH

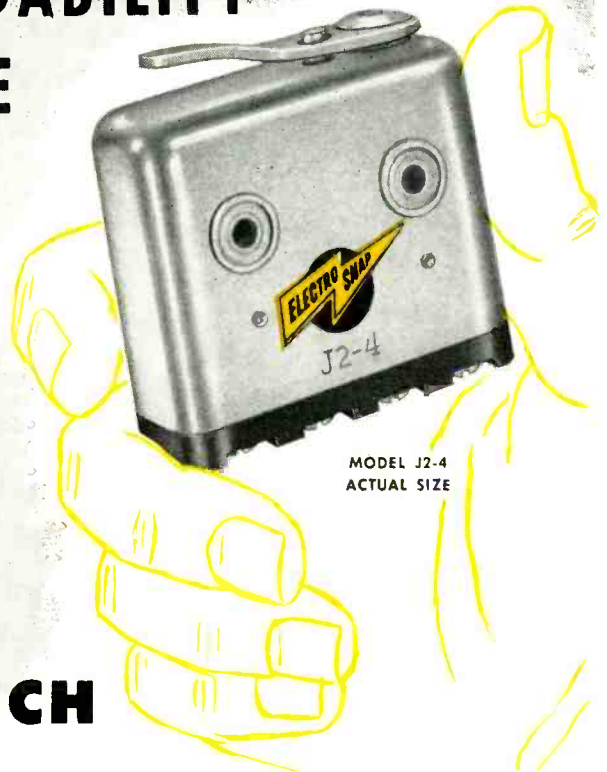

MODEL J2-4
ACTUAL SIZE

Seals Out Moisture, Dirt, Oil, Corrosion, Condensation from Temperature Cycling

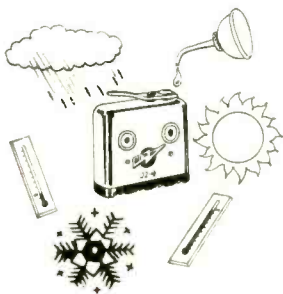

With switch mechanism hermetically-sealed in a dry, inert gas, switch is dependable at any altitude, moisture or temperature condition. Use it on aircraft, machines where oil is a problem, in areas subject to freezing or extreme heat or corrosive atmospheres.

Controls FOUR Circuits with ONE Snap

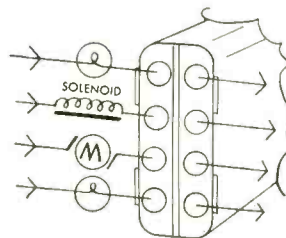

Eight separate contacts and terminals permit many unusual circuit combinations. May be wired externally for D.P.D.T., 2 circuit; D.P.-S.T., normally open; D.P.S.T., normally closed. Movable poles may also be wired externally in series to increase current capacity of switch or number of contact breaks for high voltage switching.

Eliminates Expensive and Bulky Relays, Extra Switches

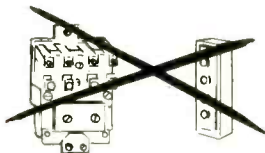

J2-4 can control circuit combinations that were formerly possible only with complicated relays or a number of separate switches. Saves money, weight and space.

Starts, Stops or Reverses Three-Phase Motors

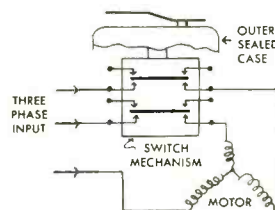

Simultaneous action of two movable poles permits switch to break or reverse current flow through two windings of a three-phase motor. Movable poles are interlocked by unique design of switching mechanism, eliminating need of adjustment.

SPECIFICATIONS



Electrical Rating—10 amps @ 125/250v AC/ 30v DC Ind.
Operating Force—2½ lbs.
Weight—2½ oz. (4 oz. with actuator)

TOGGLE ACTUATOR
(constant or momentary contact) can be furnished on switch. Fits AN-type toggle switch mountings.

WRITE FOR CATALOG DETAILS

ELECTRO-SNAP SWITCH & MFG. COMPANY
Attention HJN-11 • 4220 Lake Street, Chicago 24



Please send full information on new J2-4 Hermetically-Sealed Simultaneous Double-Pole Switch.

Name.....
Company.....
Street.....
City..... Zone..... State.....

ITEMS LIKE THESE AVAILABLE AT

Chase[®]
WAREHOUSES!

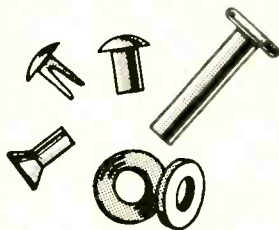

BRASS or COPPER
RIVETS and WASHERS



BRASS, COPPER, BRONZE
COTTER PINS

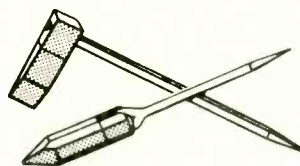

SOLDERING COPPERS

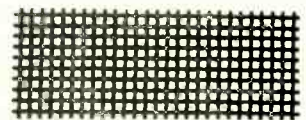

INDUSTRIAL WIRE CLOTH

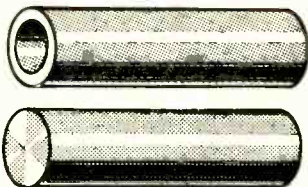

SOLID or CORED BEARING BRONZE



BRASS or BRONZE WOOD
and MACHINE SCREWS

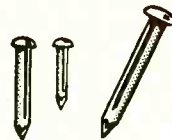

BRASS ESCUTCHEON PINS

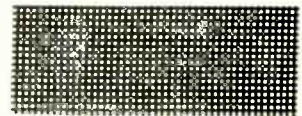

BRASS STRAINER CLOTH

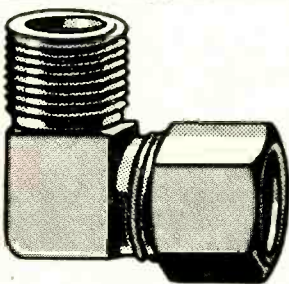

INDUSTRIAL and
AUTOMOTIVE FITTINGS

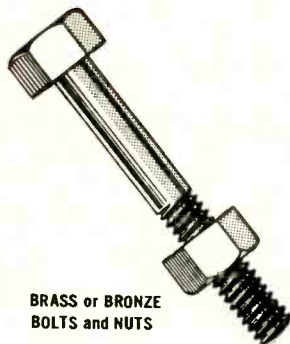

BRASS or BRONZE
BOLTS and NUTS

CALL US FOR ANYTHING from Bearing Bronze Bars to Brass or Bronze Bolts... or other fastenings like those shown here for maintenance, repair, operating or production. Twenty-five Chase warehouses are located in major industrial centers from coast to coast. Phone the one nearest you. We can usually fill your orders from stock.

NEW! Chase's informative rod and wire movie: "IN THE CHIPS." Arrange for a free loan of this film by contacting the Chase warehouse or sales office near you. Write on your company letterhead, today!

Chase [®]

BRASS & COPPER CO.

WATERBURY 20, CONNECTICUT • SUBSIDIARY OF KENNECOTT COPPER CORPORATION

The Nation's Headquarters for Brass & Copper

Atlanta Baltimore Boston Charlotte Chicago Cincinnati Cleveland Dallas Denver Detroit Grand Rapids Houston Indianapolis Kansas City, Mo. Los Angeles Milwaukee Minneapolis Newark New Orleans New York Philadelphia Pittsburgh Providence Rochester St. Louis San Francisco Seattle Waterbury (sales office only)

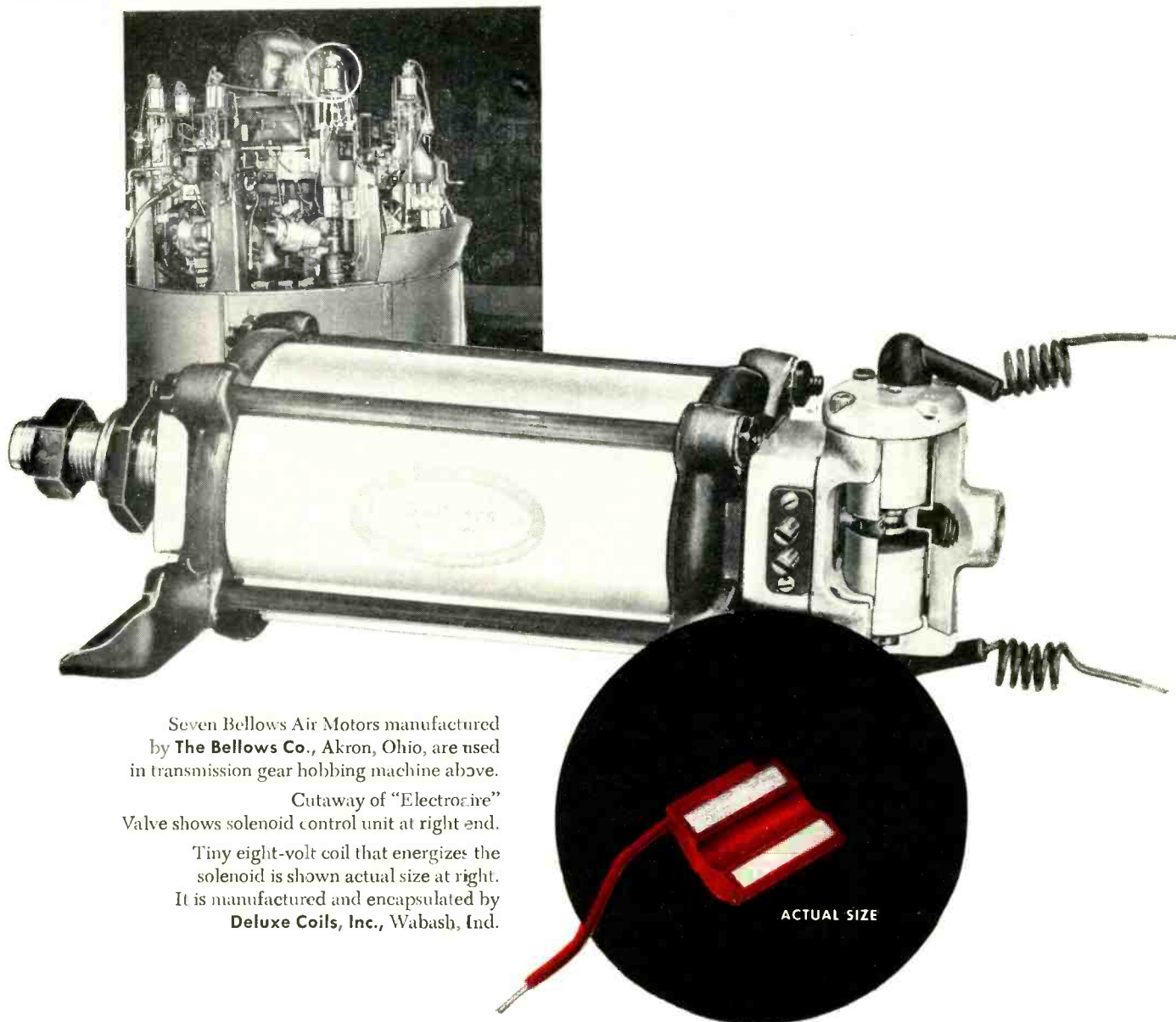

Seven Bellows Air Motors manufactured by **The Bellows Co.**, Akron, Ohio, are used in transmission gear hobbing machine above.

Cutaway of "Electroaire" Valve shows solenoid control unit at right end.

Tiny eight-volt coil that energizes the solenoid is shown actual size at right. It is manufactured and encapsulated by **Deluxe Coils, Inc.**, Wabash, Ind.

Solenoid coils encased in **BAKELITE** Epoxy Resin rack up 50,000,000 cycle service record!

Heart of this Bellows Air Motor is a unique 4-way directional valve which is air-powered but electrically controlled. Two built-in solenoid control units act as "triggers" to release and direct the air pressure.

Completely enclosing and sealing these solenoid coils in **BAKELITE** Brand Epoxy Resin makes them durable and trouble-free. The manufacturer guarantees them against burnout, states that operating records of 50,000,000 cycles or more without

maintenance are quite common!

BAKELITE Epoxy Resins—available in many different types—are widely used for potting and encapsulating. They resist moisture, oils, grease, chemicals, and most acids and alkalis. Easily poured as a liquid, they cure at room or moderately elevated temperatures. Their dielectric and adhesive properties are excellent. For more specific information and a list of suppliers, write today to Department KN-50.



BAKELITE COMPANY, A Division of Union Carbide and Carbon Corporation ☐☐☐ 30 East 42nd Street, New York 17, N. Y.
The term **BAKELITE** and the Trefoil Symbol are registered trade-marks of UCC

show us
YOUR
part....

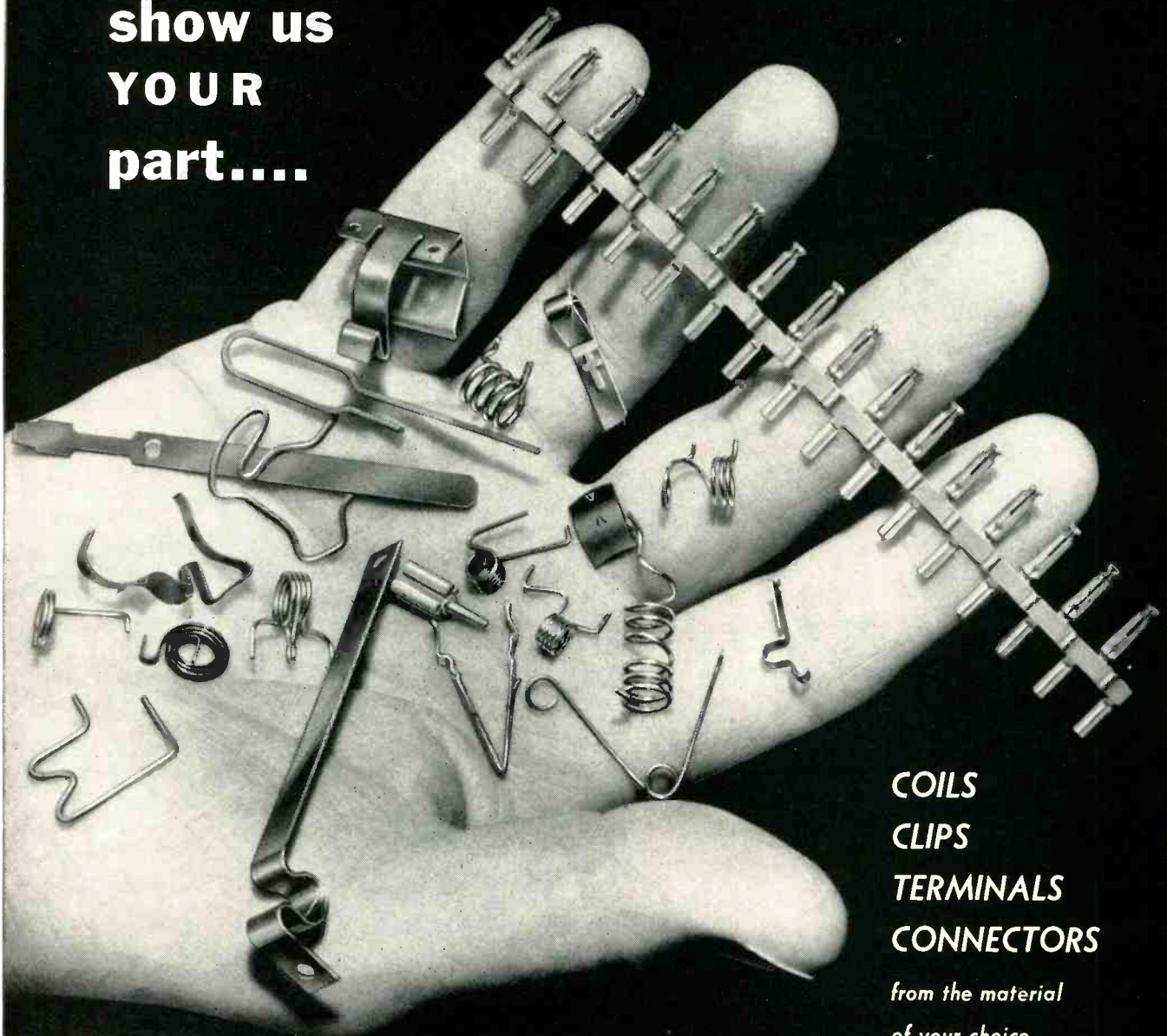

**COILS
CLIPS
TERMINALS
CONNECTORS**

*from the material
of your choice*

and, of course, all types of springs—our specialty for nearly 100 years

**Millions of items can be made to your advantage
by our Springmaking methods and materials**

***Wallace Barnes* COMPANY**
DIVISION OF ASSOCIATED SPRING CORPORATION
BRISTOL, CONNECTICUT

FOR SPATIAL REFERENCE

Gyros

BY



Greenleaf

QUALITY ABOVE ALL!

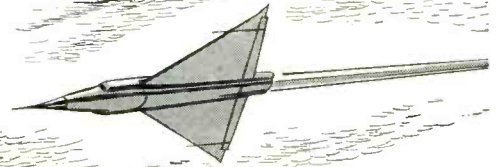

HIG-4 GYRO

DATA

1. Spin Motor: 12 Volts A.C., 400 cps, 2 phase
2. Power Required: Running 1.5 Watts—Start 2.2 Watts
3. Run-up Time: 15 Seconds Maximum
4. Angular Momentum: 10^4 Gram-Centimeter²/second
5. Gimbal Travel: $\pm 5^\circ$ Maximum
6. Signal Generator Sensitivity: 10 mv/mr, with 55 m/a, 400 cps
7. Signal Generator Linearity Deviation: $\pm 1\%$
8. Torque Generator Linearity Deviation: Less than 1%
9. Input Rate: 4 Radians/second Maximum
10. Drift Rate: 1° per hour maximum
11. Weight: 1.5 pounds

NOTE: This Gyro can be readily modified to meet your requirements. We invite inquiries listing specifications.

The Greenleaf Line of Gyros and associated devices is being steadily expanded. It now includes a wide selection of Free and Rate Gyros, and the HIG-3 and HIG-4 Gyros.

Write, wire or phone for further information.

ENGINEERING • DEVELOPMENT • PRODUCTION

THE



Greenleaf MANUFACTURING COMPANY

7814 W. Maplewood Industrial Court • Saint Louis 17, Missouri

Producers of the HIG-3 and HIG-4 Gyros, Rate and Free Gyros, Differential Pressure Mach Meters, Air Speed Indicators, Computers, Switches and many other precision-built components.

At Greenleaf Plant No. 2 facilities are available for precision castings.

NOW

**Radio Industries can give you
even better coils at lower cost**

using **NEW RI-Ion**
one-piece coil forms
(patents pending)

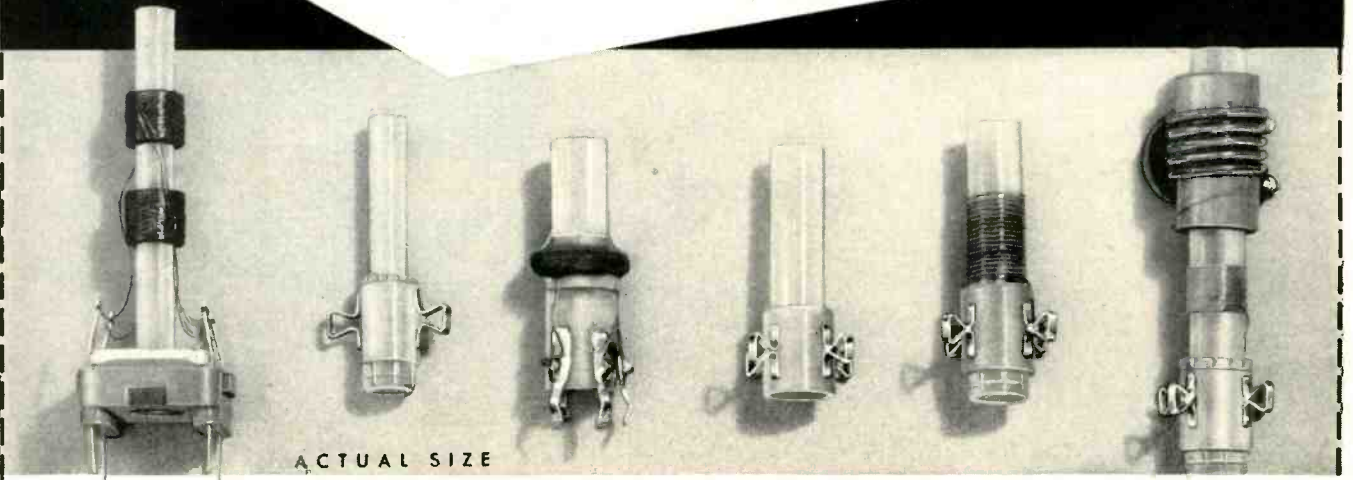

LOW COST because they are ONE-PIECE precision molded forms of high temperature plastic, eliminating the usual high cost assembly operations in conventional phenolic forms. No mounting clips are required with RI-Ion SNAP-IN keyed design! (Interchangeable with present clip-mounting methods.)

PLUS these superior electrical and mechanical features!

1. Resists electrolysis indefinitely.
2. Has uniform mechanical characteristics.
3. Simplifies components for automatic insertion in printed circuit-type applications.

AVAILABLE for conventional or printed circuit lug-type applications in countless R.F. applications, including all varieties of RI-trans. (RI-trans are available in 8-32 or ¼-28 RI-Ion tube construction.) RI-Ion forms are available in a wide variety of colors for easy identification.

WE WELCOME YOUR INQUIRIES
*send us your electrical and
mechanical specifications*



RADIO INDUSTRIES, INC.
5225 no. ravenwood avenue • chicago 40, illinois

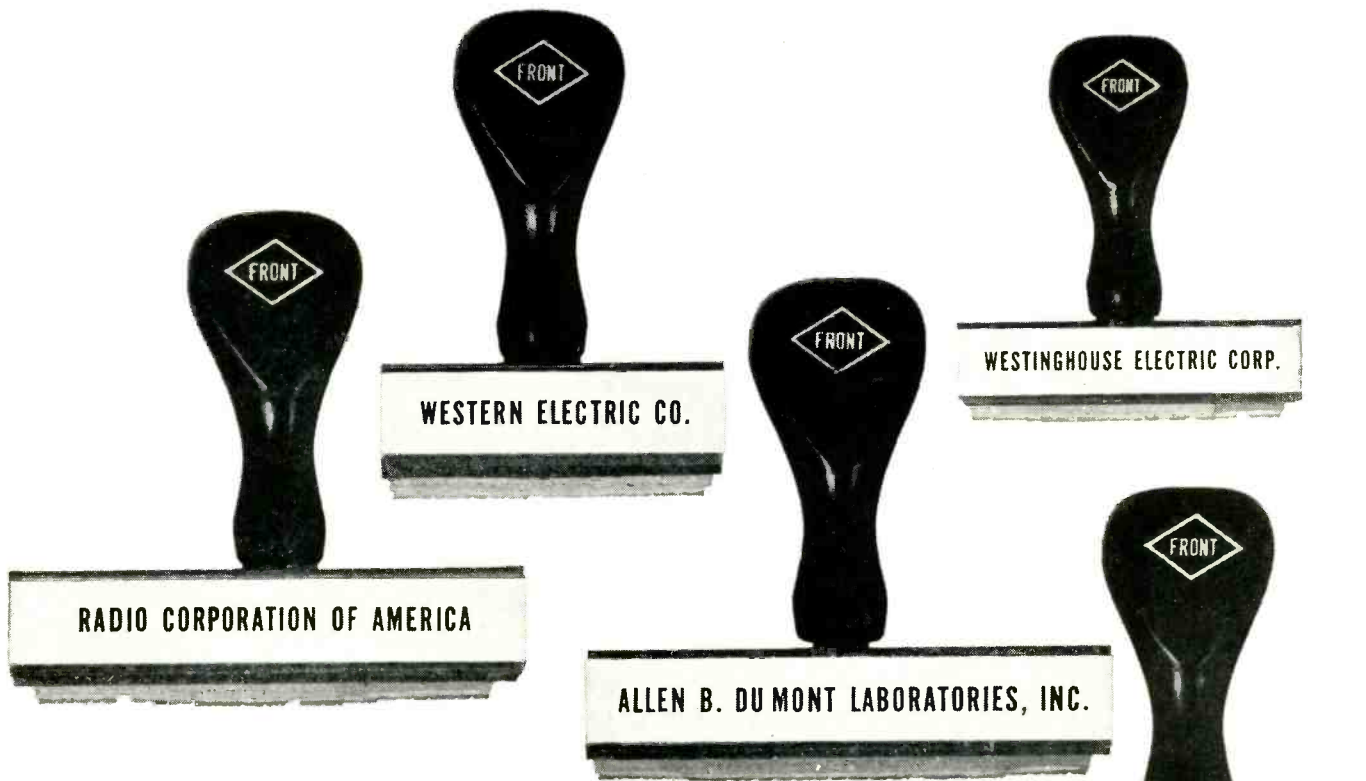

These Stamps of Approval...

...were photographed in the Volkert shipping department. They are used in the last of a chain of operations that each day sends more than two million precision parts to these and other* top electronics manufacturers.

While proud of its position as the industry's leading independent supplier of precision stampings, Volkert accepts the responsibility to provide improved metal components for the new electronic products now on the horizon.

If you want to know more about electronic stampings, here are two suggestions:

1. Arrange for a group showing in your plant of the color film, *Stampings for Electronics*.
2. Ask to be placed on the mailing list to receive *The Volkert View*.

* Only a few of the firms Volkert serves can be shown here.



Volkert Stampings, Inc.
222-34 96th Avenue
Queens Village 29, L. I., N. Y.

for Electronic Stampings by

Volkert

SOLVING TOMORROW'S PROBLEMS



Getting information the hard way!

Finding out what's going on inside an atomic mushroom is not a job for amateurs.

In some tests, a pilotless, ground-controlled U. S. Air Force drone plane has been the investigator that entered the radio-active cloud and took a reading—then returned to base where instruments were read for the vital story they had to tell . . . electronic instruments developed and produced, in part, by Webster-Chicago.

This is another example of how Webster-Chicago's Government Division serves the Services. For research, development and production that solve tomorrow's problems today, our engineers and facilities are at your call.

... from an idea to a prototype
... from a prototype to production

WEBSTER-CHICAGO

Government Division • 816 N. Kedzie, Chicago
Makers of Webcor Products since 1914

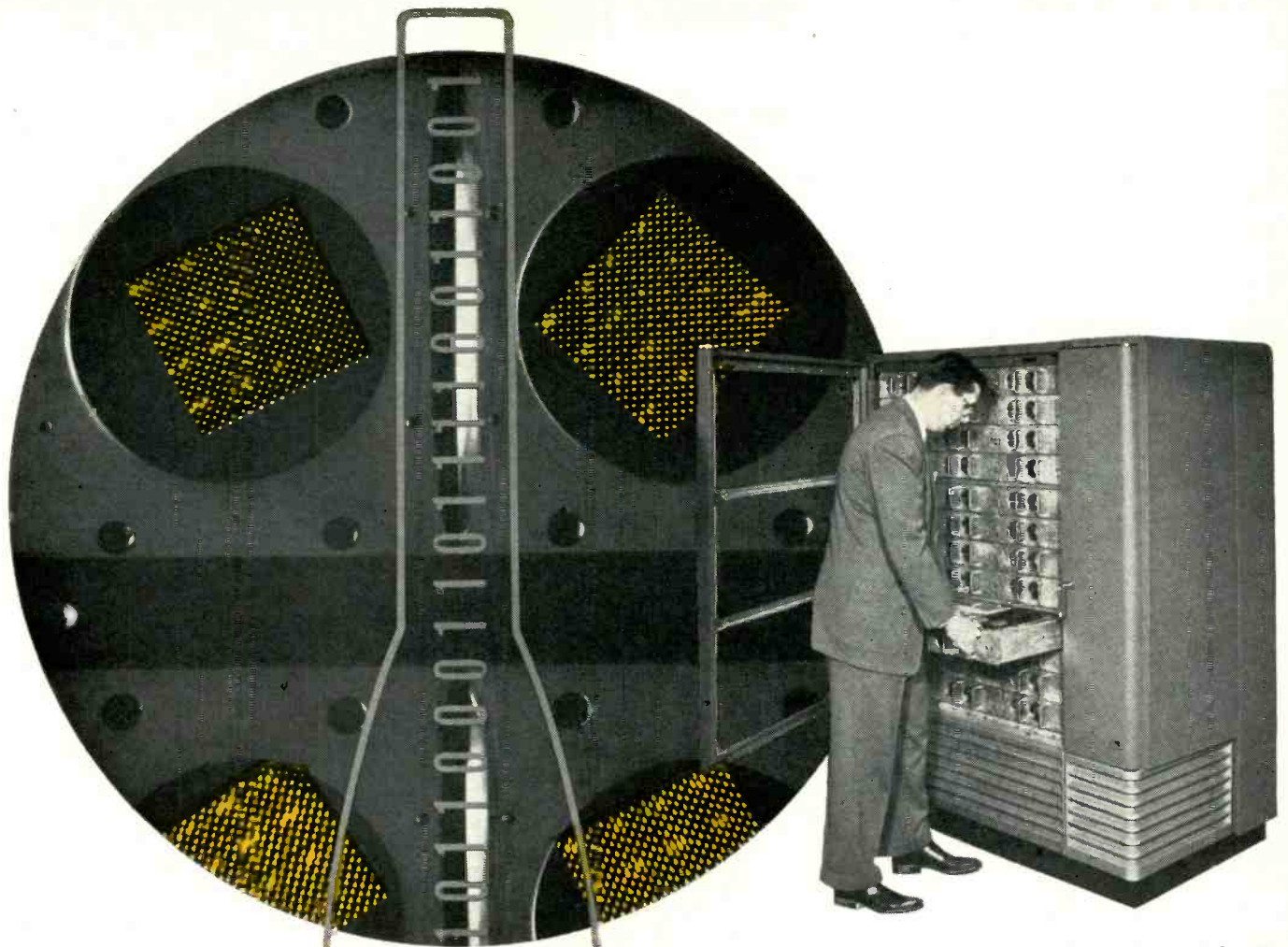

*you can't risk wiring
trouble in an electronic*
brain

Out goes your favorite reading lamp, leaving you mumbling in annoyance—even so, it's hardly a calamity. But in the International Business Machines Corporation's incredible electronic calculator, the "701," wiring trouble is simply out of the question. It cannot be allowed to happen.

One of the "701's" three "memory" devices is the Electrostatic Storage Unit. All information to and from other components of this powerful electronic "brain" passes through the Electrostatic Storage Unit which stores data or releases it in 12/1,000,000 of a second.

Obviously, this kind of performance demands consistently dependable performance from *all* machine elements.

For users of hook-up wire there is, then, significance in the fact that Rome Synthinol® Hook-up Wire is used in wiring the power supply for this electrostatic storage unit. Rome Synthinol's characteristics of high resistance to heat, flame, acids, oils, plus consistent quality control during production, are what make it dependable.

It will pay you to investigate the advantages of this quality Hook-up Wire, Rome Synthinol.

The banks of cathode ray tubes in the IBM Electronic Data Processing Machines are known as Electrostatic Storage Units, one of three "memory" devices.

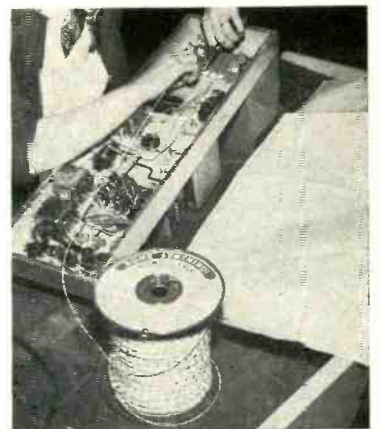

Rome Synthinol Hook-up Wire is used in wiring the power supply for the IBM Electrostatic Storage Unit. The unit shown here is part of the deflection gate and supplies the necessary voltage to it.

It Costs Less to Buy the Best



ROME CABLE
Corporation
ROME - NEW YORK
and
TORRANCE - CALIFORNIA

KOCH ... World's largest fabricator of moulded Fiberglas products

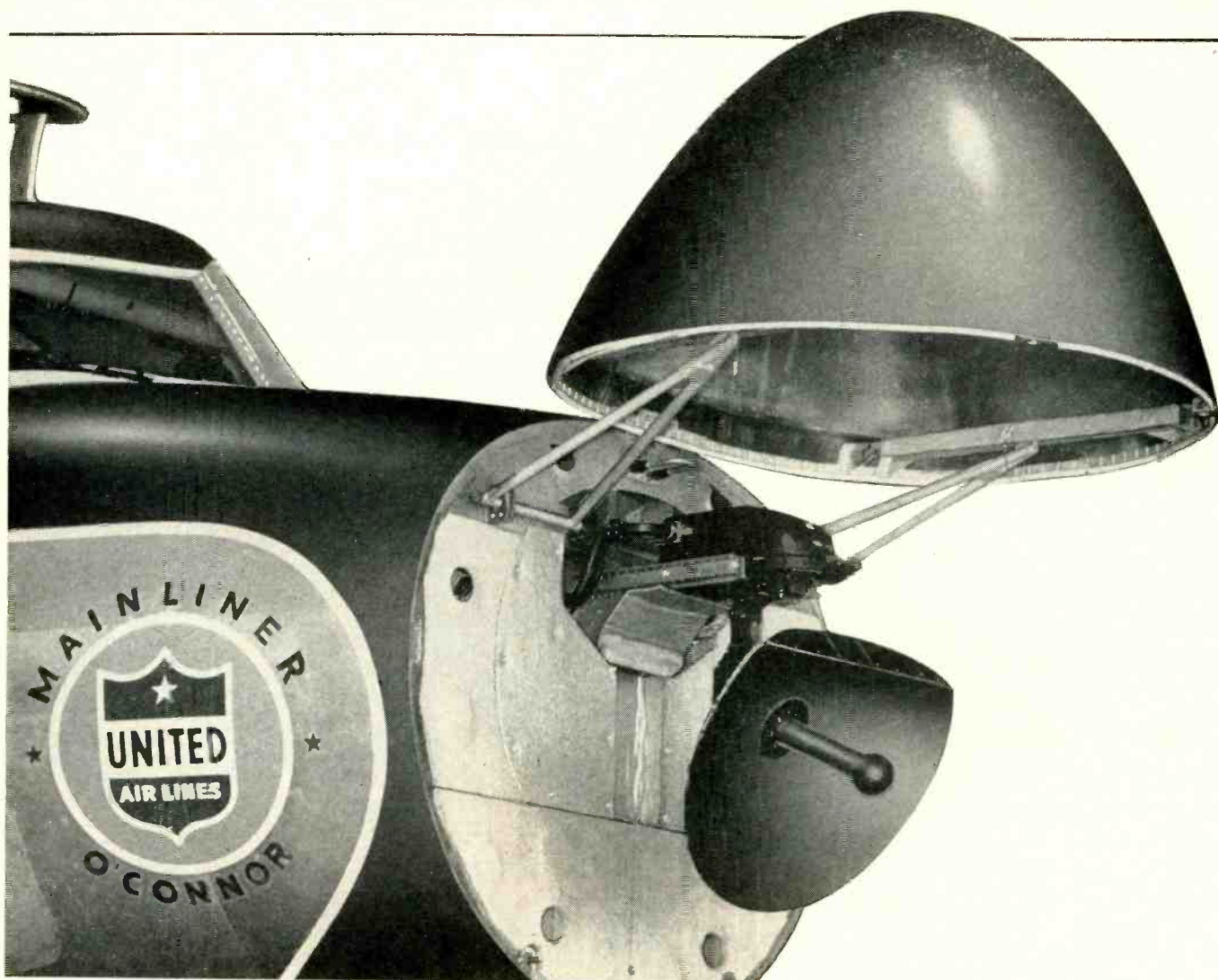

How Convair 340's Solve a Housing Problem for United Air Lines' All-Weather Radar



The nose knows when and where bad flight weather threatens! Radar weather-spotting equipment in the nose of United's Convair 340 now sees through a Koch Fiberglas Radome.

When Convair received United's order for radar-equipped 340's, they naturally turned to Koch, world's largest fabricator of moulded Fiberglas, for domes to house the radar.

The life expectancy of the Koch Radome is many, many times that of any other Radome. This Radome is made possible only by Koch's own exclusive method of moulding.

W. J. Flanagan, Convair Purchasing Agent, wrote Koch upon completion, "You have made

substantial contributions to this industry by proposing and successfully applying new departures and moulding technique."

If you are a plane manufacturer, or if you install airborne radar, investigate Koch's Moulded Fiberglas Radome. If you manufacture any equipment that needs special protection, ask the people who know the most about Fiberglas fabrication. We will be glad to confer with you about your project. Address Dept. EKD.



KOCH *Fiberglas*
PRONOUNCED "KOKÉ"

Pioneer in industrial products of moulded Fiberglas

CORTE MADERA, CALIFORNIA

Is this versatile

new CBS tube

the answer to

your

HIGH-VOLTAGE

CONTROL problems?



The 6792 is a CBS-Hytron advanced-engineering accomplishment that can solve high-voltage control problems in:

- Nucleonics
- Photronics
- Radar
- Industrial Electronics
- Computers
- Color TV
- or Research.

Here is the first multipurpose, high-voltage control tube rated for operation from 3 to 25 kilovolts. An outgrowth of CBS-Hytron's long experience in designing transmitting and pulse tubes, this new tetrode will perform as a:

- h-v regulator**
- h-v gating tube**
- h-v variable resistor**
- or h-v amplifier**

Note the wide range of input connections to vary the operating characteristics

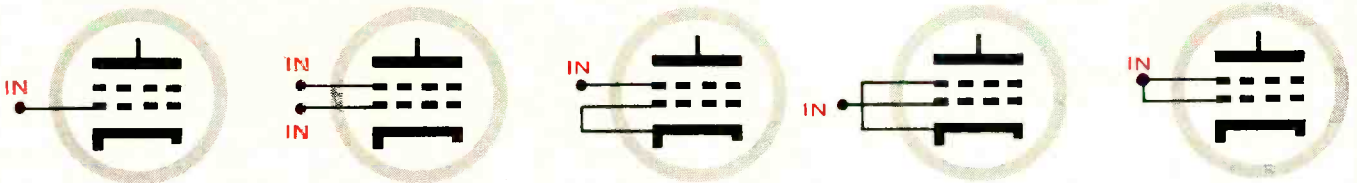

The versatile CBS 6792 may well be the answer to *your* high-voltage control problem. Check it. Write for data sheet E-258.



Quality products through *ADVANCED-ENGINEERING*

CBS-HYTRON, Danvers, Massachusetts . . . A DIVISION OF COLUMBIA BROADCASTING SYSTEM, INC.

PHELPS DODGE **DAGLAS***

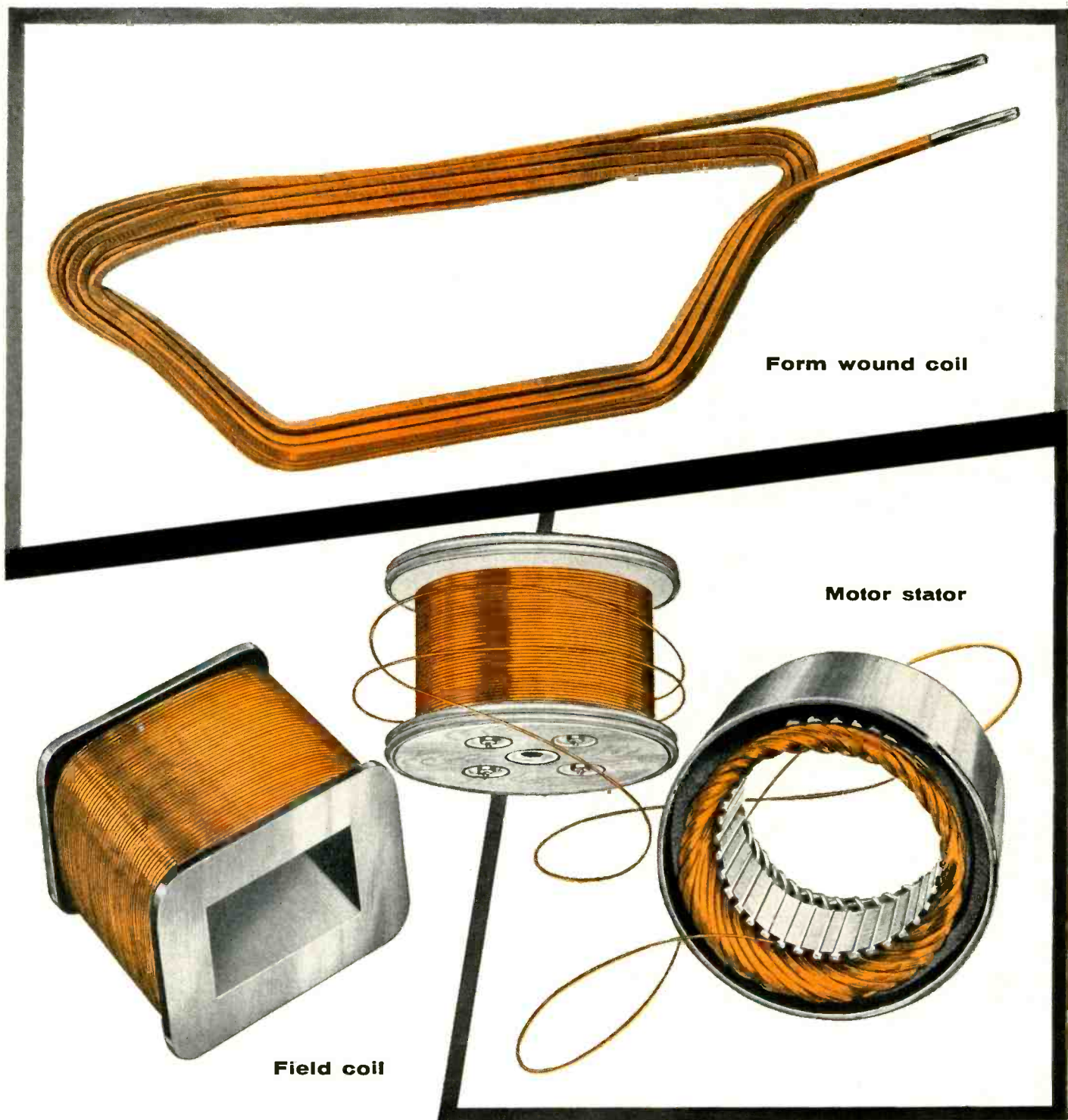

Form wound coil

Motor stator

Field coil

First for Lasting Quality—from Mine to Market!

*Reg. U.S. Pat. Off.

PROVEN IN VOLUME USE!

Widespread Acceptance . . . users report these advantages over conventional glass wire:

- 1.** Improved adhesion, flexibility and toughness— with consequent reduction of damage, breaking or fraying during winding and assembly.
- 2.** Reduction of end taping or extra insulation— due to improved properties.
- 3.** No unraveling—adheres even when hot during tinning of leads.
- 4.** Greater safety factor—positive inorganic spacing between turns provides reliability, protection against overloads.
- 5.** Excellent uniformity—reel to reel—end to end.
- 6.** Over-all savings in winding—no loss of performance.

Any time magnet wire is your problem consult Phelps Dodge for the quickest, easiest answer!

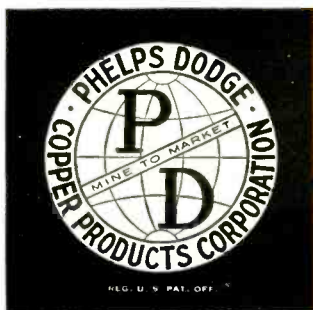

PHELPS DODGE COPPER PRODUCTS
CORPORATION

INCA MANUFACTURING DIVISION
FORT WAYNE, INDIANA

Wincharger dynamotors help power the nation's defense

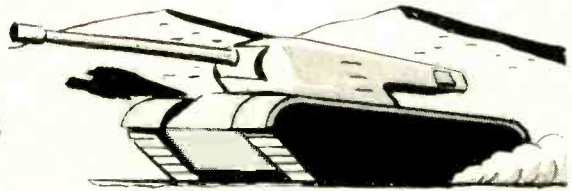

Vehicular HF Communication Transmitters

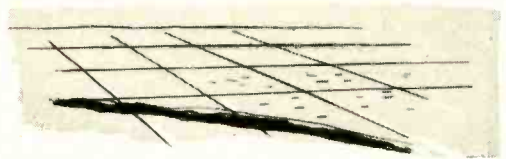

Airborne UHF and HF Communications Transceivers

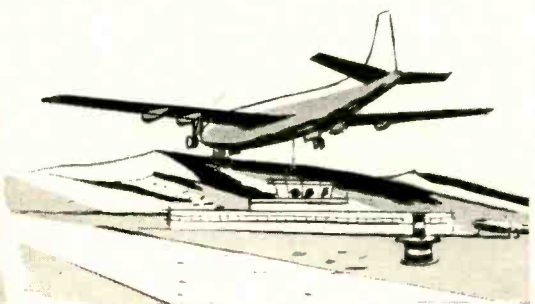

VHF Omirange Navigation Receivers

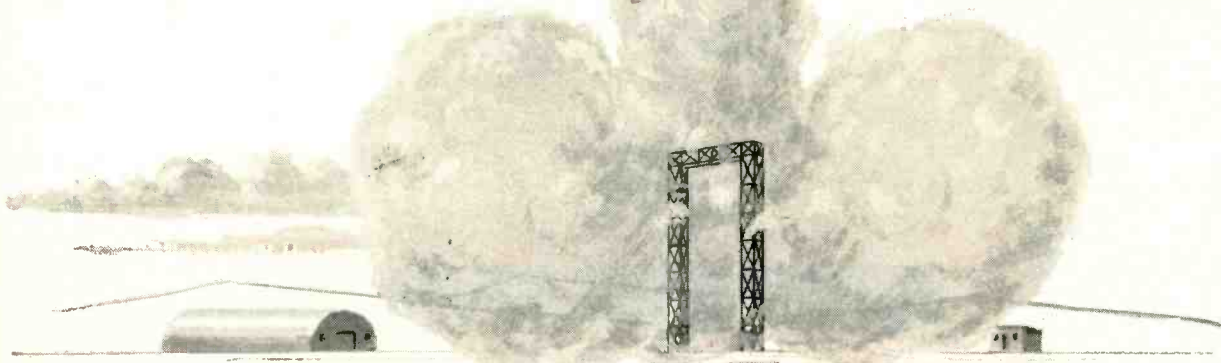

Guided Missile Development

WINCHARGER CORPORATION

Sioux City 2, Iowa

A wholly owned subsidiary of Zenith Radio Corporation

Engine Generators • Universal Motors • Dynamotors
Inverters • Wind Driven Generators

*Speed up
production with*

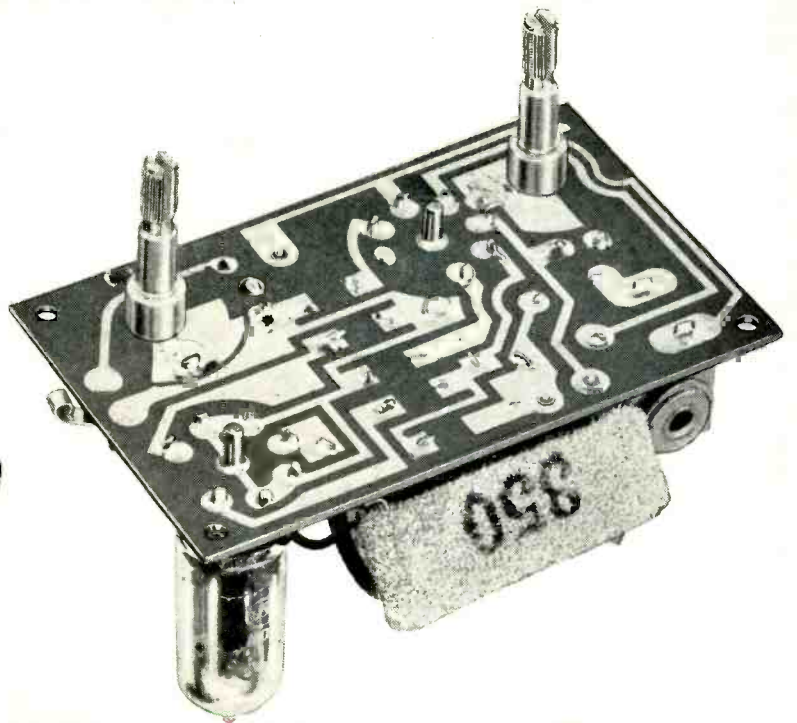

REVERE ROLLED Printed Circuit Copper

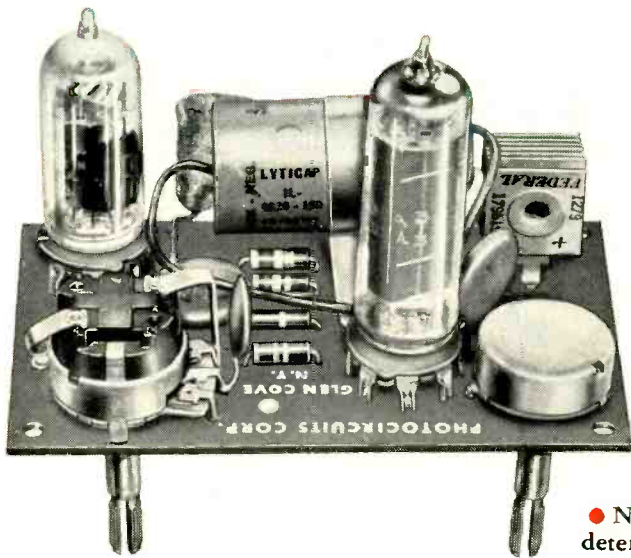

Audio amplifier unit by Photocircuits Corp., Glen Cove, N. Y., using Revere Rolled Printed Circuit Copper.

*Available
NOW!*

● Now that Revere *Rolled* Printed Circuit is available, nothing need deter you from switching to printed circuitry. This copper is supplied to laminators in standard coils of 350 lbs., in widths up to 38", and in .0015" and .0027" gauges, weighing approximately 1 oz. and 2 oz. per square foot.

High in conductivity, uniformly dense through and through and side to side, Revere *Rolled* Printed Circuit Copper is easily etched and soldered.

When ordering blanks from your laminator, specify Revere *Rolled* Printed Circuit Copper.

REVERE

COPPER AND BRASS INCORPORATED

Founded by Paul Revere in 1801

230 Park Avenue, New York 17, N. Y.

Mills: Baltimore, Md.; Brooklyn, N. Y.; Chicago, Clinton and Joliet, Ill.; Detroit, Mich.; Los Angeles and Riverside, Calif.; New Bedford, Mass.; Newport, Ark.; Rome, N. Y.
Sales Offices in Principal Cities, Distributors Everywhere.

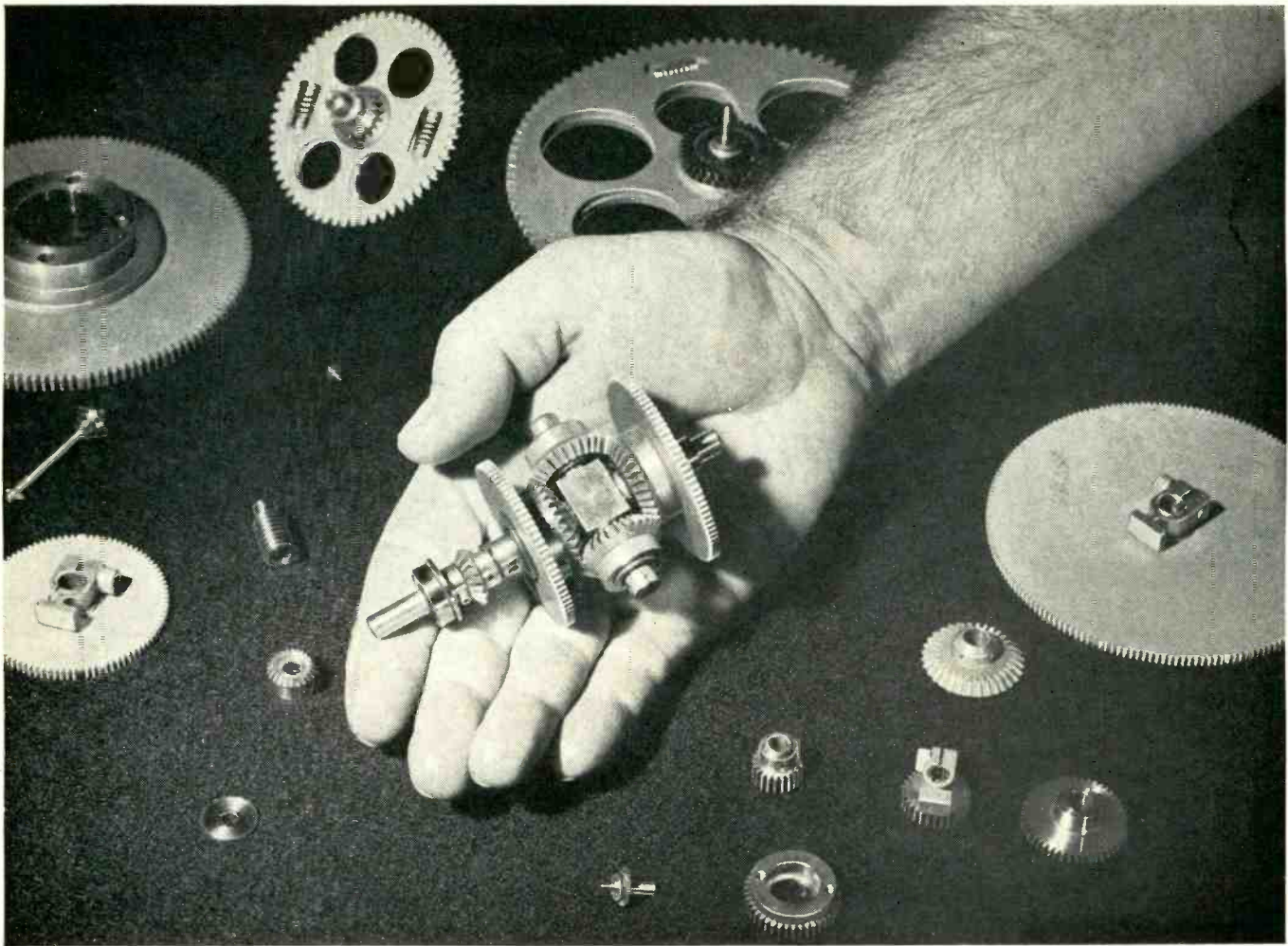

Geared To The "Go"

OF THE MOST PRECISE EQUIPMENT

Spur, bevel, spiral, hypoid, zerol, helical, worm gears . . . anti-backlash gears . . . differentials . . . gear trains . . . complete computers, Atlas "precisioners" them all to the most exacting specifications of electro-mechanical equipment.

Fine gears of all types and the modern equipment to make them are just one phase of the complete facilities of Atlas. Whether your product is a specialized part for electronic equipment or a complete electro-mechanical assembly Atlas will engineer precision assemblies and components to your requirements.

Atlas design, production and methods engineers, toolmakers and skilled mechanics work right along with you on a job basis. Every modern cost-cutting tool and technique is at your service . . . plus quality control, functional testing and modern electronic recording gear checking equipment.

From idea stage to production efficiency Atlas "creative engineering" can help you get your product *underway* quicker and at lower costs. Write today for booklet "Precisionering Electro Mechanical Equipment." Atlas Precision Products Co., Philadelphia 24, Pa., (Division of Prudential Industries).

"From Drawing Board . . . to Production Line"



ATLAS

Precision Products



AMAZING POWER

TYPE X-80 CLIPPER DIODE-RECTIFIER

High peak power capabilities of type X-80 in relation to its physical size have been accomplished through an unusually forceful combination of design features.

1. Exclusive UNITED bonded *thoria tungsten core filament* for high electron emissivity.

2. Exclusive UNITED *graphite anode* for maximum thermal dissipation.

3. Exclusive UNITED *isolated getter traps* for retention of hard vacuum and high voltage internal insulation.

Type X-80 is serving importantly as a high current clipper tube in radar equipment employing the large hydrogen thyratrons, as well as in power supply rectifier applications.

Write for detailed specifications.

40
Kilovolts
Inverse Peak

80
Amperes
Peak Plate Current
as shunt diode

800 mAdc
(average)
as a rectifier

Filament
Ratings
11.5 Volts Nominal
15.5 Amperes

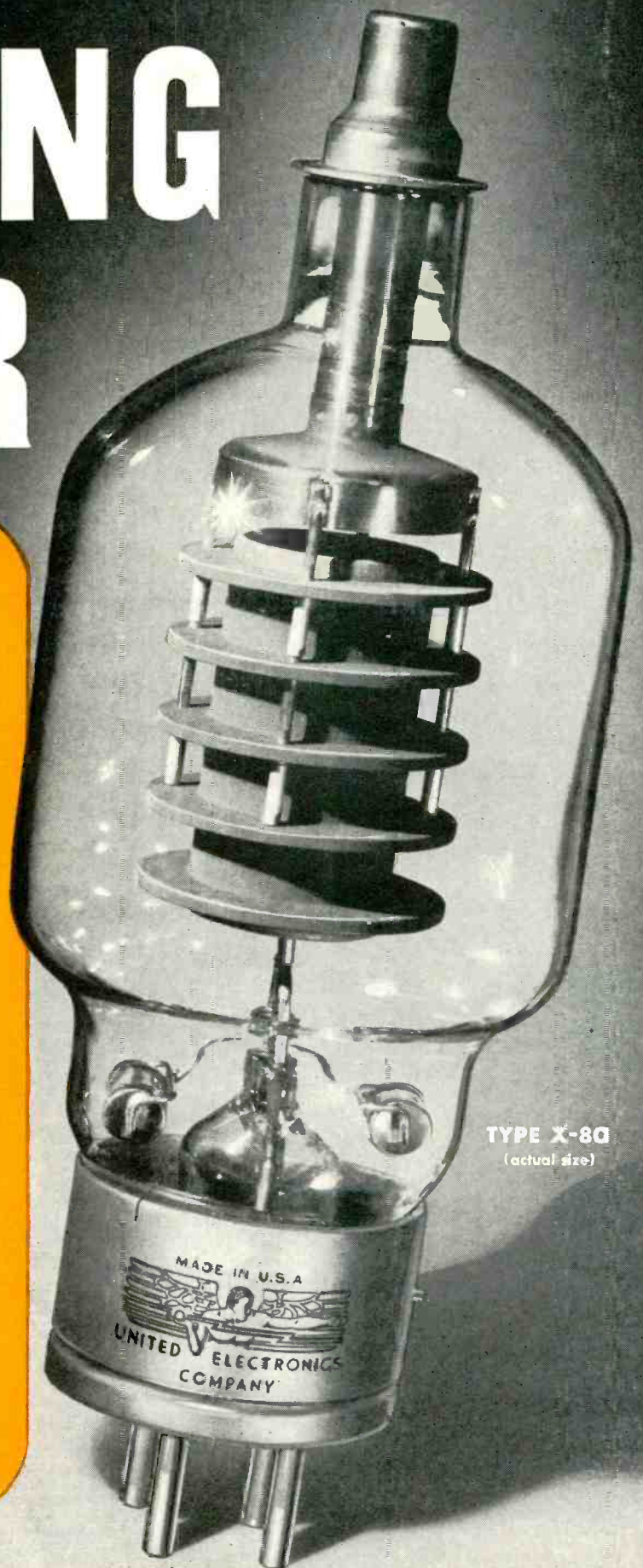

TYPE X-80
(actual size)

UNITED  ELECTRONICS, 42 Spring Street, Newark 4, N. J.
TRANSMITTING TUBES EXCLUSIVELY Since 1934

AT YOUR SERVICE

over 2000 scientists, electrical engineers, chemists, physicists, mechanical engineers, mathematicians, designers, technicians and skilled craftsmen who have available over 400,000 square feet of laboratories and manufacturing plants.

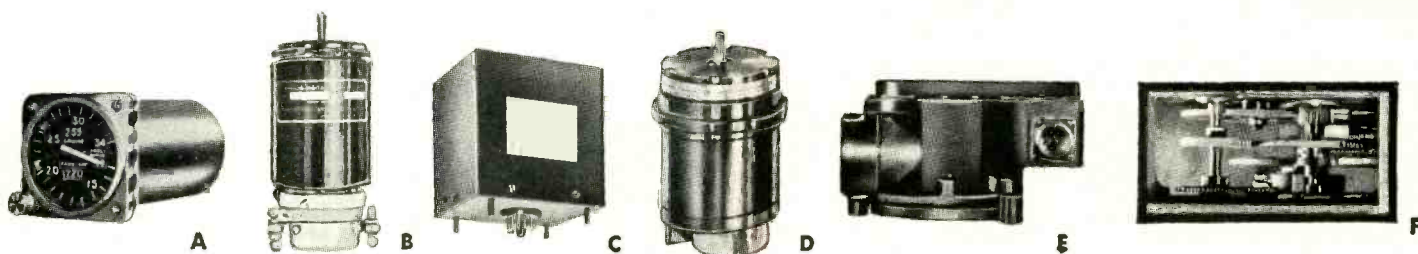

Look to Norden-Ketay—leader in research, design, development and mass production of SYNCHROS • SERVO MOTORS • DIGITAL CONVERTERS • RATE GENERATORS • RESOLVERS • MAGNETIC AMPLIFIERS • GEAR TRAINS • POTENTIOMETERS • NAVIGATIONAL SYSTEMS • FIRE CONTROL SYSTEMS • SERVO MECHANISMS • AIRBORNE INSTRUMENTS • BOMB DIRECTOR SYSTEMS • AIR DATA INSTRUMENTS • COMMUNICATION EQUIPMENT • COMPUTERS • PRESSURE GAUGES

NORDEN-KETAY CORPORATION

99 Park Avenue, New York 16, New York

RESEARCH & DEVELOPMENT LABORATORY: *The Norden Laboratories, White Plains, N. Y.*

MANUFACTURING DIVISIONS: *Precision Components Division, New York, N. Y.*
Commack, Long Island, N. Y. • Hawthorne, California
Instrument and Systems Division, Milford, Connecticut

SUBSIDIARIES: *Nuclear Science and Engineering Corporation, Pittsburgh, Pa.*
Vari-ohm Corp., Amityville, Long Island, N. Y.
Scientific Specialties Corporation, Boston, Mass.

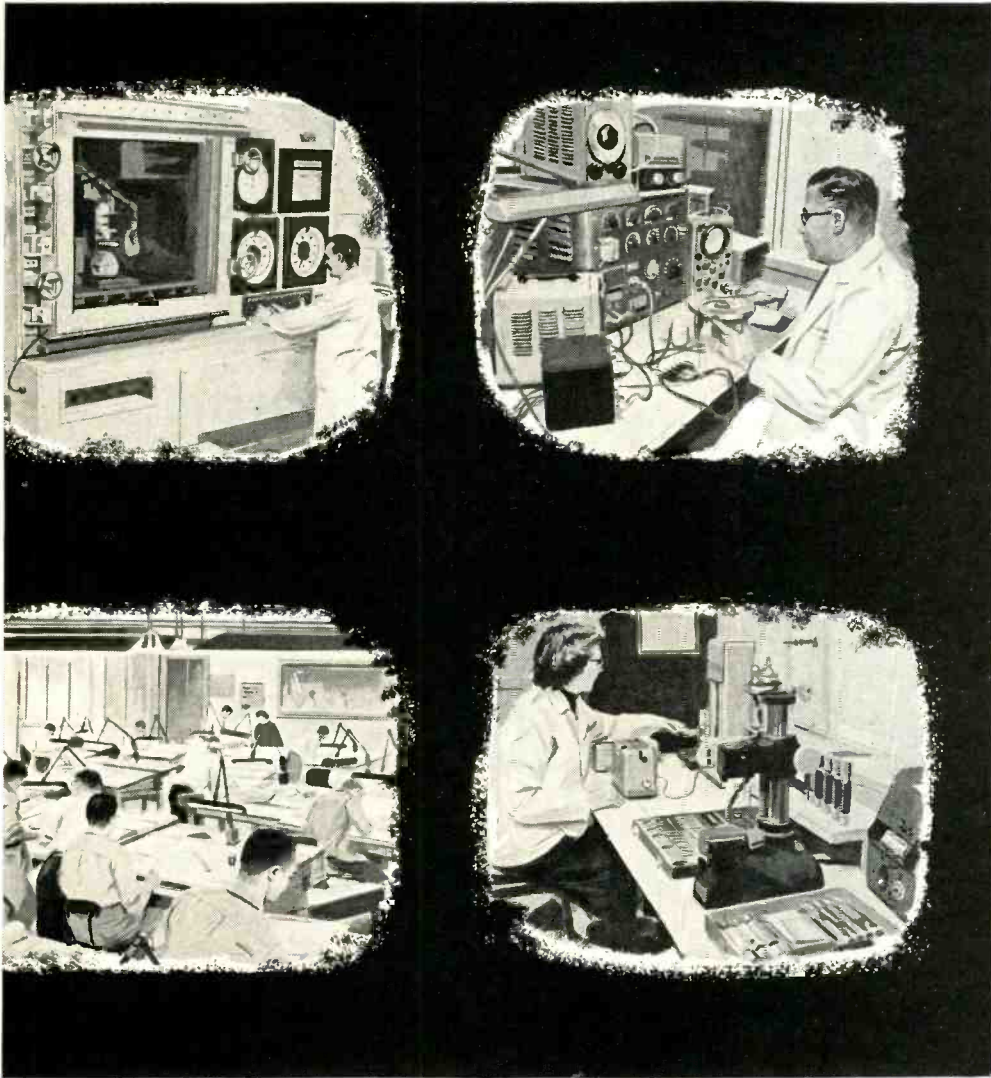

A...Jet Engine Pressure Ratio Systems. Noted for low weight, small size, accuracy, stability, sensitivity. Refer to Bulletin #361.

B...Digital Converter. Possible rate of 25,000 counts per minute, an unambiguous output of 13 binary digits in natural binary code. Refer to Bulletin #360.

C...Magnetic and Electronic Amplifiers. Open, dust-proof or hermetically sealed units. Either standard or to customer specifications. Write for specific data.

D...Synchros, Servo Motors and Resolvers. Specifications and characteristics of over 130 sizes and types are given in Bulletin #355.

E...Fuel Flow Transmitters. Major instruments, components, and systems for aircraft are available. Write for specific data.

F...Gear Trains. Conventional and miniaturized types for use with servo motors and synchros.

G...Potentiometers. Linear and non-linear, ten-turn potentiometers, single-turn continuous units and others are described in Bulletin #321.

H...Acragage Bourdon Tube Gauges. Pressure, vacuum and compound for the petroleum, chemical, and industrial field. AN types for aircraft. Refer to Bulletin #364.

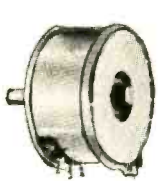

G

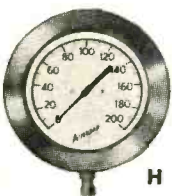

H

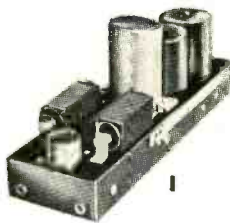

I

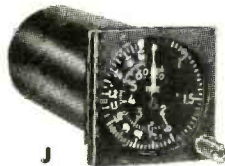

J

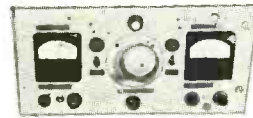

K

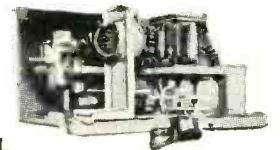

L

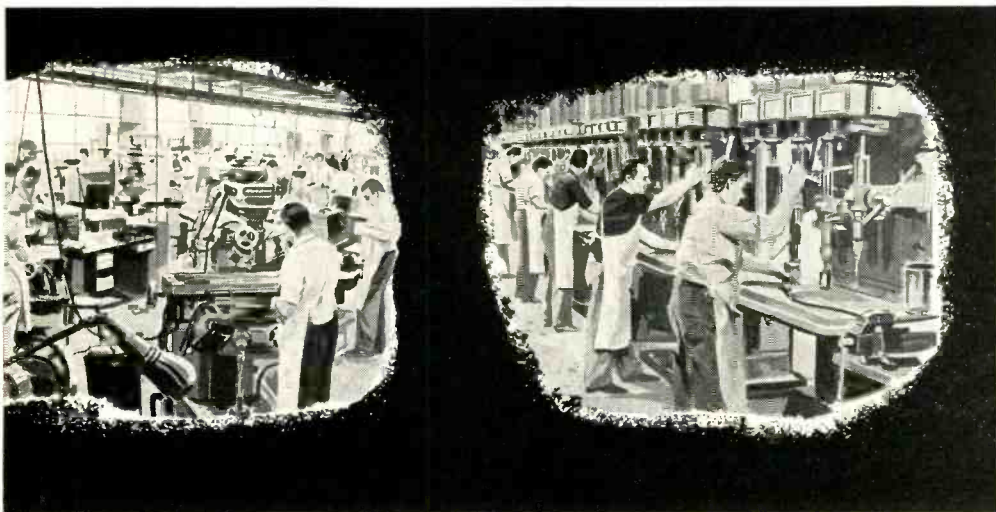

I...Servomechanisms. Made to meet extremes of temperature, humidity, and special configuration. Submit your requirements.

J...Air Data Instrumentation. Engineers are available to show how our experience in this field can help you in the solution of your problems.

K...Marine Equipment. Interior communication equipment, salinity indicators, engine order telegraphs, compass repeaters, and marine equipment. Write for specific data.

L...Electro-Mechanical Assemblies. Complete engineering and manufacturing facilities are available for sub-contracts of complete equipments.

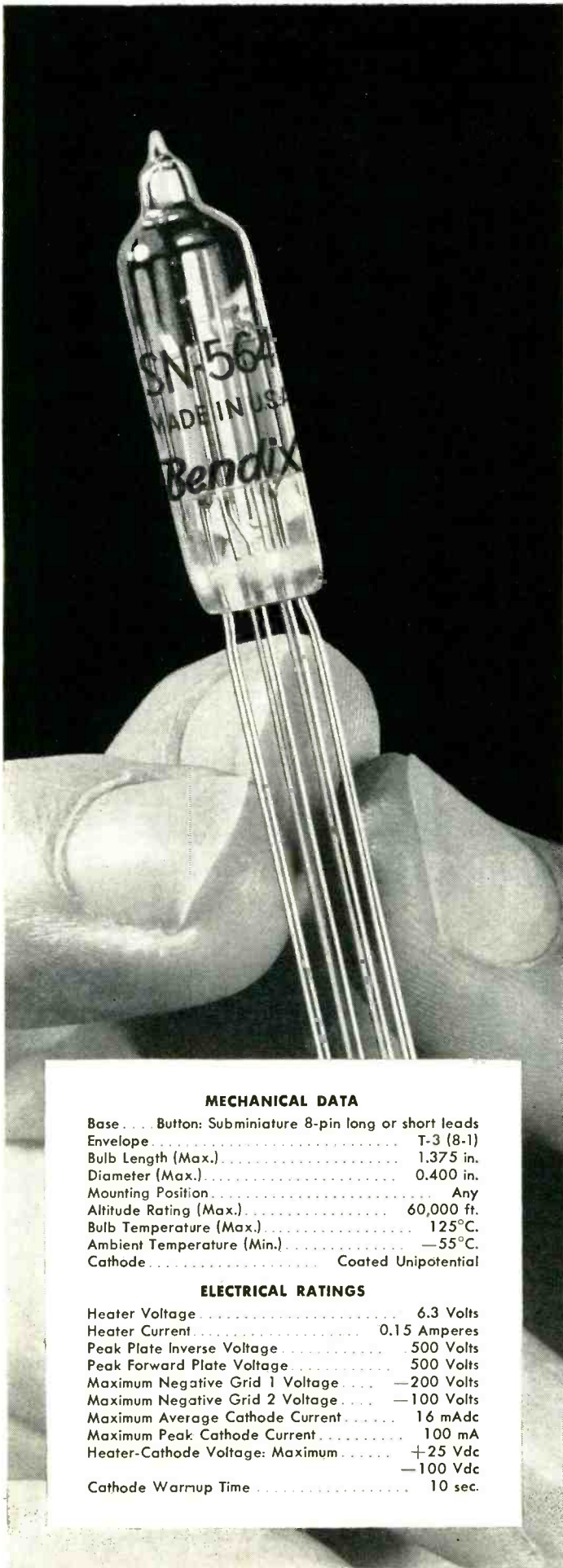

Now available—
subminiature xenon
tetrode thyatron

RETMA 5643



Improved Type TD-17

APPLICATIONS: Counters, grid control rectifiers, gyro erection systems, missile systems, automatic flight control systems, and other control circuits requiring utmost degree of reliability.

ADVANTAGES: Freedom from early failure . . . long service life . . . uniform operating characteristics . . . ability to withstand severe shock and vibration.

FEATURES: Advanced mechanical and electrical design plus 100% microscopic inspection during manufacture . . . special heater-cathode construction minimizes shorts . . . 24-hour run-in tests under typical overload conditions.

The TD-17 is but one of many electron tubes designed and built by Bendix Red Bank for special-purpose applications. For full information on the TD-17, or on other tubes for other uses, write RED BANK DIVISION, BENDIX AVIATION CORPORATION, EATONTOWN, NEW JERSEY.

West Coast Office: 117 E. Providencia Ave., Burbank, Calif.

Canadian Distributor:

Aviation Electric Ltd., P. O. Box 6102, Montreal, P.Q.

Export Sales and Service:

Bendix International Division, 205 E. 42nd St., New York 17, N. Y.

MECHANICAL DATA

Base	Button: Subminiature 8-pin long or short leads
Envelope	T-3 (8-1)
Bulb Length (Max.)	1.375 in.
Diameter (Max.)	0.400 in.
Mounting Position	Any
Altitude Rating (Max.)	60,000 ft.
Bulb Temperature (Max.)	125°C.
Ambient Temperature (Min.)	-55°C.
Cathode	Coated Unipotential

ELECTRICAL RATINGS

Heater Voltage	6.3 Volts
Heater Current	0.15 Amperes
Peak Plate Inverse Voltage	500 Volts
Peak Forward Plate Voltage	500 Volts
Maximum Negative Grid 1 Voltage	-200 Volts
Maximum Negative Grid 2 Voltage	-100 Volts
Maximum Average Cathode Current	16 mA _{dc}
Maximum Peak Cathode Current	100 mA
Heater-Cathode Voltage: Maximum	+25 Vdc
	-100 Vdc
Cathode Warmup Time	10 sec.





HIGH

temperature
strength
quality
production

with new

Greatly enlarged facilities now produce high quality, pace-setting ALSiMag Alumina ceramics in quantity lots. Complete range of up-to-the-minute Alumina compositions now permit you to design to higher temperatures and higher strengths. Advantages include improved electrical characteristics at elevated temperatures—beyond the melting point of most metals. Higher tensile and impact strengths. Greater resistance to corrosion and abrasion. Smoothness of texture. Close dimensional tolerances. Custom formulations for special needs.

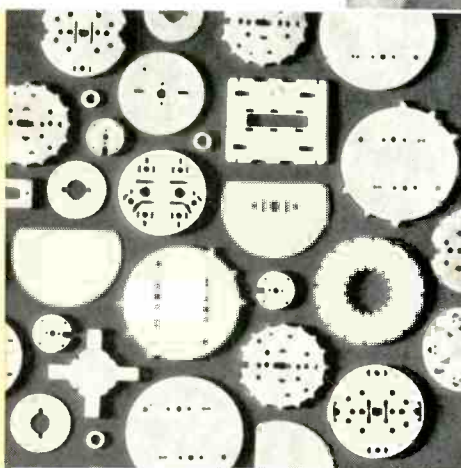
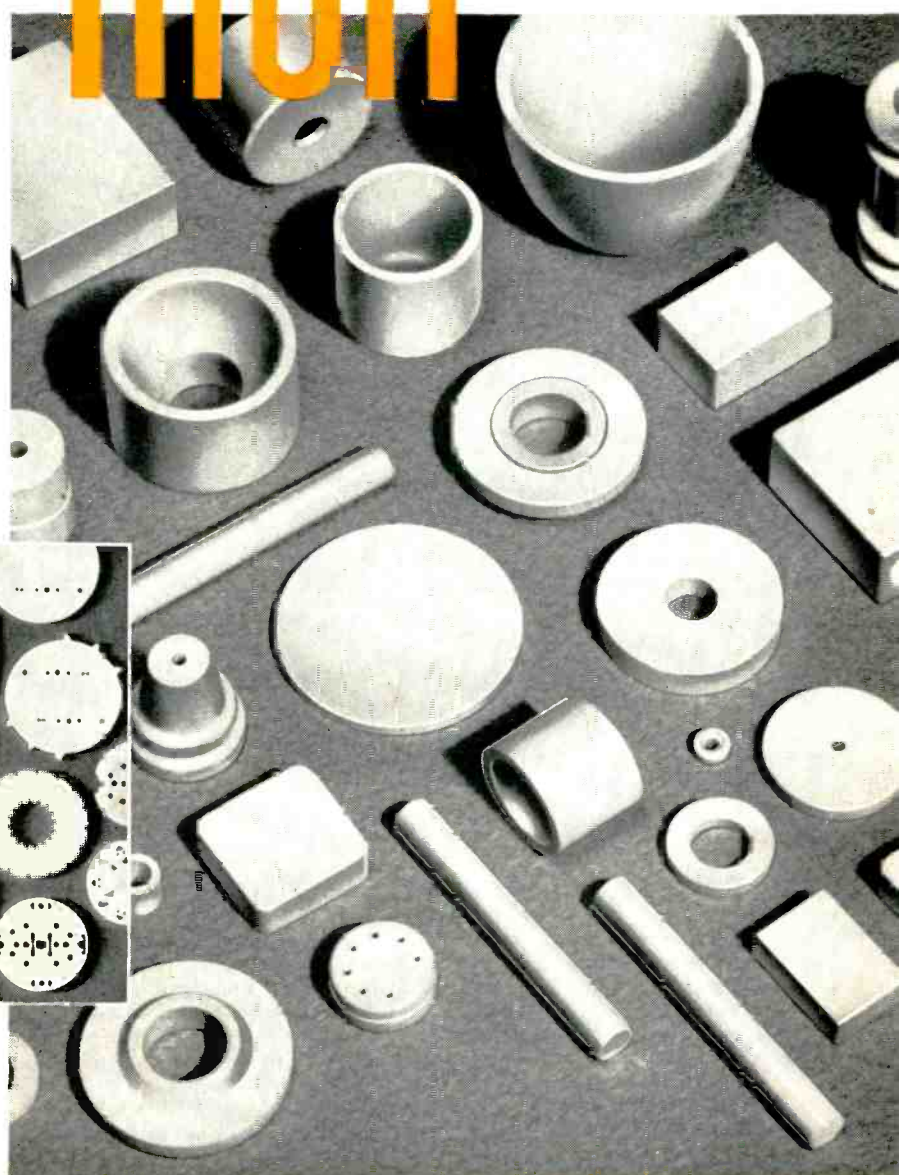

Volume production in a complete range of precision parts, including electron tube shapes processed to be highly porous, readily degassed, thicknesses as low as .009".

• An outline of your requirements, enclosing a blueprint or sketch, will bring you full details.

54TH YEAR OF CERAMIC LEADERSHIP

AMERICAN LAVA CORPORATION

CHATTANOOGA 5, TENNESSEE
A Subsidiary of
Minnesota Mining and Manufacturing Company

Branch offices in these cities (see your local telephone directory): Cambridge, Mass. • Chicago, Ill. • Cleveland, Ohio • Dallas-Houston, Texas • Indianapolis, Ind. • Los Angeles, Calif. • Newark, N. J. • Philadelphia, Pa. • St. Louis, Mo. • South San Francisco, Calif. • Syracuse, N. Y. • Tulsa, Okla. **Canada:** Irvington Varnish & Insulator Div., Minnesota Mining & Mfg. of Canada, Ltd., P. O. Box 757, London, Ontario. **All other export:** Minnesota Mining & Mfg. Co., International Division, 99 Park Ave., New York, N. Y.



FIRE CONTROL RADAR

...adapted by **Admiral**[®]
to rise above present flight ceilings

When present flight ceilings of military aircraft are again elevated, the fire control radar apparatus will be ready to rise with the planes. Admiral's development work on the basic unit has eliminated the need for pressurization to prevent voltage break-downs at extremely high altitudes. In solving this central problem, a host of vexing collateral problems have been eliminated. As developed and built by Admiral, the unit is compact, lightweight, and needs no bulky, expensive cooling system to dissipate internal heat.

Here is another example of Admiral's many contributions to the science of military electronics. Exceptional facilities are available for research, development and production of electronic or electro-mechanical equipment. Address inquiries to:

Admiral Corporation
Government Laboratories Division, Chicago 47, Illinois

NOTE: NEW COLOR SOUND FILM on Admiral Automation available for showing to technical or business groups. Address requests to Public Relations Director, Admiral Corporation, Chicago 47, Ill.

LOOK TO **Admiral** FOR RESEARCH • DEVELOPMENT PRODUCTION

In the fields of:

COMMUNICATIONS, UHF AND VHF, airborne and ground.
MILITARY TELEVISION, receiving and transmitting, airborne and ground.
RADAR, airborne, ship and ground.
RADIAC • MISSILE GUIDANCE • TELEMETERING
• DISTANCE MEASURING • TEST EQUIPMENT
• CODERS AND DECODERS

FACILITIES BROCHURE

describing Admiral plants, equipment and experience sent on request.



ENGINEERS: The wide scope of work in progress at Admiral creates challenging opportunities in the field of your choice. Write Director of Engineering and Research, Admiral Corporation, Chicago 47, Ill.

Government model TS-148/UP Frequency-meter Range - 8470 to 9630 MC/S²5 MC/S max. error.
Sensitivity to CW - Spectrum Amplified Pos. - 80 db. below 1 watt for 1 inch deflection.

SPECTRUM ANALYZER

Spectrum Position - 55db. below 1 watt for 1 inch deflection. Maximum dispersion of spectra.
Attenuation - uncalibrated. Variable 3 to 70 db. 1.5 MC/S per inch.



GOVT. MODEL
TS-148/UP

**NORTHEASTERN
ENGINEERING, INC.**

manchester, new hampshire



REVOLUTIONARY gives NET PRICES for



ANTI-CORROSIVE Metal Products Co., Inc.
109 River Rd., Castleton-on-Hudson, N. Y.
Please send me my FREE copy of the new all-in-one catalog.

Name.....Title.....
Company.....
Street.....
City.....State.....



Use this coupon to order
your FREE COPY TODAY!

NEW CATALOG STAINLESS FASTENINGS

REVISED TWICE YEARLY—ALWAYS UP TO DATE!

For the first time, a catalog that gives *net prices* in various quantity brackets . . . PLUS actual quantities of more than 9,000 items and sizes *in stock!* All this in ONE catalog, all information for each item in ONE line . . . all the data you need *at a glance!*

1. LISTING of over 9,000 items and sizes in different stainless analyses

2. Actual QUANTITIES of America's largest inventory of stainless fastenings

All prices				NET PRICE PER THOUSAND				
Lgth.	Description	Type	Quantity	Up to 500	500-1999	2000-4999	5000-9999	10,000-14,999
	Truss	304	32466 *	19.00	17.10	15.39	13.85	
	Truss A-N	304	13140	17.10	15.39	13.85		
		304	4329 *	19.00				
		#10	1950					

3. NET PRICES of stock items in various quantity brackets

NEW LOWER PRICES!

Another *plus* . . . you'll find appreciable savings on many items listed in this new all-in-one reference catalog! One more reason to check Anti-Corrosive FIRST for stainless steel fastenings!



ANTI-CORROSIVE
METAL PRODUCTS CO., INC.

CASTLETON-ON-HUDSON, N. Y.

Make LIGHT and COLOR Behave

... to contract specifications

Controlling light to your performance requirements is routine with Bausch & Lomb. Standard production includes hundreds of different optical elements to keep your product designs simple and your costs down. And B&L optical competence assures prompt, dependable execution of special orders for volume manufacture . . . from components to complete instruments and equipments. B&L may well prove the expediting factor in your present defense contract plans. Why not find out right now?

WRITE, WIRE OR PHONE

for complete information on B&L optical products. Bausch & Lomb Optical Co., 81247 St. Paul St., Rochester 2, New York. Phone: LOcust 3000.



BAUSCH & LOMB

SINCE  1853

America's only complete optical source . . . from glass to finished product

TUNG-SOL[®]

12AB5

**AUDIO
POWER
AMPLIFIER**



*The First Audio Power Amplifier Designed
Specifically for Automobile Radio Service*



see other side for additional information



TUNG-SOL AUDIO

A TUNG-SOL

POWER AMPLIFIER

DESIGNED AND DEVELOPED TUBE

12AB5

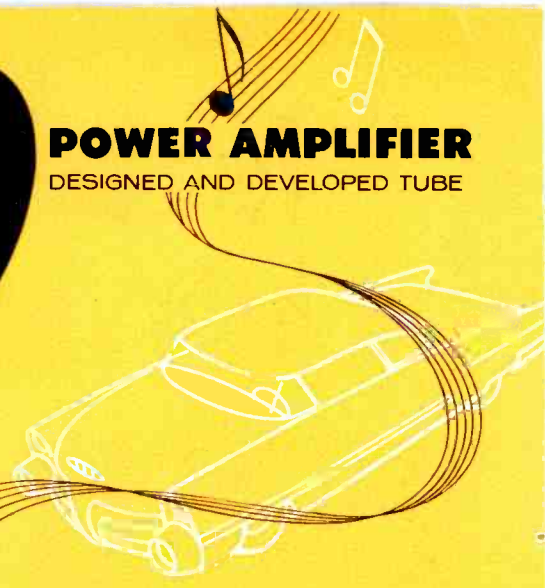

Greater Factor of Safety Assures Continuity of Service

12AB5 is the first audio power amplifier designed specifically for automotive radio service. In both design and ratings, this tube is specifically intended for the 12-volt systems adopted by leading car manufacturers.

There has been no compromise with household radio or TV needs in engineering the 12AB5. The design recognizes the wide range of operating voltage to which an automotive receiver is subjected during idling and full charge conditions of the storage battery.

This new tube is intended to be used either singly or in push-pull for power output stage use. Its nine-pin construction in an all-glass miniature envelope, provides a wider margin of safety than the previous smaller seven-pin 6AQ5 and 12AQ5.

The 12AB5 is in full production under the rigid quality control procedures that keep Tung-Sol tube performance at the top of the industry.

MECHANICAL DATA

Coated unipotential cathode		Bulb	T-6 1/2
Outline drawing	RETMA 6-3	Miniature button	9 pin
Base	RETMA E9-1		3/4"
Maximum diameter			2 3/8"
Maximum overall length			2 3/8"
Maximum seated height			9 CK
Base pin connections:		Basing	
Pin 1—grid #2		Pin 6—grid #1	
Pin 2—no connection		Pin 7—grid #3, cathode	
Pin 3—grid #1		Pin 8—grid #2	
Pin 4—heater		Pin 9—plate	
Pin 5—heater			
Mounting position			Any

ELECTRICAL DATA

Heater Characteristics*

Heater voltage—nominal	12.6	VOLTS
Heater current—nominal	0.2	AMP.

Direct Interelectrode Capacitances—APPROX.

Grid to plate: G to P	0.7	μf
Input: G1 to (H+K+G2&G3)	8.0	μf
Output: P to (H+K+G2&G3)	8.5	μf

Bulb Temperature—MAXIMUM

	250	°C.
--	-----	-----

Ratings—Interpreted According to Design Center System

ELECTRICAL DATA

Maximum plate voltage	315	VOLTS
Maximum grid #2 voltage	285	VOLTS
Maximum plate dissipation	12	WATTS
Maximum grid #2 dissipation	2	WATTS
Maximum grid #1 circuit resistance		
Fixed bias	0.1	MEG.
Cathode bias	0.5	MEG.
Maximum heater—cathode voltage		
Negative (DC)	200	VOLTS
Positive (DC)	100	VOLTS

Operating Conditions and Characteristics*

Class A1 Amplifier—single tube			
Heater voltage*	12.6	12.6	VOLTS
Plate voltage	250	250	VOLTS
Grid #2 voltage	200	250	VOLTS
Grid #1 voltage	...	-12.5	VOLTS
Cathode bias resistor	270	...	OHMS
Peak AF grid #1 voltage	10.5	12.5	VOLTS
Zero-signal plate current	33.5	45	MA.
Maximum signal plate current	36.0	47	MA.
Zero-signal grid #2 current	1.6	4.5	MA.
Maximum signal grid #2 current	3.2	7.0	MA.
Plate resistance	...	50	KIL.
Transconductance	4000	4100	μMHOS
Load resistance	6000	5000	OHMS
Power output (maximum signal)	3.3	4.5	WATTS
Total harmonic distortion	12	8	%

*This tube is intended to be used in automotive service from a nominal 12 volt battery source. The heater is therefore designed to operate over the 10.0 to 15.9 voltage range encountered in this service. The maximum ratings of the tube provide for an adequate safety factor such that the tube will withstand the wide variation in supply voltages.

TUNG-SOL ELECTRON TUBES

The TUNG-SOL engineering which has produced the 12AB5 is constantly at work on a multitude of special electron tube developments for industry. Many exceptionally efficient general and special purpose tubes have resulted. Information about these and other types is available on request to Tung-Sol Commercial Engineering Department.

TUNG-SOL ELECTRIC INC., NEWARK 4, NEW JERSEY

SALES OFFICES: ATLANTA, CHICAGO, COLUMBUS, CULVER CITY, DALLAS, DENVER, DETROIT, NEWARK, SEATTLE.

NOVEMBER, 1955



MINIATURE LAMPS



SEALED BEAM HEADLAMPS



SIGNAL FLASHERS



RADIO AND TV TUBES



ALUMINIZED PICTURE TUBES



SPECIAL PURPOSE TUBES



SEMICONDUCTORS

Two new "tools" to help you pin point vibration

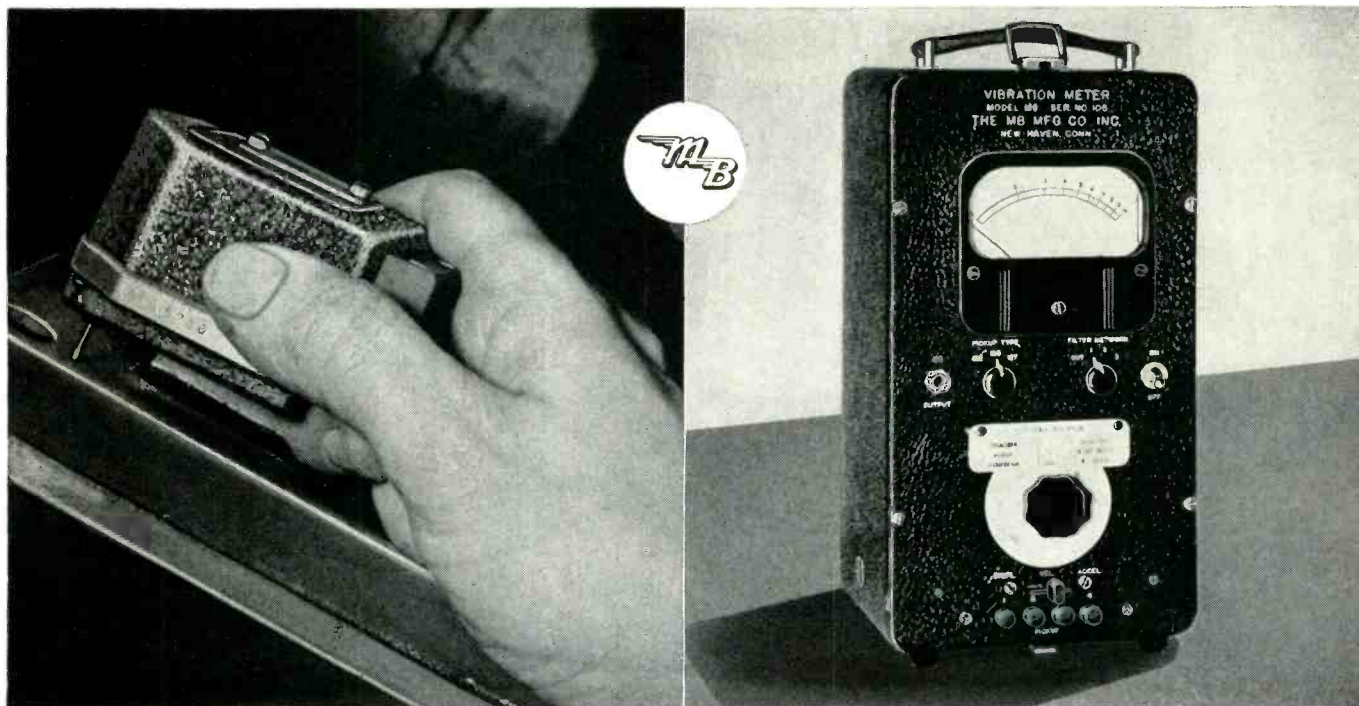

MB Probe-type Pickup and Portable Meter

simplify reliable vibration detection and measurement

Here's the pickup that really searches out vibration. It combines the extreme sensitivity of electromagnetic operation with the wide usefulness of a hand-held probing instrument.

With this new MB Type 115 Pickup, you can explore large panels . . . bearings, housing, structural members, bodies large and small. Since the light probe adds negligible loading or weight to the vibrating object, it translates any vibration into voltage with great accuracy for measurement. It lets you pin-point the trouble . . . determine quickly any need for corrective design.

The improved Model M6 MB Vibration Meter teams up with the pickup to give you the facts on vibration. With it, you measure the voltage generated in the pickup directly . . . in useful terms of amplitude, velocity, or acceleration of the vibratory motions.

You can connect as many as four MB Pickups to this meter . . . a selector switch enabling you to read any one at a time. The meter is portable, compact, ruggedized and operates on standard AC.

To lick vibration, you've got to locate it first. You'll find this pair a big help for that job. Write for more data.



manufacturing company

A division of Textron American, Inc.

1060 State Street,
New Haven 11, Conn.

PRODUCTS TO ISOLATE VIBRATION . . . TO EXCITE VIBRATION . . . TO MEASURE VIBRATION

New Oriented Silicon Steels for LIGHTER-WEIGHT Transformers

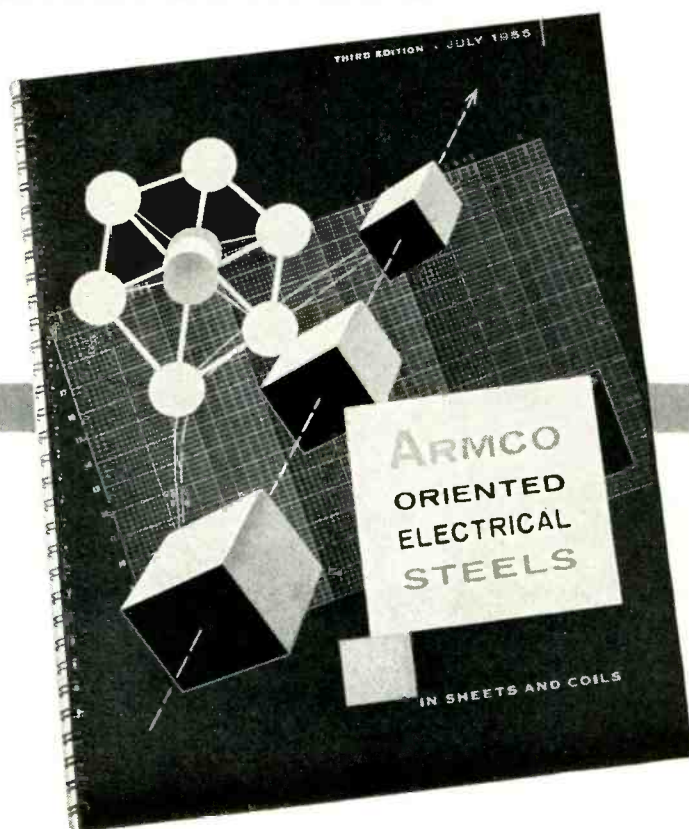

Armco Oriented Electrical Steels have spearheaded revolutionary changes in transformer design for the last 15 years because of these principal advantages:

Lower Core Loss

These electrical steels give the designer silicon steels with much lower core loss in the rolling direction than any conventional cold-reduced or hot-rolled grades.

Higher Permeability

The Armco oriented grades have another unique advantage over conventional electrical steels—higher permeability at high inductions combined with lower core loss. Before the introduction of oriented silicon steel, lowered core loss was obtained only at the expense of permeability at high transformer inductions. As core loss improved, the exciting current became the limiting factor in

design. The oriented grades overcame this handicap.

Other Advantages

In addition to lower core loss and higher permeability in the rolling direction, Armco Oriented Electrical Steels have excellent lamination factors and surface insulations. They are supplied with magnetic properties fully developed at the mill. Only a low-temperature (1475 F) anneal is required for stress-relieving.

New Information Available

Original grades of Armco Oriented Electrical Steel are long obsolete, replaced by lower core loss grades. Magnetic data now available are more complete.

Write us on your company letterhead for a copy of "Armco Oriented Electrical Steels—Third Edition, July, 1955." This 56-page catalog gives extensive information on the present Armco Oriented grades, M-6W, M-7W, M-6X and M-7X.



ARMCO STEEL CORPORATION

1515 CURTIS ST., MIDDLETOWN, OHIO

SPECIAL STEELS

SHEFFIELD STEEL DIVISION • ARMCO DRAINAGE & METAL PRODUCTS, INC. • THE ARMCO INTERNATIONAL CORPORATION

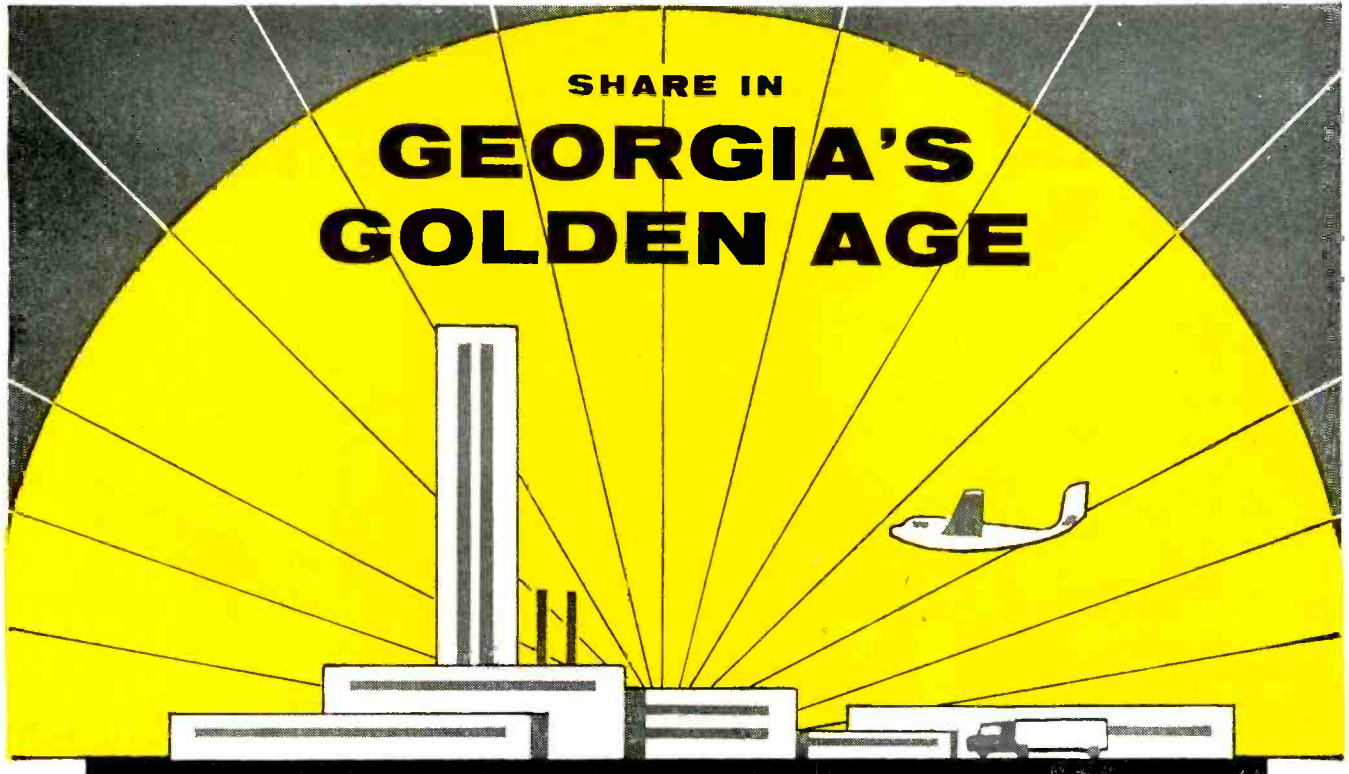

ARE YOU IN THE ELECTRONICS FIELD?

Whatever You Make...Whatever You Sell...

... you, too, will find that it's good business to produce in Georgia. Over 7100 manufacturers, including many of America's greatest industrial names, have already staked their claims to share in Georgia's Golden Age. Georgia—scene of America's first gold rush in 1828, today offers many nearby, growing consumer markets to sales-minded industries...



Open For Business Every Day In The Year

Even the weather is on your side in Georgia, where every day is production day. Industry is on the move to Georgia... with an amazing array of natural and physical resources, readily accessible and in abundant supply. Superb transportation—plus a liberal pool of intelligent workers make it easy to produce and move goods fast!

Get the facts from Scott Candler, Secretary — Dept. 23

GEORGIA DEPT. OF COMMERCE

SCOTT CANDLER, SECRETARY • 100 STATE CAPITOL • ATLANTA, GEORGIA



OFFERS MORE TYPES OF 1%

Deposited Carbon

Here's 1% accuracy in an extremely stable non-wire wound resistor at a price low enough to permit its use wherever the characteristics of composition carbon resistors are not fully suited. IRC's unmatched experience in producing film type resistors has led directly to the superior reliability and stability of IRC Deposited Carbons. Outstanding characteristics include load, environmental and age stability and ability to operate at higher temperatures than MIL specification requirements, low wattage coefficient, and low capacitive and inductive reactance in high frequency applications.

3 SMALL SIZES—DCC ½ WATT
DCF 1 WATT and DCH 2 WATTS

MEET ALL REQUIREMENTS OF
MIL-R-10509A SPECIFICATION

Wherever the Circuit Says

Subsidiaries :

Circuit Instruments Inc., St. Petersburg, Fla. • Hycor Company, Los Angeles, Calif. and Vega Baja, Puerto Rico • IRCAL Industries, Los Angeles, Calif.

Molded Deposited Carbon

Molded Deposited Carbon resistors are now available from IRC in 3 sizes: Types MDA—½ watt, MDB—¼ watt and MDC—½ watt. The molded plastic housing provides complete mechanical protection, minimizes the effect of moisture and improves load life characteristics. These 1% precision film type units exceed MIL-R-10509A specifications.

COMPARISON SURFACE TEMPERATURE RISE VS. LOAD
Molded vs. Unmolded Deposited Carbon Resistors

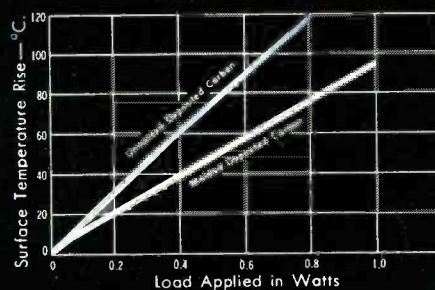

Boron Carbon

Where a high degree of accuracy under widely varying temperatures is required, IRC Boron Carbons offer an ideal combination of characteristics. Their superior temperature stability is provided in 3 sizes: Types BOC—½ watt, BOF—1 watt and BOH—2 watts—all 1% accuracy. Considering weight, size and cost factors, plus lower capacitive and inductive reactance, these film type precision resistors can satisfactorily replace wire wounds.

IRC TYPE	BOC	BOF	BOH
Equivalent MIL Style	RN 20R	RN 25R	RN 30R
Wattage (40°C. Ambient)	½	1	2
Max. Continuous Voltage	350 V.	500 V.	750 V.
Minimum Ohms	10	20	30
Maximum Ohms (IRC)	0.5 meg	2.0 meg	5.0 meg

makes them all... can recommend without bias...

TOLERANCE RESISTORS than any supplier in the industry

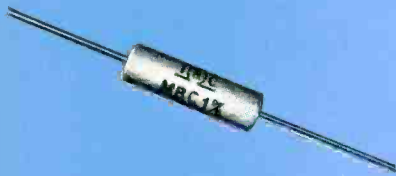

Molded Boron Carbon

Only from IRC can you obtain Boron Carbon resistors with the protection of a molded plastic housing. Any risk of mechanical damage to the coating or of insulation breakdown is overcome. Any need for special handling is eliminated, and moisture and load life characteristics are improved. 3 sizes—Types MBA 1/4 watt, MBB 1/4 watt and MBC 1/2 watt—all exceed MIL-R-10509A specifications.



Wire Wound

IRC's winding skills and automatic assembly equipment provide precision windings to exacting standards. Continuous inspections at every stage of manufacture assure maximum reliability in each finished resistor. IRC Mil Type precision wire wounds meet all requirements of MIL-R-93A specification. In addition to 6 Mil sizes, IRC supplies tiny Type WW10J—1 1/2 x 1/2". Standard tolerance ±1%; minimum tolerances are shown below.

Minimum Tolerances

Resistance	IRC MIL TYPES	TYPE WW10J
10 ohms & up	0.1%	
5 ohms & up	1.25%	
1 ohm & up	0.5%	
1500 ohms & up		0.1%
200 ohms & up		0.25%
65 ohms & up		0.5%



Encapsulated Wire Wound

Tru-Mite encapsulated wire wound precision resistors are produced to IRC's high standards by its West Coast subsidiary, IRCAL INDUSTRIES. Available in 11 sizes and axial lead or lug types. Standard tolerance ±1%; also ±1/2, 1/4, 1/10 and 1/20% tolerances can be supplied. Tru-Mite core material is the same epoxy resin as is used for the embedment. This eliminates the normal effects of temperature and moisture. Tru-Mite resistors exceed MIL-R-93A specifications.

TYPICAL TEMPERATURE COEFFICIENT

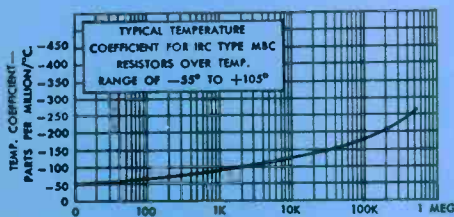

MANY COMBINATIONS OF CHARACTERISTICS AND OPPORTUNITIES FOR COST REDUCTION ARE INVOLVED WHEN SPECIFYING CLOSE TOLERANCE RESISTORS. NO OTHER SINGLE SOURCE CAN OFFER YOU THE SCOPE OF TECHNICAL GUIDANCE AVAILABLE FROM IRC.

use coupon for complete data!

In Canada:

International Resistance Co., Ltd., Toronto, Licensee

INTERNATIONAL RESISTANCE COMPANY

Dept. 235, 401 N. Broad St., Philadelphia 8, Pa.

SEND ME TECHNICAL BULLETINS ON—

- Deposited Carbons
 Molded Deposited Carbons
 Boron Carbons Molded Boron Carbons
 Wire Wound Precisions IRCAL Tru-Mites

Name _____

Company _____

Address _____

City _____ State _____

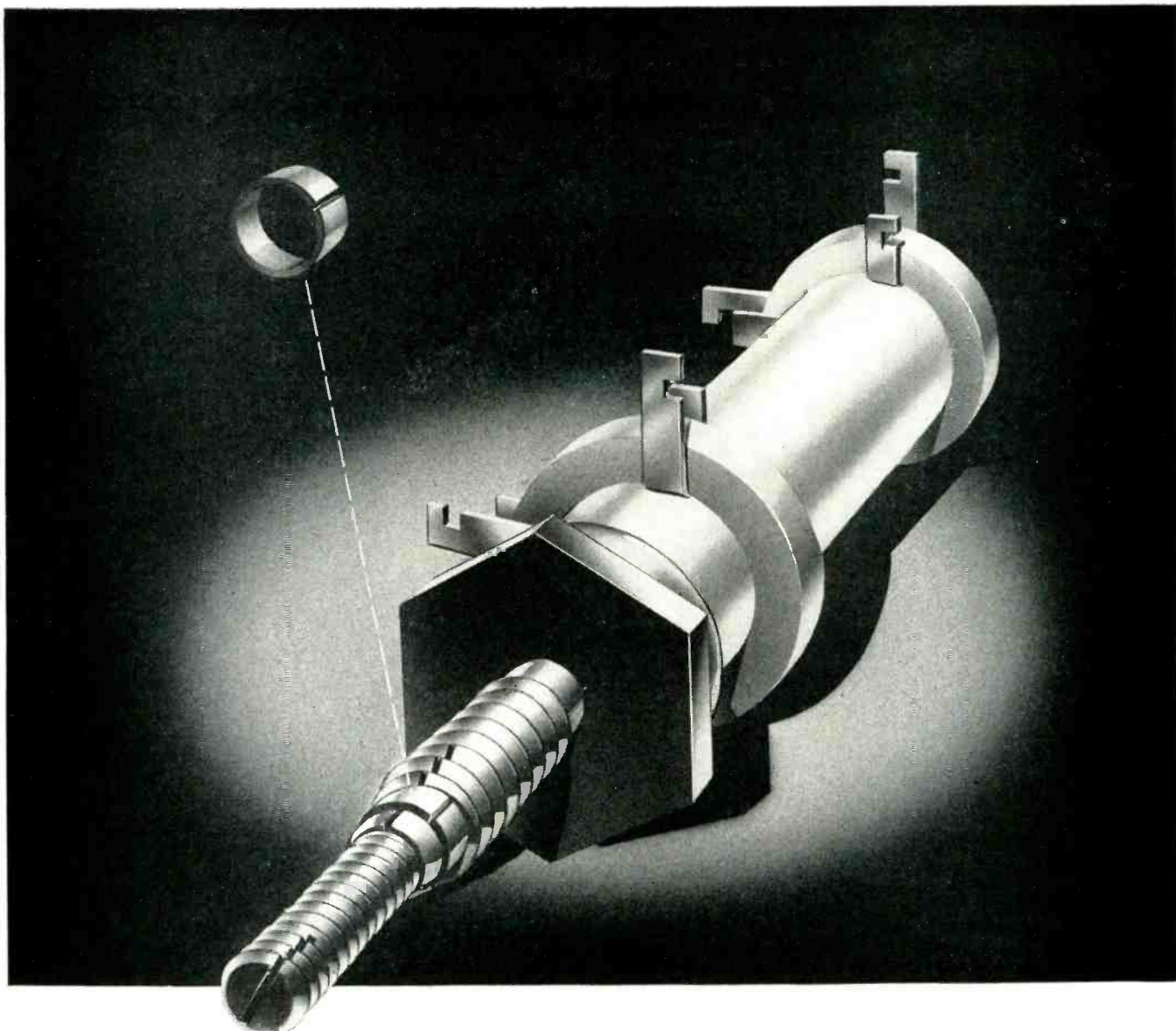

Always tense but never tired

Again CTC comes up with an advancement for more secure, more effective electronic assemblies. It's the new Perma-Torq* constant tensioning device for tuning cores of standard CTC ceramic coil forms.

CTC's Perma-Torq, a compression spring of heat treated beryllium copper, has very high resistance to fatigue and keeps coils tuned as set, under extreme shock and vibration. It allows for immediate readjustment without removal or loosening of any mounting nut or locking spring. But most important of all — Perma-Torq like all CTC components is *quality controlled*.

CTC's *quality-control* means you get consistent top quality components. Each step of production is checked, each component part — even though already certified — is checked again. And finally CTC's finished product is checked. That's why CTC can offer you a guaranteed electronic component — standard or custom — whose performance you can depend upon.

CTC researchers and practical experts are always available to help solve

your components problems. For samples, specifications and prices write to Sales Engineering Dept., Cambridge Thermionic Corporation, 437 Concord Ave., Cambridge 38, Mass. On the West Coast contact E. V. Roberts, 5068 West Washington Blvd., Los Angeles 16 or 988 Market St., San Francisco, Cal.

NEW PERMA-TORQ UNITS come completely factory assembled to mounting studs, eliminating the bother of assembling and adjusting separate locking springs. CTC coil forms with Perma-Torq Tensioning Device are designated PLST, PLS5, PLS6 and PLS7, are completely interchangeable with the LST, LS5, LS6 and LS7 series, and are available at no increase in price.

*Patent pending

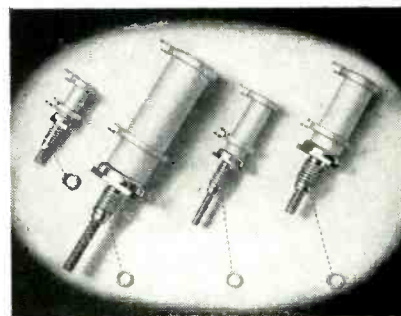

CTC

CAMBRIDGE THERMIONIC CORPORATION

*makers of guaranteed electronic components
custom or standard*

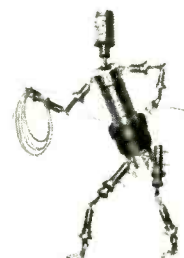

1. POTENT POWER +

Up to 5100 mmf at 300 vDCw
Up to 3900 mmf at 500 vDCw

2. SMALL SIZE

(size) Length 3/4"
average Width 7/16"
average Thickness 3/16"
DM-20 shown actual size

El-Menco Dur-Mica DM-20

DIPPED MICA CAPACITOR WITH PARALLEL LEADS

3. PEAK PERFORMANCE

ideal for new miniaturized designs and printed wiring circuits

MEETS ALL HUMIDITY, TEMPERATURE AND ELECTRICAL REQUIREMENTS OF

MIL-C-5 Specifications!

TEST IT AND COMPARE!

- El-Menco's Dur-Mica DM20 costs even less than our famous molded mica capacitors.
- Provides greater versatility — wider applications.
- Tougher phenolic casing assures longer-life and greater stability through wide ranges in temperature.
- Parallel leads simplify application in transistor and sub-miniature electronic equipment including printed circuits for military and civilian use.

For Extreme Miniaturization Use Our DM15

DM15 — Up to 510 mmf at 300 vDCw
Up to 400 mmf at 500 vDCw

Available in 125°C operating temperature. Minimum capacity tolerance available $\pm 1/2\%$ or 0.5 mmf (whichever is greater).



to meet modern miniature requirements

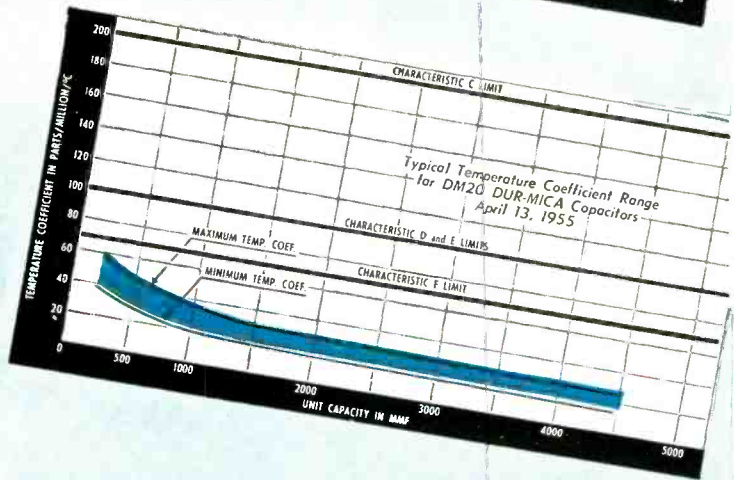
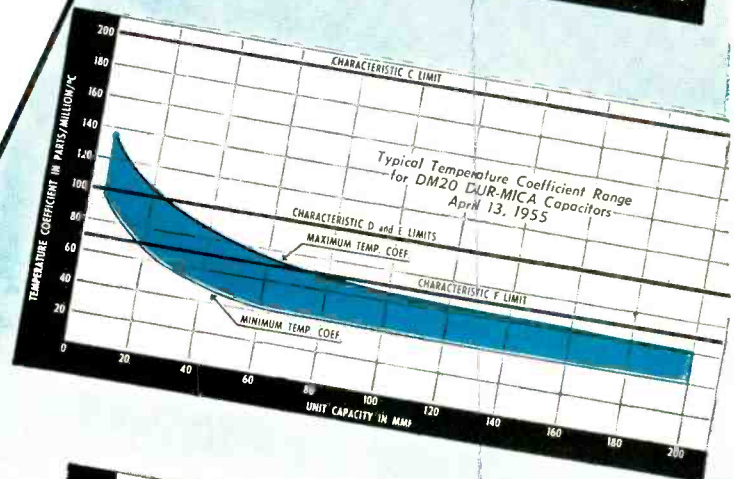
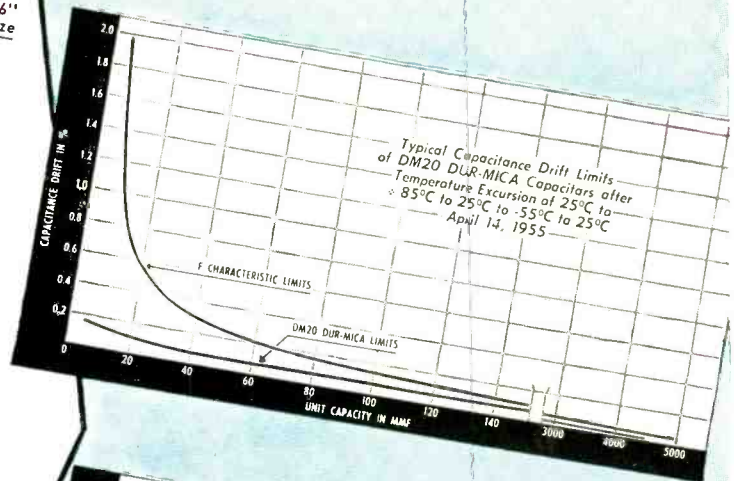

For your special requirements — we are pleased to offer information and assistance. Write for free samples and catalog on your firm's letterhead.

THE ELECTRO MOTIVE MFG. CO., INC.

WILLIMANTIC CONNECTICUT

- molded mica • mica trimmer
- tubular paper • ceramic

Arco Electronics, Inc., 103 Lafayette St., New York, N. Y.
Exclusive Supplier To Jobbers and Dealers in the U.S. and Canada



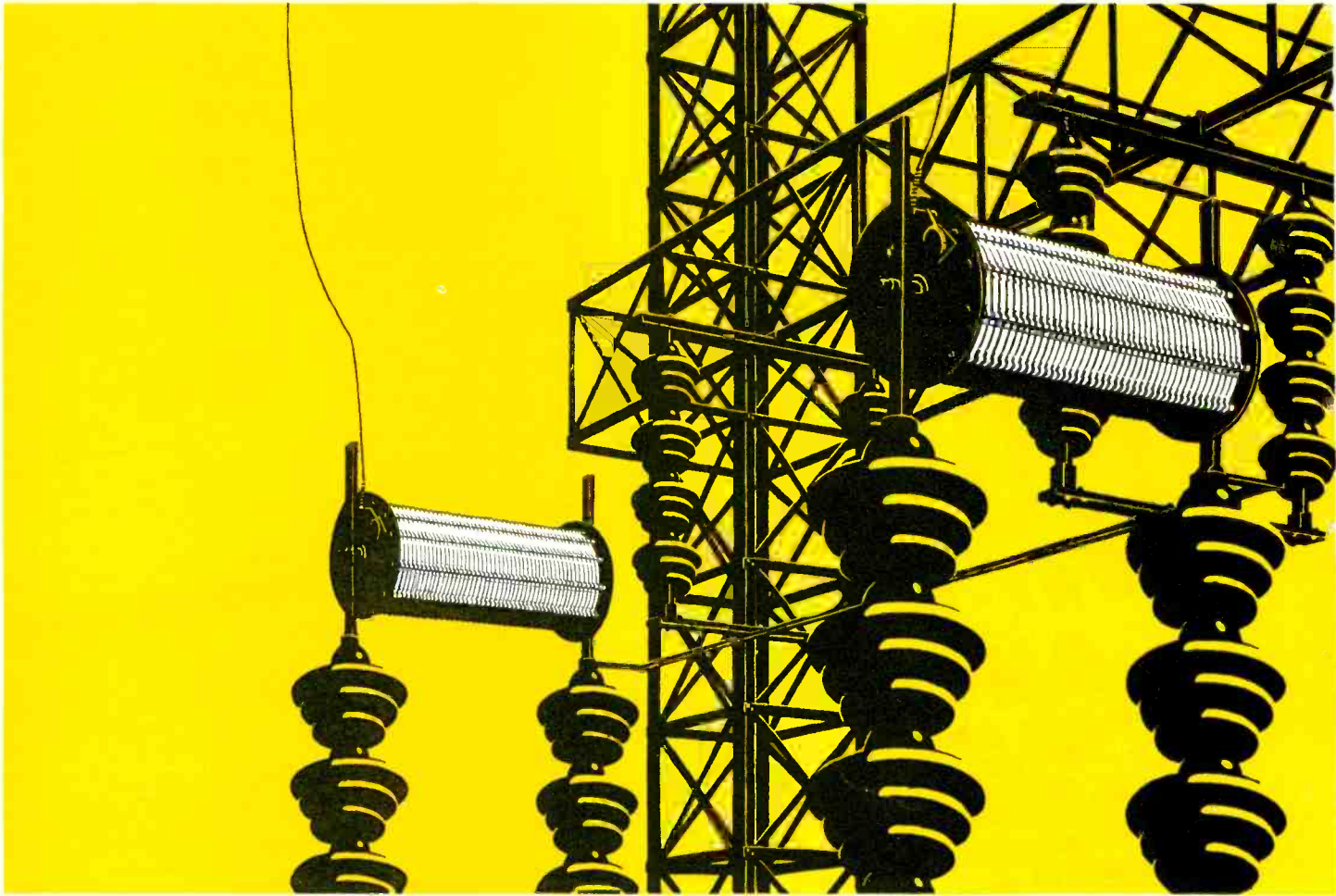

General Electric solves a tough insulating

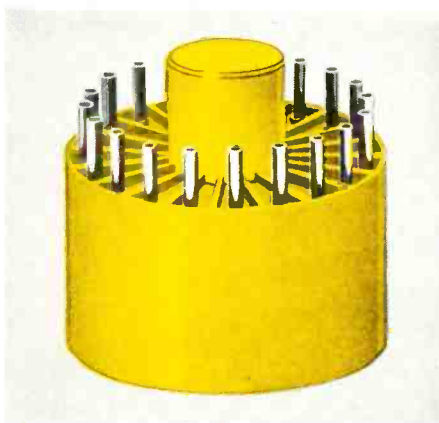

1 Because of its outstanding dielectric strength and arc resistance, mineral-filled PLASKON Alkyd was selected by R.C.A. for television picture tube bases. Under a test potential of 12,000 volts, electrical leakage between the pins is so low as to be negligible.

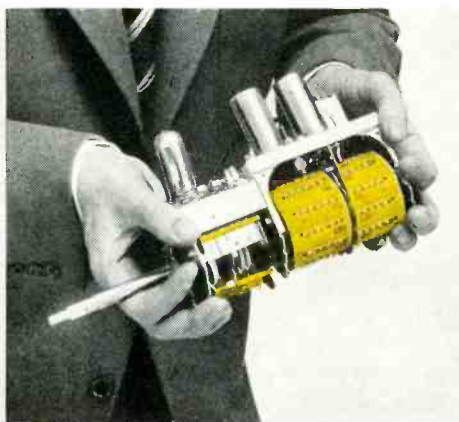

2 Rapid molding characteristics, plus excellent dimensional stability and electrical properties, are the reasons why mineral-filled PLASKON Alkyd continues to be used by Standard Coil Products Co., Inc. for TV tuner segments.

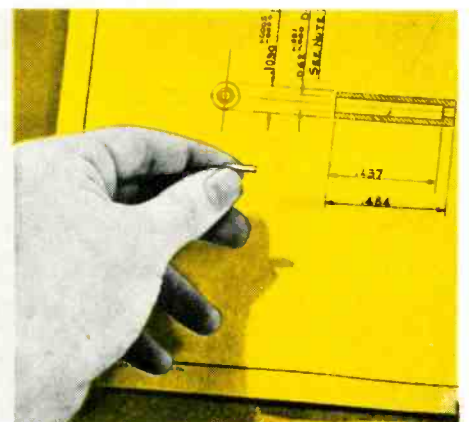

3 This precision spring holder by Mason, Shaver & Rhoades is molded to extremely close tolerances, (as little as .0005") through the use of glass-reinforced PLASKON Alkyd. Only this material had sufficient strength in thin sections to meet their requirements.

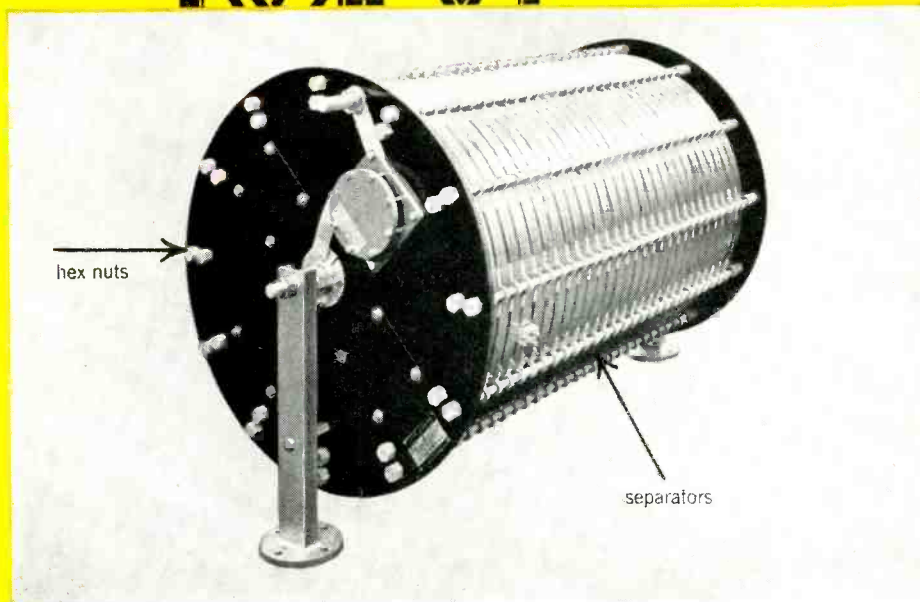

problem with **PLASKON**[®] alkyd

Here is another instance where PLASKON Alkyd was given a difficult . . . and highly specialized job to do, and succeeded with flying colors. General Electric needed a versatile, insulating material for separators between turns of carrier current line trap coils, and for nuts to bolt the line traps together.

Glass-reinforced PLASKON Alkyd Molding Compound was selected for both because it met all the specifications of physical and electrical endurance required. Alkyd has great resistance to arcing and leaking under high voltage, and when reinforced with glass, has extraordinary compressive, flexural and impact strength as well. It is self-extinguishing, has exceptional dimensional stability and is resistant to weathering.

The demand by industry and the military for a plastic to meet exacting requirements and offer mass production economies has made PLASKON Alkyd an obvious essential in today's specialized and highly advanced end-products. Have you investigated the unlimited possibilities of alkyd for your products? Why not call your local Plaskon man for complete information.



For further information on PLASKON Plastics and Resins, address BARRETT DIVISION, Allied Chemical & Dye Corporation, Dept. 15 K, 40 Rector St., N. Y. 6, N. Y. HANOVER 2-7300

LAMBDA again is the FIRST CHOICE of engineers who specify POWER SUPPLIES

Once again, Lambda Power Supplies have been rated in top position by engineers in the electronics and allied industries.

Engineers know on the basis of their own experience as well as their observation in other plants that Lambda Power Supplies are *precision* equipment, dependable and built for heavy duty.

The Lambda catalog offers a greater variety of power supply models than ever before.

Stock units are available that can handle almost any electrical or mechanical situation. Where circumstances require, units also may be modified quickly and inexpensively.

Send for your copy of the comprehensive *Lambda Catalog of Power Supplies for Laboratory and Industry*. If you have a special power supply problem, we will be glad to make recommendations.



LAMBDA OPENS MOST MODERN PLANT...DEVOTED EXCLUSIVELY TO POWER SUPPLIES

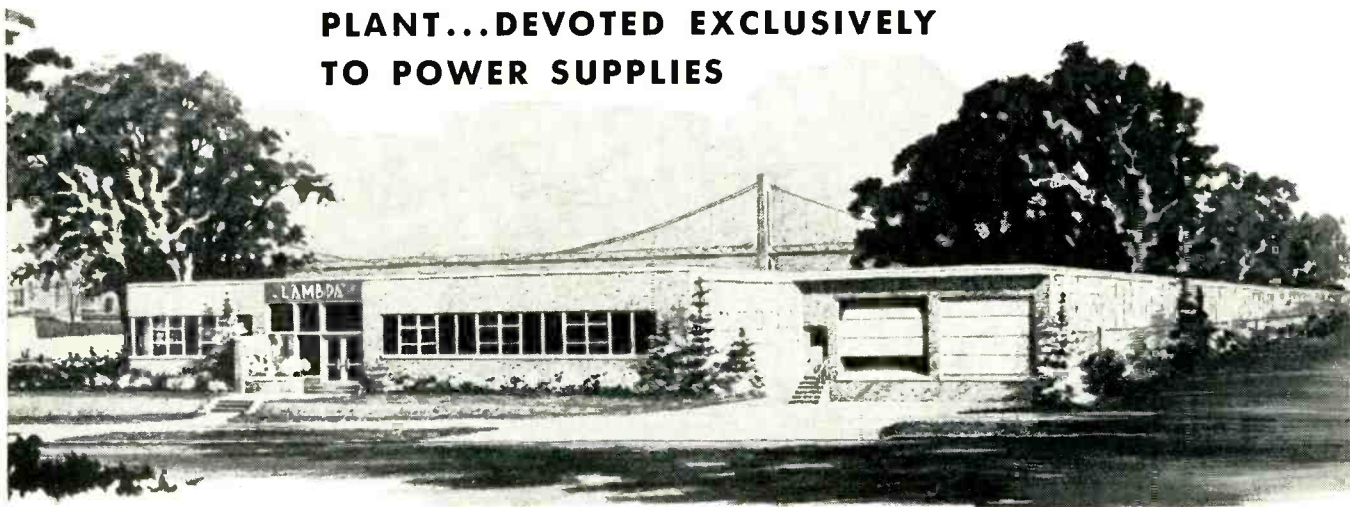

To meet the record demand for precision-engineered, factory-assembled power supplies, Lambda has constructed this new manufacturing plant at College Point, New York. The substantial increase in production capacity permits Lambda to ship models from stock under ordinary conditions; assures you of quick delivery.



LAMBDA Electronics Corp.

FIRST in Preference • FIRST in Quality • FIRST in Sales

11-11 131 STREET, COLLEGE POINT 56, NEW YORK

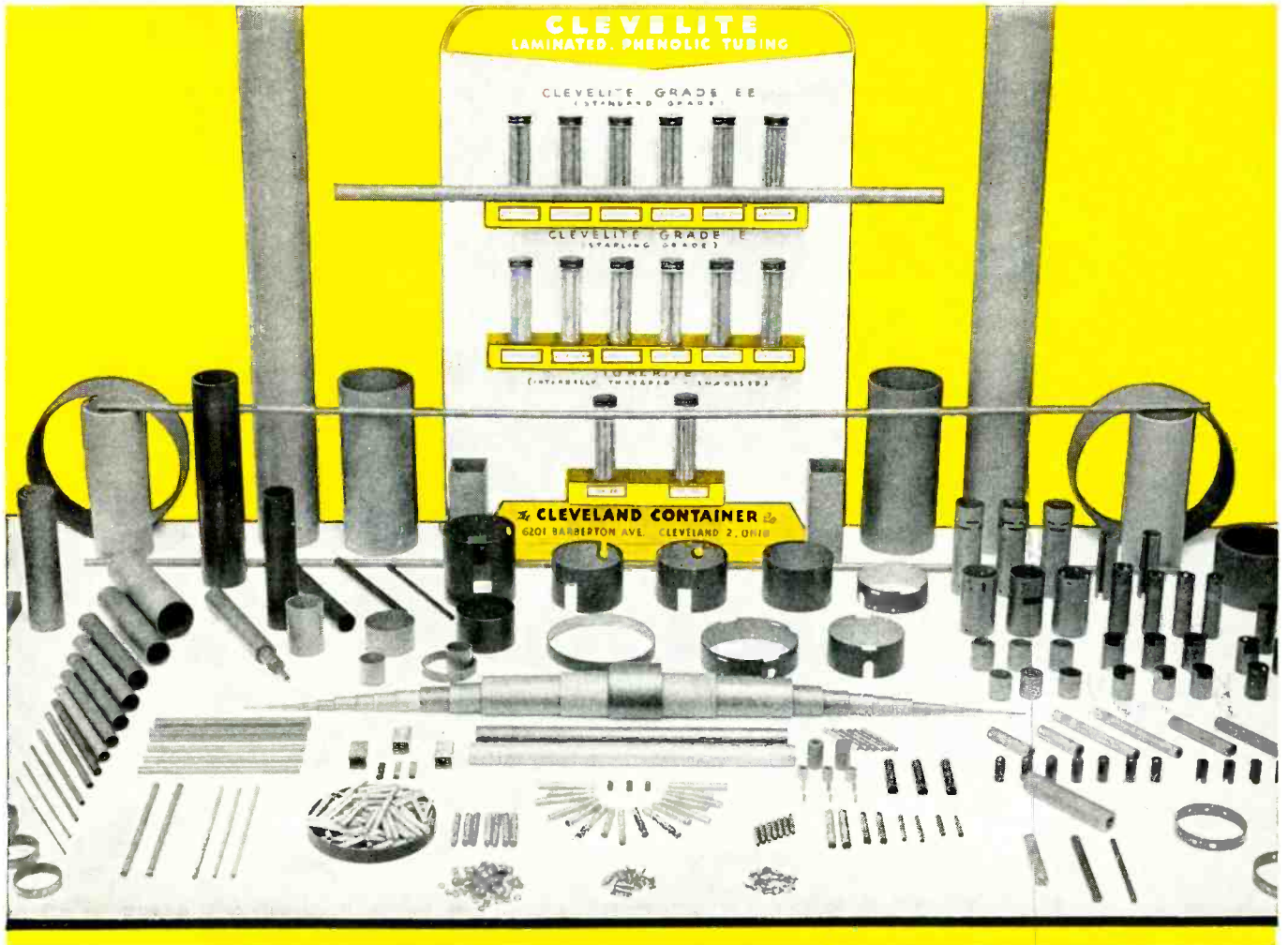

TORKRITE

. . . newly improved
. . . and at lower prices.

This fine internally threaded and embossed tubing is now made to fit 8/32, 10/32, 1/4-28, 5/16-24, and 5/16-28 cores.



INVESTIGATE
this outstanding
coil form!



*Reg. U. S. Pat. Off.

CLEVELITE* FOR EVERY USE

It possesses excellent electrical insulation properties, has good machinability, and is highly resistant to moisture.

Clevelite is structurally strong, very light and may be easily punched, machined or sawed . . . certain tough grades may be cold punched satisfactorily.

Clevelite chemical properties are also exceptional . . . unaffected by solvents and oils . . . resistant to normal strength basic, acidic, and salt solutions.

Write for folder detailing the seven grades in which CLEVELITE is produced.

Why pay more? For Good Quality . . . call CLEVELAND!

THE
CLEVELAND CONTAINER
COMPANY

6201 BARBERTON AVE. CLEVELAND 2, OHIO

PLANTS AND SALES OFFICES:

CHICAGO • DETROIT • MEMPHIS • PLYMOUTH, WIS. • OGDENSBURG, N.Y. • JAMESBURG, N.J. • LOS ANGELES

ABRASIVE DIVISION at CLEVELAND, OHIO
Cleveland Container Canada, Ltd., Prescott and Toronto, Ont.



Representatives:

NEW YORK AREA: R. T. MURRAY, 604 CENTRAL AVE., EAST ORANGE, N. J.
NEW ENGLAND: R. S. PETTIGREW & CO., 62 LA SALLE RD., WEST HARTFORD, CONN.
CHICAGO AREA: PLASTIC TUBING SALES, 5215 N. RAVENSWOOD AVE., CHICAGO
WEST COAST: IRV. M. COCHRANE CO., 408 S. ALVARADO ST., LOS ANGELES

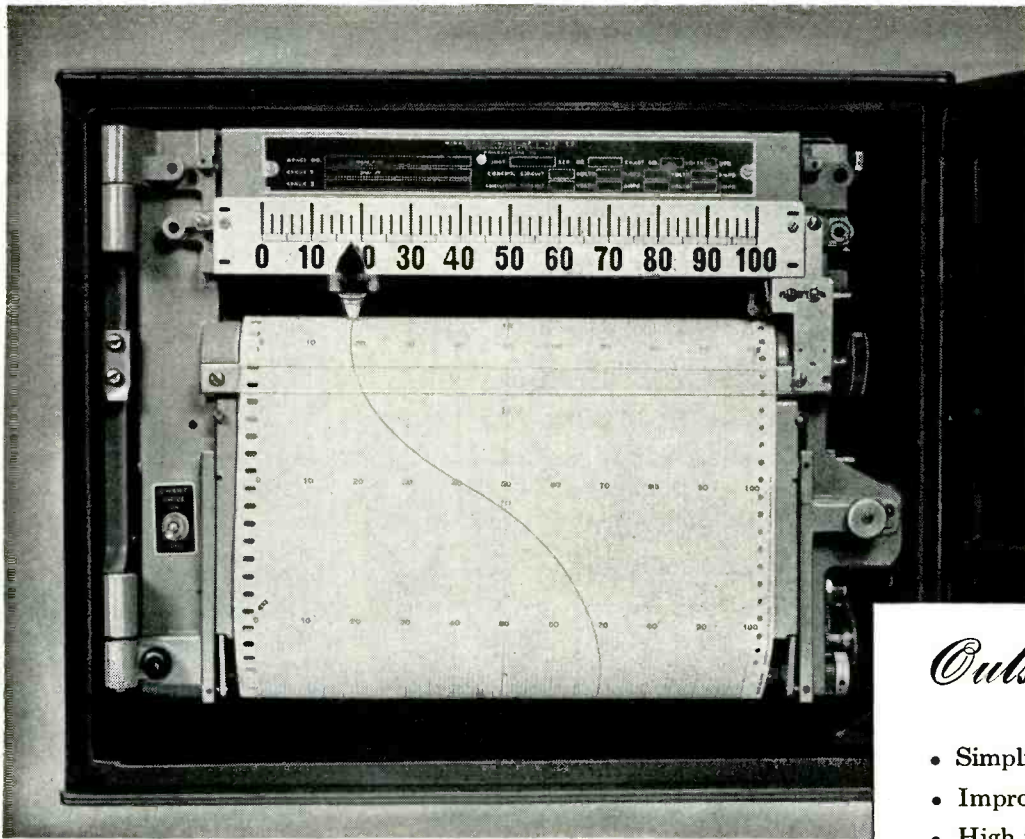

Outstanding

NEW FEATURES

- Simplified design
- Improved damping
- High input impedance
- Continuous standardization

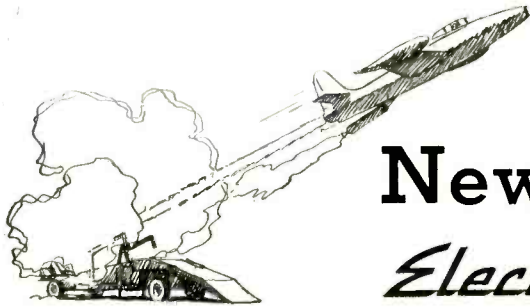

New $\frac{1}{4}$ -second *Elektronik* recorder

follows fast-changing variables with split-second response

Designed to meet the special data-recording requirements of experimental stations, laboratories, and research centers, the new $\frac{1}{4}$ -Second Pen Speed *Elektronik* Recorder fills an important gap between conventional large-chart recorders and oscillographic instruments.

This new *Elektronik* Recorder is the *fastest* large-chart instrument available today . . . the perfect solution for high-speed plotting of any function that can be reduced to a d-c millivolt signal. It offers the investigator extreme sensitivity, complete flexibility, laboratory precision . . . plus many *new* features the research man will appreciate:

Easy range change—All components of the potentiometer bridge are located on an interchangeable bakelite card.

New design plug-in amplifier—has many times the power output of standard units . . . features high input impedance, easy accessibility, flexible gain control, and rugged construction.

New pen and carriage designs—prevent pen clogging and paper tearing. Ball point pen easily removed. Transparent cartridge shows ink supply.

New slidewire and contacts—Designed for long life under high speed operation.

Your nearby Honeywell sales engineer will be glad to discuss applications in your research work . . . and he's as near as your phone.

MINNEAPOLIS-HONEYWELL REGULATOR CO.,
Industrial Division, Wayne and Windrim Avenues,
Philadelphia 44, Pa.—in Canada, Toronto 17,
Ontario.

● REFERENCE DATA:

Write for Instrument Data Sheet No. 10.0-21
“ $\frac{1}{4}$ -Second Pen Speed *Elektronik* Recorder.”



MINNEAPOLIS
Honeywell

BROWN INSTRUMENTS

First in Controls

FILTRON

HIGH ATTENUATION • CONTINUOUS DUTY • HERMETICALLY SEALED

SCREEN ROOM FILTERS



FILTRON TYPE FSR-502
500 VAC/DC
100 AMPS
Frequency Range 1000 to 15,000 MC

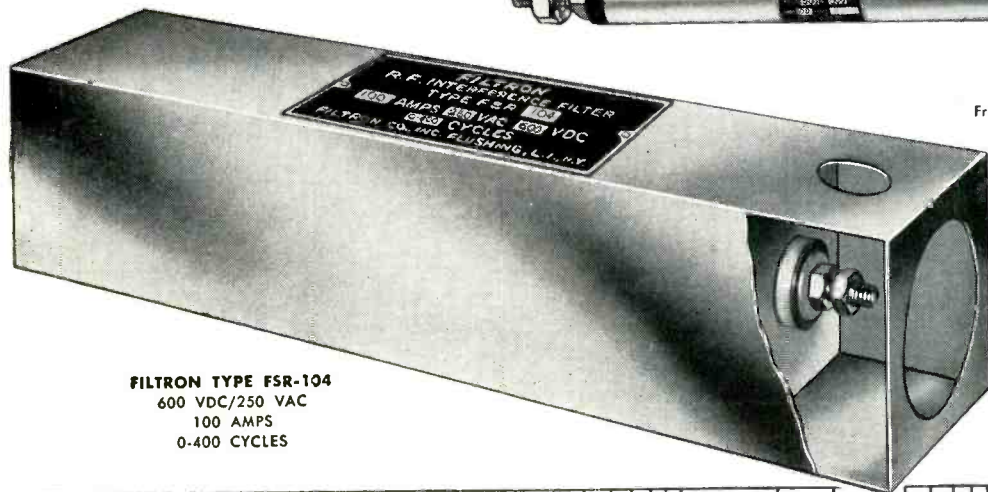

FILTRON TYPE FSR-104
600 VDC/250 VAC
100 AMPS
0-400 CYCLES

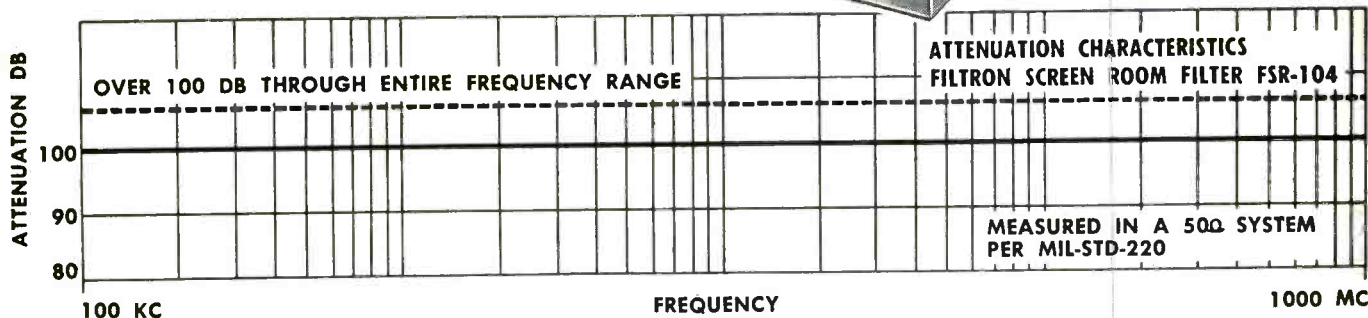

JUST OFF THE PRESS—Write for your copy

RADIO INTERFERENCE FILTER CATALOG

This 20 page catalog contains valuable data on FILTRON RADIO INTERFERENCE FILTERS for SCREEN ROOMS, INDUCTION HEATING EQUIPMENT, DIATHERMY SETS, X-RAY UNITS and other electrical interference-producing equipment. Included are illustrated installation recommendations, essential information on applications, attenuation characteristics and mechanical dimensions... Your copy gladly sent free upon request.

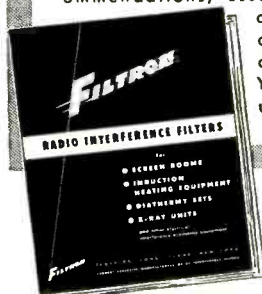

Screen room manufacturers specify and install FILTRON Screen Room Filters as standard equipment.

FILTRON Screen Room Filters are used in the majority of industrial, government and military screen rooms, to meet the requirements of specification MIL-S-4957, and wherever critical RF measurements are required.

FILTRON has over 40 types of Screen Room Filters available, ranging from 1 Amp to 1000 Amps, 28 VDC to 500 Volt AC/DC, 0 to 1000 cycles. Complete technical information available.

FILTRON RF Interference Filters are also specified in the latest types of Radar, Radio Transmitters, Receivers, Motor Generator Sets, Inverters, Aircraft, Electronic Systems, and numerous other "restricted" equipments.

When you have an RF Interference Filter problem, consult FILTRON—the most dependable name in RF Interference Filters.

SALES REPRESENTATIVES

G. S. Marshall Co., Pasadena, Cal.
Redwood City, Cal.

J. Kent Thompson, Maple Heights, Ohio
Myron P. Roebuck, Wright Field,
Dayton, Ohio

Strauss-Whitmore, Inc., Chicago, Ill.
S. Sterling Company, Detroit, Mich.

R-O-R Associates, Ltd., Toronto, Can.
Montreal, Can.

Holliday-Hathaway Co., Inc., Sales Offices
at: Canaan, Conn., Cambridge, Mass., New
York, N. Y., Great Neck, N. Y., Rochester,
N. Y., Binghamton, N. Y., Wood-Ridge,
N. J., Winston-Salem, N. C.

An inquiry on your Company letterhead will receive prompt attention

FILTRON CO., INC., FLUSHING, LONG ISLAND, NEW YORK
PLANTS IN FLUSHING, NEW YORK, AND LOS ANGELES, CALIFORNIA

Radar

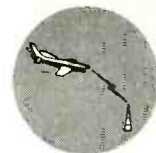
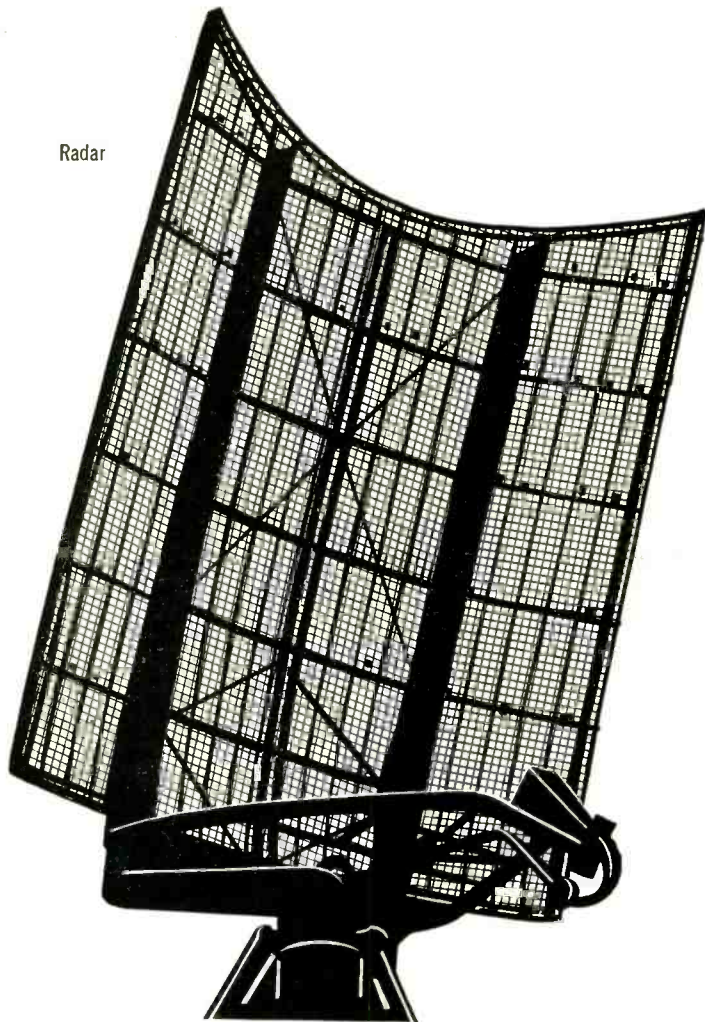

Navigation

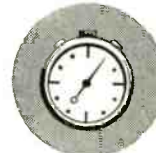

Timing

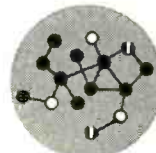

Nucleonics

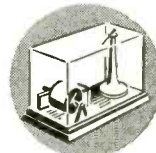

Geophysics

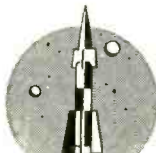

Ordnance

PRECISION DIGITAL DELAY GENERATOR

FOR GENERAL-PURPOSE LABORATORY USE

Generates pulses accurately spaced in time with respect to an internally generated reference pulse—range 0 to 100,000 microseconds

Complete generality permits numerous and varied uses such as radar range calibration, target simulation, generation of secondary frequency standards, elapsed time measurements, phase measurements, etc. Fields of application include Radar, Navigation, Telemetry, Nuclear Studies, Computer Research, Geophysics, Ordnance, and any other fields in which timing is significant.

The ability to generate a specific delay at accurate variable repetition rates sets this instrument apart from any other pulse or delay generator in the field today. Write for full details.

Pulses can be supplied under either one-shot conditions or at variable repetition rates. Both pulse delay and repetition period can be established in increments as small as 1 microsecond.

The repetition period can also be externally triggered, in which case two inde-

pendently variable delayed pulses are available. Accuracy of both repetition period and pulse delay are held to one part in 10^6 by the thermostatically controlled crystal oscillator. The digital circuitry and the built-in self-checking features make continuous calibration unnecessary.

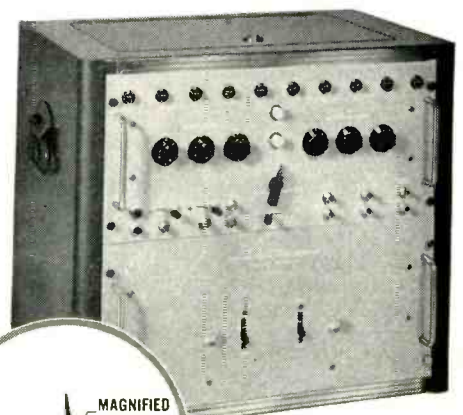

MODEL 743

Observed pulse as viewed on a suitable synchroscope

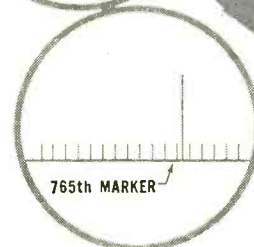
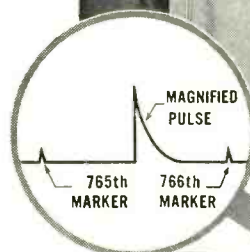

KAISER METAL PRODUCTS, INC.
BRISTOL, PA.

**now
available**

**NEW Consolidated Data Booklets
for Raytheon Magnetrons,
Klystrons and Special Tubes**

WRITE FOR YOUR COPIES

These valuable free data booklets, which we will be glad to send you, list most of the principal unclassified types manufactured. They give maximum ratings, typical operating values, frequency ranges, and power levels. Indispensable to every engineer's file.

Raytheon is the world's largest producer of CW and pulse magnetrons, available in either fixed or tunable designs. A compact, efficient source of microwave power, magnetrons are being used in a growing number of applications.

Raytheon klystrons, which can be tuned mechanically or thermally, fit the widest range of requirements from 550 to 60,000 Mc.

The special tubes include backward wave oscillators, square law tubes, storage tubes and others.

Write today for your data booklets—or telephone Waltham 5-5860. There is no obligation, of course.

*Excellence in
Electronics*



**RAYTHEON MANUFACTURING
COMPANY**

**Microwave and Power Tube Operations,
Section PT-27, Waltham 54, Mass.**

Raytheon makes: Magnetrons and Klystrons, Backward Wave Oscillators, Traveling Wave Tubes, Storage Tubes, Power Tubes, Receiving Tubes, Transistors



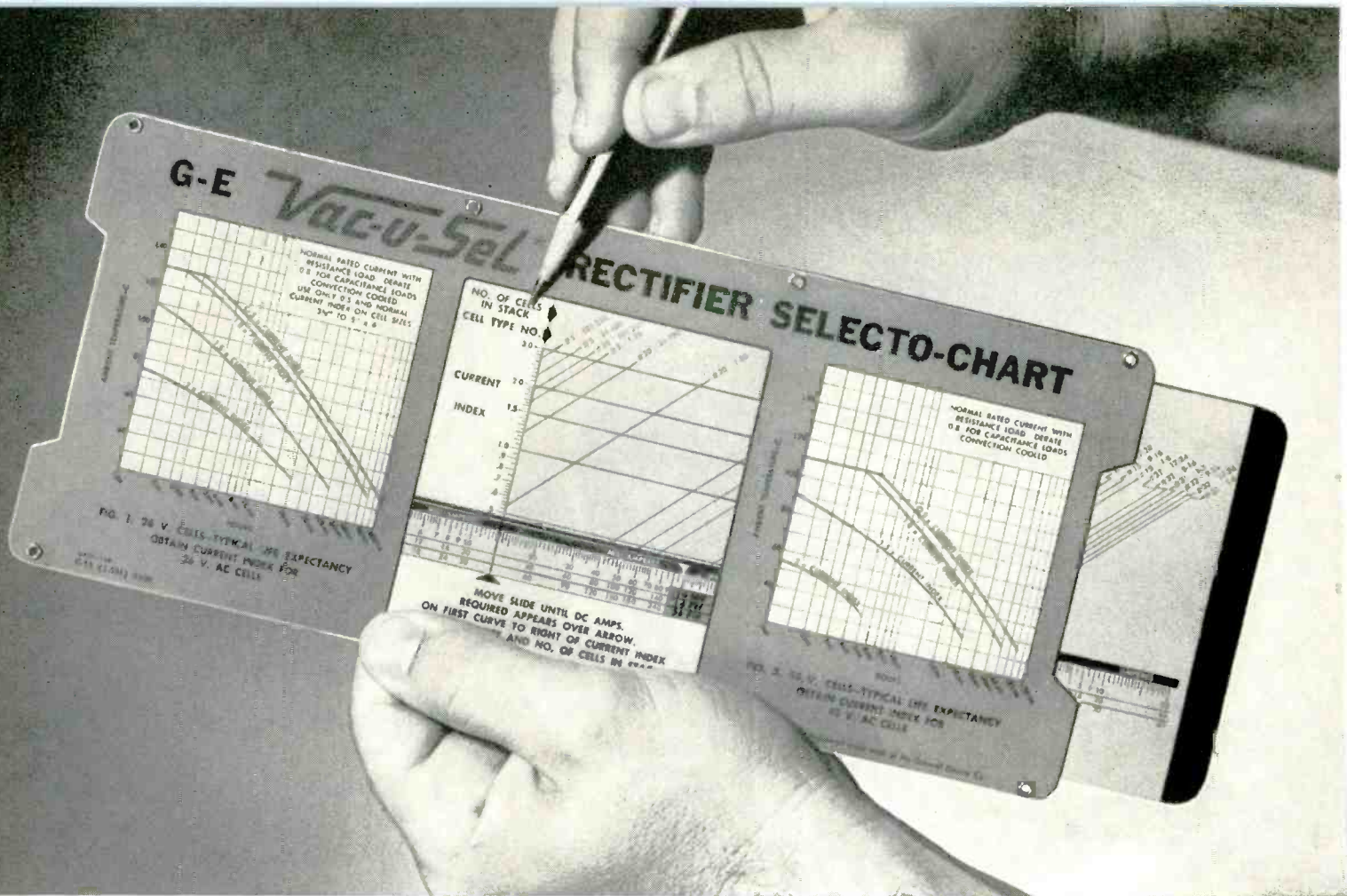

THIS G-E DESIGNED SELECTO-CHART, KEY TO THE NEW APPLICATION APPROACH, COMPUTES EXACT VAC-U-SEL RECTIFIER STACK YOU NEED.

NEW G-E APPLICATION APPROACH CUTS DESIGN TIME . . .

The Exact *Vac-u-Sel** Rectifier You Need Can Now Be Chosen in Minutes . . . On-the-spot

This new application approach, recently developed by General Electric, assures you of getting the correct Vac-u-Sel rectifier to meet your exact requirements. Now you are assured of getting the full advantage from the long life and outstanding technical characteristics inherent in all the many sizes and types of Vac-u-Sel rectifiers. In addition, in practically all cases, the sales engineer can give you the exact identification and price of your stack on the spot, without the inconvenient delay involved in getting data from the factory.

THIS NEW APPLICATION APPROACH brings top quality to your products by permitting complete and efficient utilization of the outstanding electrical characteristics, dependability, and predictable operation found in the many sizes, housings, finishes, and ratings of Vac-u-Sel component rectifiers.

FOR MORE INFORMATION on this new application approach, or the outstanding Vac-u-Sel line of rectifiers, contact your nearest G-E Apparatus Sales Office, or write Section 461-38, General Electric Co., Schenectady 5, N. Y.



G-E SALES ENGINEERS are able to determine, on the spot, the exact Vac-u-Sel stack to suit your particular application.

*Reg. Trade-mark of General Electric Co.

GENERAL  **ELECTRIC**

Want more information? Use post card on last page.

Here's an exciting new development in metallized ceramics!

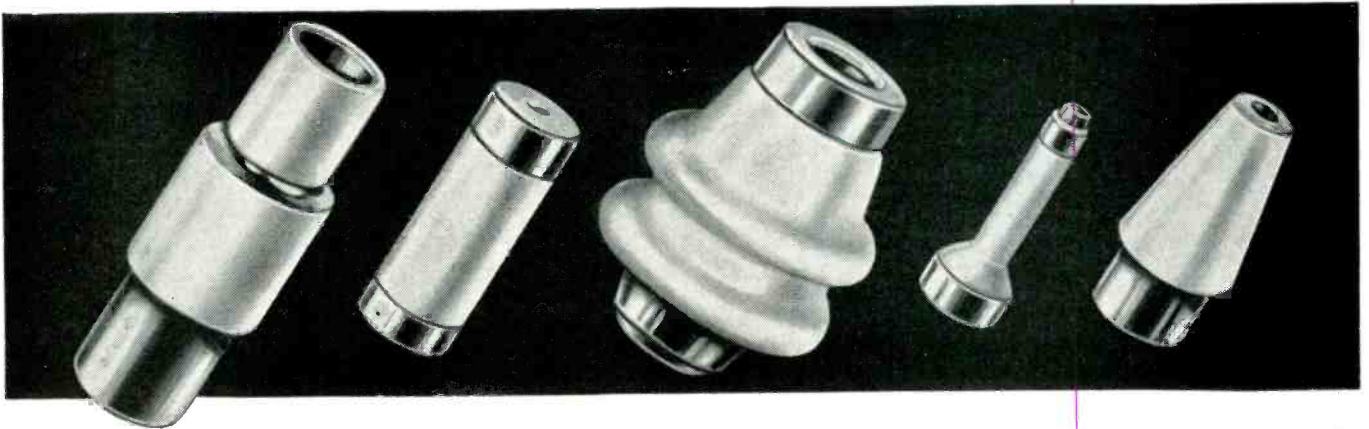

NICOTE METALLIZED CERAMIC COATING for use with both hard and soft solders!

Here is Frenchtown's revolutionary answer to a problem that has baffled industry for years . . . a satisfactory *single* metallic coating for refractory ceramic bodies which provides a surface for applying solders with melting points between 275° and 1600°.

NICOTE, applied to refractory ceramic bodies by high temperature firing, in most applications requires no expensive preliminary processing such as buffing, electroplating, or tinning to form a strong, firmly-adhering bond with either *hard* or *soft* solders.

Whether the problem requires the fastening of a metal part or other metallized ceramic parts to its surface, NICOTE offers distinct

advantages over ordinary silver soft receptive coatings as well as molybdenum and tungsten hard solder coatings. It will withstand molten soft soldering *indefinitely* . . . it's less costly to produce . . . requires no expensive processing.

NICOTE'S mechanical bond to the refractory ceramic body approximates ceramic strength, making it ideal for hermetic seals, high strength mechanical seals, and vacuum type applications.

Like to know more about the amazing possibilities of NICOTE Metallized Ceramic Coating for your product? Bulletin 155 contains complete engineering details. Write for a free copy today. There's no obligation, of course.

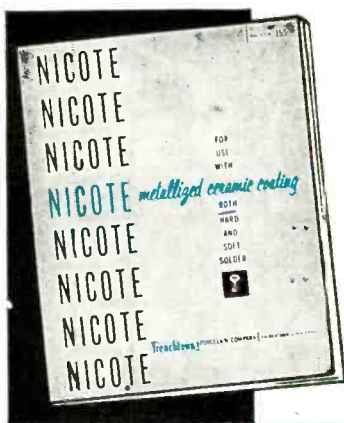

This idea starter is free for the asking . . . contains complete facts and details about NICOTE . . . Frenchtown's new *single* metallic coating for use with both hard and soft solders. Ask for Bulletin 155.

frenchtown PORCELAIN COMPANY

86 MUIRHEAD AVENUE | TRENTON 9, NEW JERSEY

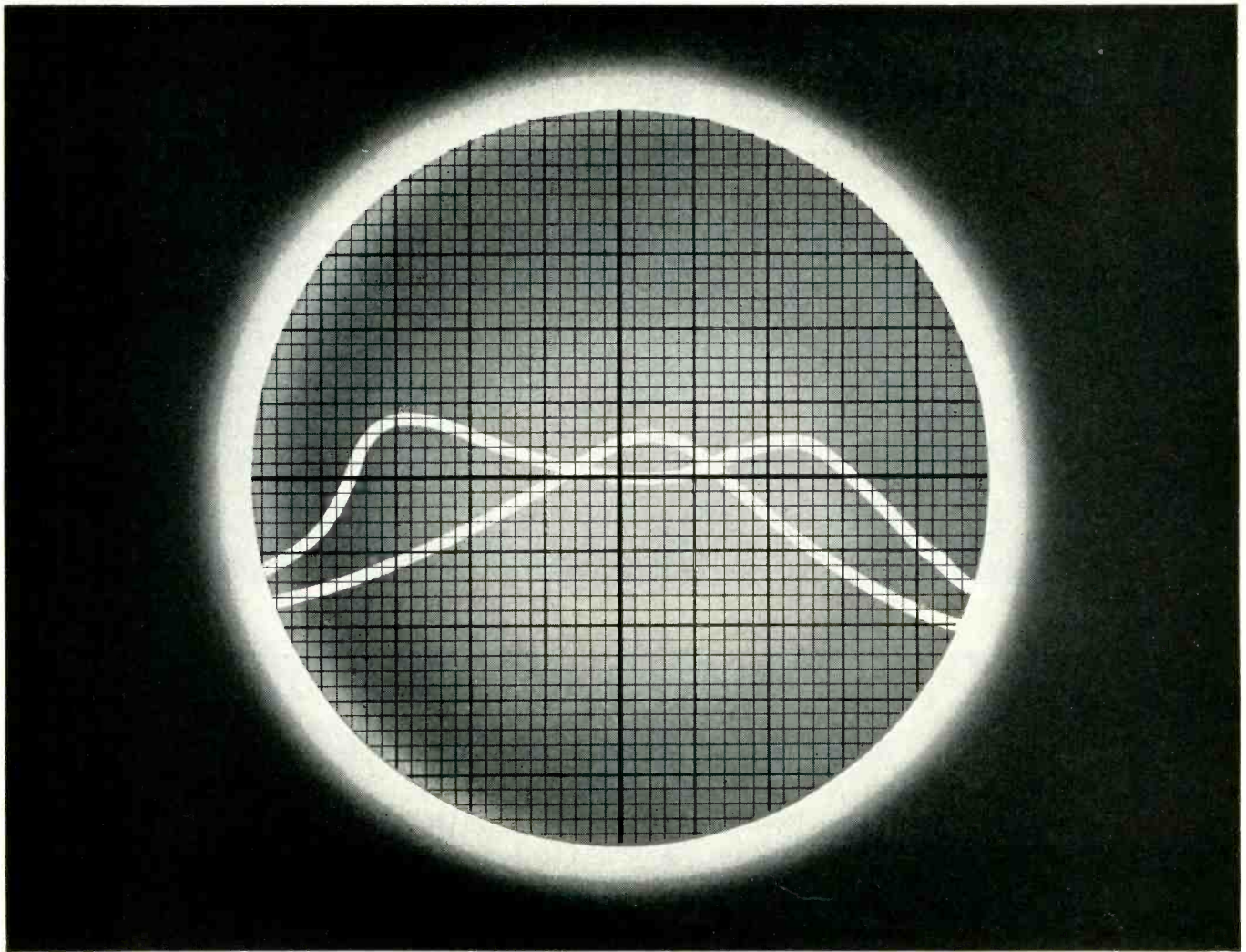

how can vacuum-melted metals help the electronics industry?

When a metal is melted and cast in a vacuum, the gaseous impurities are literally sucked out. The result is an important improvement in many critical properties.

For example, cathode nickel alloys, iron, and alloys for metal-glass seals — are all produced to extremely close standards of composition and uniformity. Soft magnetic alloys exhibit improved permeability, both initial and saturation. Copper shows marked increase in purity and soundness.

Vacuum-melted components greatly increase

vacuum tube life and reliability. That's because the vacuum-melting process degasses these metals *before they are placed in the tube.*

Vacuum Metals Corporation, pioneer in development and leading producer of vacuum-melted metals and alloys, can now offer you a wide range of metals for electrical or electronic applications. If you would like to see how these remarkable new materials can fit into your own production, write on your company letterhead, describing the application in which you are interested. *Vacuum Metals Corporation, P.O. Box 977, Syracuse 1, New York.*



VACUUM METALS CORPORATION

Jointly owned by Crucible Steel Company of America and National Research Corporation

Out of this world

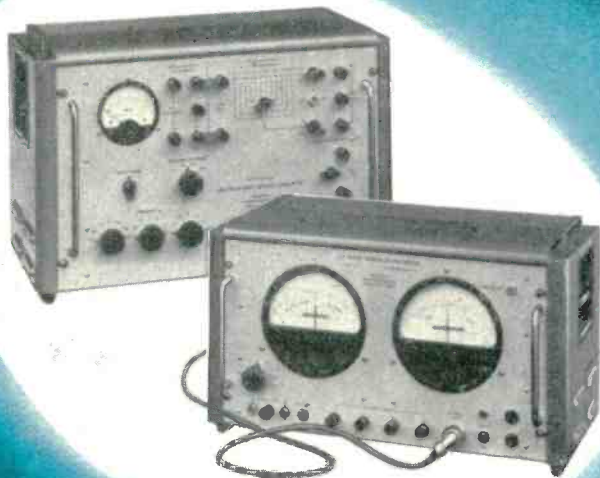

...but within your reach !

- ★ Tests AC, DC or carrier servos
- ★ Plots high accuracy Nyquist diagrams
- ★ Covers 0.1 c/s to 1,000 c/s
- ★ Independent of harmonics, noise & spurious frequencies
- ★ Answers G.M., fire-control, simulator, computer, vibration, magamp and all servo problems

For servo design and testing, the Solartron Transfer Function Analyser really is "out of this world".

G.M. manufacturers everywhere are getting way ahead, and every mail brings reports of new applications for which the T.F.A. has proved ideal. Cable Solartron if you want our engineer to give you a demonstration, or write for fullest information.

The world's foremost servo test equipment by

THE SOLARTRON ELECTRONIC GROUP LTD.

Cables: Solartron, Thames Ditton.

Thames Ditton, Surrey, England.

Telephone EMBerbrook 5522.

**Original
equipment
for over
seven years!**



**Radio Receptor
Selenium
Rectifiers**

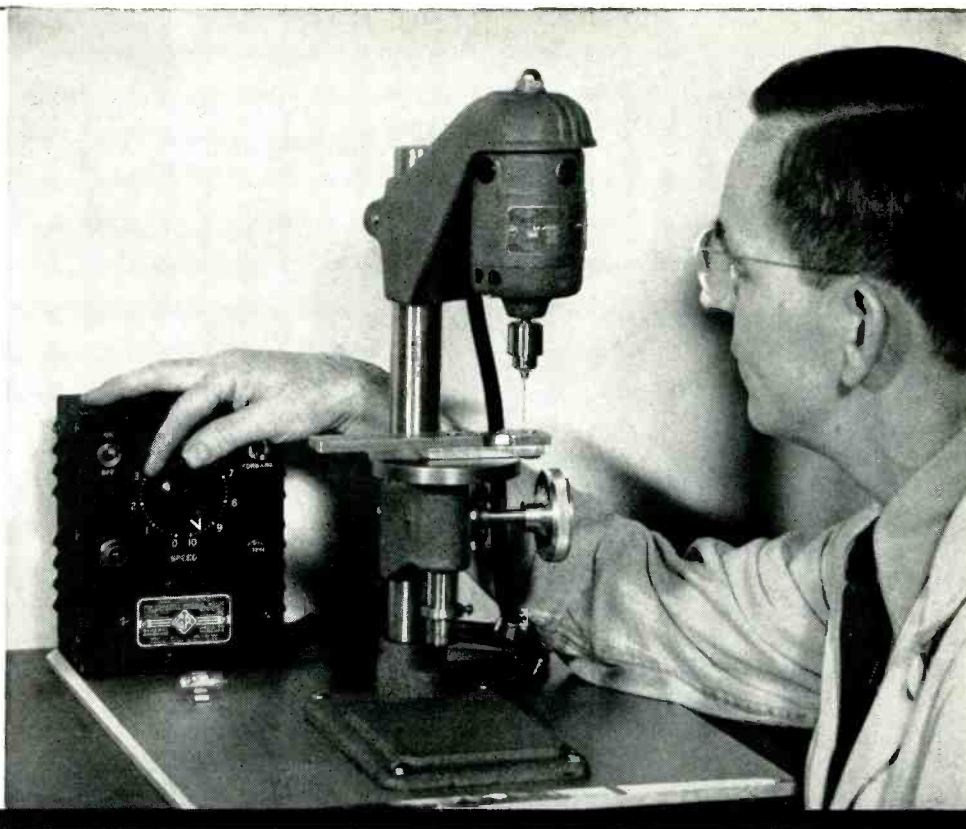

*....Deliver Top Performance in
Variac Motor Speed Controls*

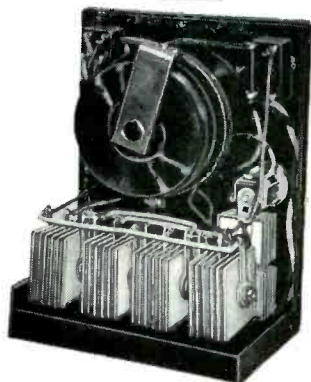

One of General Radio's Variac Motor Speed Controls showing a typical application of Radio Receptor Selenium Rectifiers. Six RRco. units are employed here.

Back in 1948, General Radio Co. of Cambridge, Mass. posed tough rectification problems to us involving their compact new Variac Motor Speed Controls. Working closely with their engineers then and since we have come up with the answers. As a result, Radio Receptor rectifiers have successfully been used in units rated at 1/15, 1/6 and 1/3 hp for field and armature supplies.

General Radio tells us that year after year *for seven years* the service record of these Radio Receptor rectifiers has proved they are worthy components of a fine product — that they are long lived and really reliable in constant use in many diversified applications.

You see, it pays to talk to Radio Receptor specialists when the circuit calls for rectifiers. We'll gladly offer practical suggestions concerning *your* problem, too. Write us now!

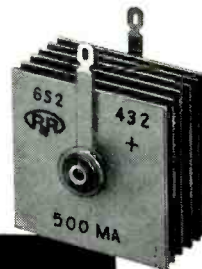

Semiconductor Division
RADIO RECEPTOR COMPANY, INC.
In Radio and Electronics Since 1922

Sales Offices: 251 West 19th Street, New York 11, N. Y., WAtkins 4-3633 • Factories in Brooklyn, N. Y.



RADIO RECEPTOR PRODUCTS FOR INDUSTRY AND GOVERNMENT: SELENIUM RECTIFIERS • GERMANIUM AND SILICON DIODES
THERMATRON DIELECTRIC HEATING GENERATORS AND PRESSES • COMMUNICATIONS, RADAR AND NAVIGATION EQUIPMENT

Farnsworth
In Defense and Industry

RESEARCH

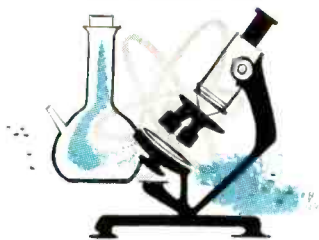

Applied Physics, Circuit Research, Solid State Physics, Low Temperature Physics.

RADAR

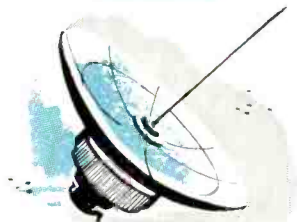

Transmitters and Receivers, Computers, Microwave Components, Pulse-Coding and Circuitry.

ELECTRON TUBES



Photomultipliers, Storage Tubes, Image Tubes, Infrared Tubes.

MISSILE



Guidance and Control System, Test Equipment.

Farnsworth **DIVISION OF IT&T**

INFRARED VIEWER
Lets you see in the dark!

Another Farnsworth Achievement!

A natural by-product of Farnsworth's outstanding work in the field of infrared. Using techniques originally developed for the military, this handy Viewer has proved equally useful in civilian life, wherever there is a need to see in the dark. Farnsworth — pioneer in television and electronics — is dedicated in this as in its other activities, to the extension of man's vision beyond the range of sight.

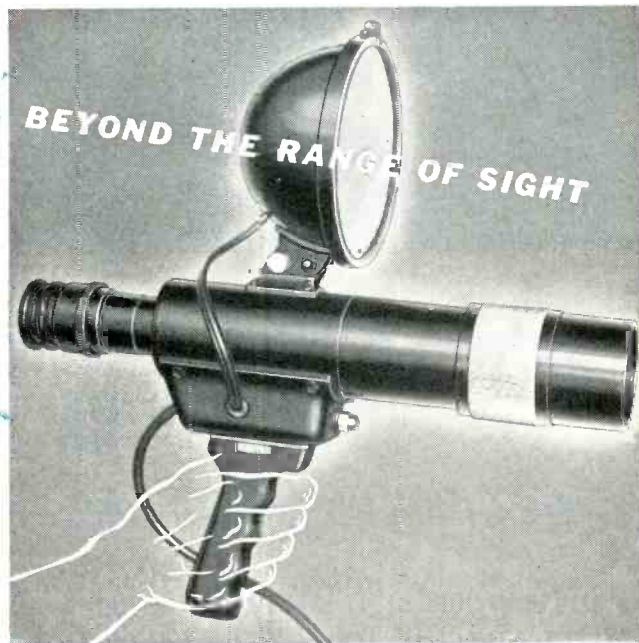

Farnsworth

The name backed by more than a quarter century of development of television and the allied electronic arts. Pioneers in the production of special purpose tubes, in the guided missile field, in infrared, and many other electronic specialties.



MOBILE PATROL SURVEILLANCE



FILM PROCESSING INSPECTION



MEDICAL BIOLOGICAL RESEARCH



MILITARY LAND-SEA-AIR APPLICATIONS

For more information on the Infrared Viewer and other outstanding Farnsworth achievements write Dept. V-105.

FARNSWORTH ELECTRONICS COMPANY • FORT WAYNE, INDIANA
a division of International Telephone and Telegraph Corporation



TRANSISTOR-RADIO! G.E.'s new All-Transistor Portable, Model 675, made possible by H.F. transistor developed by G.E.

NOW—A FULL LINE OF G-E H.F. TRANSISTORS FOR ALL RADIO APPLICATIONS

New G-E H.F. PNP Transistors, 2N135, 2N136, 2N137, Complement the G-E 2N78 NPN

THIS new line of G-E High Frequency PNP Transistors offers immediate benefits to electronics manufacturers for use in RF and IF amplifier circuits. The new High Frequency designs, now in full production, were created specifically for use in radio circuits. The line provides minimum alpha cut-offs of 3 MC, 5 MC and 7 MC—coupled with a 5 ua maximum collector cut-off current. The result: all the high-gain and high-power advantages of other General Electric transistors, *plus* operating ranges extending from 3 to 15 MC depend-

ing on the transistor selected.

NOW IN COMMERCIAL RADIO CIRCUITS
In the circuit above, the 2N136 is used as a converter—its 5 MC minimum alpha cut-off assures stable oscillator performance and high conversion gain. The 2N137—with 7 MC minimum alpha cut-off—provides 33 db gain at 455 KC. The high frequency 2N135 offers a higher collector voltage rating for the second IF where it is needed. The 2N78 NPN transistor—originally designed for computer and RF circuitry—proved ideal as a power detector and audio amplifier to drive a

2N44 power output transistor with direct coupling.

PRODUCTION QUANTITIES AVAILABLE

General Electric's new high frequency line is in mass production now. Detailed characteristics and specifications of the G-E 2N135, 2N136, and 2N137 transistors may be obtained upon request. Your G-E Semiconductor specialist and our factory application engineers have the answers to your transistor radio circuit questions. Call them in, or write: *General Electric Co., Semiconductor Products, Section X4115, Electronics Park, Syracuse, N. Y.*

Progress Is Our Most Important Product

GENERAL  ELECTRIC



MEMO

FROM: THE ENGINEERING STAFF AT NJE

TO: DESIGNERS WHO USE HIGH-CURRENT REGULATED POWER SUPPLIES

(for computers, aircraft electromechanics, mobile electronics, etc.)

SUBJECT: What is Zero-Lag?

We got tired of defining response time...so we got rid of it. Here's how:

Response time is rarely a problem if vacuum-tube "series regulator" techniques can be used. Correction for rapid load or line fluctuations is fast, and a small capacitor across the power supply output will "soak up" the small transient which occurs.

Above an ampere or two, however, the series regulator is pretty sad. Too hot. Inefficient. Expensive. Too many tubes. Too much maintenance. It is especially sad at low output voltages.

We say this without prejudice...for we build all seven types of electronic power supplies, including dozens of special series-regulator units every month.

But, when a customer comes to us for a recommendation on, say, a 10-40 volt, 20-ampere unit to actuate a high-speed jet-engine valve...or a 150 volt, 60-ampere unit for a computer plate supply...if he needs freedom from transient lags, we recommend the only system we know that will meet his requirement economically -- **NJE Zero-Lag**

Basically, our zero-lag system exhibits no lag because the voltage never leaves the regulated region. Here's the circuit:

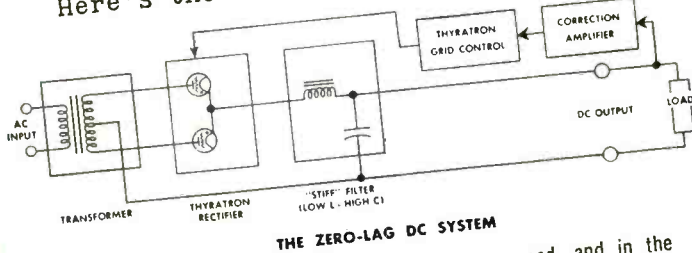

THE ZERO-LAG DC SYSTEM

The trick is in the thyatron response speed, and in the value of "C" — which is often as much as a farad. (Don't let anyone ever tell you the farad isn't a practical unit — we have over 80 farads working in the field right now.) If you have transient problems in the 0-500 volt, 0-100 ampere range—call or write us. The "lag" in our custom quotation department is about one week — but the lag in our power supplies is zero...absolutely zero.

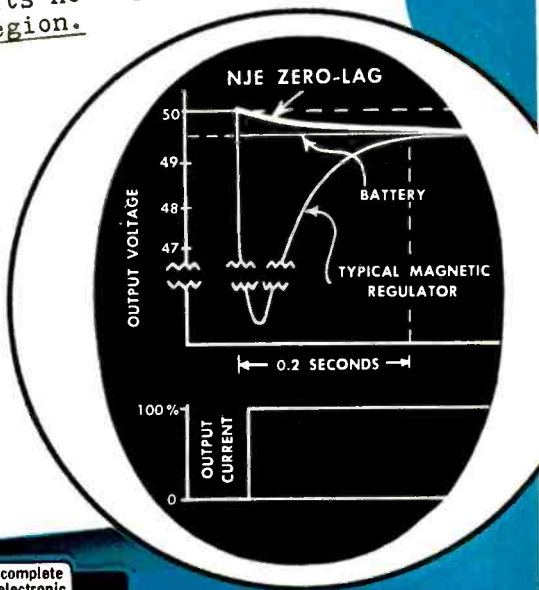

For our complete line of electronic power supplies See electronics Pg. 113-120 BUYERS' GUIDE

NJE

Write for Catalog Z-5

corporation

Electronic Development & Manufacturing

345 CARNEGIE AVENUE, KENILWORTH, NEW JERSEY

Competent Engineering Representation Everywhere

Rapid, complete, competitive custom quotes from 1000 Amperes (low voltage) to 250 KV (low current)

P O W E R S U P P L I E S U N L I M I T E D

New Phone No. Chestnut 1-1500

New Mallory Cardboard Tubular Capacitors

*... premium performance
at no increase in cost*

Never before has quality like this been built into cardboard tubular electrolytics. At no increase in price, this new series developed by Mallory offers you a combination of features unique in this type of capacitor:

Minimum size, high ripple current ratings, low RF impedance . . . obtained through use of genuine fabricated plate anodes.

Long life, high stability temperature rating up to 75°C . . . due to fabricated anode and etched cathode.

Low leakage current.

Low-resistance tab-to-lead wire connections . . . welding ends danger of intermittent or high resistance connection.

Low moisture loss . . . cartridge is foil wrapped; wax impregnated cardboard tube is sealed with wax at both ends.

High dielectric strength, exceeds U.L. requirements, due to improved low-moisture absorbent separators.

Rugged, flexible leads . . . covered with plastic insulation rated for 105° C, have U.L. approval.

The new series comes in single, dual, triple and quad sections, with leads all coming from one end or from opposite ends of the cartridge. A complete choice of voltage and capacity ratings is available.

For technical data, write or call Mallory today. A Mallory capacitor engineer will be glad to consult on your circuit requirements, to suggest possible cost-cutting simplifications based on Mallory's long experience in all types of applications for electronic components.

Parts distributors in all major cities stock
Mallory standard components for your convenience.

Serving Industry with These Products:

Electromechanical—Resistors • Switches • Television Tuners • Vibrators
Electrochemical—Capacitors • Rectifiers • Mercury Batteries
Metallurgical—Contacts • Special Metals and Ceramics • Welding Materials

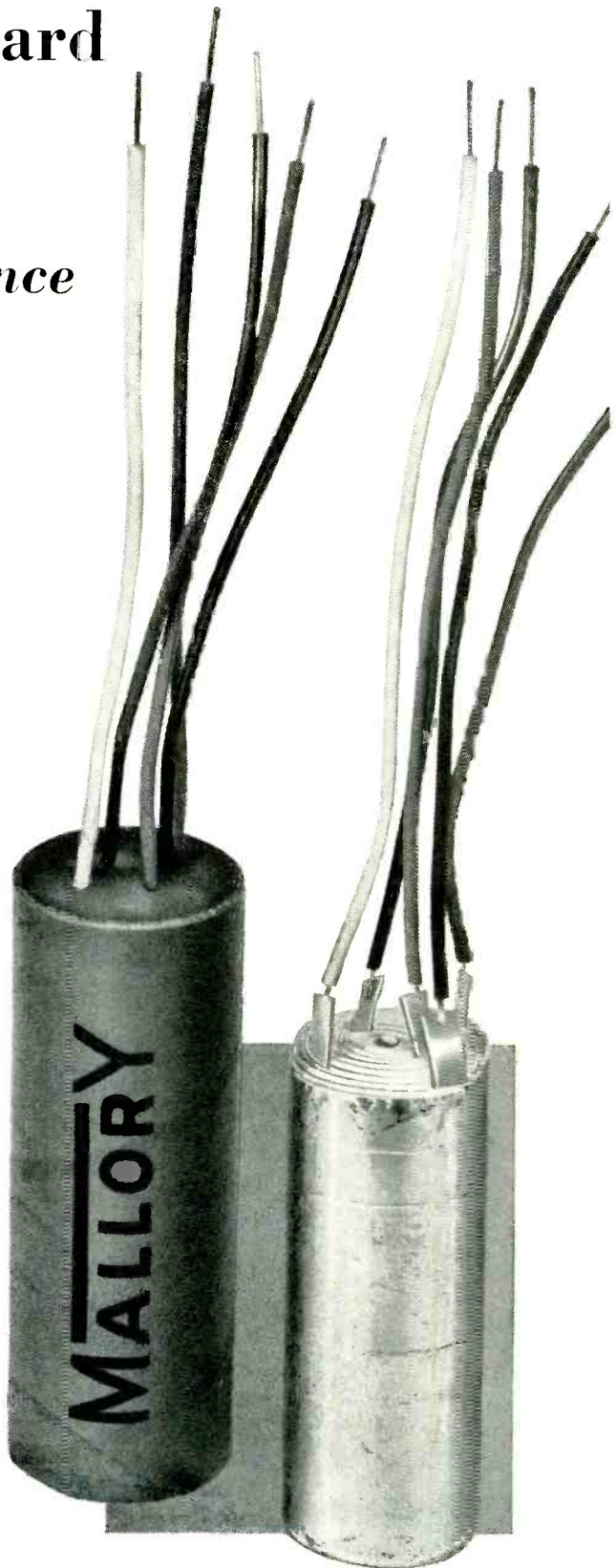

Inside of the case is this foil-wrapped cartridge. Tabs are welded to the leads, to prevent intermittent connections.





► **D.O.A.** . . . At the risk of shoveling sand against the tide, we wonder if right now would be too soon for manufacturers to pay more attention to the way their products work when they reach the ultimate consumer.

Some of the stuff reaching the home, in particular, was skimped in design, left the production line even closer to the ragged edge, and proved to be dead-on-arrival at the final doorstep. And in this day of deals and discount houses, more salesmen than servicemen, the baby more than ever before is at the tender mercy of its parents. Even if this were not so it would be difficult for middlemen to fix what wasn't there in the first place, and if they could fix it it wouldn't stay fixed long.

Now, we bought the idea of mass-production-to-reach-more-people at cribside, and still think it is the best basis for the American economy. But just how far can a good thing be carried? Certainly not to the point where merchandise fails to satisfy, even if it is cheap.

There should be more design margin . . . *and men with a conscience.* More rugged assembly . . . *and men with a conscience.* More careful adjustment . . . *and men with a conscience.* More critical

testing . . . *and men with a conscience.*

Or there will soon be more manufacturing reputations marked dead-on-arrival.

► **LOCK AND KEY** . . . If technical manpower is the key to the future, then one of the locks that will open the door is represented by guided missiles.

Important in itself, the guided missile program involves advances in just about every known application of electronics. Among these are remote control, navigation, telemetering and television. Then there are less conventional refine-

ments, already in use but currently classified. And, what is more important, an inkling of completely unconventional things to come gleaned from research in the upper atmosphere.

► **COMPUTER CAROLS** . . . With Christmas not far off, we are reminded that last year at least two labs set up their computers to play yuletide melodies at employee parties.

Don't know just how it was done because our informants want no publicity about how they set up electronic giants to do the work of a small boy.

LOOKING AHEAD . . .

Flashlight-battery-operated transistorized radios can eventually compete successfully in initial cost and operating cost with power-line-operated sets, and we don't mean just portables

Ultrasonic shaker-uppers are quietly being bought by doctors, may supersede diathermy for many therapeutic uses

Long-playing phonograph records are not necessarily forever wedded to present speeds, could someday turn slower. Also, monogroove binaural disks using a vertical cut for one channel and a horizontal for the other are a commercial possibility

The speed with which manufacturers push color-tv probably depends more than anything else upon the extent to which the public does or does not buy up monochrome stocks by Christmas

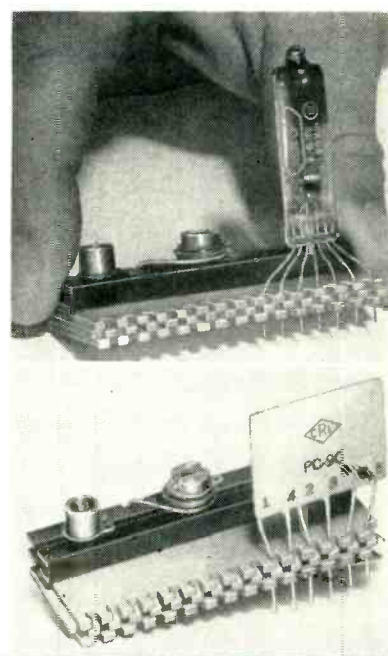
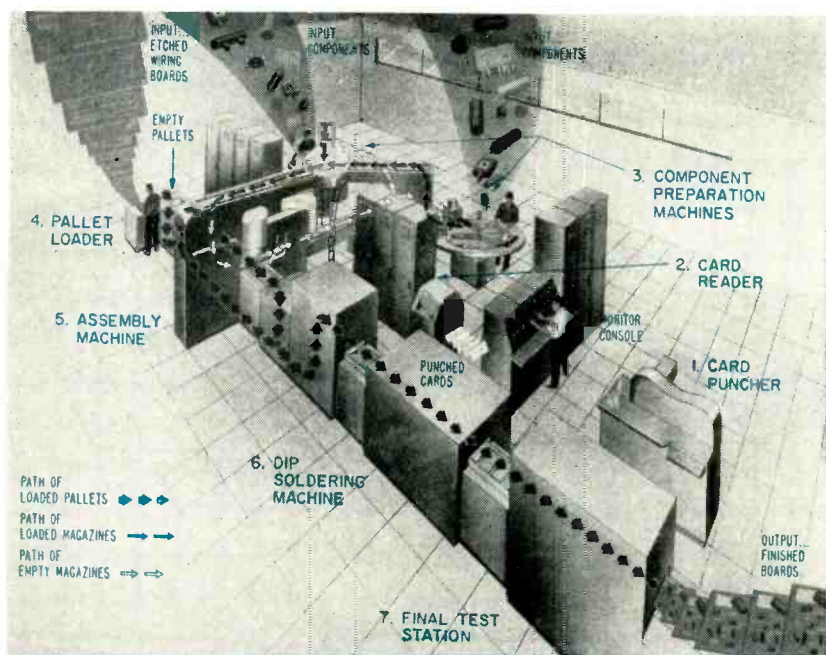

COMPLETE SYSTEM—Individual machines, now being tested, will be arranged as in this artist's sketch, requiring only 1,200 sq ft of floor space. Four operators can keep system running at full output of up to 120 boards per hour.

CARRIERS—Leads of each component are held accurately in position by three-comb spring-loaded carrier.

Punched Cards Control

SUMMARY — Programmed single-station automatic assembly machine turns out completely soldered etched-wiring boards in batches of up to 20, as required for many types of military electronic production. Components are inserted at rate of 1,600 per hour as boards on pallets recirculate under single placement head.

MANUFACTURE of electronic subassemblies in job-lot quantities of 10 to 50 is a common requirement in the production of complex military electronic systems. Use of etched wiring and dip soldering in conjunction with a memory-controlled automatic assembly system provides the flexibility and ease of changeover desirable for this type of production, along with a means for stockpiling production know-how stored in punched cards or other data storage mediums. Such data can then be used in time of emergency

to produce electronic equipment with a minimum of delay in machine setup and human operator training time.

The Signal Corps automatic component assembly system, as built by GE for job-lot electronic production, uses one operator to load etched and punched wiring boards into empty pallets at the pallet loader, two operators to feed components into the two component preparation machines and a fourth to supervise the entire operation at the monitor console. The cards required for control can be prepared

at any time beforehand by an operator familiar with a standard card puncher.

The card reader automatically supplies punched-card data for controlling the component preparation machines. These prepare components, load them into individual carriers, test the components, then load the carriers into magazines.

The assembly machine takes components from the carriers one by one and inserts them in the etched wiring boards that circulate on pallets in batches through the machine.

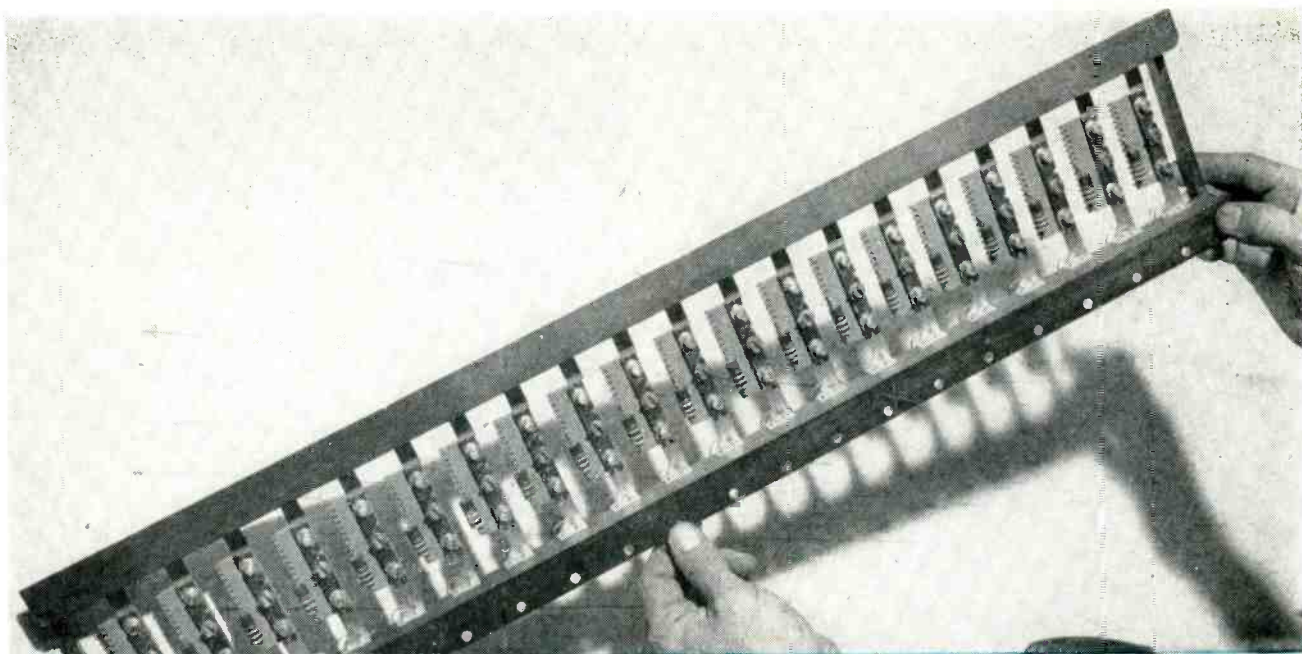

MAGAZINE—All components go through assembly machine in magazines like this, each holding 20 carriers. The one-watt resistors shown here in the carriers have leads already cut and formed, ready for insertion and clinching. Transfer head in placement machine removes a carrier for unloading, then puts empty carrier back in magazine

Job-Lot Assembly System

By **GEORGE W. GAMBLE, CHARLES J. GODWIN**

*General Electric Advanced Electronics Center
Cornell University, Ithaca, N. Y.*

and **FREDERICK S. FELDHEIM**

*Signal Corps Supply Agency
Philadelphia, Pa.*

When all components have been inserted, each assembly automatically passes through the dip soldering machine and the final test station.

All operations, from the initial preparation of the components to the final testing of the completed equipment, are automatic and are controlled by a central program set up by Remington Rand punched cards. The entire setup requires a floor area of only 30 by 40 feet. To change from one type of product to another, it is merely necessary to change the program cards and

the raw components being fed to the machines.

The component placement rate of this system is 16,600 per hour on wiring boards having a usable area of from 1 by 1 inches to 8 by 12 inches. The number of components per assembly is limited only by the usable board area. Completed assemblies are soldered at the rate of 120 boards per hour and tested at the rate of 5 tests per second.

Operation of System

Components as received from the supplier are fed into the two

component preparation machines by the operators. Here the leads are automatically straightened and formed, the components are placed in comb-like component carriers and tested and the carriers are loaded in magazines. Each magazine holds 20 like components. Prepared components are held in magazine hold areas until called for by the punched cards. A conveyor system then transports the magazines to the placement head.

The batch concept of board and component handling has been adopted in the design of this sys-

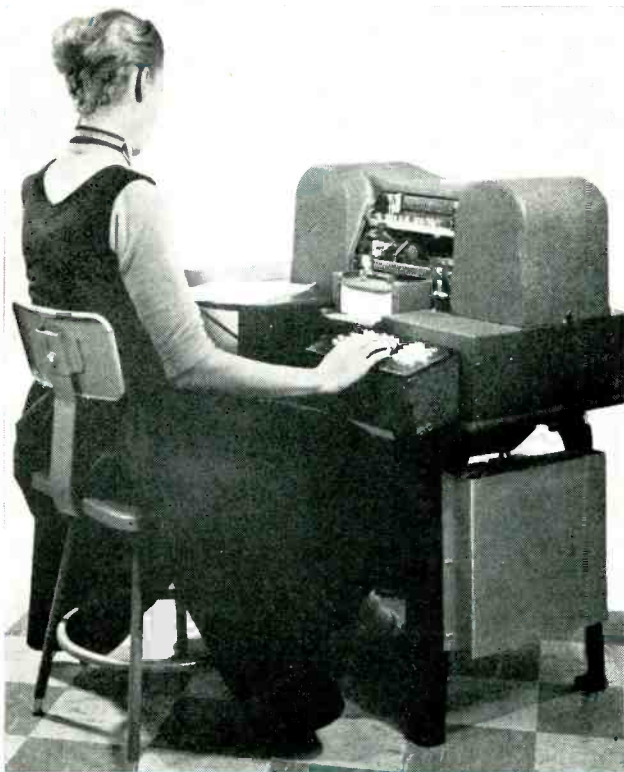

CARD PUNCHER—Keyboard of commercial model has been modified to punch binary members for programming the various machines of the Automatic Component Assembly System

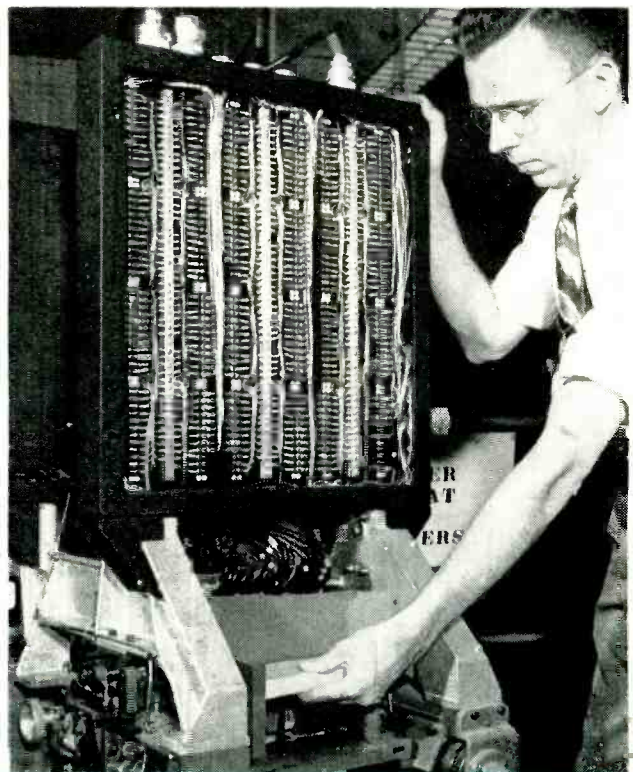

CARD READER—Minor modifications and addition of terminal boxes permitted use of standard reader, connected into control circuits of machines. Operator is loading pack of cards

tem. Up to 20 boards on pallets are fed to the placement head of the component assembly machine, along with magazines containing the required components. The board and the placement head are then servoed to their proper positions to place the first component in its position on the board and clinch its leads under the board. All boards pass under the placement head and receive this component. The exhausted magazine is then ejected from the placement head, a fresh magazine is inserted and the placement cycle repeats. The process continues until all components are placed on all boards in the batch, after which the batch is passed on to the dip soldering machine. Boards are circulated through the placement cycles by a conveyor system and two elevators.

Empty magazines are automatically returned to the component preparation machines for reuse. Empty pallets are likewise returned to the pallet loader. A wide variety of lead-mounted components can be handled, including resistors, capacitors, subminiature tubes and

resistor-capacitor couplers.

Indicator lamps on the monitor console, which give warning of system failure, are illuminated only when a fault occurs. Indicator lamps connected purely with maintenance, such as those used to assist

in locating relay failures in event of system breakdown or to check correct operation of relay trees, are located elsewhere and are switched in only when needed. Lamps at the component preparation machine are lighted to convey

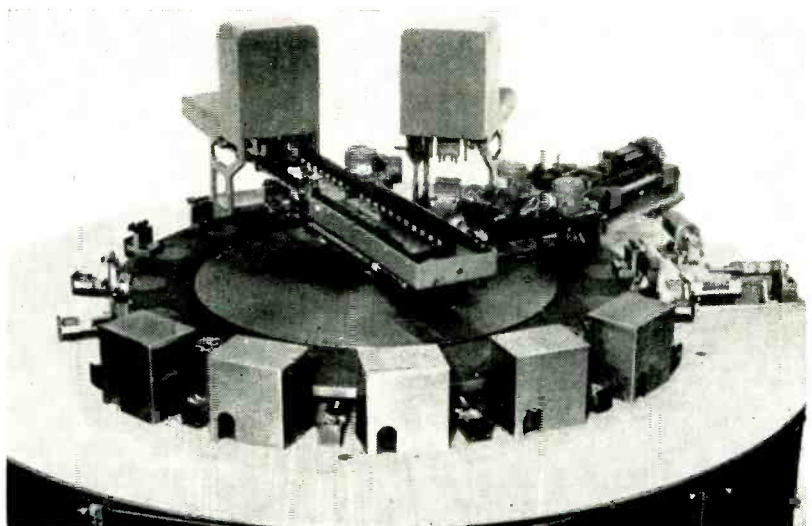

COMPONENT PREPARATION MACHINE—Components loaded manually into hoppers of this machine are automatically inserted in carriers for cutting of leads and testing, after which carriers are loaded in magazine above turntable

command, otherwise remaining unlit. Lamps on the final test machine come on only to indicate the nature of a defect in an assembled board. After test, the boards are stamped to signify acceptance or rejection, then discharged from the system at the unloading station.

Component-Handling Methods

Axial-lead components retained in corrugated cardboard strips are loaded in batches into the axial-lead component preparation machine. Here the leads are straightened and formed, then loaded into component carriers. The carriers in turn are passed through lead-trimming and test positions, then loaded into magazines.

Radial-lead and multiple-lead components are fed manually one by one through straightening dies into the carriers, then passed through lead-trimming and test positions the same as for axial-lead components.

Each component preparation machine has a 16-head indexing turntable 44 inches in diameter, having a maximum indexing speed of 1,800 indices per hour and a dwell time of 1.5 seconds.

To facilitate the entry of leads into the holes of the circuit board, all leads are trimmed after being loaded into the component carrier. This is done by a pair of rotating cutters having gear teeth to fa-

cilitate rotation from a common drive. After trimming, the cutting wheels are lowered to clear the leads so the component carrier can be indexed to the next position.

The first four index positions of the turntable are for loading and lead-trimming. The next ten are for testing the components, as follows: 5—small capacitor tests; 6—resistor, diode forward resistance and inductor continuity tests; 7,8—spares; 9,10—transistor tests (not instrumented); 11—capacitor leakage tests and diode back resistance tests; 12—large capacitor test; 13—vacuum tube shorted-element test; 14—vacuum tube gas and heater tests.

The leads of the component are contacted at the proper station by a contact assembly, the spring fingers of which have been automatically switched to the programmed test equipment under command of the punched-card reader. For resistor testing, only one station is activated, whereas for vacuum-tube testing seven stations are activated to furnish the necessary filament preheating and test voltages.

After being tested, satisfactory components in carriers are indexed to station 15 where they are loaded into transport magazines. Rejected components are not picked up, but are indexed to station 16 where they are ejected from the carrier,

and the empty carrier is indexed to the loading station for reuse.

Emptied carrier magazines go to a transfer station where the empty carriers are taken out. A pneumatic actuator pushes down spring-loaded pins that engage the bushings in the first carrier to establish alignment, then pushes open the carrier retaining springs. Other parts of the actuator then disengage the carrier from the magazine and deposit it in the nesting block on the turntable of a component preparation machine.

As the carrier-unloading assembly goes back up, an indexing mechanism is actuated to step the magazine forward to the next unloading position, for removing another carrier. When an empty carrier, already on the turret, is indexed beneath the unloading head, the unloading motion is disabled for that dwell period. When the magazine is empty, it is moved into position for receiving newly loaded carriers.

To place a loaded component carrier back in a magazine, the spring-loaded pin-and-collet assembly of the transfer head travels downward and presses the spring-loaded pins of the carrier nesting block out of the carrier bushings. The carrier is then retained on the transfer head and is loaded into the magazine on the upward stroke. Upon completion of the upward

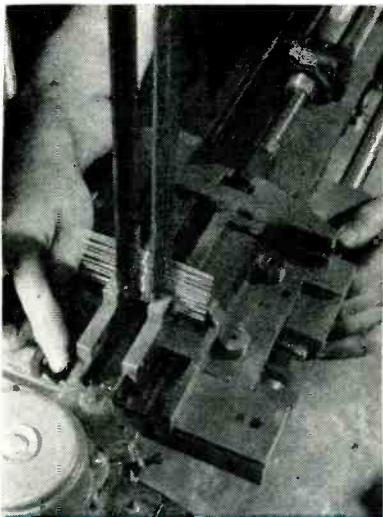

LOADER—Axial-lead components are loaded into vertical feed rack for forming and insertion in carrier

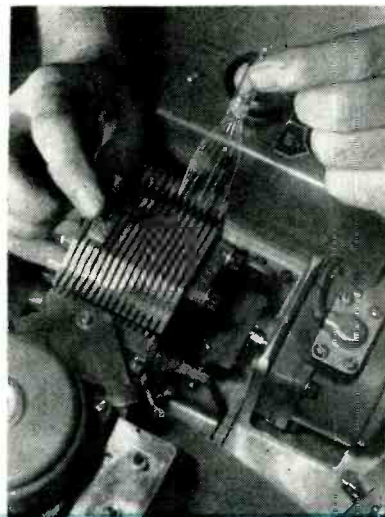

LOADER—Multiple-lead components such as subminiature tubes are manually loaded one by one

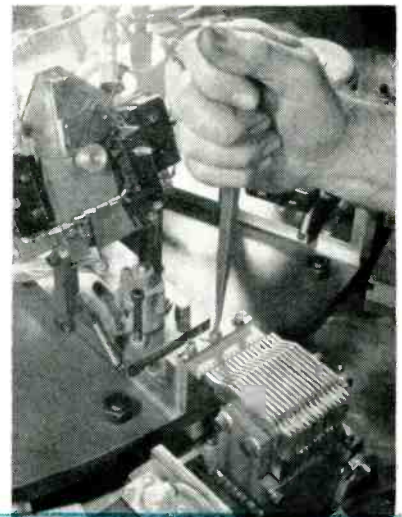

OPENING CARRIER—Screwdriver here illustrates how screw of carrier is rotated by servo to open combs

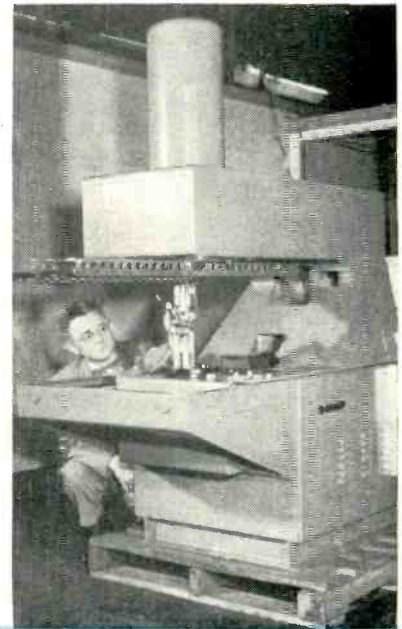
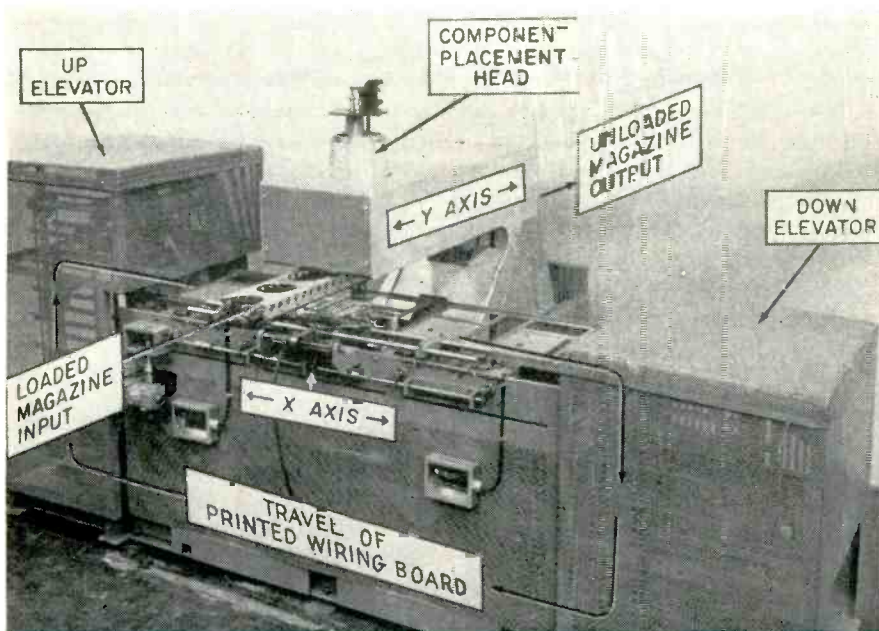

ASSEMBLY MACHINE—Servo-positioned insertion head (right) fits into center of elevator and conveyor mechanism that recycles 20 wiring boards under head until all required components have been inserted one by one. Elevators also provide required storage space at each end to accommodate adjacent machines having different operating times.

stroke the magazine is indexed one position as the turret indexes for loading the next carrier.

Upon completion of the magazine loading cycle, the magazine moves to the loaded magazine hold elevator (not yet built) to await action by the sequence control.

Magazines loaded with tested components move from either component preparation machine into magazine hold elevators. If a magazine is in the program order of placement, as remembered by the magazine sequence control from punched card data, the hold elevator elevates the magazine and moves it directly to the storage elevator at the placement head. If the magazine is out of order because of longer component preparation time required by a magazine on the other preparation machine, the loaded magazine is held in the hold elevator until the sequence control passes the other magazine to the placement head. In this way loaded magazines stored at the placement head are always in the program order of placement.

The order of flow of magazines from which components have been removed by the placement head has no significance. The order of flow becomes important after a magazine is loaded and enters the hold

elevators of the placement head.

The component placement head is positioned over the 12-inch dimension of the printed wiring board on what is termed the Y axis and may also be rotated through a maximum of 157.5 degrees.

Loaded magazines are inserted in the placement head at the $Y=0$ position upon demand of the head

control circuits. The board-holding pallet is programmed in the 8-inch dimension of the board, called the X axis. The head and board are positioned at the beginning of the placement cycle for each batch of components.

Component placement is achieved by stripping a loaded carrier from its magazine and bringing the car-

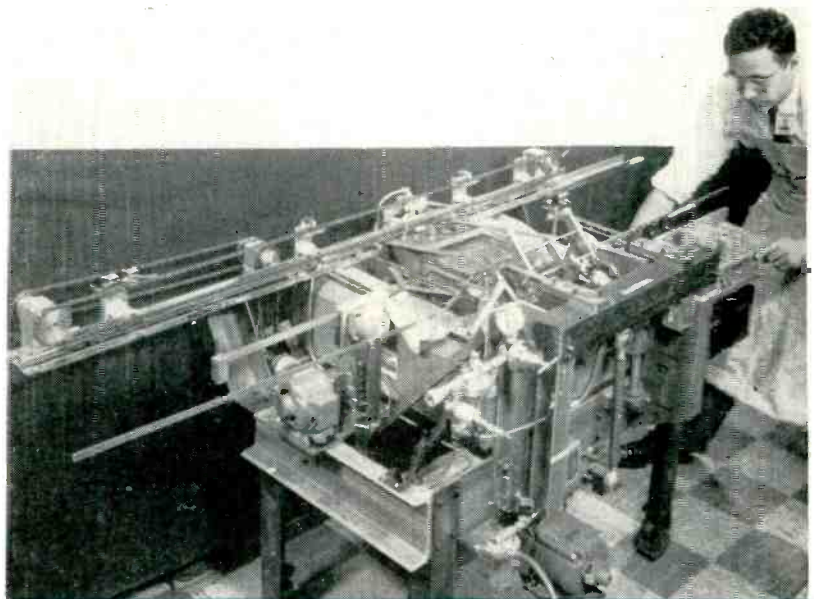

DIP SOLDERER—Head is removed to show mechanism that receives board-carrying steel pellets at right end, moves them over spray fluxing station first, then brings them over solder pot and slowly moves solder ladle up to bottom of board.

rier down to the board. The component leads are pushed through the board and grasped by a lead-anchoring mechanism while the carrier is moved away from the component and returned to the magazine. The gripping jaws then draw the component leads down through the board and cut and bend the leads to secure the component mechanically. The magazine is then indexed one carrier position, the next board is brought up and the cycle repeated.

Components can be placed within 0.090 inch of each other if their size permits. However, mounting holes must be staggered for such close placement. The maximum component size which can be handled is 2.35 inches long, 2 inches high and 0.75 inch wide. The system will handle components having up to eight leads. All leads are placed in line. Components can be placed in angular positions of up to 157.5 degrees in 22.5-degree steps.

When all components in the batch have been placed, the unloaded magazine is ejected through the back of the head frame and conveyed to the unloaded magazine storage elevator.

Pallet-Circulating Conveyor

Input information consisting of the number of component boards, the number of components per board and the X-axis servo information is supplied by the punched-card reader at the beginning of a new batch. The board pallets are then automatically loaded into the bottom of the up elevator of the pallet-circulating conveyor. The control indexes the up elevator a step at a time, filling all slides in the elevator. The pusher at the top of the elevator ejects the pallet onto the upper pallet drive and index mechanism.

When the first pallet reaches the active work station, it is slowed and stopped, taper pins are pushed into the holes in the pallet, and an interlock is closed to the head circuit which allows the head to place a component. When the head has placed a component and is sufficiently clear of the board to allow pallet motion, a signal is given to the controller which retracts the taper pins and allows the board

to be driven away, and the next pallet is indexed into position. The pallet being driven away will be placed in the top of the down elevator and the elevator will index one step down and wait for the next pallet. As the pallet reaches the bottom on the down elevator it is ejected into the lower pallet drive, as are all subsequent pallets.

When the desired number of pallets have entered the circulating system, the control transfers from load to cycle and pallets enter the up elevator from the lower pallet drive unit, operating on a demand signal from the head. The same is true for the down elevator.

At the dip soldering machine the boards are first passed over a fluxing spray of rosin and alcohol, then positioned over the solder pot. The solder ladle, immersed in the solder pot, is brought up to the board as the board is rotated into its solder surface. The board is vibrated while it is in the solder bath to clean it and bring solder into intimate contact with the joints. A time-delay relay controls immersion time. The board is then rotated away from the solder bath and again vibrated to remove excess solder while the solder is still molten. A short dwell period then permits the solder to solidify before the board is trans-



SOLDERING—Assembled wiring board and pallet rest on solder ladle, which comes up out of solder pot here

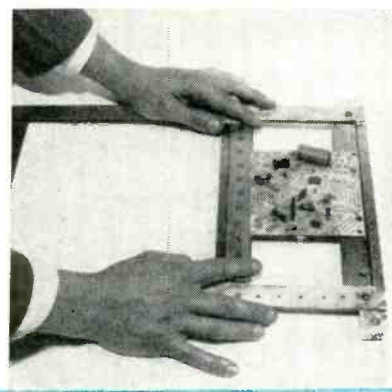

PALLET—Universal design can be easily set to take boards up to 12 inches long and 8 inches wide

When the last pallet of any batch is ejected from under the head, the programming control stops the pallet circulation until the X-axis positioner has been reset for the next component. The system circulates pallets in this manner until the first pallet has had all the components placed and has appeared at the bottom of the down elevator. The control will then actuate the pusher on the bottom of this elevator to eject the pallets from the loop. When all the pallets in the batch have been ejected from the loop the control automatically requests new data for the next cycle.

The loaded pallets are ejected from the pallet circulating conveyor into the presolder storage elevator, from which they are drawn on demand of the dip soldering machine.

ferred to the storage elevator for the final test station.

Final Testing

Since all components are tested before assembly and the component transport system is interlocked to prevent misalignment of components during their placement cycle, there are only three conditions which could cause failure of the printed circuit assembly: (1) component leads not going into their holes; (2) component leads not soldered; (3) solder shorting out etched wires on the board.

Two types of tests are used to determine acceptability of a finished circuit board: the shorts test, which measures an extremely low impedance between any one etched wire and the others; and the continuity test, which measures a low impedance between one lead

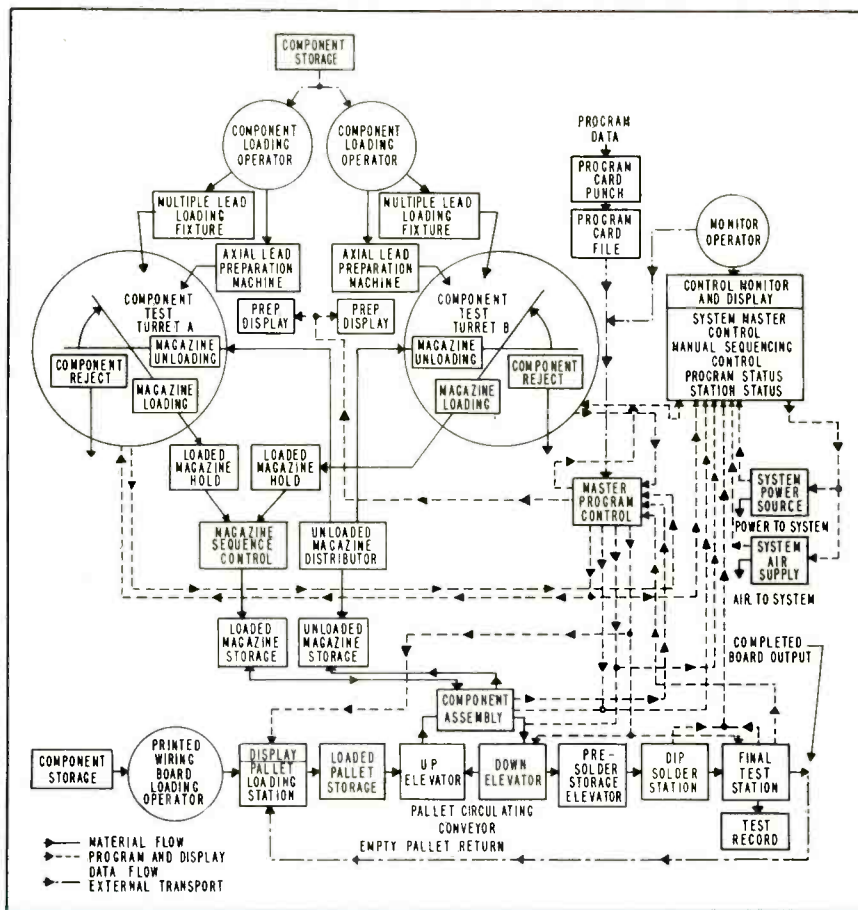

FLOW DIAGRAM—Dashed lines show how punched cards in master program control serve to actuate and monitor all machines, thus assuring proper assembly sequence. Paths of wiring boards are represented by solid arrow lines between boxes



FINAL TEST—Pallets with boards will enter at top right on conveyor now under construction



MONITOR CONSOLE—Main lamps come on only to indicate malfunctions. Emergency button stops all machines

of a component through a solder joint, along the etched wire, and through the lead of another component soldered to the same etched wire. Thus, the first test detects shorted conductors. The second detects whether or not a lead has gone into a hole and if it has been soldered, but not the quality of the solder bond. A paper tape printer automatically records the number and type of failure on each board as the test is made.

Punched-Card Equipment

The function of the card punching machine is the transformation of all necessary system control data into punched-card coded form. The data consists primarily of five types: (1) complete specifications of the components to be prepared and assembled, including data on the various preassembly tests to be performed; (2) data to control the order of preparation and as-

sembly of each circuit element; (3) data specifying the number of printed circuit boards to be assembled in the particular batch; (4) data specifying the accurate location of each circuit element on the printed circuit board; (5) data specifying the tests to be performed on the completed circuit board assemblies.

The card reader senses the recorded data and transmits it in appropriate form to the various machines.

A single stack of punched cards is made up for each board design. Each card contains program data for one or more of the individual stations within the system.

The automatic component assembly system program has been carried out under Signal Corps Contract DA-36-039-sc-30250 as an industrial preparedness measure. The contract is between the Signal Corps Supply Agency, Philadelphia,

Pa. and the General Electric Light Military Electronic Equipment Department, Utica, N. Y. The work has been carried out by the GE Advanced Electronics Center, Cornell University, Ithaca, N. Y., with some work being subcontracted to the GE Equipment Development Plant and the GE General Engineering Laboratory at Schenectady. The project is being monitored for the Signal Corps by the Supply Agency at Philadelphia and by the Signal Corps Engineering Laboratories at Ft Monmouth, N. J.

BIBLIOGRAPHY

- S. F. Danko and S. J. Lanzalotti, *Auto-Assembly of Miniature Military Equipment*, *ELECTRONICS*, p 94, July 1951.
- Walter Hausz, *The Development of an Automatic Component Assembly System*, 1954 *Electronic Components Symposium*, Washington, D. C.
- Ben Warriner and George W. Gamble, *A Flexible Automatic Component Assembly System*, IRE National Convention, New York City, March 23, 1955.
- Philip J. Klass, *Punch Card Control Gives Auto-Assembler Flexibility*, *Aviation Week*, May 2, 1955.
- John Markus, *Mechanized Production of Electronic Equipment*, *ELECTRONICS*, p 137, Sept. 1955.

Temperature Indicator for Aircraft Engines

SUMMARY — Precision potentiometer type device in which the thermocouple output is compared with a reference voltage gives precise temperature indication in aircraft jet engines. System accuracy is better than ± 5 C

By **HAROLD KOLETSKY** *Project Engineer
Avien, Inc.
Woodside, N. Y.*

JET ENGINE use in military aircraft has brought with it severe requirements in engine temperature instrumentation.

To obtain maximum thrust from these engines and yet avoid damage to turbine buckets through overheating, requires precise indication of operating temperatures under all extremes of flight and environmental conditions.

The temperature-indication system to be described was developed for the U. S. Air Force. It replaces the galvanometer type of instrument for the measurement of exhaust-gas and turbine-inlet temperatures over the range of 200 C to 1,200 C.

The basic system is shown in Fig. 1. The principle used is similar to that of the laboratory type potentiometer commonly employed for high-precision temperature measurements, in which the output of a thermocouple is measured against an accurate reference voltage. A servo-driven self-balancing bridge is utilized to provide automatic, continuous comparison of these voltages and their translation into corresponding temperature indications.

In applying this principle to aircraft use, there are four major design problems. Foremost is the requirement for a precise d-c reference voltage. A nonlinear potentiometer is required to produce linear rotation versus temperature,



Temperature indication system is used in Lockheed's C-130-A Hercules. Gages measure turbine-inlet temperature of the plane's four turbo-prop engines

compensating for the nonlinear characteristics of the standard aircraft thermocouple. A null modulator capable of detecting d-c error signals as low as 40 microvolts, corresponding to a temperature change of 1 C, and a cold-junction compensator are also needed.

The problem of the thermocouple probe was not considered, since a requirement of the system is that it be designed for use with the standard aircraft thermocouple.

D-C Reference Voltage

To obtain an accurate d-c reference voltage, the K-Volt Standard was developed. This unit, which plugs into a standard noval tube socket on the amplifier chassis, employs three double-anode silicon

diodes which have been selected for their stability of characteristics with time and with variations of ambient temperature.

These diodes are connected as shown in Fig. 2.

Operation of the circuit can be understood by considering the dynamic diode characteristics shown in Fig. 3. For any double-anode diode, once the breakdown voltage has been achieved, the dynamic resistance is of the order of 10 ohms. The device behaves like a voltage regulator. Regulators are cascaded to provide a voltage output that is constant within ± 0.05 percent, for a 10-percent line-voltage variation.

The silicon junction diodes used in this application are of the low

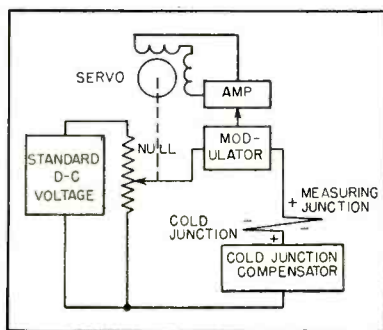

FIG. 1—Basic temperature-indication system for jet-engine use

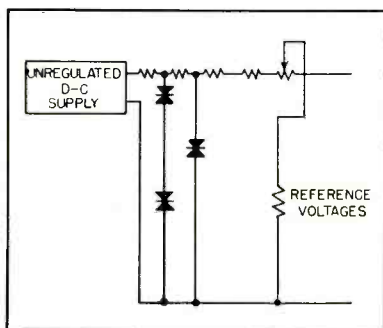

FIG. 2—Double-anode diode voltage-regulating circuit

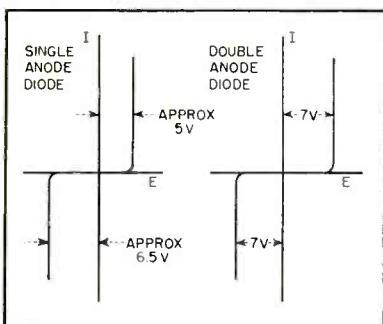

FIG. 3—Dynamic characteristics of reference diodes

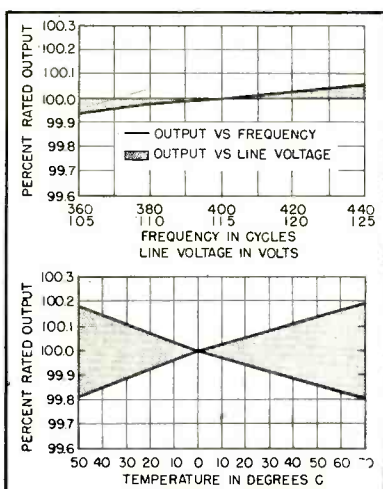

FIG. 4—Curves show output of voltage standard with variation of temperature, line voltage and frequency

Zener voltage type. The most interesting property of these diodes is their behavior over wide ranges of ambient temperature (-65°C to $+100^{\circ}\text{C}$). Temperature induced changes of their forward-conduction characteristics are almost exactly equal and opposite to the changes of their reverse-conduction characteristics. By combining two diodes into a double-anode diode, a reference-voltage device virtually independent of temperature is achieved.

Theoretical life of these units is in excess of 10,000 hours of operation. Laboratory tests, including temperature cycling, for more than 1,000 hours show stability of better than 0.1 percent.

Stability of the voltage standard over the entire range of line voltage, frequency and temperature variations encountered in aircraft service are shown in the curves of Fig. 4.

For line-voltage variations from 105 volts to 125 volts and temperature variations from -55°C to $+70^{\circ}\text{C}$, the reference voltage is maintained within 0.25 percent of rated output. However, this figure represents the worst conditions that might arise from these variations. As seen from curves, voltage and temperature effects are random within the envelopes plotted. Under actual service conditions stability may be better than specified.

A nonlinear potentiometer produces linear shaft rotation by locating taps on a linear potentiometer and loading it to produce the desired function. This technique brings with it the added feature of making each loaded potentiometer equal in resistance within ± 0.05 percent. This provides for complete interchangeability of indicators.

Temperature

Temperature compensation of the thermocouple cold junction is accomplished by using a pair of resistors, one sensitive, the other stable to temperature change. The stable element provides an essentially constant current to the other resistor. Thus the voltage across the temperature-sensitive resistor is determined by its temperature coefficient of resistance which has

been selected for close similarity to the output-versus-temperature curve of the thermocouple.

In this case an iron-nickel alloy was chosen for the temperature-sensitive resistor and a nickel-chromium alloy for the temperature-stable resistor. Both compensating resistors are wound on the same bobbin, with the cold-junction thermocouple embedded under the wire that is compensating it.

Throughout the system precautions are taken to insure against the presence of secondary thermojunctions. At the amplifier input, thermocouple leads are brought to terminal studs made of the respective thermocouple materials. Within the amplifier the compensating resistors, along with all thermocouple junctions and the voltage standard, are housed in a hermetically sealed, silicon-oil thermal sink, which maintains all components at the same temperature.

Complete System

The schematic of the complete system is shown in Fig. 5. Note that the potentials of the thermocouple measuring circuit, the cold junction and the cold-junction compensator are in series with the voltages developed across the zero-adjustment potentiometer and the rebalance potentiometer.

In calibrating the system, the resultant of cold junction and cold-junction compensator voltages is cancelled out by the zero adjustment. Accordingly, balance is achieved when the voltage across the rebalance potentiometer equals that of the thermocouple measuring junction.

Any change in the temperature of the measurement junction will unbalance the system, producing a corresponding d-c error signal. This error signal is applied to the input of the signal modulator and is converted into a 400-cycle a-c signal which is amplified to actuate the servo-motor. The rebalance potentiometer is then driven to a new balance position corresponding to the new temperature of the thermocouple measurement junction.

The input to the amplifier is through a transformer. This is necessitated by the requirement

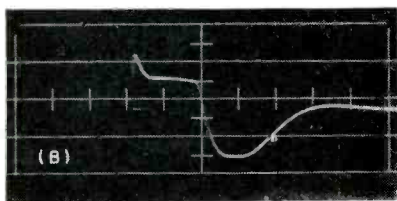
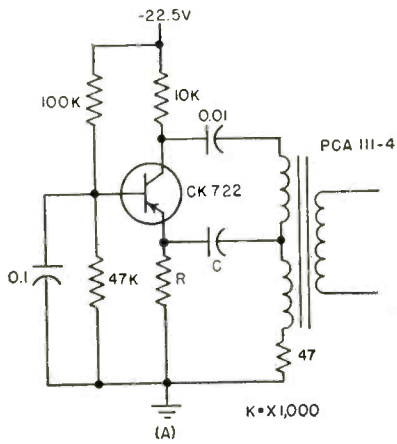

FIG. 1—Grounded-base blocking oscillator (A) provides output pulse (B) of 3.5 μ sec duration

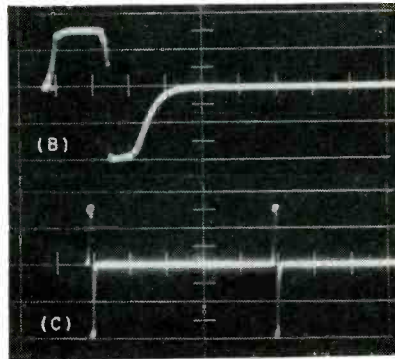
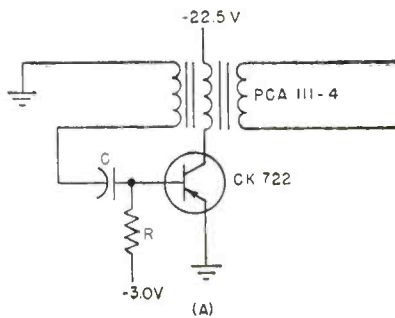

FIG. 2—Grounded-emitter oscillator (A) output pulse width (B and C) can be varied by changing value of C and R

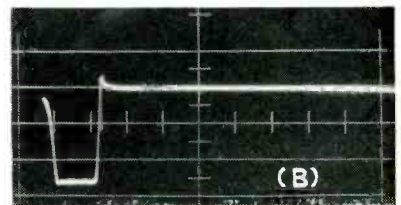
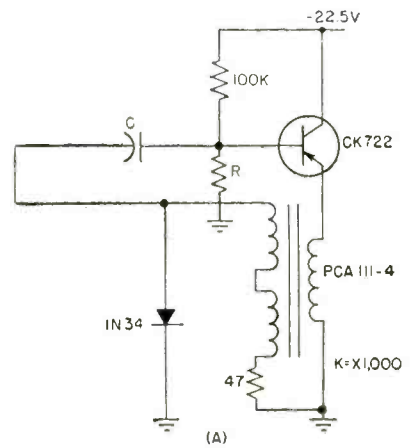

FIG. 3—Blocking oscillator (A) using grounded-collector arrangement produces flat-topped pulse (B)

Transistor Pulse Generators

SUMMARY — Five pulse-forming circuits using germanium and silicon transistors have pulse rise times as fast as 0.1 microsecond at repetition frequencies to 50,000 pps. Pulse widths are variable 0.4 to 9 microseconds

MISSILE telemetering and supersonic aircraft require rugged compact components. The five transistor circuits described here meet these requirements and provide a wide choice of pulse characteristics.

The grounded-base blocking-oscillator circuit is given in Figure 1A. Feedback has been added from collector to emitter. This circuit employs a CK 722 junction transistor and a PCA 111-4 pulse transformer. For oscillation to occur, the voltage at the collector must be stepped down to drive the lower impedance emitter. The pulse duration using this transformer should be 4 μ sec.

The pulse-repetition frequency

may be varied from 60 to 50,000 cps by varying R and C. At frequencies above 50,000 cps there is considerable jitter in the output. By letting C = 0.01 μ f and R = 10,000 ohms the prf is approximately 12,500 cps.

The rise time of the voltage pulse measured at the collector is approximately 0.5 μ sec and the pulse duration is 3.5 μ sec. By using different values of C the pulse width may be varied slightly. The amplitude of the collector pulse is +17 volts. The waveform of the collector pulse is shown in Fig. 1B.

A 47-ohm resistor was placed in series with the transformer winding to give an indication of the

peak current drawn during the conduction period. The amplitude of the peak current is approximately 50 ma. This circuit has been operated continuously in excess of 1,000 hours without any degradation in performance.

Another blocking-oscillator circuit tested is shown in Figure 2A. This circuit is a grounded-emitter configuration with the feedback from the collector to base.

The prf may be varied by changing C, R or the bias-supply voltage to the base. With C = 0.01 μ f and R = 10,000 ohms the prf is 2,000 cps. The collector pulse is given in Fig. 2B and Fig. 2C. Care should be taken in the selection of C since

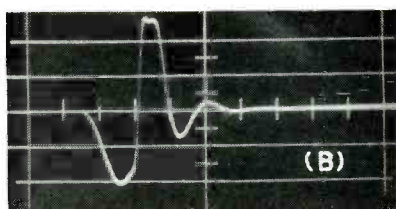
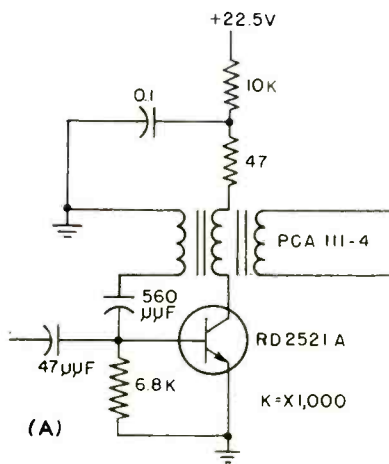

FIG. 4—Oscillator circuit (A) triggered by 2.0 volt pulse provides a 0.5 μ sec output (B)

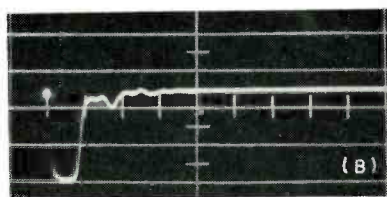
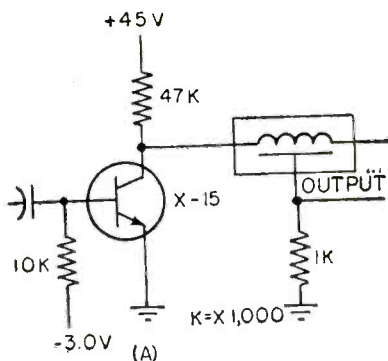

FIG. 5—Pulse-forming network (A) gives an output pulse (B) of 0.55 μ sec with a rise time of 0.1 μ sec

By WILLIAM S. ECKESS, JOE E. DEAVENPORT and KENNETH I. SHERMAN

Emerson Electric Mfg. Co.
St. Louis, Missouri

it has a considerable effect on the pulse width.

With $C = 0.01 \mu\text{f}$ the pulse width was 9.0 μsec . When the value of C was decreased to 0.001 μf , the pulse width was decreased to 5.0 μsec . The wide variation in pulse width is due to the low base-to-emitter resistance. The rise time measured at the collector was about 0.8 μsec for both pulse widths. The amplitude of the collector voltage pulse was 20 volts.

The grounded-collector blocking oscillator in Fig. 3A uses the emitter-to-base circuit for the required feedback. For this circuit to oscillate, the voltage fed back to the base must be larger than the emitter voltage. The polarity of the transformer is such that the base is driven negative as the emitter potential decreases. The diode is used to clip the overshoot.

The rise time of the emitter pulse, shown in Fig. 3B, was approxi-

mately 0.5 μsec and the pulse width was 7.5 μsec for C equal to 0.005 μf and R equal to 50,000 ohms. Pulse width is again a function of capacitance. An extremely flat-topped pulse is obtained from the emitter of this circuit. Pulse amplitude is equal to supply voltage. For the values of R and C given, prf is 3,600 cps.

The circuit shown in Fig. 4A uses an RD2521A, npn junction transistor and a PCA 111-4 pulse transformer in a triggered blocking-oscillator circuit. This transistor has a rated f_{co} of 2.5 mc compared to the rated f_{co} of 0.8 mc for the CK722. The f_{co} is the frequency at which the α of the transistor is 3-db lower than the low-frequency α . Pulse width should be in the neighborhood of 0.4 μsec .

Since no bias has been supplied to the emitter-to-base diode this circuit cannot run free. When a positive pulse is applied to the base,

the diode is biased properly for transistor action to occur. The positive trigger voltage required to start blocking action is approximately 2.0 volts.

Figure 4B gives the waveforms measured at the collector of this circuit. Pulse width of the collector pulse was measured to be 0.5 μsec with a rise time of 0.2 μsec . The amplitude of the collector pulse is 17 volts. Current pulse measured at point A is about 2.5 volts in amplitude which indicates that a peak current of 50 ma flows through the circuit during conduction.

Pulse-Forming Circuit

The pulse-forming circuit, shown in Fig. 5A, employs an X-15 medium-power silicon transistor and a Technitrol Eng. Corp. Type D delay line.

Initially, the pulse-forming network is charged to a positive voltage by the supply voltage. When the transistor conducts, the line is discharged through the output resistor generating a negative pulse having a duration of twice the delay time of the delay line. The amplitude of the pulse is one-half the supply voltage if the line is terminated in the characteristic impedance of the pulse-forming network.

An X-15 transistor has been used because it has a higher collector voltage rating than most transistors. Other types of transistors have been tested in this circuit with good results. The delay line used has a delay of 0.3 μsec and a characteristic impedance of 1,000 ohms. The response of this line is about 2.2 mc for 3-db attenuation.

The input pulse applied to the base of the transistor was generated by the grounded-base blocking oscillator discussed earlier. The input trigger has a prf of 2,000 cps, an amplitude of +8 volts, rise time of 0.5 μsec with a pulse duration of 3.5 μsec .

Figure 5B is a reproduction of the output pulse generated by this circuit. This pulse has a rise time of 0.1 μsec and a width of 0.55 μsec with an amplitude of approximately 22 volts. Rise time is determined by the speed at which the transistor starts to conduct and the characteristics of the delay line.

Helicopter Measures

By **HELMUT BRUECKMANN**

*Signal Corps Engineering Laboratories
Fort Monmouth, New Jersey*

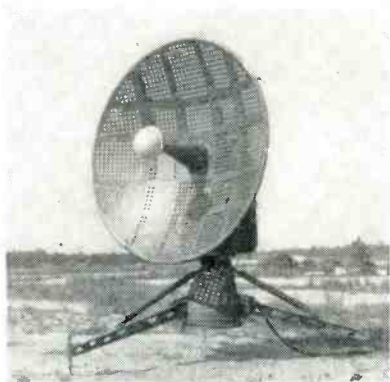

Tracking device of Rawin set used in radiation pattern measurements

THE SPACE radiation pattern of a large antenna is usually measured by constructing a scale model of small enough size and testing this model on an antenna pattern range.

The better solution is to measure the space pattern directly by means of an aircraft. Aircraft pattern measurements have seldom been made in the past. They have a reputation of being costly, unreliable or inaccurate.

Delicate measuring equipment was operated under cramped space conditions in a strongly vibrating aircraft. The limitations of the aircraft and of the pilot in maneuvering it were not properly taken into account. The method for positioning of the aircraft was slow and necessitated a long flying time. Finally, the problem of the reference or illuminating antenna was not always solved satisfactorily.

Recent tests resulting in successful pattern measurements of a large antenna have shown that accuracy can be improved and cost reduced.

Improved Method

The instrumentation used is shown in Fig. 1. Both horizontal and vertical polarization patterns can be measured. A small, self-contained signal-source is located in the center of a dipole antenna suspended from an aircraft by means of a nylon string. A c-w signal of constant intensity is transmitted, at the test frequency.

Depending upon the kind of polarization desired, the dipole is

arranged either in a horizontal position, as shown in Fig. 1, or in a vertical position. For vertical polarization, the wind sock is replaced by a weight of small wind drag. This permits large separation between the signal source and aircraft.

Orientation of the dipole axis, which is the direction of minimum radiation, is in the direction of the aircraft. Therefore, the effect of the body of the aircraft on the pattern of the dipole is negligible.

A slow-flying light aircraft with a ceiling altitude of about 10,000 feet is required. The aircraft actually used was the Army type H19 helicopter. It is assigned to fly in circles of prescribed radii about the antenna at set altitudes, as illustrated in Fig. 2. The altitude is held constant for the duration of each circle. The radius of each circle is also held constant. For this purpose ground markers are laid out on the circle. The pilot is also aided by information given to him through voice communication equipment from the ground. Any deviation from the prescribed radius is determined and accounted for in the evaluation so that it does not affect the accuracy of the pattern.

The signal transmitted from the aircraft is received on the ground by means of the antenna under test, and a highly stable and selective receiver. Its strength is recorded continuously versus elapsed time with a fast moving recorder. The

time scale is linear and the signal strength scale is logarithmic extending over a range of about 40 db.

The reference level is calibrated in terms of receiver input voltage every time the gain is changed by means of a signal generator. The signal recorder is equipped with an events marker.

Tracking

Special tracking equipment is positioned on the ground close to the antenna under test. It automatically records the azimuth and elevation angle of the aircraft by means of a position recorder. This tracking equipment prints the angles as numbers every 6 seconds on tape. The angles are accurate to 0.01 deg. Each time the position recorder prints, it closes a circuit which operates the events marker attached to the signal recorder. This permits exact coordination between signal and position recording.

The increase in range with altitude resulting from the prescribed flying path and the variations in range due to deviations of the aircraft from the prescribed flying path are taken into account. Signal strength is corrected prior to transferring it onto the pattern plot or onto a contour map. These corrections, however, are usually small enough to be neglected. If the actual range deviates as much as 20 percent from the assumed range, for example, this deviation amounts to an error in signal strength of only 1.6 db. The actual range R is computed from the measured alti-

Antenna Patterns

SUMMARY — Space radiation patterns of large and complex antennas are measured by using a helicopter towing a small self-contained signal source and dipole antenna attached to a windsock. Pattern plotted in less than 3 hours flying time is accurate within 20 percent

tude H above ground level and elevation angle ψ by means of

$$R = \frac{H}{\sin \psi} \quad (1)$$

In measurements of horizontal polarization the dipole is always essentially at a right angle to the radius of the antenna and therefore no corrections accounting for the dipole pattern are necessary. In measurements of vertical polarization, however, corrections accounting for the difference of the dipole pattern (which is a $\sin \theta$ function) and the pattern of an isotropic radiator have to be made.

These dipole correction patterns can usually be neglected if elevation angles below 33 degrees only, corresponding to an error smaller than 20 percent, are considered. If higher angles are considered, these corrections can be determined easily since the angle θ between the dipole axis and the direction to the antenna under test equals $(90 - \psi)$ deg and the elevation angle ψ is known.

For measuring the radiation at high elevation angles, above 45 deg, a somewhat different flight path is indicated. It is usually sufficient to measure the radiation at these high elevation angles in the principal plane only. The procedure outlined in Fig. 3 then applies, in the case of horizontal polarization. The corresponding flight path for vertical polarization would be a horizontal line in the principal plane.

The airborne signal source consists of a battery-operated crystal-

watt output power. Its circuit diagram is shown in Fig. 4. It is encased in an aluminum shell.

The shell consists of two halves insulated from each other by a teflon ring and connected to opposite ends of the amplifier tank coil as shown in the photograph. All components are designed to withstand shocks of 30 g .

A 5-foot length of wire is con-

nected to each of the halves of the shell, thus providing for an antenna of 10 feet fed in the center. A metal ball or double-cone is attached to each end of the wire.

For measuring vertical polarization, the antenna is suspended at the end of 150 feet of nonconducting line, preferably nylon string. The lower end of the dipole is attached to an 18-lb metal ball, the

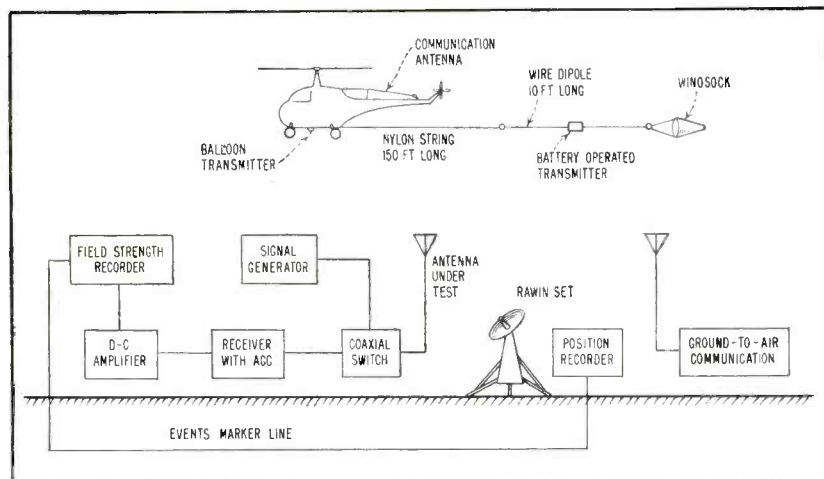

FIG. 1—Instrumentation for antenna radiation-pattern measurements

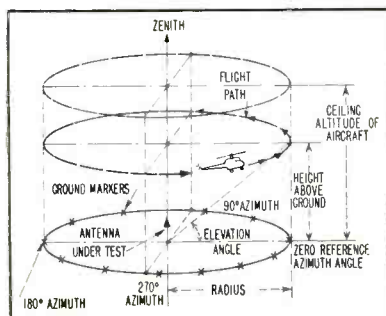

FIG. 2—Flight path of aircraft for radiation-pattern measurement at elevation angles below about 45 degrees

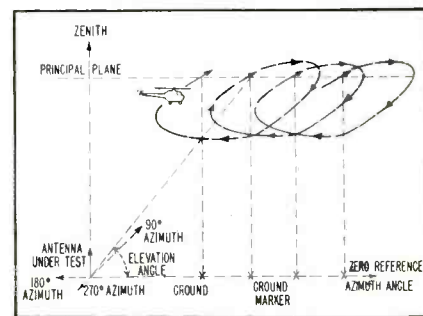
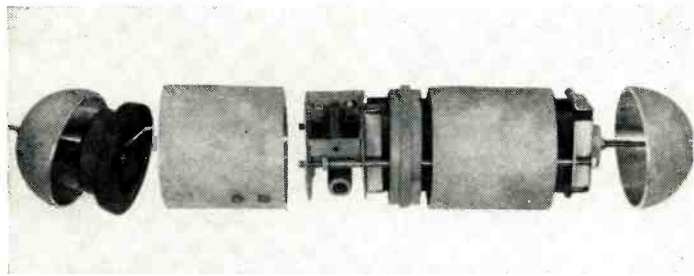

FIG. 3—Aircraft flight path for radiation pattern measurement at elevation angles above about 45 degrees



Exploded view of airborne signal source used for radiation pattern measurements of both vertical and horizontal polarization

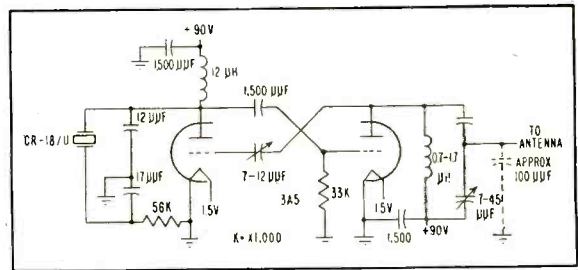

FIG. 4—Battery-operated crystal-controlled transmitter is used as airborne signal source

upper end to a light-weight metal ball. The metal ball at the lower end keeps the dipole as nearly vertical as possible and increases the effective height of the dipole. The metal ball at the other end is added to balance the antenna electrically to provide for a well-defined reference.

For measuring horizontal polarization the weight is replaced by a light-weight ball and a wind sock. The wind sock is of conical shape made of nylon cloth and is similar to the ones commonly used for indicating wind direction at airfields.

The wind sock is 27 inches in diameter at the inlet, 6-feet long and tapered down toward the end to a diameter of 6 inches. Its precise diameter and length were determined from the requirement that it exert a wind drag of 40 lb at an air velocity of 70 miles per hour.

The metal balls in the case of horizontal polarization are utilized mainly to make retuning of the transmitter unnecessary when switching polarization.

The tracking equipment consists of Rawin set AN/GMD-1A. This set is normally used for tracking meteorological balloons equipped with radiosonde. It operates at a frequency near 1,600 mc.

Sources of Error

The error in signal strength caused by a deviation of the angle between the dipole axis and the direction to the antenna from 90 degrees is less than 20 percent or 1.6 db if the deviation is smaller than 33 degrees (since $\cos 33 \text{ deg} = 1/1.2$). This kind of error may occur during measurement of horizontal polarization if strong winds prevail because of the large drift angle. It can be neglected for most practical purposes if the wind velocity is less than 55 percent of

the velocity of the aircraft relative to the air, assuming the aircraft flies a circle about the antenna (since $\sin 33 \text{ deg} = 0.55$). Under wind conditions of 20 miles per hour or less and an aircraft velocity of 70 mph, no serious errors of this kind can possibly occur.

The specified drag of 40 lb exerted by the wind sock in the case of horizontal polarization, together with the weight of the transmitter of 6 lb, result in an angle of the front half of the dipole against the horizontal of less than 10 degrees. This angle is tolerable because the resulting unwanted vertical component is then more than 22 db lower than the desired horizontal component.

In the case of vertical polarization, the wind drag of the metal ball at the lower dipole end and that of the signal source cause a certain deviation of the upper dipole half from the vertical. Since the total wind drag is less than 4 lb at a speed of 70 mph compared to a total weight of 24 lb this deviation is less than 10 degrees. This corresponds to a horizontally polarized component more than 20 db down from the vertically polarized component.

The deviation of the actual range from the prescribed range is likely to decrease percentage-wise with increasing distance under otherwise similar conditions. It is desirable, therefore, to make the range as large as is compatible with height limitations of the aircraft and tolerable signal-to-noise ratio. The so-called Fresnel-zone condition requires the range to be greater than $2D^2/\lambda$, where D is the lateral dimension of the antenna under test and λ the wavelength. A range of 2 to 3 miles appears to be in order.

It can be shown that the error $\Delta\psi$ in measuring ψ and the resulting

error ΔR in computing R from Eq. 1 are related for small elevation angles by

$$\frac{\Delta R}{R} = -\frac{R}{H} \Delta\psi \quad (2)$$

If, for example, $\psi = 4.8 \text{ deg}$ corresponding to $R/H = 12$, and $\Delta\psi = 1 \text{ deg}$ or $1/57$ radian, then $\Delta R/R$ is 21 percent, corresponding to an error in field strength of 1.6 db.

Height Variation

The effect of an error in measuring or adjusting the height of the aircraft is greatest at low elevation angles, as can be seen from Eq. 1. At an elevation angle of 4.8 degrees, for example, an error in H of 1 foot corresponds to an error of 12 feet in range. Assuming an actual height of 1,330 feet corresponding to a radius of the path flown of 3 miles, an error of 60 feet in height causes an error in range of 5 percent, equivalent to an error in field strength of 0.4 db. This is about the maximum error from this source under favorable conditions.

Approximately six circles, each flown at a different altitude, corresponding to the elevation angles 5, 10, 17, 25, 35 and 45 degrees, for example, are usually sufficient to check the actual pattern against the theoretical pattern. It takes an aircraft flying 70 miles per hour 11 to 16 minutes to complete one circle of from 2 to 3 miles radius, respectively. This amounts to a total flying time, including ascend and descend, of about 3 hours for a complete pattern of one polarization component.

The author thanks W. Todd of Evans Signal Laboratory, the numerous personnel at Coles Signal Laboratory involved in this development, the helicopter crew and the crew operating the tracking equipment for their contributions.

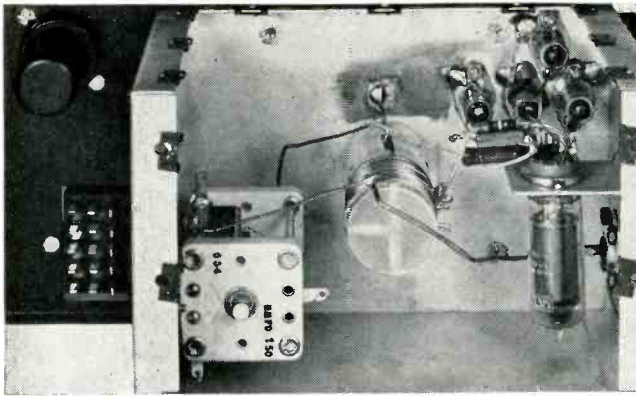

Rear view of r-f oscillator and regulator

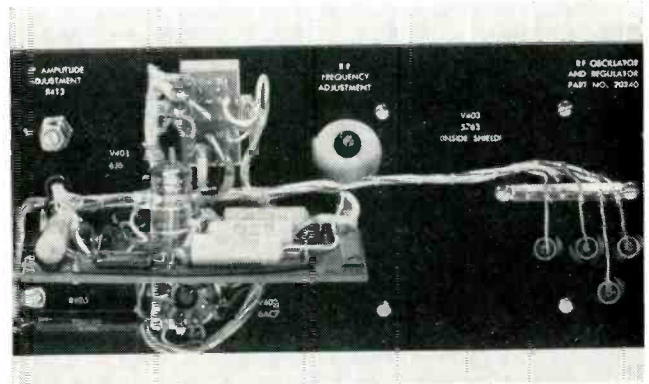

Front view showing adjustments through openings

Spectrometer Regulator Stabilizes R-F

SUMMARY — Constancy of radio-frequency voltage amplitude for linear accelerator used in r-f mass spectrometers must be held to 0.01 percent over a wide frequency range. An electrometer tube technique can be employed that insures pure waveform from 2 to 6 mc. Output voltage of 125 volts peak r-f drives a 250- μ f capacitive load

By **WALTER DONNER**

*Chief Project Engineer
Beckman Instruments, Inc.
Fullerton, Calif.*

FOR SEPARATING charged particles as a function of their mass-to-charge-ratio (m/e) a mass spectrometer may be used. In conventional instruments positively charged ions are formed by bombardment with an electron beam in an ion chamber to which the sample gas has been admitted. The particles are then accelerated, collimated and allowed to pass through a magnetic field at right angles to their trajectories. The ion trajectories will be bent into an arc.

With a given accelerating voltage and magnetic field, ion trajectories will be a function of mass. By plac-

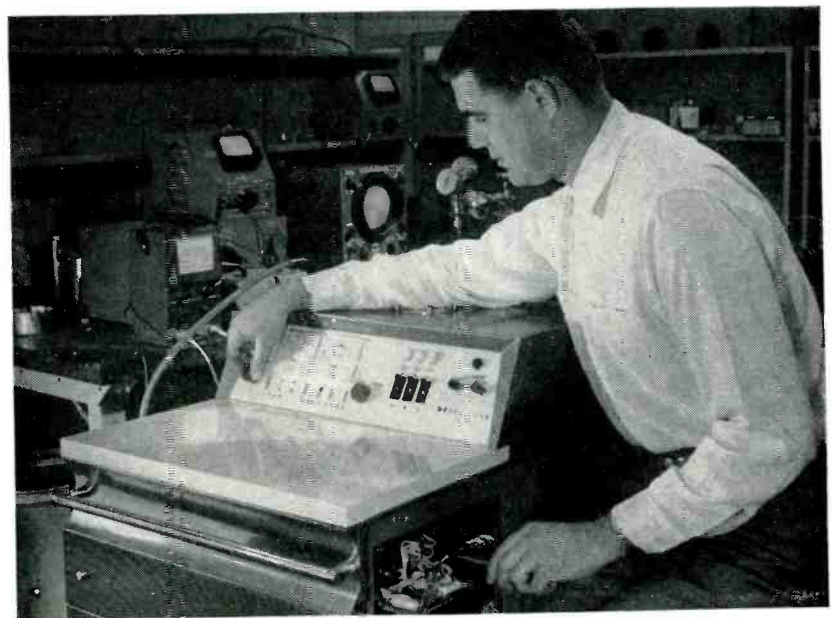

Engineer makes final adjustment to leak detector that uses mass spectrometer technique of determining minuscule amounts of gas

ing a collector plate behind a resolving slit at a suitable location, only a particular mass will be collected.

R-F Spectrometer

Another method of separating masses utilizes a linear accelerator instead of a magnetic field for mass separation. As shown in Fig. 1, ions are formed by electron bombardment within an ion chamber and accelerated by a voltage V . The particles then pass successive gaps upon which an r-f voltage is applied.

If the particles arrive at the first gap at the proper time of the r-f cycle and if they are traveling at the proper velocity so that they can just traverse the gap in a half-cycle of r-f, they will be accelerated and will gain the energy of the r-f. The velocity v of a particle of charge e is

$$v = (2eV/m)^{1/2}$$

so it is seen that for a given frequency and gap length only a particular mass can traverse the gap and pick up the maximum energy. A greater separation in mass can be resolved by utilizing more gaps in cascade, each gap being successively longer by the increase in velocity predicted by the system.

Once the particles are separated in kinetic energy by the r-f analyzer, a pair of deflection plates can serve as a kinetic energy selector. The amount of deflection is inversely proportional to the kinetic energy, the particle paths being independent of mass in an electrostatic field. If

the particles are injected at an angle of 45 deg into the electrostatic field, a first order focusing is achieved (Fig. 2). For a parallel beam, the ratio of beam widths at the top of the parabolas with respect to the entrant width is $\Delta h^2/2d$, where $2\Delta h$ is the entrant beam width and d is the distance between the deflecting plates.

Oscillator Design

An output voltage of 125 volts peak r-f is required on the accelerator. Since the accelerating structure within its case looks like 250 $\mu\mu\text{f}$, it is necessary to use a capacitive voltage divider across the oscillator tank to vary frequency over a range of 3 to 1. It is desirable to vary the capacitance of the LC tank in changing frequency since this produces a linear mass scan if a linear capacitance change is used.

A variable air capacitor with a maximum-to-minimum capacitance of 25 to 1 was selected for tuning. With the capacitive load of the tube lumped on the tank through a 10-to-1 capacitive divider shown in Fig. 3, a frequency range of 3 to 1 is obtained (capacitance range of 9 to 1).

To produce 125-volt signal at the tube requires a 1,250-volt signal across the tank, owing to the capacitive divider. This is achieved using a Lampkin oscillator circuit with a coil whose Q is over 350. An effective step-up transformer is thus produced, requiring less than 300

volts plate and screen voltages. Since no power is required from the oscillator, a pair of 5763 tubes is sufficient for conservative operation, the output voltage being proportional to the g_m .

The screen voltage is used as the variable element for maintaining the amplitude constant as the frequency is varied. The screen voltage change for change in frequency is inversely proportional to the Q of the tuned circuit as a function of frequency. The frequency range used is from 2 to 6 mc.

R-F Regulator

The problem of measuring the r-f amplitude to 0.01 percent is indeed difficult. No diode rectifier is free enough from variable contact potentials to make a 125-volt measurement to 12.5-mv accuracy. Germanium diodes, although having less contact potential, are temperature sensitive and therefore also useless.

An electrometer tube circuit shown in Fig. 4 provides a reasonable way to achieve the measurement. A type CK5886 tube was selected because the large grid-to-cathode spacing allows the application of 120 volts bias on the tube. The stage is used as a plate detector, the r-f signal being applied at the grid on top of a 120-volt bias voltage.

The tube conducts for only a small portion of the r-f cycle and the filtered d-c plate voltage is a

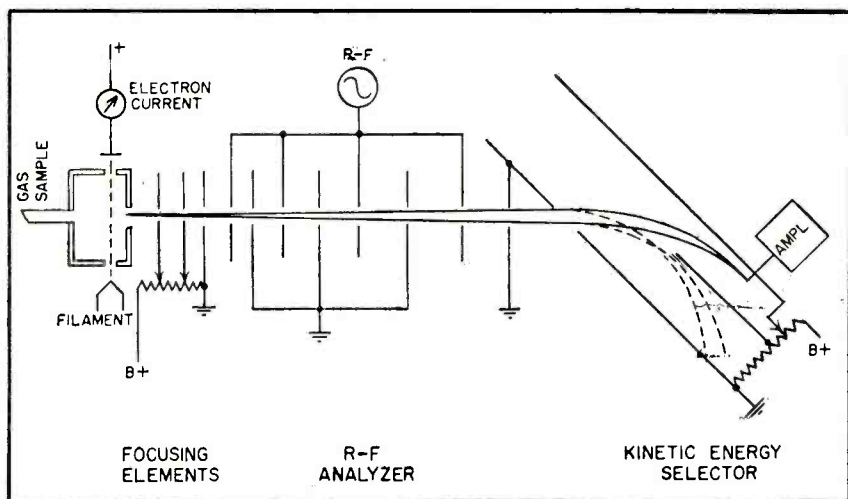

FIG. 1—Six-gap i-f accelerator mass spectrometer

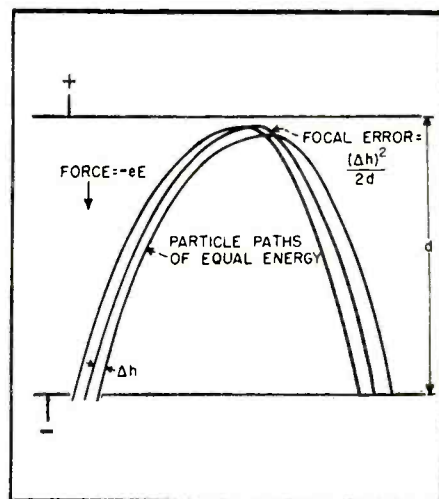

FIG. 2—Charged particle paths

function of the r-f amplitude. Plate and screen voltage are operated at 10 volts with respect to cathode to reduce grid current and ion currents. The bias stability can be kept to better than 2 mv a day, a factor of 10 below the required 12.5 mv bias stability required for the system.

The plate load is returned to

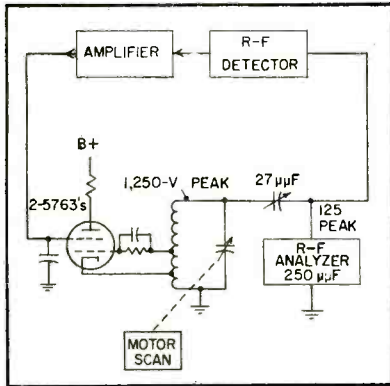

FIG. 3—Oscillator with regulator

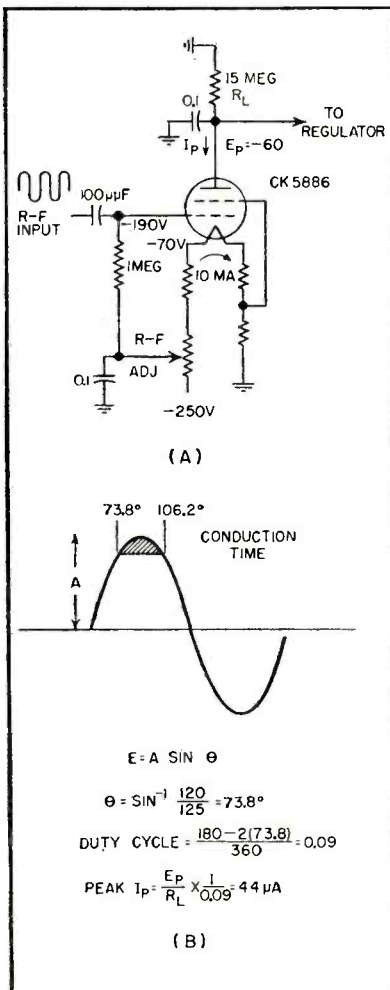

FIG. 4—Radio-frequency detector (A) and operating characteristics (B)

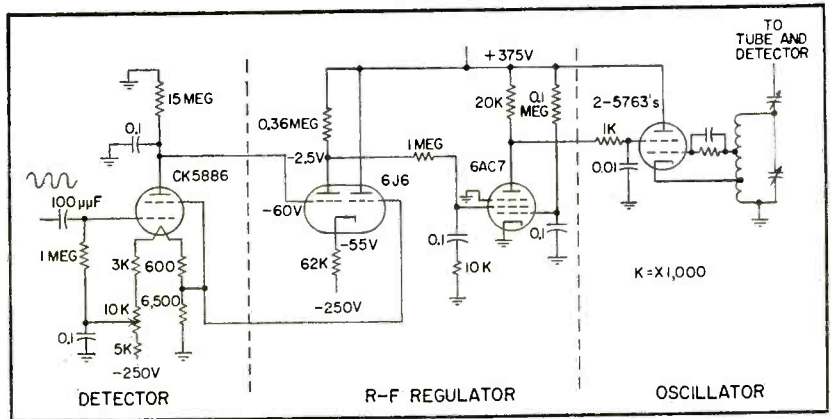

FIG. 5—Assembled circuits showing detector, r-f regulator and oscillator

ground potential to reduce d-c variations and the grid and cathode are both common to a well-regulated -250 volt supply. To stay within peak plate current ratings on the CK5886, a 15-megohm plate load is used. Since this represents the grid resistor of the following 6J6 stage, the second stage shown in Fig. 5 must also be designed with low plate voltage to reduce grid current. A 6J6 was selected since it can operate with low plate voltages and still have a suitable bias for the application.

The loop gain required can be computed on the basis of the number of stages used and an arbitrary figure of ± 12 percent variation in gain per stage. For 0.01-percent stability, half the difference between the extreme values of $1/AB$ corresponding to the ± 36 -percent variation of A about A_0 for three stages must be 0.0001 or less. Therefore

$$0.0001 = \frac{1}{AB} \times \frac{1}{2} \left(\frac{1}{0.64} - \frac{1}{1.36} \right)$$

$AB = 4,130$ where AB is the loop gain

For commercial equipment this value is arbitrarily multiplied by 10 to give a good safety factor. With three stages, the second stage must be a differential amplifier for the loop to maintain correct phase relationship so that an increase in r-f amplitude will decrease screen voltage and so that a good voltage gain at d-c can be achieved without cathode degeneration.

The third stage is used as a shunt regulator with its cathode grounded. A large variation in plate current

will therefore not upset the bias characteristics. Phase-compensating networks have been added to prevent oscillation and yet maintain response of the amplifier to several hundred cycles.

The performance of the r-f regulator is good, maintaining amplitude stability to 0.001 percent as the frequency varies from 2 to 6 mc. The long term stability is 0.01 percent. Since the linear accelerator is in a sense an r-f voltmeter, the final energy being equal to $V_0 + nE$, it makes an excellent means of checking the amplitude stability of the r-f applied to its plates.

Argon Check

For example, if an argon sample is admitted to the spectrometer, peaks will occur at masses 40, 38 and 36, corresponding to the argon isotopes. The ratio of the peak heights of the isotopes is known to better than 0.01 percent and since the peak heights on the r-f accelerator instrument are also a function of the amplitude stability of the r-f, a good check on the operation of the regulator can be made as a function of frequency.

In making measurements of an r-f voltage of variable frequency to 0.01 percent, it is necessary that the detector be mounted with as short a lead as possible to the analyzer, since the inductance of even a short piece of wire combined with the capacitance of the analyzer forms a resonant circuit at several hundred megacycles. Thus, the transfer characteristic will be a function of frequency.

Matrixing and Encoding

SUMMARY — Single encoded composite video signal appears at the output terminals of unit that combines color television signals under the NTSC system and feeds tv transmitter without distortion of any signal element

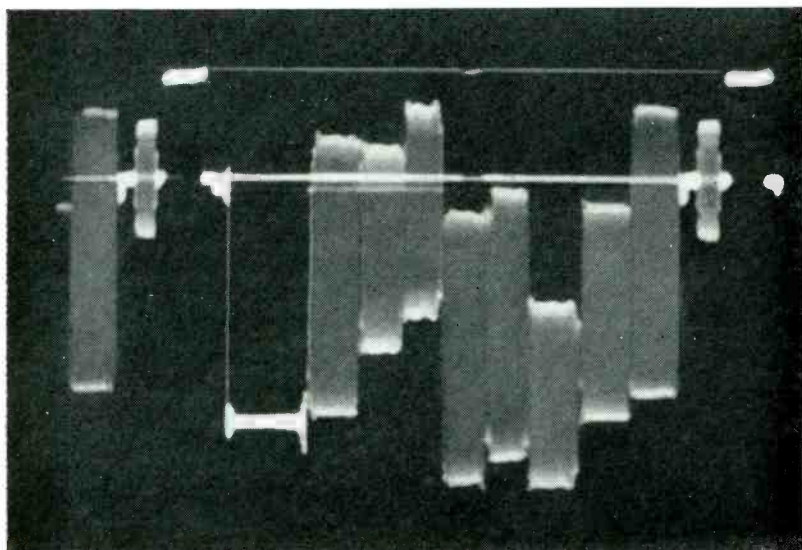

Signal at output of matrix and encoder unit in response to color-bar generator signal input

THE NTSC SYSTEM of color television transmission specifies that a composite video signal shall contain in separable form: a luminance signal which can be utilized by existing monochrome receivers to give a normal black and white picture and a two-component chrominance signal, which together with the luminance signal, conveys the complete color information.

Each of these signals is normally composed of a linear combination of the gamma-corrected red, green and blue signal outputs of a color camera, slide scanner or color-bar generator. Since the luminance and two components of the chrominance signal must be transmitted over a common communication channel, these signals must be distinguished from one another. The chrominance signal is superimposed as a modu-

lation on a subcarrier signal. The individual chrominance components are in turn distinguishable because their respective subcarrier signals are in phase quadrature.

The subcarrier must be transmitted at periodic intervals to provide the reference against which the phase of the chrominance signal may be compared. Modulation is accomplished in a balanced modulator to secure the advantages of a disappearance of the subcarrier in the absence of color. To minimize crosstalk between luminance and chrominance signals and between the components of the chrominance signals bandwidth limiting is required of the chrominance components before modulation.

The unit to be described accepts as inputs a blanking signal, a sync signal, a subcarrier signal, a burst-

key signal and the red, green and blue color signals. The unit performs the necessary operations of matrixing, modulation, bandwidth limiting, subcarrier reference-signal insertion and addition of blanking and sync signals.

Operational Stability

Feedback is used in all amplifier stages of this matrix and encoder unit to assure stability of gain and linearity of operation. In the modulator stages feedback is not easily achieved. Here the problem of stability is met by operating these stages at a high signal level. The drive signals, sync and blanking, are amplified and passed through limiting stages. This insures that the waveform and amplitude of these signals, as they appear at the output, are insensitive to amplitude and waveshape at the inputs.

NTSC Specifications

The NTSC specifications, that are relevant in the present discussion are given in Table I, Eq. 1 through 4. The symbols R , G and B represent respectively the gamma-corrected amplitudes of the signals furnished by the red, green and blue cameras and have a maximum amplitude of unity. The symbol Y represents the luminance signal, while I and Q represent the amplitudes of the two quadrature subcarrier voltages that convey color information. Finally, the symbol E represents the total video signal.

In the absence of color, $I = Q = 0$, the subcarrier amplitude is required to be zero. This feature requires that the modulators operate

as balanced modulators and hence furnish zero output in the absence of modulation. A pure luminance signal results when the R , G and B camera signals are of equal amplitude. Note in the derived relationships in Table I, Eq. 5 through Eq. 8 that $I = Q = 0$ when $R = G = B$.

The Y signal bandwidth is limited only by channel space allotted, while, as noted in Table I, the I and Q signals are restricted to bandwidths of 1.3 mc and 0.5 mc respectively.

The color-bar signal chart of Table II specifies the amplitudes of camera signals that give rise to maximum amplitude of the color signals listed in the column labeled signal. The subcarrier phase is specified with respect to the phase of the reference burst whose phase is arbitrarily specified to be 180 deg. The information in the last two columns of the chart is also given as a sinor diagram in Fig. 1.

In Fig. 2 the appearance of the composite video signal on a line basis, that is, from one horizontal sync pulse to the next is shown. The solid line represents the luminance signal which serves as the pedestal upon which the subcarrier signal is superimposed. The dotted lines represent the peak positive and negative excursions of the subcarrier signal. The reference phase burst is nominally eight cycles in duration and sits on the back porch of the horizontal blanking pulse. For convenience, black level has been set arbitrarily at zero. The small separation between blanking level and black level is referred to as set-up.

Matrixer and Encoder

Each of the camera input signals is fed directly to the Y -matrix as shown in Fig. 3. The Y -matrix, composed purely of resistors, provides at its output a linear combination of the R , G and B signal, which is proportional to the signal Y as given in Table I. From Eq. 5 and 6 note that it is possible to form I and Q signals in a matrix, the input signals to which are the R , G and B signals. Such an arrangement would require the use of two inverting amplifiers to provide the signals $-G$ and $-B$.

These inverting amplifiers would then be required to have a high de-

gree of gain stability and freedom from distortion. The gain stability is needed to assure accuracy in the matrixing. Freedom from distortion is required so that $I = Q = 0$ when $R = G = B$. If either of the inverting amplifiers produces some harmonic components of the input signals, these harmonic components will constitute a residual in the I and Q channels when, in principle, no chrominance signal should be present. Thus the I and Q signals are formed on the basis of the alternative formulations given by Eq. 7 and 8. Now only the Y signal need be inverted.

The Q signal from the Q -matrix is passed through a bandwidth-limiting filter and then into the Q amplifier. The signal is amplified and converted finally into the symmetrical signal required for the push-pull operation of the Q modu-

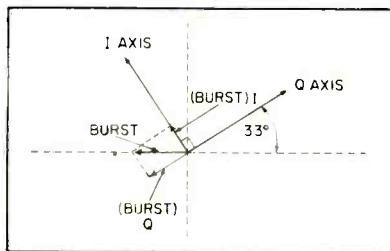

FIG. 4—Burst signal generated by simultaneous unbalance of the I and Q modulators

lator. The I signal from the I -matrix is treated in an identical fashion with the single exception that the I signal passes additionally through a length of delay cable. This delay is required because the delay in the Q filter is appreciably larger than the delay through the I filter. The NTSC specifications require that all components that contribute to the final video signal must be delayed by an equal amount to a tolerance of $\pm 0.05 \mu\text{sec}$. This requirement also accounts for the delay introduced into the sync, blanking and burst-key channels.

In addition to the I and Q video signals, which are fed to their respective modulators, each modulator also receives a push-pull 3.58-mc subcarrier signal. This subcarrier signal, provided by a color sync generator, is amplified and limited in a two-stage tuned amplifier so its amplitude at the modu-

Table I—NTSC Specifications Relevant to Matrixing and Encoding Unit and Derived Relations

NTSC SPECIFICATIONS	
(1)	$E = Y + [Q \sin(\omega t + 33^\circ) + I \cos(\omega t + 33^\circ)]$
(2)	$Y = 0.30R + 0.59G + 0.11B$
(3)	$I = -0.27(B - Y) + 0.74(R - Y)$
(4)	$Q = 0.41(B - Y) + 0.48(R - Y)$
DERIVED	
(5)	$I = 0.599R - 0.2773G - 0.3217B$
(6)	$Q = 0.213R - 0.5251G + 0.3121B$
(7)	$I = 1.472R + 1.449G - 2.925Y$
(8)	$Q = 0.480R + 0.410B - 0.890Y$
Q-Channel Bandwidth	
At 400 kc less than 2-db down	
At 500 kc less than 6-db down	
At 600 kc at least 6-db down	
I-Channel Bandwidth	
At 1.3 mc less than 2-db down	
At 3.6 mc at least 20-db down	

lators is independent of variations at the subcarrier input jack. The subcarrier is applied directly to the I modulator and phase shifted by 90 deg before application to the Q modulator.

The output of each modulator is a balanced, a-m signal. The amplitude in one case is proportional to the I signal; the amplitude in the other case is proportional to the Q signal. The two outputs are added in a common plate load. Since the two outputs are in quadrature, the resultant signal is one that is modulated in both amplitude and phase. The phase indicates the relative amounts of I and Q while the amplitude, $(I^2 + Q^2)^{1/2}$ is related to the amount of chrominance signal. For a purely black and white scene there would be no output from the modulators and a signal would appear only in the luminance channel.

Owing to the slight but inevitable nonlinearity of operation of the modulators, second and higher harmonics of the subcarrier are generated, which must be eliminated. For this purpose, the modulated subcarrier is passed through a low-pass filter. The frequency response from the plates of the modulators to the composite video output jack is uniform to within 1 db up to 5 mc and negligible at 7.16 mc ($2 \times$ subcarrier) and thereafter.

The color burst constitutes the phase reference for the chromi-

Table II—Color Bar Signal Chart

SIGNAL	R	G	B	Y	SUBCARRIER Amplitude	Phase
R	1	0	0	0.30	0.635	103.42°
RG (Yellow)	1	1	0	0.89	0.447	167.13°
G	0	1	0	0.59	0.593	240.83°
GB (Cyan)	0	1	1	0.70	0.635	283.42°
B	0	0	1	0.11	0.447	347.13°
BR (Magenta)	1	0	1	0.41	0.593	60.33°
RGB (White)	1	1	1	1	0
B - Y	0.1571	0	1	0.1571	0.4135	359.63°
(R - Y = 0)	0.5371	0	1	0.2711	0.4265	33°
(I = 0)	1	0	0.3371	0.3371	0.5848	90.03°
(B - Y = 0)	1	0.4056	0	0.5393	0.4865	123°
(Q = 0)	1	0.7317	0	0.7317	0.4313	146.38°
(G - Y) 90°	1	0.7317	0	0.7317	0.4313	146.38°
(G - Y = 0)	0.8429	1	0	0.8429	0.20	180°
Color Burst	0.8429	1	0	0.8429	0.4135	179.63°
-(R - Y = 0)	0.4629	1	0	0.7289	0.4265	213°
-Q	0.4629	1	0	0.7289	0.4265	213°
(I = 0)	0	1	0.6629	0.6629	0.5848	270.03°
-(R - Y)	0	1	0.6629	0.6629	0.5848	270.03°
(B - Y = 0)	0	0.5944	1	0.4607	0.4865	303°
-I	0	0.5944	1	0.4607	0.4865	303°
(Q = 0)	0	0.2683	1	0.2683	0.4313	326.38°
-(G - Y) 90°	0	0.2683	1	0.2683	0.4313	326.38°
(G - Y = 0)	0	0.2683	1	0.2683	0.4313	326.38°

nance signal. The NTSC specifications require that on a sinor diagram on which the phase of the burst is 180 deg, that the phase of a pure Q signal shall be 33 deg while the phase of a pure I signal shall be (33 deg + 90 deg) = 123 deg. These phase relations are indicated in Fig. 4. A color burst of proper phase can be generated by unbalancing simultaneously the I and Q modulators so that the relative amplitudes of the modulator outputs are related by the equation

$$\frac{(\text{Burst})I}{(\text{Burst})Q} = -\tan 33 \text{ deg}$$

The burst-key pulse is furnished by a color sync generator and has a duration of nominally eight cycles of the subcarrier signal. This color pulse is passed through an impedance-matching cathode follower into a delay cable and then through a shaping amplifier. The signal then proceeds through a gain-and-phase-control amplifier. This amplifier provides two burst-pulse outputs and has provision for adjusting independently the relative amplitudes and overall amplitudes of the burst-pulse outputs. The burst pulses are then injected into the I and Q amplifiers through a pair of buffer amplifiers.

Sync and blanking signals are passed through shaping amplifiers to make them independent of the input amplitudes, then mixed to-

gether and added to the Y signal. This composite Y signal is delayed, further amplified and added to the chrominance signal. This forms a composite video signal that is delivered to the output jack through an output amplifier. This output amplifier is adjustable in gain, has excellent linearity and will furnish a 1.4-volt peak-to-peak signal across a 75-ohm load. The output impedance is 75 ohms.

Synchronous clamping circuits are employed at the input to the output amplifier and at the video inputs to the modulators.

Video Amplifiers

Long-time stability results in large measure from use of nega-

tive feedback in all video amplifiers. With the exception of the output stage all are of the form shown in Fig. 5A. The merits of this stage with respect to stability and linearity are apparent through a comparison of the characteristics of this stage with a conventional stage of video amplification as shown in Fig. 5B. The conventional stage has a nominal gain, $A = -g_m R_L$ and an upper 3-db frequency, $f_2 = (2\pi R_L C_o)^{-1}$, C_o being the total capacitive loading of the stage. The cathode compensated stage of Fig. 5A when adjusted so that $R_k C_k = R_L' C_o$ has a gain and 3-db frequency given respectively by

$$A_c = \frac{g_m R_L'}{1 + g_m R_k} \text{ and } f_{2c} = \frac{1 + g_m R_k}{2\pi R_L' C_o} \quad (9)$$

Note from Eq. 9 that in both cases the gain-bandwidth product is the same, $A f_2 = A_c f_{2c}$.

If R_L' in the cathode compensated amplifier is selected to be $R_L' = k R_L$ and R_k is selected so $g_m R_k = k - 1$, then, from Eq. 9, the gain and bandwidth of the compensated stage will individually be equal to the gain and bandwidth of the conventional stage. In the conventional stage a given percentage variation in g_m will produce an equal percentage variation in gain. In the compensated stage however the fractional change $\Delta A_c / A_c$ in gain resulting from a fractional change $\Delta g_m / g_m$ in transconductance is given by

$$\frac{\Delta A_c}{A_c} = \frac{1}{k} \frac{\Delta g_m}{g_m} \quad (10)$$

This result follows from the gain

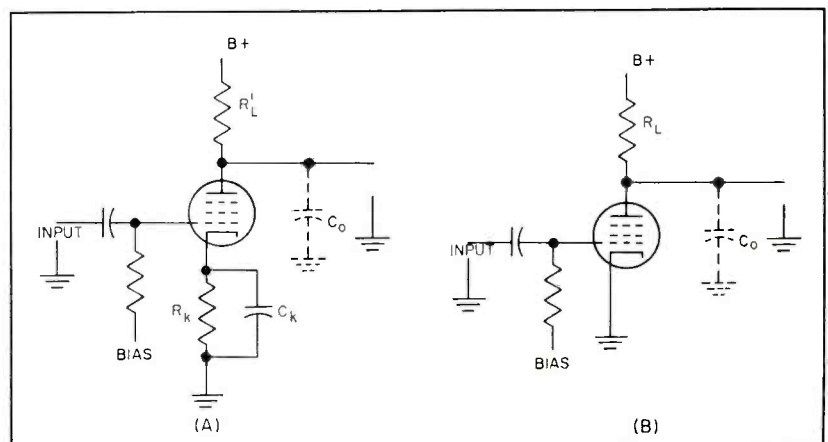

FIG. 5—Cathode-compensated amplifier stage (A) and conventional stage (B)

expression in Eq. 9. The principal source of gain instability in a video amplifier is the variation of g_m resulting from tube aging. Equation 10 indicates that the modification of a conventional amplifier in accordance with the procedure given above will preserve gain and bandwidth and reduce gain drift by the factor k .

Another advantage of the use of cathode compensation is a reduction of the nonlinearity of the amplifier. In a conventional amplifier nonlinearity of operation results essentially from the fact that the transconductance is a function of tube current and that, as a consequence, the amplifier gain varies over the range of the signal excursion.

Reduction of distortion may also be seen from the following considerations. Suppose that a peak-to-peak output signal E is required. In a conventional amplifier the tube must swing through a current range ΔI such that $R_L \Delta I = E$. In the compensated amplifier, since $R_L' = kR_L$, the tube is only required to swing through a current range $\Delta I/k$ and

hence through a correspondingly smaller range of transconductance.

The output amplifier is of the type developed by Peterson and Sinclair and is illustrated in Fig. 6. Tube V_1 serves as a phase inverter to provide push-pull signals to the grids of V_2 . In the quiescent condition the currents through V_{2A} and V_{2B} are equal and the load current is zero. A signal excursion at the grids of V_2 causes a current change, say ΔI , in V_{2A} and a current change $-\Delta I$ in V_{2B} . The difference current $2\Delta I$ flows through the load. Thus, the output tubes operate effectively in push-pull with a consequent reduction in even harmonic distortion. At the same time the circuit provides the convenience of a single ended output.

Shaper Amplifiers

Shaper amplifiers are used in this unit to standardize certain signals: blanking; sync; and the burst-key signal. The shaper chain shown in Fig. 7 is typical. Composite blanking is fed to the triode section of the 6U8 tube whose output is sufficient to drive the pentode section from clamp to beyond cutoff. The positive peaks of the output of the pentode are clean, free of overshoots and yet sharply rising owing to the rapidity with which the tube was driven to cutoff. The final stage of this chain, V_2 , is driven from zero bias to beyond cutoff. Direct coupling to the grid of this stage insures that no overshoots will be generated due to grid-current charging of coupling capacitors. The output of this stage is clean on both ends, independent of the amplitude of the

input blanking signal and suitable for mixing into the luminance channel. Gain control of the signal is accomplished by varying the screen voltage of V_2 which controls the plate-current swing for a given grid-voltage swing.

The balanced modulator provides an output subcarrier signal whose amplitude is proportional to the video input signal and is zero when the video signal is zero. The basic modulator circuit is shown in Fig. 8.

If the two tubes are operating identically, and if the input signals are perfectly balanced, there will be zero output in the common plate load. If, due to asymmetries of circuit components or tubes or unbalance of subcarrier signals, output is obtained for zero video input, control R_2 may be adjusted to give zero output. If an unbalance exists that results in a video signal appearing at the output the video gains of the two sides may be equalized by adjusting R_1 .

Varying the bias on grid 1 affects sharply the total space current. Grid 3 controls the partition of this current between plate and screen. For a given voltage swing on grid 3 the plate-current swing will be greater if the total space current is greater and smaller if the space current is smaller. Hence R_2 , which controls the grid-1 biases, may be used to control the subcarrier output of each side. Changing the bias on grid 1 also changes the video gain of the tube and this appears as a secondary effect.

Adjusting R_1 varies the amount of cathode degeneration of the video gain of each side and there-

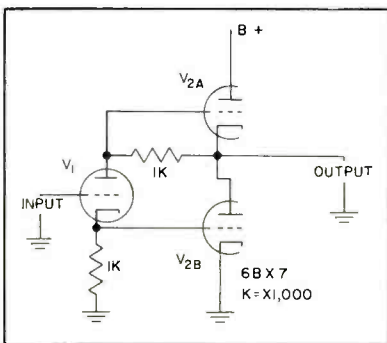

FIG. 6—Composite video output amplifier circuit

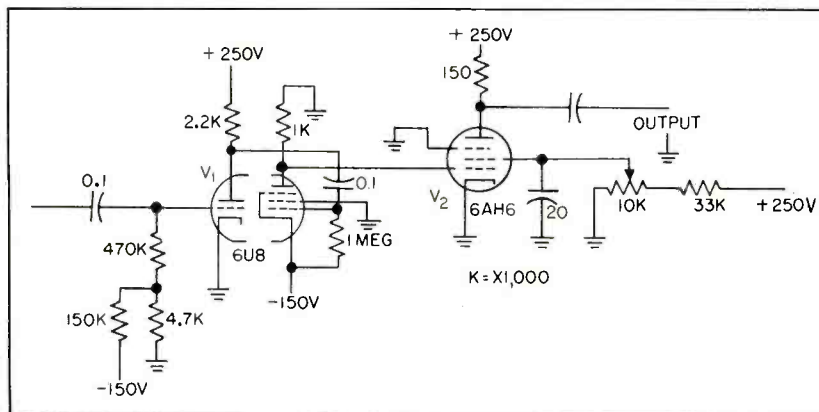

FIG. 7—Composite blanking is fed to the grid of V_1 of the shaper-amplifier chain

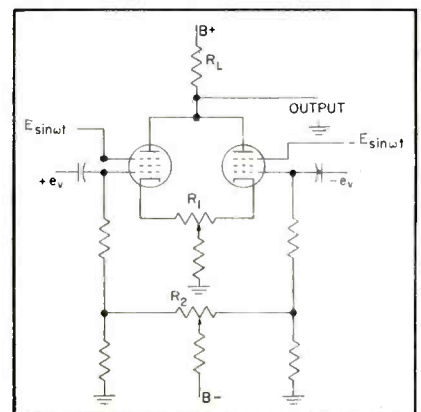

FIG. 8—Basic balanced modulator

fore acts as a video balance. However, it also affects the net grid-1 bias and therefore has the secondary effect of influencing the sub-carrier balance.

Synchronous Clamping

A modulator must provide zero subcarrier output during the blanking interval of its video input. Hence, during this blanking interval the two first grids of a modulator must return to the same voltage level. However, the chroma amplifiers are a-c coupled and the absolute voltage level at the modulator grids individually will be a function of the chrominance-signal duty cycle.

Provision is therefore required for resetting both modulator grids to some common reference voltage during the blanking interval. The problem may not be solved through the use of d-c coupled amplifiers, since the *R*, *G* and *B* camera-input signals are a-c coupled. An examination of Eq. 7 and 8 in Table I shows that the *I* and *Q* signals may make either positive or negative excursions with respect to the zero voltage blanking level and therefore conventional d-c restoration is not suitable. The synchronous clamping circuit of Fig. 9 provides a satisfactory system of d-c restoration.

During the unblanked portion of the line, the diodes are held non-conducting by voltages developed across capacitors C_1 and C_2 . During the blanking interval, pulses are applied to the diodes that force them into conduction and thereby connect the modulator grid through the conducting diodes and resistors *R* to the reference voltage.

If the two clamp signals are alike (but opposite in polarity) there will be no net clamp signal appearing at the modulator grid. Any difference in rise and fall times between the pulses will result in spikes appearing at the modulator grid. Any difference in shape of pulse tops will appear as signal at the modulator grid. Significant differences in pulse amplitude are tolerable.

To obtain pulses as nearly alike as possible, a special pulse transformer has been designed having a pair of bifilar-wound output windings. Two other windings in the

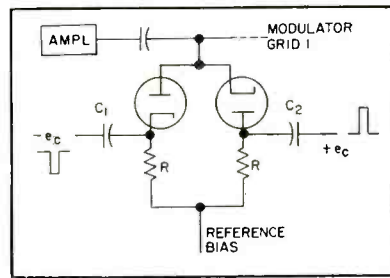

FIG. 9—Synchronous-clamp circuit

transformer are used in a conventional synchronized blocking-oscillator circuit. The synchronizing signal for the blocking oscillator is obtained from composite sync, which has been suitably delayed to match the delays in the chrominance and luminance channels. The blocking-oscillator timing has been so adjusted that, while it is easily synchronized by pulses occurring at line rate, it behaves as a 2-to-1 divider during the interval of the equalizing and serrated vertical pulses. The advantage of this 2-to-1 division is that it avoids a 60-cycle component in the clamping signal.

A synchronous clamp is also used at the grid of the output stage to minimize the required dynamic range of the output amplifier. If the signal applied to this amplifier were a-c coupled in conventional fashion, the average voltage level at the amplifier input would always be zero. As the duty cycle of the signal varies from one extreme to the other, the signal excursion with respect to zero goes positive or negative by an amount equal to the peak-to-peak voltage of the signal. Hence the amplifier is required to handle linearly a signal that is nominally twice the peak-to-peak input amplitude. Where linearity is at a premium, such operation is wasteful. The situation is corrected through the use of a synchronous clamp that restores the voltage at the output amplifier grid to a fixed reference at the end of each line.

The phase-shift circuit is shown in Fig. 10. A signal $E \sin \omega t$ is converted to a pair of push-pull signals by means of a bifilar-wound transformer LL' . To obtain a signal 90-deg out of phase, the original signal is fed to a series resonant circuit LC . The voltage across coil L will lead the input signal by 90 deg. The voltage across L will equal

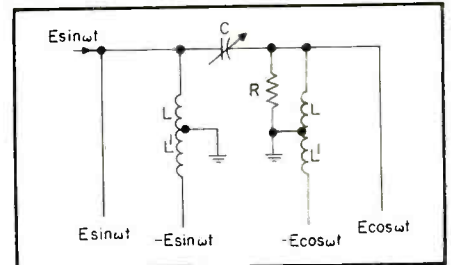

FIG. 10—Ninety-degree phase shift circuit

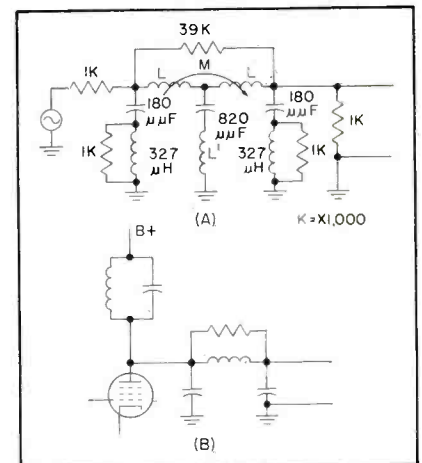

FIG. 11—Q-channel filter has Z_0 of 1,000 ohms (A) and I-channel filter (B)

Q times the input voltage. To make the output equal to the input we make $Q = 1$, that is, $R = X_L$. The actual calculation of R , L and C is complicated by the presence of stray capacitance across C , L and L' and the reflected impedance of L' into L .

I and Q Filters

The filter in the *Q* channel is shown in Fig. 11A. It consists of a single m -derived section and has a characteristic impedance of 1,000 ohms. The resistors shunted directly across the coils are employed for damping purposes to minimize ringing. An m -derived section ($m \cong 1.27$) is employed rather than a prototype section since the former provides a more nearly linear phase characteristic. This improved phase characteristic serves further to reduce ringing.

The *I* filter is of the form shown in Fig. 11B. It consists of a combination of tuned shunt peaking and series peaking. Both *I* and *Q* filters meet the NTSC specifications with a comfortable margin of safety. In both filters the residual ringing and overshoot is small enough to be negligible.

Pulsed Eddy Currents



Experimental setup using crt oscilloscope, left; and closeup of probe, right

Table I—Values of T in Microseconds

Coating Metal	Distance	
	5 mils	25 mils
Aluminum	0.75	18.8
Zirconium	0.045	1.12
347 Stainless Steel	28.1	702.0

SEVERAL methods may be used to measure the thickness of metal coating on a base metal such as: ultrasonics, back-scattering of beta or gamma rays and eddy currents. Eddy currents appear to offer the best chance of success.

If one of the metals is ferromagnetic the problem is simple, but for two nonmagnetic metals the problem is more difficult. Several investigators' have used sinusoidal eddy currents of a single frequency but this method presents difficulties such as low sensitivity and high harmonic content. Echo sounding by pulsed eddy currents² seems to have promise.

Theory

An electromagnetic field is applied to the surface of the coated metal and echoes from the metallic layers received. These echoes are caused by reflection from the metal-to-metal interface separating metals of different electrical properties.

A small single-layer probe coil with its axis perpendicular to the surface of the metal projects the electromagnetic field into the metal and receives the echoes. This helps make point-by-point depth measurements.

The input pulse is shaped like the positive loop of a sinusoidal wave. The path of the waves in the metal is shown in Fig. 1A. The first reflected wave contains information about the surface metal but nothing about the thickness of the coating. If the primary object is to measure

the thickness of the coating, the first reflected wave will not be useful and must be balanced out by a bridge circuit. The second reflected wave contains information about the thickness of the coating and it will be the strongest of the remaining waves.

Pulse Width

The length of the pulses needed is directly related to the basic time

$$T = d^2 \mu_1 \sigma_1$$

where d is the thickness of the coating. Representative values of T in microseconds are given in Table I.

For best results, the input pulse should be approximately five times T . From Table I this would necessitate an extreme range of length of pulses. Some compromise on pulse length is necessary unless only one coating metal and thickness d is to be used. A pulse length of 3 microseconds was used.

The rate generator of an oscilloscope (Tektronix Model 517) is used to trigger a thyatron which

sends identical pulses through both the standard and the test probes. The circuit is shown in Fig. 1B. The responses of the probes are balanced against each other and the difference voltage amplified and reproduced by the oscilloscope. Proper interpretation of the oscilloscope trace will yield the depth of the coating thickness.

When the input pulse from the oscilloscope triggers the thyatron the 1,000- μF capacitor discharges through the thyatron and the primary of the transformer. The resistor in series with the thyatron and the capacitor and resistor shunting the primary of the transformer aid in shaping the pulse. The secondary of the transformer is loosely coupled to the primary and shielded from the primary. The secondary is balanced to ground and the output voltage applied to a bridge. Two of the arms of the bridge are the two probes. The probes are shunted by variable capacitors and resistors which permit

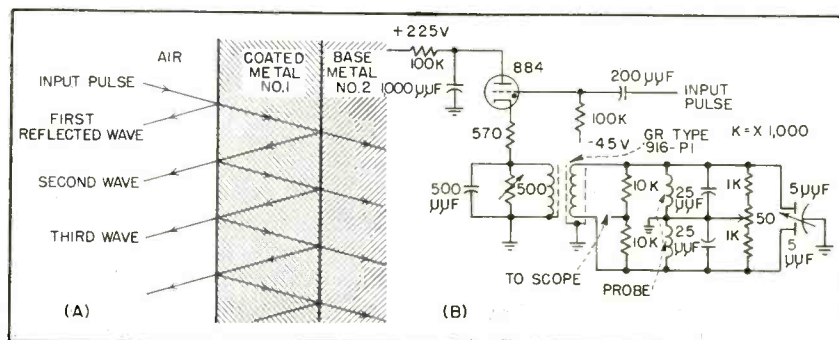

FIG. 1—Wave reflection at metallic interface (A) and pulsing circuit (B)

Gage Plating Thickness

SUMMARY — Echo-sounding technique making use of pulsed eddy currents determines thickness of one metal coated on a base metal. System takes advantage of electrical dissimilarities and is effective even when both metals are nonmagnetic

By **DONALD L. WAIDELICH***

Argonne National Laboratory
Lemont, Illinois

a closer balance. The other two arms of the bridge are 10,000-ohm resistors whose midconnection serves as the output terminal to the oscilloscope.

Operation

If the bridge were perfectly balanced, when the ungrounded end of one probe is driven positively in voltage, the corresponding end of the other probe is driven negatively to the same extent and the output voltage to the oscilloscope would be zero. If a slight unbalance is present, an unbalanced voltage will exist at the terminals of the oscilloscope.

For adequate deflection of the oscilloscope under less sensitive conditions, an additional wide-band amplifier employing distributed amplification is useful.

The probes, shown in the photograph, are about $\frac{1}{2}$ inch in diameter and have a core and outside shell of ferrite (Croloy 70). A single-layer coil of wire is wound on an insulat-

ing tube encasing the core. The resulting coil has an inductance of approximately 250 μ h. Part of the core is movable so that a variable air gap can be introduced in the core to help in balancing the probes. If sufficient sensitivity were available, only the inner core would be used. This would materially reduce the effective area of the probe. The probe is held in plastic and a screw at the bottom adjusts the length of the air gap. An insulating spacer centers the core.

Measurement

The standard sample of metal is placed on the standard probe while another sample of metal is placed on the test probe. The balancing adjustments on the bridge and the probe are made so that the pulse output is nearly zero. A slight unbalance is added by changing the test probe air gap. The result is a wave similar to that of Fig. 2A, left. The gap in the wave is caused by a marker on the oscilloscope

screen. The crossing point of the pulse wave is singled out and the time axis about this point expanded. The resulting wave is shown in Fig. 2B. As the thickness of the coating increases the crossing point moves toward the left. The position of the crossing point may be calibrated in thickness of coating.

One difficulty was the variation of the crossing point with the probe spacing. It was found experimentally that the slope of the oscilloscope trace varied also with this probe spacing. If the distance between the probe and the plate were varied until the slope of the trace had some fixed value, then the probe spacing would always be the same and the crossing point would measure coating thickness.

The results are shown in Fig. 2, right. The solid line is the calibration curve of the oscilloscope. The two encircled points are those of standard samples used for calibration.

The test sample was tested by the oscilloscope method and then was sectioned for optical measurements. The crosses are the results of optical measurements. They indicate good agreement between the nondestructive and destructive tests.

REFERENCES

- (1) R. Hochschild, Eddy Current Testing by Impedance Analysis, *Nondestructive Testing*, 12, p 35, May-June 1954.
- (2) D. L. Waidelich, Coating Thickness Measurements Using Pulsed Eddy Currents, *Proc NEC*, 12, Feb. 1955.

*Now at University of Missouri, Columbia, Mo.

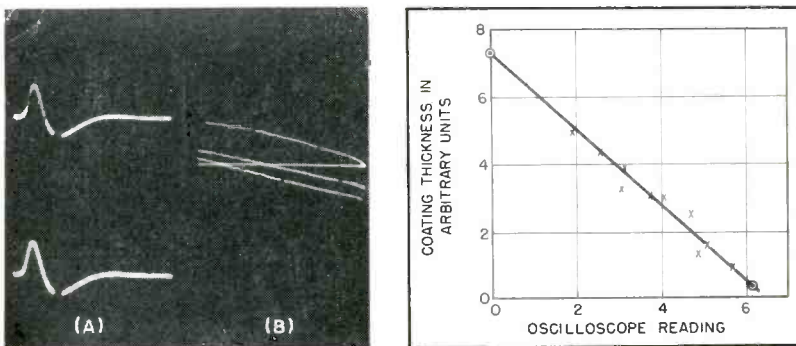

FIG. 2—Output waveform on crt (A), expanded trace (B) and coating thickness as a function of crt reading, right. Crosses indicate optical measurements

Table I—Linearity Measurements, Resistor R_c Adjusted for Zero Frequency Error at Dial Setting of 9

Correct Dial Reading	Frequency with Respect to Highest Frequency of Each Range	Actual Dial Reading with No Compensation			Actual Dial Reading with Compensating Resistor ($R_K = 1$ Meg)		
		5 to 50 pps, $R_c = 10.5K$	50 to 500 pps, $R_c = 10.5K$	500 to 5,000 pps, $R_c = 11.5K$	5 to 50 pps, $R_c = 10.5K$	50 to 500 pps, $R_c = 10.5K$	500 to 5,000 pps, $R_c = 11.5K$
0	$f/10$	0	0	0	0	0	0
1	$f/9$	1.02	1.0	1.0	0.99	0.995	0.995
2	$f/8$	2.02	2.0	2.0	1.99	1.99	1.99
3	$f/7$	3.02	3.01	3.01	2.99	2.99	2.99
4	$f/6$	4.03	4.01	4.01	3.99	4.0	4.0
5	$f/5$	5.02	5.02	5.01	5.0	5.0	5.0
6	$f/4$	6.02	6.01	6.01	6.0	6.0	6.0
7	$f/3$	7.01	7.01	7.0	7.0	7.0	7.0
8	$f/2$	8.01	8.0	8.0	8.0	8.0	8.0
9	f	9.0	9.0	9.0	9.0	9.0	9.0

Repetition-Rate Generator

SUMMARY — Free-running double screen-coupled phantastron covers range of 5 to 5,000 pps in three ranges with 2-percent accuracy. Compensating circuits improve basically linear operation of phantastron and ten-turn potentiometer frequency control assures reproducible indication

By **FRED A. PLEMENOS***

*Raytheon Manufacturing Company
Missile & Radar Division
Bedford, Massachusetts*

ALTHOUGH in many instances a free-running multivibrator can be used to control the repetition rate of a pulse generator, accurate settings can not be made easily because the timing of the multivibrator period is determined by an exponential rather a linear waveform.

The phantastron repetition-rate generator to be described covers the range of 5 to 5,000 pps in three ranges with 2-percent accuracy. Timing is determined by the linear plate voltage rundown waveform.

Circuit Operation

Use of a double screen-coupled phantastron, in which two single screen-coupled monostable phantastrons are cross coupled, results in linear operation and thereby accurate timing over the complete

period, which consists of two linear rundown waveforms.¹

In the circuit of Fig. 1, V_1 and V_4 are pentodes with suppressor-grid control. Both halves of the circuit, if considered independently, are conventional monostable screen-coupled phantastrons. Both suppressors are biased substantially below cutoff and either a positive trigger on the suppressor or a negative trigger on the plate is required to initiate the action for each rundown. Considering both halves as operating together, however, the cross coupling between the two circuits will maintain free-running operation once started. When the circuit is turned on, some slight disturbance is enough to start a rundown in one of the two sections. During this rundown period, screen current in the tube of that section

is very low and the screen voltage is high.

At the end of the rundown, the plate current decreases and the screen current increases rapidly, causing the screen voltage to fall. Since each screen waveform is differentiated and coupled to the plate of the other 6AS6, a negative trigger will be coupled to the opposite plate at the end of the first rundown and another linear rundown will be initiated maintaining free-running operation.

Tubes V_2 and V_3 are cathode-follower low-resistance recharging paths for the grid-to-plate coupling capacitors. Without the cathode follower, the plate coupling capacitors would have to recharge through the large plate resistor R_L , resulting in

*Formerly with Browning Laboratories, Inc., Winchester, Mass.

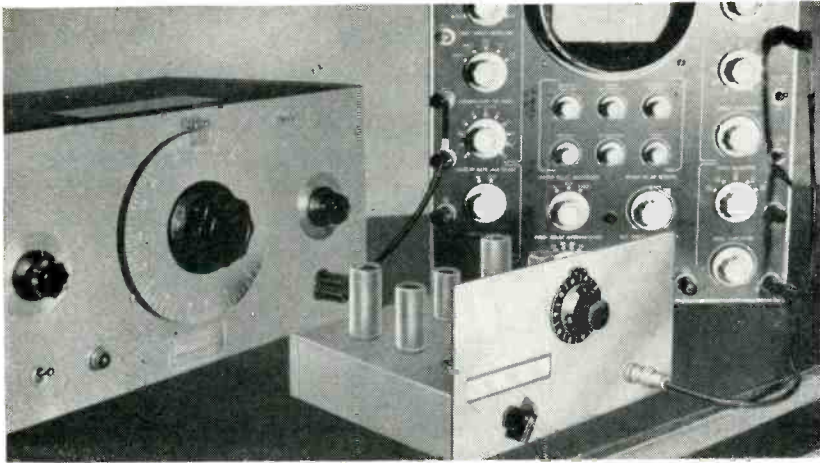

Setup for testing repetition-rate generator uses a-f generator and oscilloscope

Has High Accuracy

a long recovery time determined by the time constant $R_L C$. Using the cathode-follower recharge path, however, the recovery time constant becomes approximately $(1/g_m) C$, which is completely adequate in most cases.

Tubes V_3 and V_6 clamp the plates at a voltage level of 200 to 20 volts, as determined by the helical potentiometer. As the rundown in either of the sections begins, its own clamping diode disconnects allowing that plate potential to go down.

Frequency Ranges

There are three frequency ranges: 5 to 50 pps; 50 to 500 pps; 500 to 5,000 pps. Since frequency is inversely proportional to period and period is proportional to clamping level, for a particular grid-circuit time constant $R_C C$, a setting of a 200-volt clamping level will correspond to the lowest frequency of each range and a setting of a 20-volt clamping level will correspond to the highest frequency of each range.

The V_1 suppressor waveform (Fig. 2A) is differentiated and applied to V_6 , a heavily conducting amplifier stage. Thus, a positive trigger output at the plate of V_6 is obtained for each cycle of operation of the phantatron circuit. By using a 6AH6 sharp cutoff pentode

as V_6 , a 70-volt trigger with a 0.4- μ sec rise time can be obtained.

Typical rundown plate waveforms for V_1 , Fig. 2, show that the plate rundown waveforms are essentially linear. These plate waveforms also show the initial step which is characteristic of this type of cir-

cuit. In Fig. 2B, the step is only a small fraction of the total rundown amplitude so that the ratio of T_2 (actual period) to T_1 (sawtooth period) is close to unity.

In the plate waveform of Fig. 2C, obtained at low clamping levels, the initial step becomes an appreciable part of the rundown and the ratio of T_2 to T_1 becomes noticeably less than unity. Thus a linear control of clamping level with a precision helical potentiometer does not linearly control period.

Compensating Circuits

One method of compensating for this nonlinearity is to introduce another nonlinearity elsewhere. An inherent nonlinearity exists in the actual clamping level since the trigger-isolating resistor R_C shown in Fig. 3 introduces a voltage which is in series with the desired clamping voltage. At first, it seemed desirable to make R_C as small as possible to reduce this source of nonlinearity. However, voltage drop e_c shown in Fig. 3 increases as the clamping level decreases. The step in the waveform introduces one nonlinearity which tends to decrease the period and the voltage

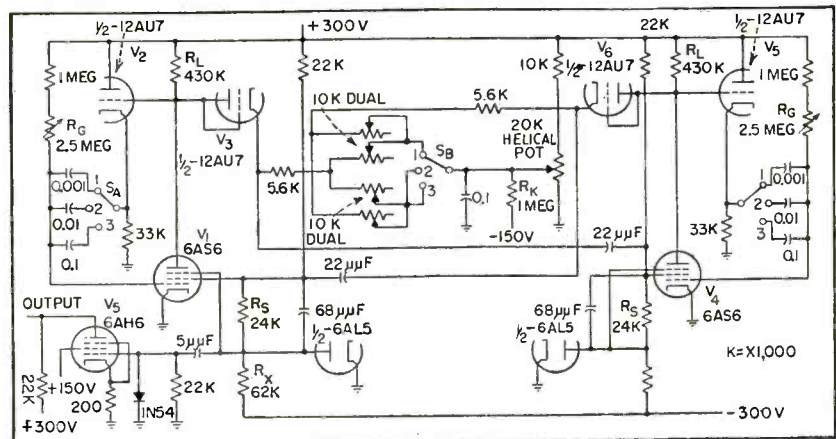

FIG. 1—Frequency ranges for switch positions 1, 2 and 3 are 500 to 5,000, 50 to 500 and 5 to 50 pps. Two R_C controls are mounted on common shaft

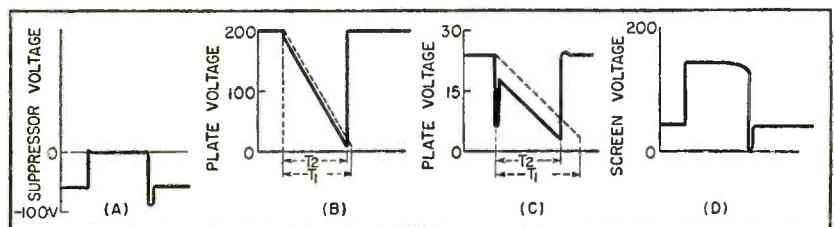

FIG. 2—Typical waveforms for V_1 in Fig. 1. Rundown waveform (B) is obtained with a 500-pps repetition rate and (C) with a 5,000 pps rate

Table II—Linearity Measurements for Two Highest Frequency Ranges of Circuit of Fig. 1

Repetition Frequency (pps)	Period (μ sec)	Correct Dial Reading for All Ranges	Actual Dial Reading (50 to 500 pps)	Actual Dial Reading (500 to 5,000 pps)
50	20,000	0	0	0
100	10,000	5.00	5.0	5.0
150	6,670	6.67	6.66	6.67
200	5,000	7.50	7.49	7.50
250	4,000	8.00	8.0	8.01
300	3,330	8.33	8.33	8.34
350	2,860	8.57	8.57	8.58
400	2,500	8.75	8.75	8.76
450	2,220	8.90	8.89	8.90
500	2,000	9.00	9.0	9.00

drop across R_c introduces a non-linearity which tends to cancel the former by tending to increase the period.

By proper adjustment of R_c (combination of 5,600-ohm fixed resistor and 10,000-ohm dual potentiometer), reasonably good compensation can be achieved. This compensation is not perfect, but in combination with another compensation to be described excellent results can be obtained. One adjustment for R_c suffices for the two lowest frequency ranges. A separate adjustment and therefore a separate dual potentiometer is required for the 500 to 5,000 pps range.

Leakage Conduction

In addition to the error introduced in the clamping level by the voltage drop across R_c , there is an error introduced in the clamping level by conduction from B+ to ground through plate resistor R_L , the catching diode and helical potentiometer. This error is minimized by making the value of resistance of the helical potentiometer small enough so that much more current flows through the poten-

tiometer from the clamping divider than flows through the potentiometer from the catching diode. In Fig. 3 this error is listed both as an absolute error and a percentage error for several settings of the potentiometer.

Percentage error in clamping level from this source is plotted against helical-potentiometer setting as the uncorrected curve in Fig. 4.

By introducing R_k as shown in Fig. 4, the value ($I_c - I_k$) can be made to equal zero at some setting of the potentiometer, depending upon the value of R_k . Correction curves are shown in Fig. 4 for two values of R_k . The curves indicate that more complete compensation for the error in e_H is obtained with $R_k = 560,000$ ohms than with $R_k = 1$ megohm, but better overall circuit results are obtained with $R_k = 1$ megohm. This can be explained by the fact that the nonlinearity introduced by the step in the rundown waveform is not completely compensated for by proper selection of R_c alone. Therefore, the circuit requires an introduction of just the right amount of compensation which would tend to increase the period at low clamping levels and thereby complement the compensation introduced by R_c .

A value of $R_k = 1$ megohm serves to limit the percentage error introduced in the clamping level at high clamping levels, while introducing the proper amount of compensation tending to increase the period at low clamping levels. The initial step in the waveform and the error in the clamping voltage e_H together

with the voltage drop across R_c could introduce errors of as much as 10 percent if care were not taken in selection of R_c , R_k and the clamping potentiometer.

A comparison of linearity measurements made with and without the R_k compensation is shown in Table I. The R_k compensation tends to decrease the maximum error by shifting the zero-error point, splitting the error about that new point. A Helipot Duodial with one dial reading 0 to 10 turns and the other dial a vernier which has a resolution of a hundredth of a turn was used with the helical potentiometer to obtain the readings listed in Tables I and II.

Linearity Measurements

Linearity measurements were made by a method which did not depend upon the absolute accuracy of the equipment used.

An audio oscillator output was connected directly to the vertical input of an oscilloscope and to the horizontal input of the oscilloscope through a 90-deg R-C phase-shifting network, resulting in a circular trace. The positive trigger output obtained from V_c was coupled to the grid of the cathode-ray tube of the oscilloscope through a high-voltage capacitor.

The audio oscillator was set to correspond to the highest frequency of each range of the repetition rate generator shown in Fig. 1. The three plate-coupling capacitors were chosen on a capacitance bridge as exact multiples so that the setting of R_c would establish the 5 to 5,000 pps range. The helical potentiometer was connected so that its maximum value (20,000 ohms or zero turns) corresponded to minimum frequency. In obtaining a 10-to-1 clamping-level ratio with the helical potentiometer, the ninth turn would correspond to the maximum frequency (a setting of 2,000 ohms).

With the audio-oscillator frequency set exactly to the highest frequency of each range of the repetition-rate generator, an intensified dot would become stationary on the circular pattern on the oscilloscope. As the frequency of the repetition-rate generator is varied throughout its range with the audio-oscillator frequency fixed at the highest fre-

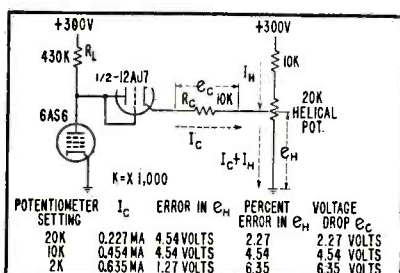

FIG. 3—Section of circuit of Fig. 1 used to introduce nonlinearity compensation

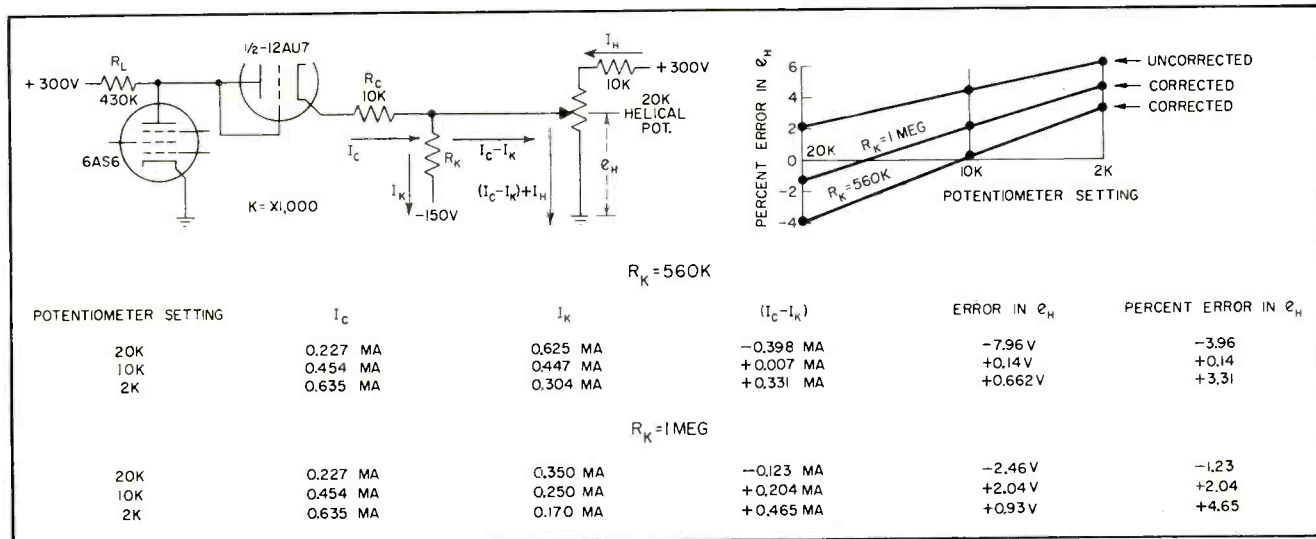

FIG. 4—Equivalent circuit for developing compensation for nonlinearity produced by conduction from B+ through R_L , catching diode and potentiometer to ground. Graph shows error in clamping level due to this source of nonlinearity

quency of that particular range, the frequency of the repetition-rate generator will pass through each submultiple of the audio-oscillator frequency from $f/2$ to $f/10$, and at each one of these points the intensified dot would again become stationary.

The measurements obtained are listed in Table I. A very accurate linearity check can be made without the absolute accuracy of the test equipment entering into the measurement.

This assumes that the audio oscillator will remain stable throughout the measurement. Most oscillators have good short-term stability at these low frequencies. If at a particular setting of the phantastron frequency control, the dot on the circular pattern on the oscilloscope remains stationary over a fairly long period of time, it can be assumed that the oscillator is stable, since it is highly unlikely that the oscillator and the phantastron would drift together.

Additional tracking of the circuit is obtained by setting the audio oscillator to the lowest frequency of each range, so that at each successive multiple of this lowest frequency, an additional intensified dot appears, the pattern becoming stationary at the exact multiple. Listed in Table II are linearity measurements for the two highest frequency ranges. A 5-cps sinusoidal waveform was not avail-

able so that the 5 to 50 pps range could not be checked with this type of measurement.

These two sets of linearity measurements differ primarily in the frequency points that are checked.

Performance

In general, linearity measurements shown in Tables I and II indicate that by using the methods of compensation discussed, the circuit can be made to operate linearly to within 2 percent. Electronically regulated power supplies were used and as a result the long-term stability of the circuit was found to be excellent.

Since frequency is inversely proportional to the period of any waveform, a linear control of period in this circuit results in a dial with a nonlinear frequency calibration. Table II shows that on the 50 to 500 pps range it takes five complete turns to cover the range 50 to 100 pps. The range 200 to 400 pps takes one-and-a-quarter turns while the range from 450 to 500 pps takes only a tenth of a turn. Even at the crowded end of the scale where frequency changes rapidly, 2-percent accuracy is maintained.

Tables I and II show that nowhere is the error greater than one one-hundredth of a turn. A sample calculation shows that if there is an error of one division in the setting within the 450 to 500 pps range, the error would not be greater than 5

pps out of 450 pps, the equivalent of a maximum of 1.1-percent error. Another sample calculation shows that if there is an error of one division in the setting within the 100 to 150 pps range, the error would not be greater than 0.3 pps out of 100 pps which is the equivalent of a 0.3-percent error.

Dial Calibration

A chart can be drawn up to convert frequencies not listed in Table II to the proper dial reading on the helical potentiometer, but a more practical arrangement would be to have a larger calibrated dial geared to the helipot so that this large dial would make one complete revolution for ten turns of the helical potentiometer.

Allowing for possible errors in reading the dial, it is fair to state that a 2-percent accuracy can be maintained using this circuit.

This work was done under the sponsorship of the Rome Air Development Center, Rome, New York, under Air Force Contract AF30-(602)-969 at Browning Laboratories, Incorporated, Winchester, Mass.

The author acknowledges the helpful suggestions contributed by John Collins.

REFERENCE

- (1) "Waveforms", Vol. 19, MIT Rad Lab Series, p 199, McGraw-Hill Book Co., Inc., New York, N. Y., 1949.

UHF Multiplexer Uses

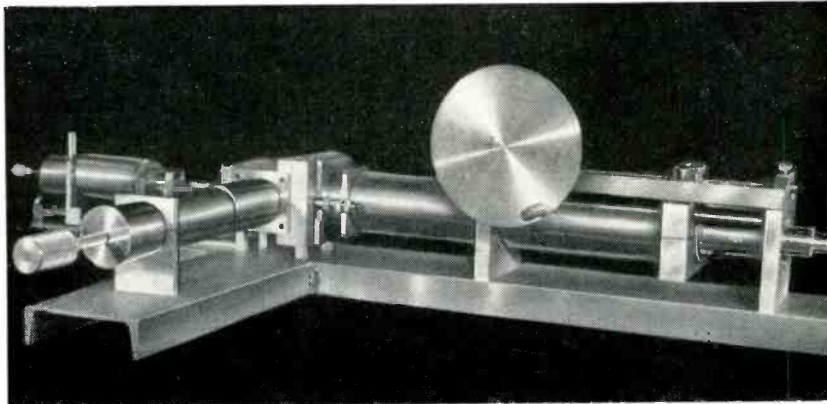

Multicoupler as constructed in coaxial form. Large wheel at right center tunes resonant cavity

SEVERAL transmitters and receivers can be operated on a single antenna in the frequency band from 225 to 400 mc.

The multiplexer designed for this purpose achieves high isolation and low insertion loss at unusually close frequency spacings between transmitters and receivers. When the multicouplers are used with a frequency separation of 3 mc between equipments, the average insertion loss in a 4-coupler system is approximately 1 db per coupler, and the isolation between equipments located at adjacent couplers is approximately 60 db.

Decoupling

Each antenna coupler making up the passive multiplexing system sets up two paths of transmission from a single antenna as shown in Fig. 1. The coupler provides a channel between the antenna *A* and a piece of transmitting or receiving gear located at one of the coupler terminals *T*. Signals not intended for this path are routed from the antenna past the coupler to some other directional coupler¹.

An *n* number of couplers can provide multiplexing of *n* + 1 equipments on a single antenna. The coupler achieves its duplexing action by combining the properties of a directional coupler and a filter permitting simultaneous use of multiplexed signals which are very

By **HERBERT J. CARLIN**

*Research Professor
Microwave Research Institute
Polytechnic Institute of Brooklyn*

closely spaced in frequency.

The design of the coupler is, in first approximation, the coaxial realization of an impedance-bridge equivalent circuit shown in Fig. 2. This bridge is balanced when the product of the impedance in opposite arms are equal. That is $Z_a Z_b = R_c^2 = 1$ or $Z_a = 1/Z_b$.

Impedance Z_a is inverse to Z_b . Under these conditions power at port *T* is entirely decoupled from arm *N*. At the same time port *A* is also decoupled from port *L*. This decoupling is theoretically independent of frequency though parasitic effects in the coaxial coupler prevent the full realization of this frequency invariant performance. The decoupling is related to the directivity of directional couplers and, the actual device is a coaxial directional coupler.¹

The on-resonance insertion loss from a transmitter to an antenna

(*T* to *A*) or the off-resonance loss of a coupler (*A* to *N*) can be made small providing a high enough value of *Q* for the resonant circuits of Fig. 2 is used, and provided that the resonant impedances of these tank circuits are suitably chosen.

Ideally, Z_b should be low at resonance and Z_a high at that point. This permits coupling of *T* to *A* via path *cda*. Off resonance, Z_b must increase rapidly and Z_a decrease so that power from *A* bypasses the coupler and goes to *N* via path *dbc*.

With finite *Q*, the resonance level of Z_b should not be set too low for the impedance level would then never reach high enough values off resonance to produce sufficiently low insertion loss. Similarly, the resonant level of Z_a must not be permitted to be too high at resonance. A further problem is the loss of effective directivity when the coupler is operated with a mismatched antenna. This is taken into account by the use of a variable impedance as a balancing network at arm *L*.

The schematic diagram of the coaxial resonant cavity used to

Table I—Losses in a Four-Coupler System

Frequency	On Resonance insertion loss for single coupler	Average loss per coupler	
		3-mc spacing	5-mc spacing
225 mc	1.5 db	0.68 db	0.61 db
300 mc	0.5 db	0.78 db	0.55 db
400 mc	2.0 db	2.06 db	1.30 db

Selective Couplers

SUMMARY — Frequency selective passive coupler system gives 60-db isolation with an average insertion loss of 1-db per coupler in a 4-coupler multiplexing system having a frequency separation of approximately 1 percent between transmitters

realize the series tank circuit of arm *ab* of the bridge is shown in Fig. 3A. The length *l* is approximately a quarter wavelength at resonance.

Resonant Impedance

Control of the resonant impedance level is achieved by coupling to the circuit at a suitable distance *d* from the open-circuited end of the cavity. The required value of resonant impedance is approximately 50 ohms so that it is necessary to make *d* small by coupling to the region where the electric field is near a maximum so as to get a relatively high resonant impedance level.

An approximate equivalent circuit of the coaxial cavity is shown in Fig. 3B. The resistance *R_o*, which is the resonant impedance, is directly proportional to *l/d* and in-

versely proportional to the cavity *Q*. Thus, the adjustment of distance *d* is equivalent to a variable turns-ratio transformer coupling at resonance.

To cover the frequency band the distance *d* has two positions in the actual coupler, one for the low frequency part of the band and the other for the high end. The impedance variation of the cavity at the coupling point is no longer that of a simple resonant cavity. Neglecting resonances outside the band at the $l = n\lambda/4$ points ($n > 1$), the impedance is shown plotted in Fig. 3C. The series resonant point occurs at $\lambda/4 = l$, corresponding to ω_0 . At a slightly higher frequency ω_1 , the impedance becomes antiresonant. This is desirable since this minimizes the coupling from arm *A* to arm *T* of the coupler and hence reduces the off-resonance insertion

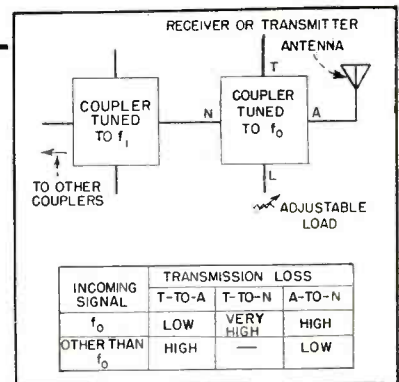

FIG. 1—Table gives impedances presented between various ports of antenna coupler shown in block form

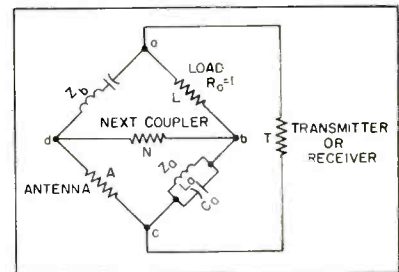
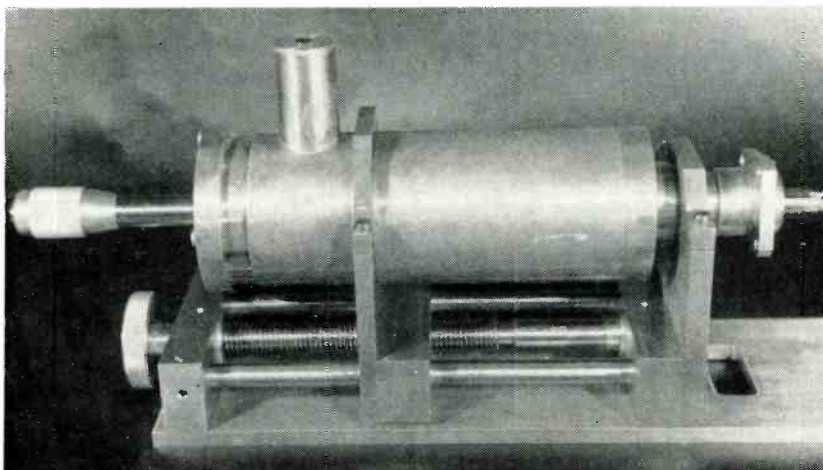

FIG. 2—Equivalent bridge circuits for paths between transmitter or receiver and antenna



Upper knob at left of antenna-matching section adjusts inductance. Lower knob is capacitance control

loss even when close frequency spacing is used. On the low-frequency side of resonance ω_0 , the impedance increases at a slower rate, so that the off-resonance insertion loss is not as small below ω_0 as above.

Above ω_1 , the impedance begins to go down but never reaches a sufficiently low point inside the operating frequency band to adversely affect coupler operation. Even when $f_0 = 235$ mc, the next higher zero of impedance is at 450 mc, 50 mc beyond the highest operating frequency.

The construction of the antiresonant cavity, arm *bc* of Fig. 2 is shown schematically in Fig. 4A. Whereas the resonant arm operates

like a $\frac{1}{2}\lambda$ series-resonant cavity with series coupling at the high-field end, the antiresonant tank is the dual of this. Thus, it is a $\frac{1}{2}\lambda$ parallel-resonant cavity with shunt coupling to the low-field region to achieve relatively low resonant impedance levels on the order of 50 ohms.

The total length of the antiresonant cavity includes the height d of the stub structure $l + d$ shown in Fig. 4A, and adjustment of this dimension is analogous to the action of an autotransformer. The equivalent circuit is shown in Fig. 4B and the admittance plot in Fig. 4C. The low admittance point at antireso-

nance is at ω_0 , and above this point the admittance increases rapidly benefiting the off-resonance insertion loss above ω_0 .

In all respects the operation of this cavity is approximately the dual of the series cavity of Fig. 3. However, it was not found necessary to make the impedance-level adjustable in the actual coupler.

A realization of the coupler in coaxial line is shown in the photograph and in Fig. 5. A bridged-T equivalent obtained by redrawing the bridge circuits of Fig. 2, with the more complex representations of the cavity given in Fig. 3 and

Fig. 4 is also shown in Fig. 5.

The two cavities are tunable for frequencies from 225 to 400 mc, and the impedance-level control which sets the resonant impedance level of the series cavity is also shown.

The series-resonant cavity is located in the inner conductor but is made externally tunable.

Antenna Balancing

The antenna balancing network functions as a variable impedance and is located in arm L of Fig. 2. By adjusting this, it is possible to balance the bridge circuit even when antenna arm A is not matched to R_0 . The balance condition for a null in arm N , $Z_A Z_B = Z_L Z_L$, is achieved by appropriate adjustment of Z_L .

The construction of the balancing network is shown schematically in Fig. 6A. The equivalent circuit of the network is shown in Fig. 6B and its impedance locus in Fig. 6C.

The locus of the parallel R - C circuit is a semi-circle as the capacitor is varied. At any setting of the inductance, adjustment of the inductance moves the impedance along paths typified by the vertical dashed lines. The extent of the impedance plane covered is limited by the minimum and maximum capacitance and inductance in the physical circuit.

The actual design covers all impedances with maximum vswr of 3.0 in 50-ohm coaxial line. The adjustable sleeve C at the back end provides the variable capacitor, and the helical line L , whose turns may be progressively short circuited by the variable coaxial inner conductor gives the variable inductance.

The stub line R is a glass metalized-film resistor capable of handling 10 watts continuously. This is isolated by about 20 db from the transmitter arm by virtue of the coupler characteristics and hence is easily able to operate with a transmitter powered at 100 watts.

The balancing network permits the attainment of high isolation even when the coupler arms are not exactly inverse. That is, it compensates for intrinsic coupler deviations from the ideal bridge circuit as well as for a mismatched antenna. In the photograph of the antenna balancing network, the upper micrometer adjustment controls the

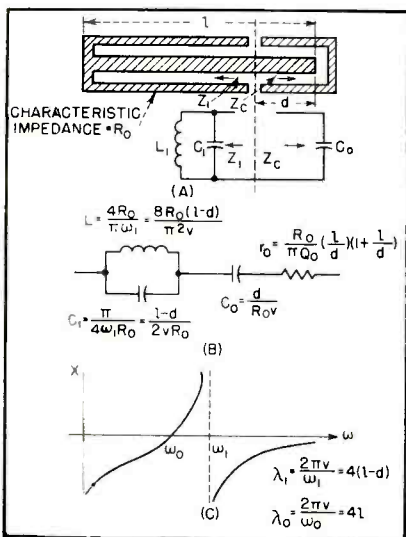

FIG. 3—Basic physical form for resonant leg of bridge (A) with equivalent circuit (B) and reactance-versus-frequency plot (C)

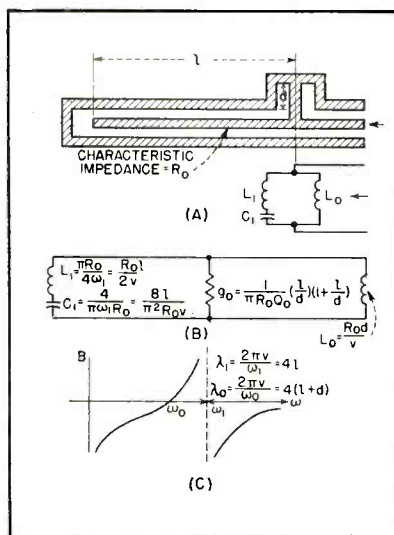

FIG. 4—Physical configuration of antiresonant leg of bridge (A) with equivalent circuit (B) and diagram of susceptance plotted against frequency (C)

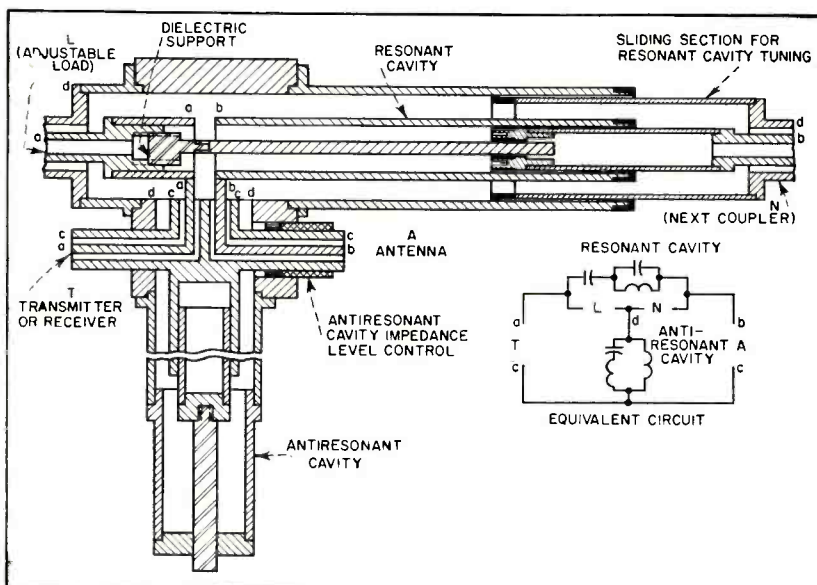

FIG. 5—Cross-section of uhf multicoupler. Letters on diagram refer to points on equivalent circuit

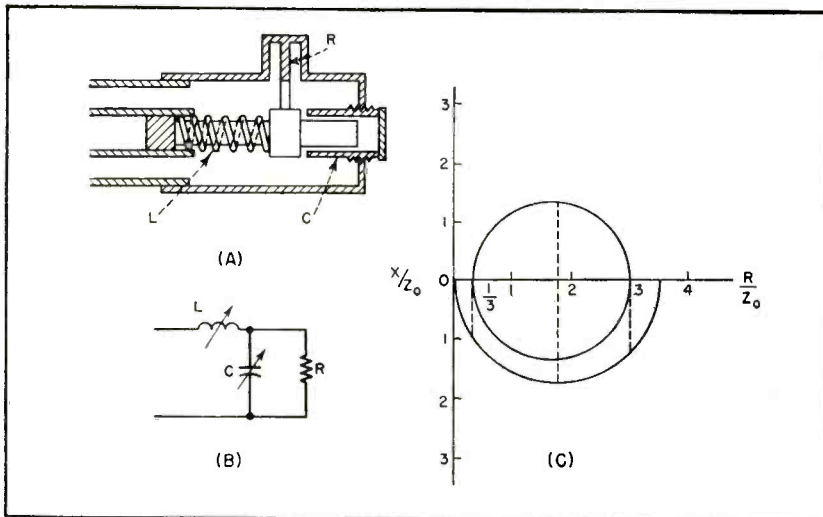

FIG. 6—Antenna balancing network (A) has equivalent circuit shown at (B). Adjustment varies impedance along dashed lines in impedance plot (C)

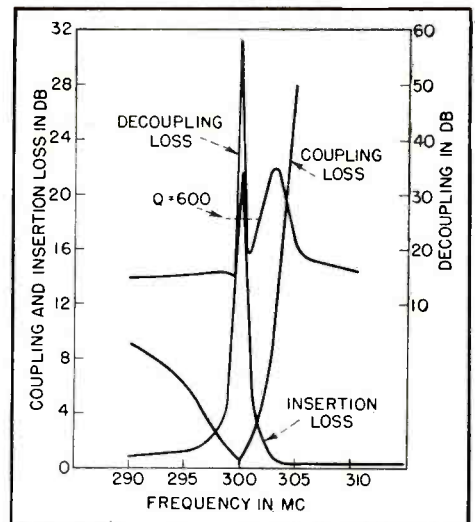

FIG. 7—Measured performance curves for a typical coupler unit

capacitance, and the lower thumb screw moves the coaxial structure in and out to vary the inductance.

Typical performance curves of a coupler tuned at 300 mc and operating with a balancing network are shown in Fig. 7. Insertion loss I is the coupling from A to N (values of I at other than the resonant frequency are the off-resonance insertion losses). The coupling loss is the loss measured from A to T (the resonant value of C is the on-resonance loss), and the decoupling loss is that measured from T to N.

Performance data of a 4-coupler system (a total of 4 equipments—transmitters and/or receivers with a matched load on port N of the last coupler) are given in the table.

Alignment Technique

A typical 3-coupler system is shown in Fig. 8. To operate this system the first transmitting coupler has its cavities set at the desired transmitter frequency f_1 .

A tuning screw permits adjustment of the resonant-impedance level of the resonant cavity. There are only two positions for this adjustment: one for the range of 225-to-320 mc the other for the range 310-to-400 mc. In general, only the frequency tuning of the two cavities need be adjusted for various transmitter frequencies.

The final adjustment of the coupler is made with the antenna balancing network. A tunable detector at the end of the coupler chain is set for the transmitter frequency

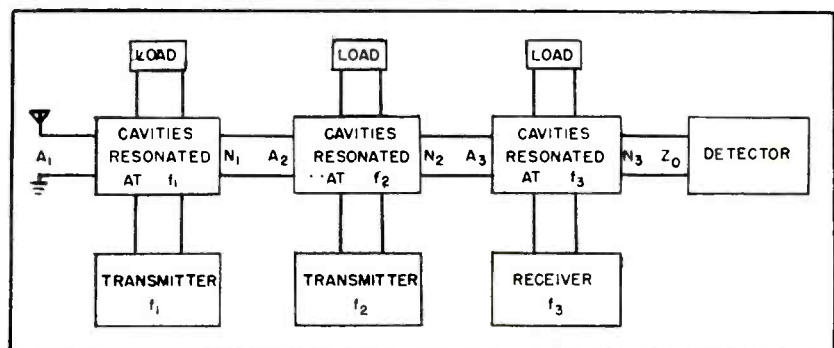

FIG. 8—Arrangement of equipment in three-coupler system. Detector is used for alignment of couplers

and the balancing network is then tuned for a null indication.

The null indicator would first be tuned for f_3 , and then the balancing network of the transmitting coupler set for a null. The detector would then be set for f_2 , and the balancing network of the f_2 coupler (presuming its cavities have already been set at the precalibrated scale indication for f_2) adjusted for a null.

Since the next-coupler port of coupler f_1 has been decoupled from the transmitter port T₁, the adjustment of coupler 2 has no effect whatever on the previously tuned setting of coupler 1.

Freedom from interaction effects between units of the coupler system is almost independent of the closeness of frequency spacing of adjacent equipments. If a uhf receiver of 10-ke bandwidth is used, it can operate even closer than 1 mc to an adjacent high-power transmitter and the residual transmitter

signal will still be low enough in level to be adequately discriminated against by the receiver selectivity.

The main limitation on closeness of frequency spacing is a matter of tolerable insertion losses, and if these are to be of the order of 1-db, then a minimum spacing of about 3 mc is required. If higher losses are permissible (of the order of 3 db per coupler), 1-mc separations are feasible.

The author acknowledges the valuable suggestions of J. W. E. Griemsmann, A. D. Bresler and M. Cohen. The experimental measurements were carried out by P. Paterno and C. Bollinger.

The work described in this article was sponsored by the Rome Air Development Center, U. S. Air Force, under contract No. AF-28(099)-236.

REFERENCE

- (1) H. J. Carlin, A. D. Bresler and M. Cohen, "A New UHF Antenna Multi-coupler System", Report R-397-54, PIB-330, Microwave Research Institute, Polytechnic Institute of Brooklyn, Oct. 1954.

Cathode Compensation

SUMMARY — Increased bandwidth, gain stability and linearity, with lower plate current, are accomplished by compensating cathode circuit. Design of 500-volt output, 3.7-mc amplifier for an oscilloscope is detailed

USE of cathode compensation in a pulse amplifier increases bandwidth and decreases gain by the same factor causing the gain-bandwidth product to remain unaltered.

The same result may be achieved more simply by reducing the value of the plate load resistor. However, cathode compensation improves gain stability, linearity of operation, requires less current for a given output voltage and has other advantages which are given below.

Circuit Theory

To calculate the effect of the cathode impedance on gain and bandwidth the circuit of Fig. 1A is replaced by its equivalent, Fig. 1B. The impedance seen looking toward the tube between plate and ground is equal to $r_p + (1 + \mu) Z_k$ where r_p is the plate resistance and Z_k the impedance in the cathode circuit. If $R_k C_k$ is made equal to $R_L C$, the four elements between points A and B constitute a compensated attenuator. The circuit may therefore be redrawn as in Fig. 1C where

$$e_i' = \frac{\mu e_i [(\mu + 1)R_k + R_L]}{r_p + (\mu + 1)R_k + R_L} \quad (1)$$

$$R' = \frac{r_p [(\mu + 1)R_k + R_L]}{r_p + (\mu + 1)R_k + R_L} \quad (2)$$

and the total capacitance is

$$C' = \frac{R_L C}{[(\mu + 1)R_k + R_L]} \quad (3)$$

The time constant of the circuit is

$$\tau_c = R' C' \cong \frac{R_L C}{(1 + g_m R_k)} \quad (4)$$

if $(R_k + R_L) \ll r_p$. Thus the time constant has been reduced and the bandwidth extended by the factor $1/(1 + g_m R_k)$.

The nominal gain of the amplifier, at a frequency where the capacitors may be neglected, is com-

puted to be $A = -(g_m R_L)/(1 + g_m R_k)$. If the input e_i consists of a unit step of amplitude $-E$ the corresponding output is

$$e_o = \frac{g_m R_L E}{1 + g_m R_k} (1 - e^{-t/\tau_c}) \quad (5)$$

With the cathode connected directly to ground, the output would be

$$e_o = g_m R_L E (1 - e^{-t/\tau_o}) \quad (6)$$

where $\tau_o = R_L C$. In either case the ratio of gain to rise time is the same.

If the screen supply voltage is returned to ground instead of the cathode, the above results are slightly uncertain because the plate current is less than the cathode current, the difference going to the screen, and a signal voltage will appear between screen and cathode. The first of these effects causes the nominal gain to be reduced slightly, but since the compensation depends only on the time constant of the cathode impedance and not its magnitude, the compensation condition remains $R_k C_k = R_L C$.

The signal on the screen grid will be amplified, just as is the control-grid signal, but to a much smaller extent. The screen-grid signal is of opposite polarity to the control-grid signal and as a result the overall gain will be decreased. The cathode impedance will provide the same type of degeneration for the screen-grid signal as for the control-grid signal. It is the cathode time constant that is of importance and hence the cathode compensation condition is unaltered.

Comparative Merits

To show some of the useful features of cathode compensation, two amplifiers, one with and one without cathode compensation will be compared.

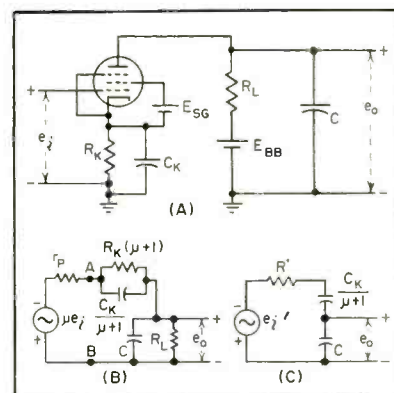

FIG. 1—Cathode compensated amplifier (A) is represented by equivalent circuits (B) and (C)

The first amplifier, without compensation, has a plate resistor R_L and carries a quiescent current I_o . The second amplifier has a plate resistor aR_L and a cathode resistor selected to make $1 + g_m R_k = a$. The quiescent tube current and voltage remain as before, which means plate resistor aR_L must be returned to a higher supply voltage. It may happen that the cathode resistor selected will furnish the bias required for optimum linearity of tube operation. Generally, however, some additional external bias will be required. The capacitance, C , shunting the plate to ground is to be the same in both cases. These two amplifiers now have the same gain and the same bandwidth.

One advantage of the compensated amplifier is its greater stability of nominal gain with respect to variation of tube parameters. In the case where the nominal gain is given by $-g_m (aR_L)/(1 + g_m R_k)$ the gain will be a less sensitive function of g_m than in the case where the gain is given by $-g_m R_L$. In the limiting case in which $g_m R_k \gg 1$, compensated-case gain is $-aR_L/R_k$, independently of g_m .

Linearizes Video Stage

By JACOB MILLMAN and HERBERT TAUB

Electrical Engineering Dept.
Columbia University
New York, N. Y.

Electrical Engineering Dept.
The City College
New York, N. Y.

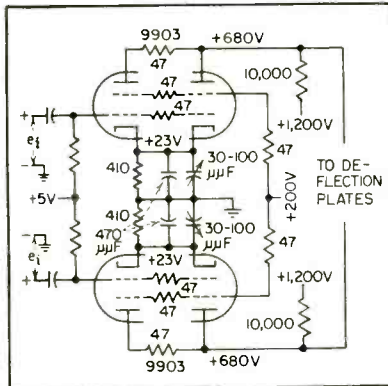

FIG. 2—Detection amplifier for 5-in. crt gives 500-v p-to-p output with current swing of only 25 ma at each tube

A second advantage may be appreciated by considering a problem that arises in the design of the last stage of an amplifier for a cathode-ray oscillograph. Such an amplifier is required not only to meet certain specifications with respect to frequency response, but must additionally be able to provide an undistorted output signal of sufficient amplitude to produce a substantial deflection of the beam.

If the quiescent current of a tube is I_0 , it may be estimated roughly that the tube will operate fairly linearly over a current range $0.25I_0$ to $1.75I_0$, so that the total plate voltage change is $(\Delta I) R_L = 1.5I_0 R_L$. If this output swing is inadequate, it may be increased by increasing the plate resistor, but such a procedure has an adverse effect on frequency response.

One solution to the problem is to change the tube to one whose current can be made large enough to supply the required output voltage across whatever plate resistance must be used to meet the bandwidth specifications. In so doing, the drain of the power supply will have been increased and the additional tube

capacitances of the larger tube may in part undo the advantage gained in not having to increase the plate resistor. In such a case and other similar circumstances where the plate circuit resistor must satisfy certain requirements which are inconsistent with the band-pass or distortion specifications, cathode compensation may be used to advantage.

The compensated amplifier will give a times as much output, for fixed bandwidth, as will the uncompensated amplifier for the same current swing. Because of the way the gain depends on g_m in the two cases and, since g_m is essentially a function of tube current, this larger output signal in the compensated amplifier will have less distortion than the smaller signal available from the uncompensated amplifier. Since the gain of the two amplifiers is the same, the input signal to the compensated circuit must be a times the input to the uncompensated amplifier.

Deflection Amplifier

The amplifier stage of Fig. 2 was used as the deflection amplifier for a 5RP1 cathode-ray tube operating at an overall accelerating voltage of 12 kilovolts. Deflection sensitivity of the cathode-ray tube is about 100 volts per inch and 5 inches of deflection was required.

A first step in relieving the burden on the amplifier is the use of a symmetrical amplifier so that each tube supplies only half the required signal.

Each half of the amplifier uses both sections of the Amperex 9903 dual beam tetrode. The 47-ohm resistors minimize the possibility of high-frequency parasitic oscillations.

The voltage developed across the

cathode resistor is different from the bias required so some additional bias is applied directly at the grids. The total shunt capacitance at each plate load is about $22 \mu\text{f}$. For the value of $R_k = 410$ ohms, the value of C_k needed is $535 \mu\text{f}$.

The quiescent cathode current is about 56 ma and the quiescent plate current is 52 ma. At these currents the g_m of both sections together of the 9903 is about 10 millimhos. The gain, calculated from $|A| = g_m R_L / (1 + g_m R_k)$, is 19.6, while the 3-db frequency is 3.7 mc.

The 250-volt output signal required at each plate is achieved with a plate current change of only 25 ma. The required input swing is about 13 volts and the factor $(1 + g_m R_k)$ is about 5.

If cathode compensation were not employed the plate resistor would have to be reduced to about 2,000 ohms and for comparable linearity of output, a tube would have to be selected which could furnish a quiescent current of about 250 ma.

Another application for cathode compensation exists in connection with direct-coupled amplifiers. If a plate load is used that is small enough to give good high-frequency response then the d-c voltage drop across this load may be so small that a rather high voltage exists at the plate. Hence, a direct connection from this plate to the grid of a succeeding tube may be inconvenient. This d-c plate voltage may be reduced and a direct connection possibly used if the plate load is increased. The frequency response may be restored through cathode compensation.

The authors wish to express their appreciation to M. Star and J. Rabinowitz of the Tel-Instrument Co. for their contributions to development of the circuit of Fig. 2.

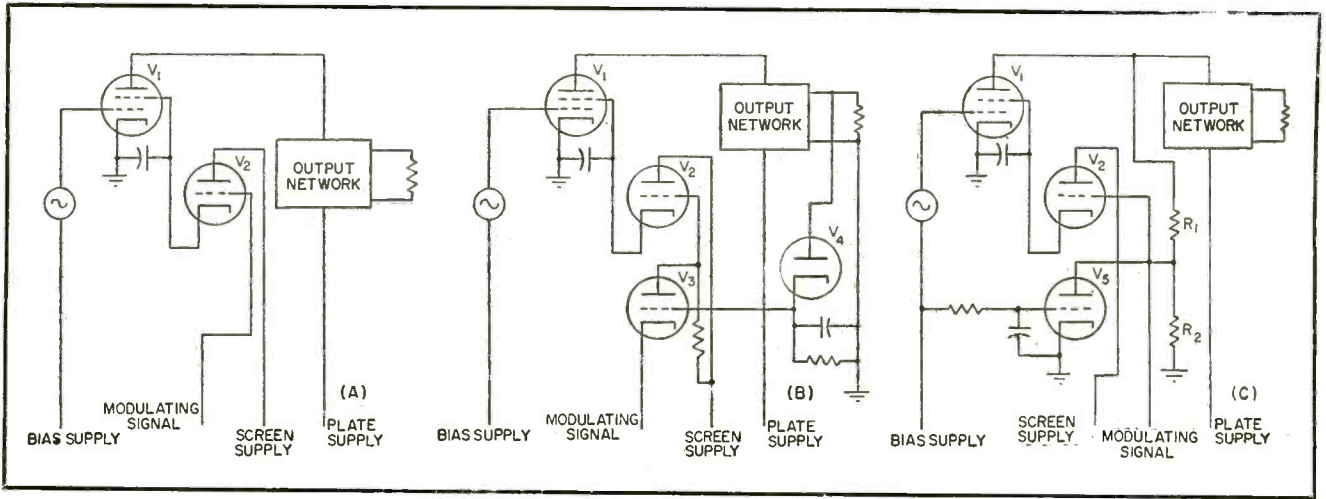

FIG. 1—Elements of series-tube system (A) with feedback rectifier (B) and tube protection (C)

Series Tube Modulates

SUMMARY — Low-level system can be employed for any service requiring high information rate, light weight, simplicity of adjustment, easy variation of output power or controlled-carrier operation

ADVANTAGES and disadvantages of the various methods of high-level and low-level amplitude modulation of radio-frequency transmitters are generally known to radio engineers.

In addition to better known and more conventional methods it is possible to modulate the output of a transmitter by inserting a tube in series with the screen supply of the modulated amplifier.

System Advantages

Such a system has several advantages over most other low-level systems. Since even high-power screen-grid transmitting tubes operate with relatively low screen-grid voltages and currents, this series tube may in many cases be a receiving-type tube.

Frequency of the modulating signal may be allowed to vary from d-c to a very high frequency since the output of the modulator is derived from the cathode of the series tube, which has a low-output impedance like a cathode follower. The modulating system operates at relatively high efficiency.

By **W. B. BERNARD**

*Commander, U. S. Navy
U. S. Navy Electronics Lab.
San Diego, California*

Inverse feedback can be applied easily over a wide frequency range. The transmitter is easy to adjust. In the simpler version, power output can be adjusted with a single control without disturbing loading or modulation adjustments.

Since the modulation system is

directly coupled it is possible to operate under controlled-carrier conditions without complicated circuits; it is only necessary to form the modulating voltage so the screen-grid voltage is zero during periods of no modulation.

Figure 1A shows the most elementary form of the series-tube screen-grid modulation system. The r-f amplifier V_1 is adjusted like a c-w amplifier with maximum rated

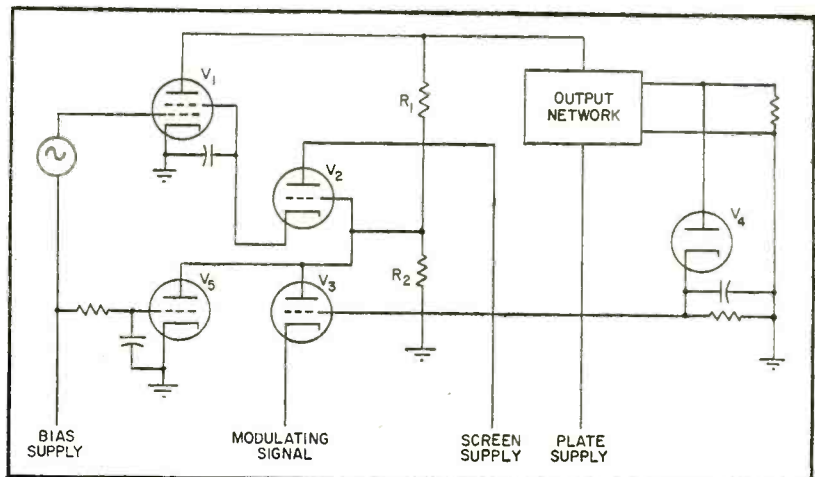

FIG. 2—Intermediate stage in development of practical circuit

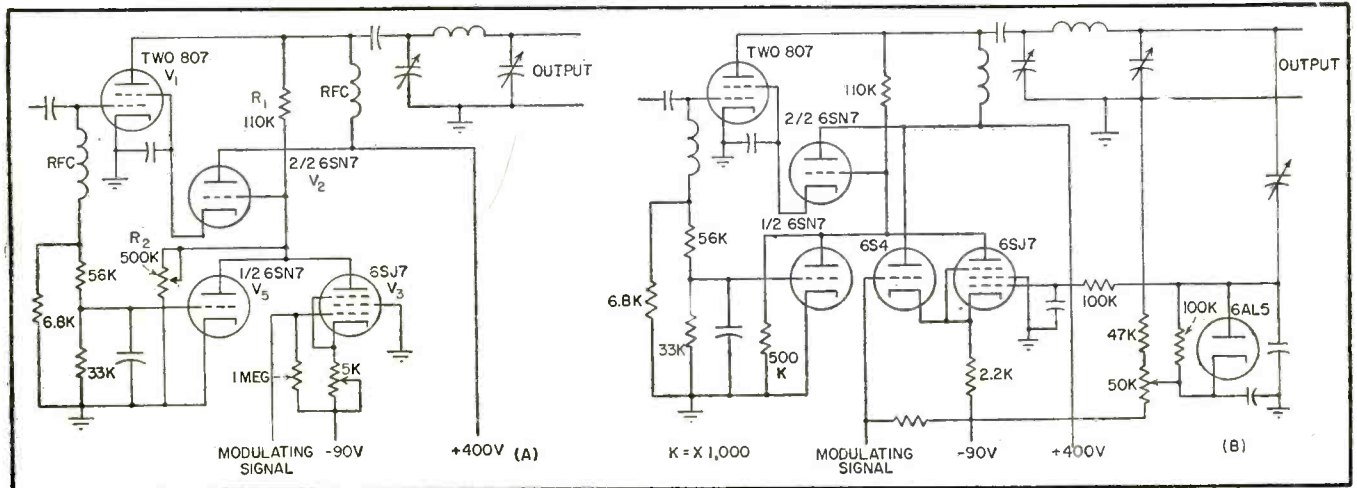

FIG. 3—Version of final circuit (A) with inverse feedback added (B)

Amplifier Screen-Grid

screen voltage. After this adjustment the output power of the stage may be varied from zero to maximum by varying the potential on the grid of V_2 . Because of the mode of operation, V_1 may be operated continuously at any output level from zero to maximum without exceeding its ratings. Such operation permits maximum flexibility in the use of the transmitter.

Certain screen-grid transmitting tubes have a nonlinear relation between screen-grid voltage and power output. Such nonlinearity and any nonlinearity contributed by other parts of the system can be reduced by rectifying a portion of the transmitter output and applying this rectified signal as inverse feedback. Figure 1B shows the basic circuit with the feedback rectifier V_4 and an amplifier V_3 added.

Tube V_3 is used to amplify the feedback signal and also to permit the application of the feedback and modulating-signal voltages to separate tube electrodes. It should be noted that the whole system is still directly coupled. Controlled-carrier operation is therefore still possible and the inverse feedback will stabilize the power output of V_1 as well as contribute to the linearity of the modulation process.

Figures 1C and 2 show the addition of the tube protection feature to the circuits of Fig. 1. Resistors

R_1 and R_2 are selected such that the potential at their junction is slightly below the desired maximum operating screen-grid voltage of V_1 . In most cases R_1 can be selected high enough in value to prevent excessive dissipation from applied r-f power.

Should this prove impossible a radio-frequency choke can be connected in series with R_1 to remove the r-f voltage from it. Resistor R_1 could be connected to a point below the output network. However, this would not protect V_1 against damage in case some component within the network open-circuited. Under normal operation the grid-bias supply to V_1 cuts off the plate current of V_6 so that it has no effect on the operation of the circuit.

Safety Feature

If grid bias is lost, V_6 conducts and brings the grid of V_2 to a low potential. The cathode of V_2 follows the grid to a relatively low potential thus greatly reducing the screen voltage of the tube. Sampling of the bias voltage should properly be done at the grid of V_1 , if fixed bias is used, to guard against damage resulting from an open circuit in the grid network. With grid-leak bias any difficulty in the input circuit will remove the bias from the grid of V_5 , which will provide the necessary protection.

Failure of the plate-supply volt-

age or an open circuit in the d-c portions of the output network will cause the voltage at the junction of R_1 and R_2 to fall to zero, thus bringing the grid of V_2 to zero potential. The potential at the cathode of V_2 and the screen of V_1 will be reduced to low value, preventing damage to V_1 . In the circuit shown in Fig. 1C the output power of the transmitter may be varied by making R_2 variable.

For a practical check on design factors a transmitter was constructed and tests conducted. The transmitter was first wired as shown in Fig. 3A. A 6SJ7 pentode was chosen as V_3 to realize a large stage gain. It was necessary to return the cathode of V_3 to -90 v to bring the cathode voltage of V_1 down to zero potential. The transmitter was set up with V_3 disconnected from the circuit.

The screen-grid voltage of V_1 was set to 250 volts by adjusting R_2 , then V_3 was connected and the 6SJ7 cathode resistor was varied until the screen voltage of V_1 was reduced to 125 volts. Oscillograms in Fig. 4 were taken with these settings. Figure 4A is a trapezoidal pattern showing the modulation characteristics of the transmitter under normal modulation.

Operating conditions were such that at the most negative modulation point the carrier was not com-

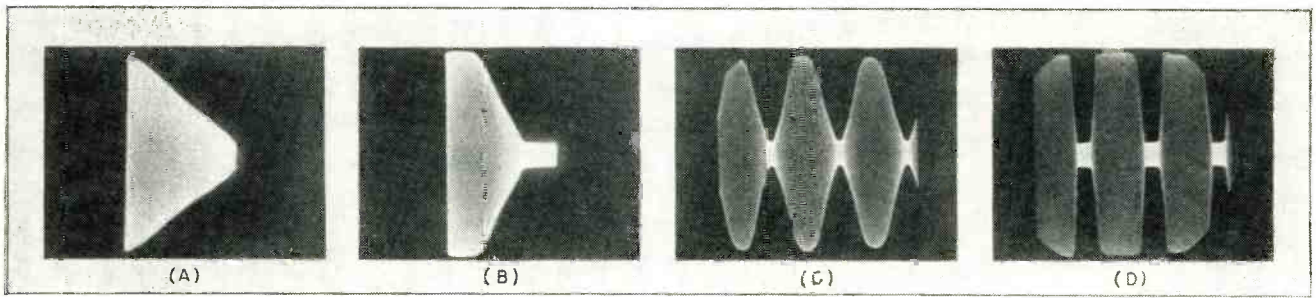

FIG. 4—Oscillograms taken from early version of final circuit are described in text

pletely cut off. Figure 4B is a trapezoidal pattern showing the effects of heavy overmodulation. The transmitter saturates smoothly at the maximum positive peaks and does not go to zero output at the negative peaks. This oscillogram shows that a transmitter using this modulation system may be overmodulated without the splatter caused by abruptly cut carrier.

If desired, a change in operating voltages and better shielding would permit the carrier to be reduced more nearly to zero output at negative modulation peaks. Envelope oscillograms Fig. 4C and 4D correspond to (A) and (B) respectively, Fig. 4C being a normally modulated envelope and that at (D) being a

heavily overmodulated envelope.

With the transmitter normally modulated as shown by Fig. 4C, the value of R_s , in Fig. 3A, was reduced to reduce the output power of the transmitter. Since R_s is also a part of the plate load of V_s , a reduction of its value reduces the gain of V_s .

This results in an automatic reduction in the level of the modulating signal along with the reduction of the output power. Figure 5A is in an envelope oscillogram showing the effect of reducing R_s . No other controls were adjusted between the taking of oscillograms Fig. 4C and Fig. 5A.

In Fig. 3B inverse feedback is added to the transmitter. Output of the carrier rectifier is returned

to the grid of the 6SJ7 and the modulating signal introduced into the cathode of the 6SJ7 by a 6S4 cathode follower. Cathode of the 6SJ7 is returned to -90 volts.

Using this circuit connection the amount of gain reduction caused by inverse feedback is controlled by the capacitor that couples the 6AL5 diode to the output circuit. Once a satisfactory amount of gain reduction is set, the proper carrier operating point can be established by adjusting 6AL5 cathode voltage.

Modulation Patterns

Trapezoidal patterns show normal modulation, Fig. 5B and considerable overmodulation, Fig. 5C. These are similar to Fig. 4A and 4B except that the modulation characteristic is somewhat more linear as might be expected from the use of inverse feedback. Figure 5D is an envelope pattern showing the transmitter set with the quiescent carrier at the maximum output level with negative pulses modulated upon the carrier. Figure 5E shows the quiescent carrier set for minimum level with positive pulses modulated upon the carrier. These oscillograms indicate the great flexibility and utility of series-tube screen-grid modulation.

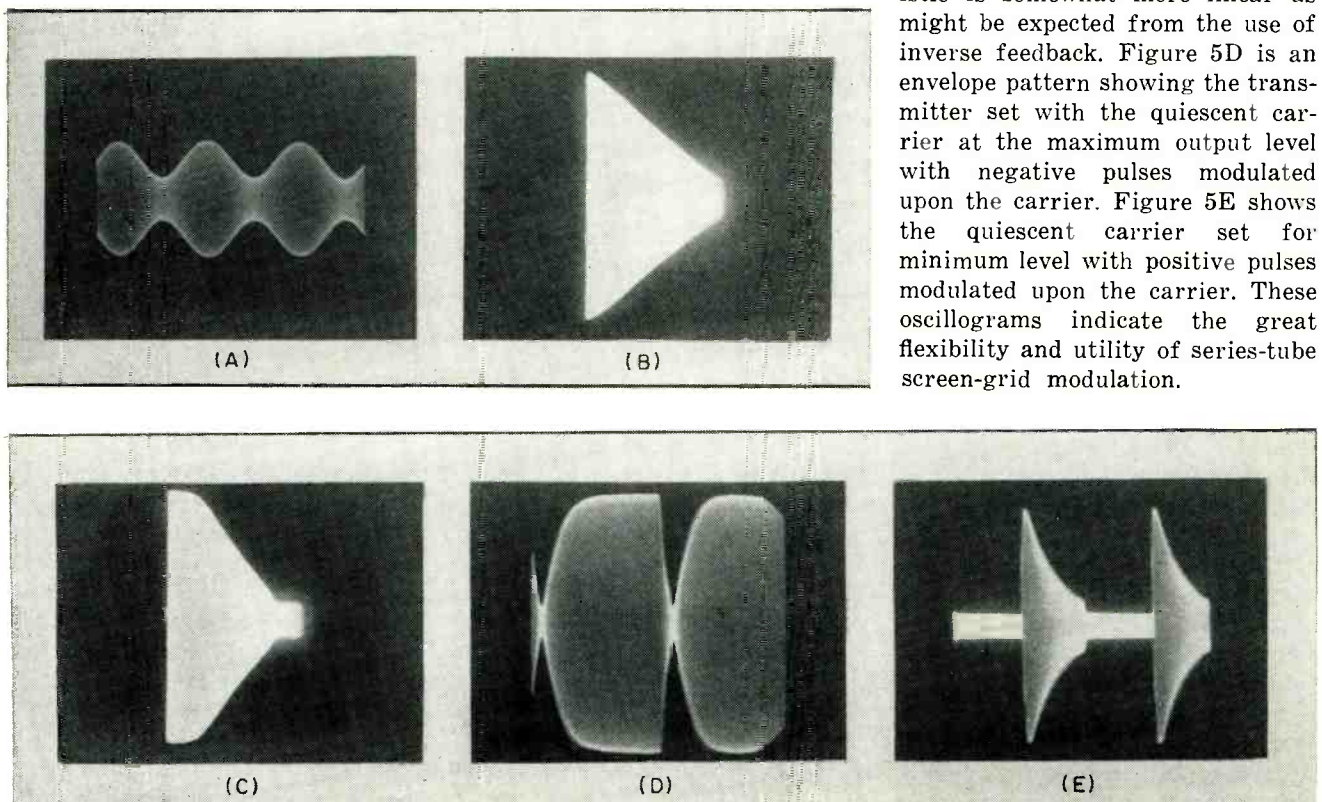

FIG. 5—Power reduction automatically reduces modulation (A). Other waveforms show versatility of modulation system

Direct-Reading Noise-Figure Indicator

SUMMARY — Useful in evaluating performance of traveling-wave tubes and other microwave components, instrument has a linear output on a decibel scale. Absolute accuracy is better than ± 0.3 db. Relative accuracy, when used as a null-reading device, is better than ± 0.1 db

AN IMPORTANT aspect of the evaluation of microwave components and systems is the measurement of noise figure.

Conventional measurement techniques become tedious when there is a large number of parameters to be varied, and it would therefore be desirable to have an instrument capable of reading noise figure directly and with a minimum of adjustments.

Such a device has been constructed and has proved valuable in evaluating the performance of a number of RCA type 1038 low-noise traveling-wave amplifiers.

Various devices of a similar nature have been constructed in the past.¹ All of these employ some sort of gas-discharge device such as an ordinary fluorescent tube as a standard noise source. This noise source is square-wave modulated at a frequency of the order of 30-80 cps and the resultant modulated noise-signal fed into the input of the device to be studied. The ratio of this modulated component of noise to the unmodulated component may be used to determine the noise figure.

In particular, if all amplifiers are linear and a quadratic detector is used, the output voltage is proportional to the noise power and the noise figure is equal to the noise-source power minus the ratio of the modulated to unmodulated output voltages in db.

The present noise indicator dif-

By **G. E. CHASE**

*Lincoln Laboratory
Massachusetts Institute of Technology
Lexington, Massachusetts*



Front panel of noise indicator

fers from earlier designs chiefly in the use of simple circuits to take the logarithms of these two voltages and subtract them giving an output which is linear on a db scale. The output meter has a scale covering a range of ± 3 db about a zero which may be set at any value by varying the r-f power from the noise source and may be read reproducibly within ± 0.1 db.

Principles of Operation

The noise figure F of a receiver may be defined as²

$$F = P_n / 4KT_o R_a df$$

where P_n is the total noise power of the receiver referred to the input, K is Boltzmann's constant, $T_o = 290$ K, R_a is the resistance of a matched load or dummy antenna at the input to the amplifier and df is the effective

amplifier bandwidth. If the amplifier input is connected first to a matched load at room temperature and then to a noise source which may be considered as a matched load at some elevated temperature T_2 , F may be defined by

$$F = [(T_2/290) - 1] / (Y - 1)$$

where Y is the ratio of the noise powers at the output of the amplifier under these two conditions.

Consider a noise source at a temperature T_2 and define the excess noise n in db by $n = 10 \log [(T_2/290) - 1]$. If P_1 is the noise power at the output terminals of the amplifier when its input is connected to a matched load at room temperature and P_2 is the increase in output noise power when the input is connected to the noise source, the noise figure in db is given by

$$F(\text{db}) = n - 10 \log P_2/P_1$$

A device which has an output proportional to $\log P_2/P_1$ reads noise figure directly in db, apart from the constant term n which may be set at any desired value either by varying the noise ratio of the noise source in the case of a hot load or saturated noise diode or by inserting a known amount of r-f attenuation between the noise source and the amplifier in the case of a fluorescent-tube noise source.

Description of Noise Meter

The complete apparatus for direct noise measurement of an r-f ampli-

fier is shown in Fig. 1. The noise source, a Kay Microwave Mega-Node type RG48/U, is modulated with a 60-cps square wave. The far end is terminated in a matched load. A calibrated r-f attenuator makes it possible to set the noise power from the noise tube at any desired value below its full output of 15.84 db excess noise.³ This modulated noise signal is fed into the input of the amplifier being tested, then through a balanced mixer, 30-mc i-f amplifier and into the direct-reading noise indicator.

A complete circuit diagram of the noise indicator is shown in Fig. 2. The first tube is a 404A i-f amplifier designed to extend the linear range of i-f amplification so that a bolometer detector may be used. The bolometer bridge consists of two 5-milliamperes Littelfuses and has a square-law characteristic up to about 100 millivolts output. The time constant of the detector is chosen to pass the 60-cycle modulation with little distortion while removing most of the higher-frequency noise components. The d-c amplifier has a gain of about 500 and is linear up to about 50 volts.

Circuit Details

The output waveform of the d-c amplifier is shown at the bottom of

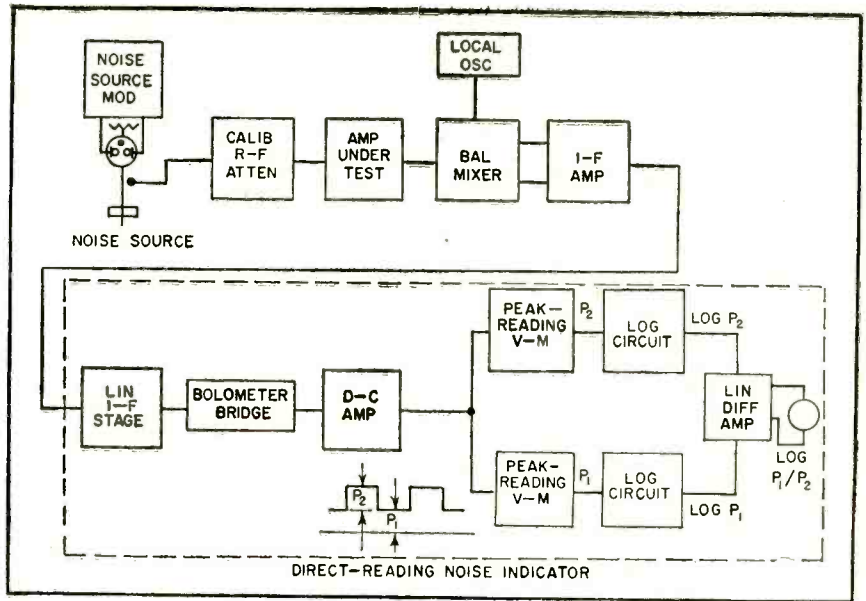

FIG. 1—Test setup for noise-figure measurement. Dashed lines enclose direct-reading noise indicator

Fig. 1. Level P_1 is proportional to the noise power at the output of the amplifier under test when its input is terminated in a matched load. Level P_2 is similarly proportional to the increase in this noise power when the noise source is turned on. The two peak-reading voltmeters develop d-c output voltages equal to P_1 and P_2 with an error no greater than 5 percent over the operating range of the instrument, which corresponds to a range

of 5 to 20 volts out of each peak-reading voltmeter.

These voltages are applied to two logarithmic circuits consisting of R_2-D_1 and R_3-D_2 . Diodes D_1 and D_2 are type 6S5K84 selenium rectifiers, which obey a logarithmic current-voltage relationship for small currents.⁴ The voltages appearing at the grids of the differential amplifier V_6 are thus proportional to $\log P_1$ and $\log P_2$.

A 100- μ amp zero-center meter M_1

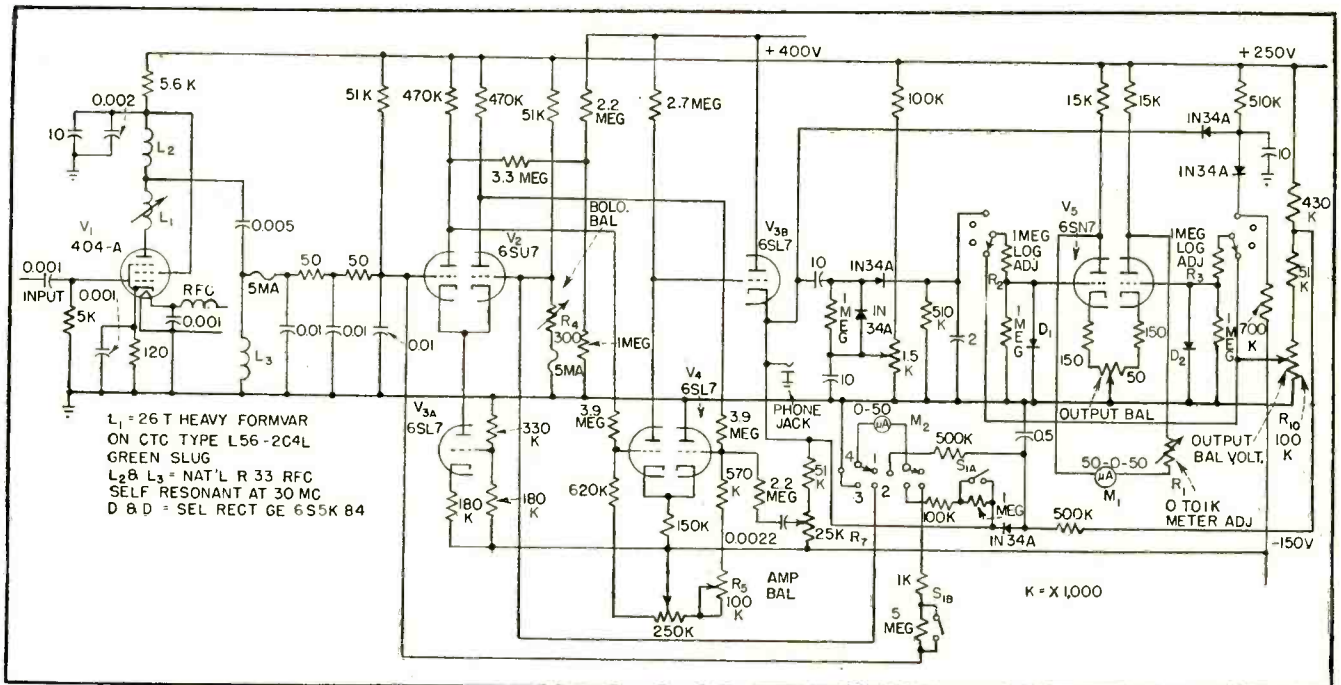

FIG. 2—Bolometer bridge, dual peak-reading voltmeters and logarithmic circuits combine to provide linear output reading on decibel scale

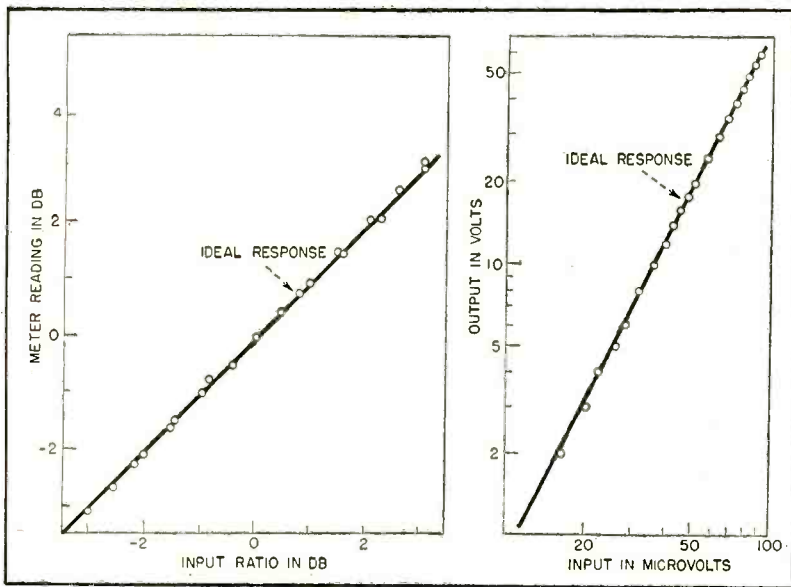

FIG. 3—Response of logarithmic circuits, left, and of amplifiers and detector, right. Solid lines show ideal response

connected between the anodes of V_6 reads a quantity proportional to $\log P_2/P_1$. Resistor R_1 may be adjusted to calibrate this meter over a convenient range. The present instrument has a range of ± 3 db.

The four-position rotary switch together with the 0-50- μ amp meter M_3 permits easy balancing of the bolometer bridge, d-c amplifier and output tube. After the first half hour of operation only occasional readjustment is necessary. With the switch in the operate (4) position M_2 reads voltage P_1 . This must be set in the range 5-20 volts by adjustment of the i-f gain.

Potentiometer R_{10} allows a variable d-c voltage to be applied simultaneously to the two logarithmic circuits when the rotary switch is in position 1 (balance output). When R_2 and R_3 are adjusted to compensate for the slight differences in the characteristics of D_1 and D_2 , the output meter should read 0 ± 0.1 db when this voltage is varied from 5 to 20 volts. After the initial adjustment of R_2 and R_3 , this voltage is left in the neighborhood of 10 volts and is applied to the two logarithmic circuits when the output is being balanced.

Potentiometer R_7 provides an adjustable amount of positive feedback through the 0.0022- μ f capacitor to V_4 . This gives the d-c amplifier an increased high-frequency response to compensate for the relatively poor frequency re-

sponse of the bolometer detector. Since the characteristics of Littelfuses vary widely the output waveform at the cathode of V_{8B} should be observed on an oscilloscope whenever bolometers are changed and R_7 should be adjusted until the top and bottom of the square wave appear flat and the base line does not move when the noise source is switched on and off. A phone jack is provided for this purpose. This adjustment will make the absolute value of noise figure accurate within ± 0.3 db. For more accurate results R_7 should be adjusted by direct calibration against a device of known noise figure, since this is a somewhat more critical test than observation of the waveform.

Potentiometers R_4 and R_6 are front-panel controls. Pushbutton S_1 increases the sensitivity of M_2 during the balancing operations. This is necessary to prevent damage to the meter under initial conditions of extreme unbalance or should a bolometer burn out.

Performance

The logarithmic circuits and differential amplifier were tested by applying a fixed d-c voltage of 10 volts to one logarithmic circuit and a variable voltage of 5 to 20 volts to the other, corresponding to a range of ± 3 db at the input to the instrument. This was done with first one logarithmic element and then the other held constant so that both

could be checked over the operating range. The results are shown in Fig. 3, left. The errors are within 0.1 db over the entire range.

The linearity of the amplifiers and power law of the detector were determined by feeding a 30-mc signal into the input of the i-f amplifier and measuring the output of the d-c amplifier at the cathode of V_{8B} as a function of input signal voltage. The results are shown in Fig. 3, right, where d-c output voltage in volts is plotted against input voltage. It can be seen that the output voltage is accurately proportional to the input power up to at least 60 volts output. The characteristic is independent of the gain of the i-f amplifier and holds equally well for each of several different bolometers which were tried.

The performance of the peak-reading voltmeters was tested by applying a 60-cycle square wave of variable amplitude superimposed upon a variable d-c voltage. The errors were less than 1 percent at 10 volts input and not over 5 percent at the limits of the range of operation, 5 and 20 volts.

The absolute value of noise figure is accurate to ± 0.3 db, or somewhat better if a direct calibration is made against a standard noise-measuring apparatus. If the instrument is used as a null-reading device by varying the r-f attenuator until the output meter reads zero, measured differences in noise figure are accurate and reproducible within ± 0.1 db. When the r-f attenuator is fixed and the noise figure read from the output meter, errors in relative values do not exceed ± 0.2 db.

The author expresses appreciation to L. D. Smullin for his encouragement of this work and for many helpful suggestions and to E. Maxwell for many useful discussions and assistance.

The work described in this article was supported jointly by the Army, Navy and Air Force under contract with the Massachusetts Institute of Technology.

REFERENCES

- (1) R. W. Peter, *RCA Rev*, 12, p 269, 1951.
- (2) A. van der Ziel, "Noise", Prentice-Hall, New York, 1954.
- (3) W. W. Mumford, *BSTJ*, 28, p 608, 1949.
- (4) N. M. Schaeffer and G. W. Wood, *Proc IRE*, 42, p 1,113, 1954.

Low-Ripple Adjustable

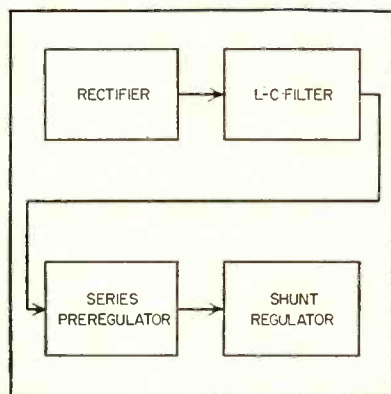

FIG. 1—Complete power supply

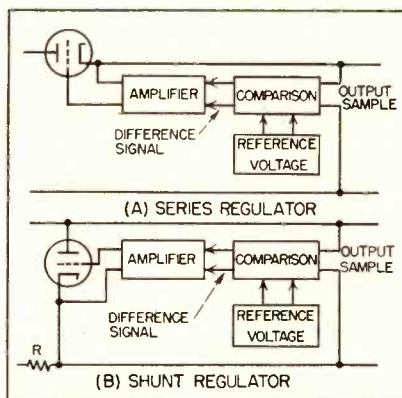

FIG. 2—Basic regulator circuits

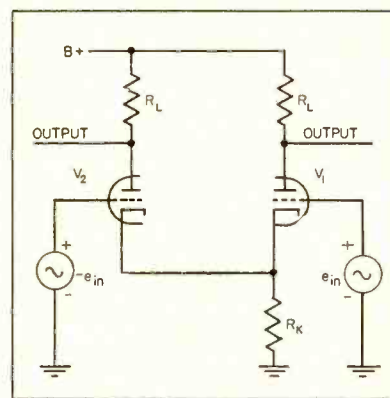

FIG. 3—Basic balance amplifier

AN ELECTRONIC power supply meeting ripple requirements for critical circuits consists of a rectifier, filter and two-stage regulator, as in Fig. 1. At 1,000 v output, there is less than 20 μ v peak of random signal and no discernible ripple. The output voltage can be set to any value between 350 and 1,000 v, and output impedance is 10 ohms or less.

Degenerative voltage regulators can use either a series regulator tube or a shunt regulator tube, as shown in Fig. 2. Basically, however, the operation is the same: The output is compared with a reference voltage, usually a battery or a v-r tube, and the amplified difference signal is applied to the regulator tube in such a way as to reduce the difference signal. In the series regulator of Fig. 2A, this is accomplished by changing the plate voltage drop of the series or gate tube; in the shunt regulator of Fig. 2B, it is accomplished by changing the current drawn by the regulator tube. This current, in addition to the load current, flows through R and any power supply impedance.

A regulator of either type using two twin triodes as amplifiers can easily be built to give a ripple reduction of 1,000. When such a regulator is used to regulate the output of a moderately good rectifier-filter system with ripple output

in the order of a few volts, it provides an output ripple in the order of a few millivolts.

The effect of transformer magnetic fields has been made negligibly small by the use of only one ground point in the regulator chassis so as to eliminate possible loops, and by removal of transformers from the regulator chassis. Transformers placed in the vicinity of the preregulator amplifier tube cause ripple in the output, which apparently results from a modulation of the tube electron beam by the transformer field.

Rectifier voltages to ground are caused by coupling from all parts of the rectifier circuit to ground and to the power transformer primary. Commonly these voltages are in the order of tens of millivolts, acting on impedances in the order of megohms. This condition can give rise to a large amount of output ripple if the proper choice of series or shunt regulator is not made.

Regulator output ripple can be reduced to an acceptable amplitude by selecting the preregulator and regulator so that one terminal of the rectifier is grounded. For positive output terminal grounded, one terminal of the rectifier can be grounded by using a shunt preregulator and a shunt regulator.

Similarly, the series preregulator

and series regulator are effective when the negative output terminal must be grounded.

In practice, for positive output terminal grounded the series preregulator and shunt regulator are nearly as effective as the shunt system. Similarly, for negative output terminal grounded, a shunt preregulator followed by a series regulator would be satisfactory.

Amplifier

The balanced amplifier shown in Fig. 3 is employed throughout the preregulator and regulator. It is quite suitable for such applications because gain is not seriously reduced no matter how large the cathode resistance R_k may be, and the sum of the currents through the two triodes is nearly constant.

Freedom from gain dependence on R_k is desirable because it allows use of as large a cathode resistance as may be required to adjust tube operating voltages. With other circuits there is serious loss of gain because the cathode resistance cannot be bypassed at zero and very low frequencies.

The foregoing considerations make the problem of supplying plate voltages to the required high-gain d-c amplifier relatively simple. The gain of each half of the circuit is exactly the gain that each half would have with a perfectly

Regulated Power Supply

SUMMARY — Two stages of degenerative regulation reduce power supply ripple to a fraction of a millivolt while giving relatively low output impedance as required for critical electronic equipment. Output is adjustable over range of 350 to 1,000 volts

By **GEORGE HETLAND, JR.** and **ROBERT R. BUSS**

*Applied Electronics Laboratory
Stanford University
Stanford, Calif.*

bypassed cathode resistor connected from cathode to B minus.

In some cases the grid of V_2 must be operated with no input signal. An example of such operation is the circuit of V_1 in Fig. 4. Since operation with one grid grounded halves the input signal, the output signal is also halved, assuming that the cathode resistor is moderately large.

Operation

The complete circuit is shown in Fig. 4. In the shunt regulator, V_4 acts as a constant-current tube;

V_5 in the preregulator serves a similar function. Since in the regulator the current drawn by V_1 and V_2 is almost constant, there is a fairly constant 300-v plate supply which appears between the cathode of V_4 and the negative output lead. The plate-cathode voltage of V_4 changes with changes in output voltage caused by output control R_1 or the fine output adjustment R_2 . With 1,000 v output, the plate-cathode voltage of V_4 is 700 v, which somewhat exceeds the voltage rating but not the power rating. From the standpoint of tube life,

a high-voltage tube would have been preferable, but minimum tube drop would have been greater, making it difficult to regulate output down to 350 v.

The removal of C_1 and, in the preregulator, C_2 , will allow oscillations around the high-gain amplifier loop. Since it is desirable to have an output capacitor, this method of preventing oscillations was chosen.

In operation R_1 and R_2 are adjusted to give 5 ma through V_5 with the given load and desired output, and the rectifier voltage is then adjusted to give 250 v drop across gate tube V_7 . In use, the system has been operated at fixed voltages for long periods of time and this adjustment procedure, when necessary, has not been found to be burdensome. If a great many changes in output voltage setting were contemplated, it would be possible to gang these controls.

An output current limitation is set on the system by the 12.5-watt allowable plate dissipation of V_7 . Thus a maximum of 50 ma may safely be passed with 250 gate voltage, leaving about 35 ma for the load.

The work reported in this paper was supported by a joint Army-Navy-Air Force contract held by the Electronics Research Laboratory, Stanford University.

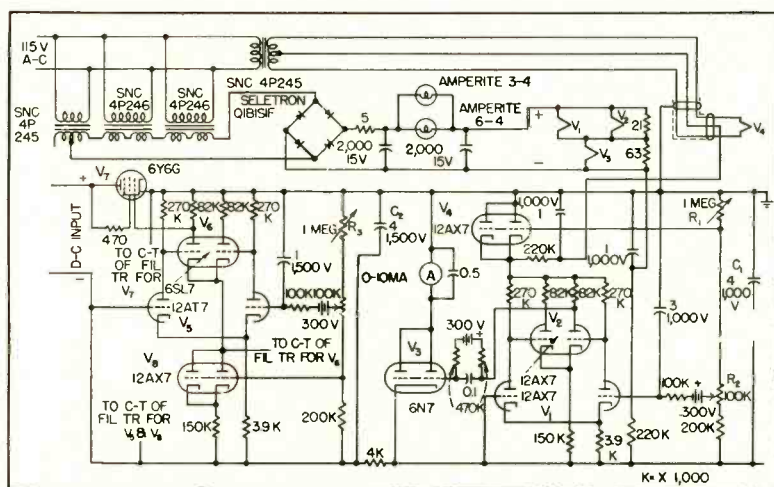

FIG. 4—Complete circuit of preregulator, regulator and d-c filament supply. Adjust rectifier input for hot spot on regulator tubes. The 12AX7 was selected as first amplifier tube in regulator because of its comparatively low noise output. Dry-cell batteries serve as voltage references. Use of d-c heater supply eliminates 60-cps signal modulation

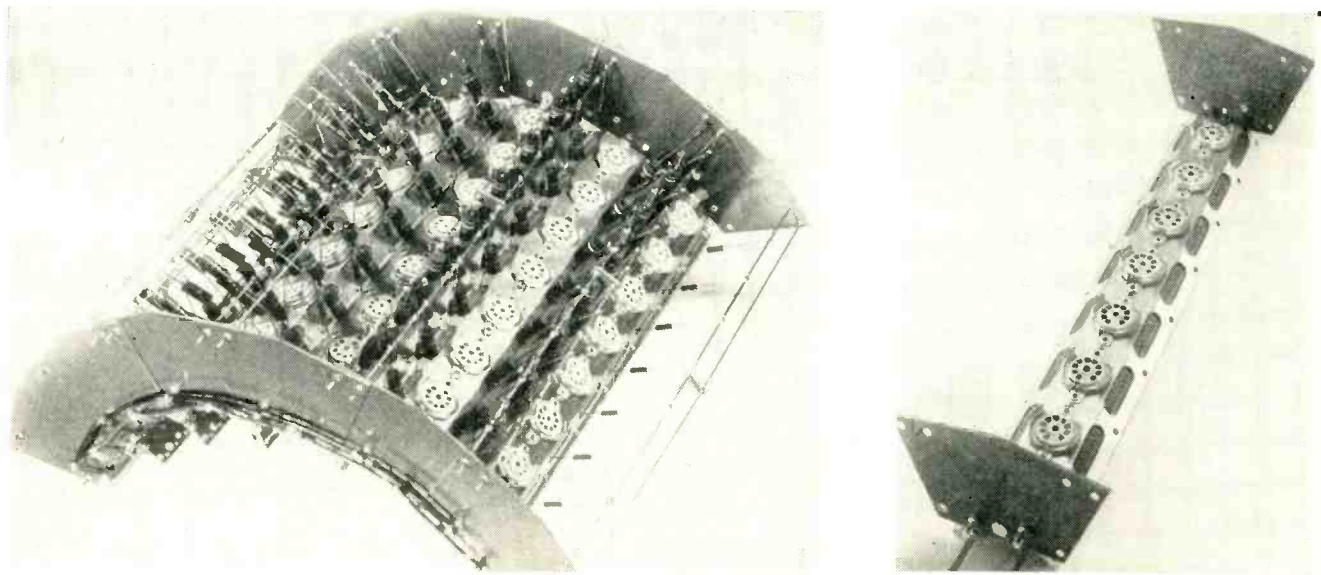

FIG. 1—Top view of six-gang chassis using basic chassis shown at right. Closeups of assembly are shown in Fig. 5 and 6

Basic Chassis for

EQUIPMENT DESIGNERS are faced with the necessity of producing small quantities of assemblies or families of units that can be basically similar but must be individually flexible. This situation is particularly true in research and development fields where each assembly usually must be special and unique.

Standard Chassis

Figure 1 illustrates a major assembly of six standard chassis, of which an individual unit is pictured in detail. Using these units as a basic chassis, adders, registers, digit resolvers, pulsers, amplifiers and various control units incorporated in the IAS computer have been produced. They provide an inexpensive and versatile basis for wiring experimental circuits in a minimum of time.

Design and subsequent modification of this basic chassis were based on a variety of requirements. The nature of the research decreed that any standard chassis adopted be: adaptable for serial, parallel and combined operation with other units; capable of accepting most, if not all, tube types commonly used in computer work; small; light; rugged; easily wired and serviced and capable of being produced in

reasonable quantity without recourse to expensive equipment. The wiring technique dictated that resistor leads be left a minimum of $\frac{3}{8}$ inch long and that they be laid in place without bending leads wherever possible. Elimination of hook-up wire, adequate ventilation and minimum interconnection distances between adjacent tubes and units were also given weight.

Statistical analysis of the program established that 7 and 9-pin miniature tubes would be used in most circuit applications and any chassis accepting both sockets, in common and in combination, would satisfy this requirement.

Composition resistors, mica and ceramic capacitors and crystal diodes emerged as supplementary components whose comparative size and application posed no real problems. This information completed the component picture and there remained only the determination of size and choice of shape. It was chosen to incorporate eight stages in the basic chassis since this number seemed to be a maximum as well as common size. The trapezoidal shape was chosen for its semichannel shape, which imparts rigidity to the unit and lends itself to a curved assembly (Fig. 1) that vastly simplifies parallel wiring. Finally, a

few well-placed holes in the main insulator permitted transfer of some of the components to the upper side of the chassis thus relieving congestion around the tube socket.

Chassis Construction

The basic chassis assembly evolved from the above criteria is shown assembled and disassembled in Fig. 2. The chassis proper is formed from 0.032-inch aluminum alloy (52S half hard) and the spacer and insulators are formed from nylon-base Bakelite. All of these parts are produced from dies made in the model shop. An estimated 150 man-hours of shop time were required to fabricate the entire set of dies.

Starting with an aluminum blank $2\frac{1}{8}$ in. wide by 12 in. long, eight $\frac{3}{4}$ -in. socket body holes are punched with one stroke of a 4-ton press. The die assembly contains eight punches staggered vertically so no more than two punches are shearing the metal at any one time. This was done to avoid overloading the press.

A second die punches all of the socket mounting lug holes, center insulator mounting holes and edge holes in one pass. Oblong slots on either side are piloted on the $\frac{3}{4}$ -in. holes and punched progressively. These slots serve as clearance holes

SUMMARY — Universal unit is used as basic chassis for computer adders, registers, digit resolvers, pulsers, amplifiers and other control units. Design of chassis and details of fabrication permit small production runs of complex electronic equipment with minimum mechanical work by engineer

By N. M. EMSLIE

*Electronic Computer Project
The Institute for Advanced Study
Princeton, New Jersey*

Experimental Work

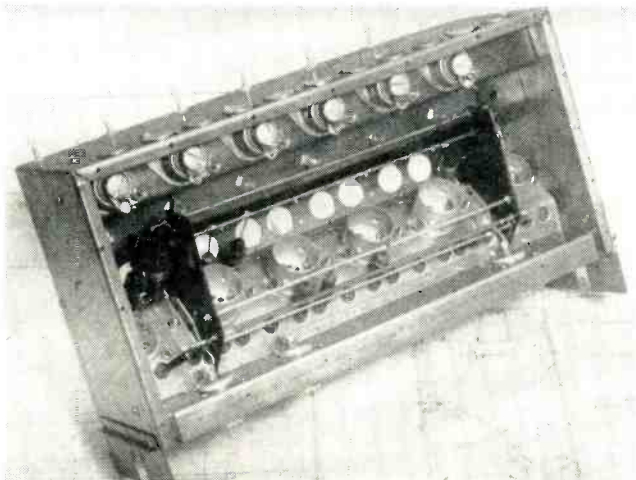

Prototype model of basic chassis installed in shielded assembly

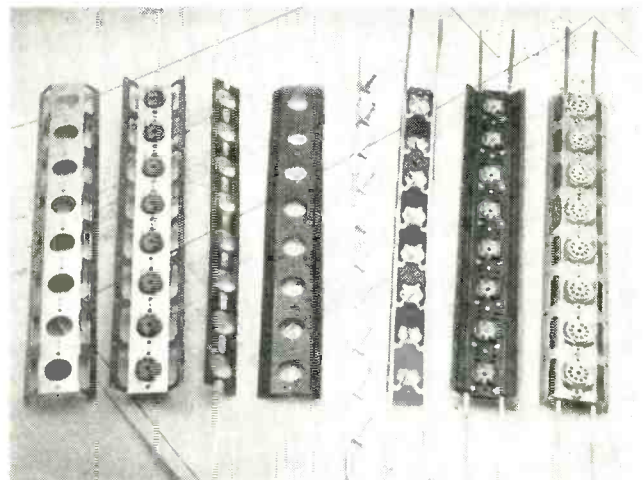

FIG. 2—Exploded view of basic chassis shows components

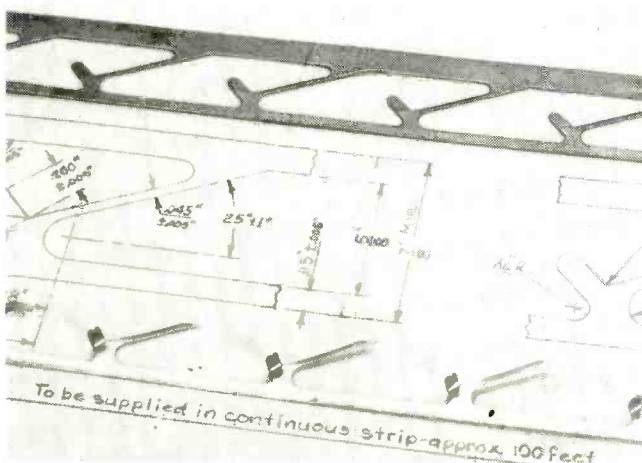

FIG. 3—Filament bus strips as blanked (top) and trimmed for use

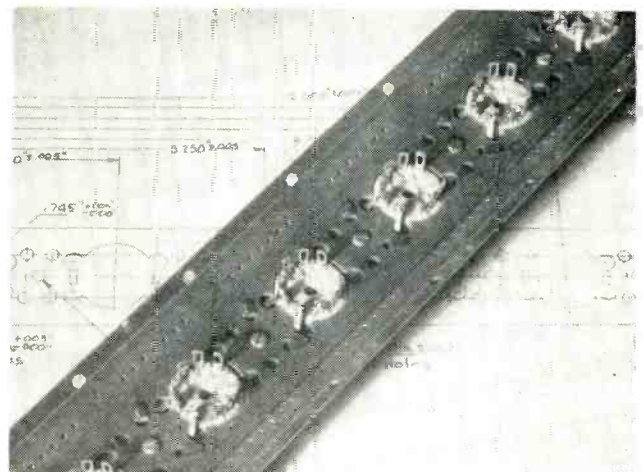

FIG. 4—Closeup of filament-bus connections to 9-pin sockets

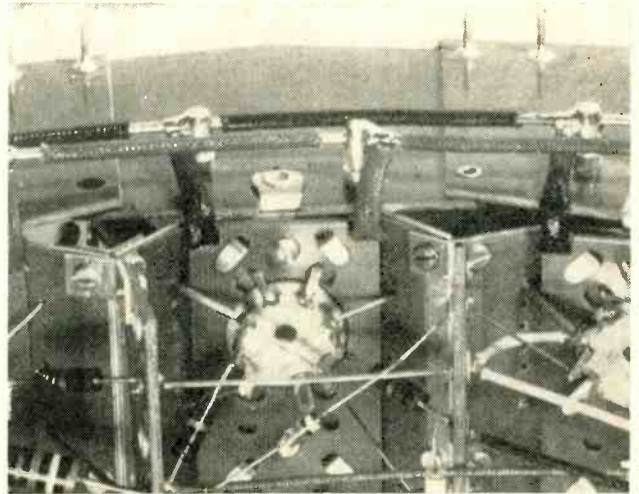
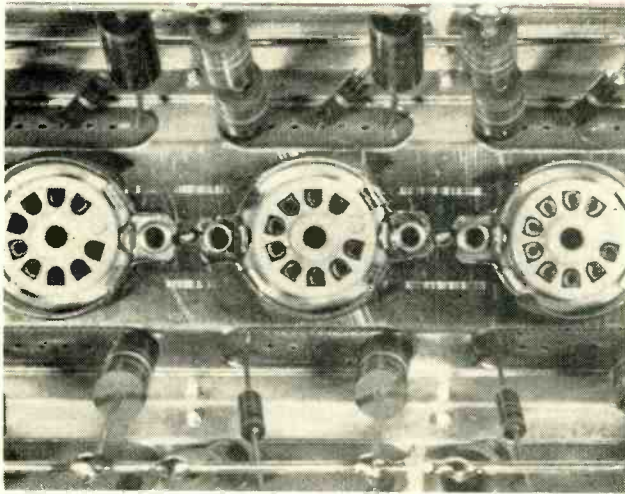

FIG. 5—Top-view closeup of multigang assembly of basic chassis

FIG. 6—Bottom-view of multigang assembly of basic chassis

for resistor leads brought to the upper side of the chassis through holes in the main insulator. Forming to the trapezoidal shape is also done on the punch press.

Socket Mounting

One manufacturer makes a 7-pin socket with the same mounting hole dimensions as their 9-pin socket. It was found practical to mount the 7-pin socket in the hole punched for a 9-pin socket. The only objection to this procedure is the gap left between the $\frac{3}{8}$ -inch diameter socket body and the $\frac{1}{4}$ -inch diameter hole in the chassis, which was a possible solder and dirt trap. The 0.016-inch bakelite spacer was designed to overcome this condition and to serve another function besides.

This spacer is punched in two variations, the first with eight $\frac{1}{4}$ -inch holes punched in the same die used to punch the metal chassis and the second with eight $\frac{3}{8}$ -inch holes. Both variations have the oblong slots which span and clear the two eyelets on adjacent sockets. The spacer then serves as a shim to prevent the main and filament insulators from being distorted by the eyelet heads when they are drawn up against the metal chassis.

In the assembly of a chassis with 7-pin sockets, the spacer with the $\frac{3}{8}$ -inch hole is used, not only as a shim but also to close the gap between the $\frac{1}{4}$ -inch hole in the chassis and the smaller body of the socket. Where 7 and 9-pin sockets are mixed on one chassis, a hand-operated punch can be used to enlarge the necessary number of $\frac{3}{8}$ -

inch holes to $\frac{1}{4}$ -inch diameter in a minimum of time.

The main insulator is first punched to fit 9-pin socket bodies. In the second operation, seven 0.050-inch diameter holes are punched in the skirt on each side of every socket hole. When this insulator is bent and assembled each of these groups of holes centers in an oblong slot in the metal chassis. The holes are so located that a resistor lead can be wired from the upper side of the chassis directly to any tube pin without bending the lead.

Folds in this 0.015-inch nylon-Bakelite insulator are postformed in a crude aluminum die. Although nylon-base Bakelite is not normally regarded as a suitable postforming material no difficulty is encountered with the thin sheet used. Ordinary soldering irons inserted in holes in the male and female die blocks provide sufficient heat to do the forming.

Filament-Bus Strip

Figure 3 shows the ladderlike shape of the copper filament-bus strip as it comes from the press and the finished strip with the excess metal sheared off and the rounded nosed clinching tabs bent for insertion into the insulator. An 0.015-inch by $\frac{3}{4}$ -inch continuous copper coil is fed into the die and blanked, one hole at a time, cut into 14-inch lengths and the excess trimmed on a shear. As yet, a use has not been found for the unusually shaped end slugs that are left.

Figure 4 illustrates the method of clinching the bus strips to the in-

ulator and the ease with which they can be connected to the socket pins. This completes the basic chassis, the parts of which are produced in quantities of 200 in 3 days.

The basic chassis can be tied to adjacent units by an aluminum angle tie strip, visible in Fig. 5, to form an assembly of up to eight chassis. In any such assembly the shaped-end bulkheads (Fig. 1) are eyeletted together where they overlap to supporting cathode and plate busses and stiffen the assembly. Initially, end bulkheads were fabricated in one piece, there being a different type of bulkhead for each type of assembly (single chassis bulkhead, two-gang bulkhead, etc.). This practice was inefficient and four-gang and larger units were difficult to assemble due to tolerance buildups. The present end bulkhead is easy to make, economical of material and can be assembled easily, regardless of chassis bend tolerances. Figures 5 and 6 are closeups of wiring on the top and bottom of a multigang assembly that illustrate the simplicity of wiring and ease of accessibility. Note the eyeletted terminal boards erected at the intersection of the chassis (Fig. 6). This greatly facilitates neat wiring and guides and supports interstage wiring.

During the past few years about 1,000 of these basic units have been fabricated. Three other laboratories have built computers based on the IAS computer and have used the same design successfully, not only in the machines but for experimental and breadboard circuitry.

Ultrasonic Switch Aids Diversity Reception

SUMMARY — Adapter that can be used with two conventional receivers, either a-m or f-m, requires little or no modification to existing equipment. Crosstalk from rejected channel is down 40 db

By **G. FRANKLIN MONTGOMERY**

National Bureau of Standards
Washington, D. C.

CONNECTION of two existing a-m or f-m receivers to operate effectively in dual diversity without extensive modification of the receivers themselves is possible with the adapter shown.

The local oscillator generates two out-of-phase square-wave voltages at ultrasonic frequency. Each voltage is used to key two modulators. The first modulator accepts the d-c output of one of the two receivers, and the second accepts the audio output.

The output of each d-c modulator is a square wave whose amplitude varies linearly with the d-c input. The two modulator outputs are out of phase. When they are added, therefore, a square wave is obtained whose amplitude is proportional to the difference of the two d-c inputs and whose phase indicates the sign of the difference. This difference square wave is amplified by the difference amplifier.

The output of each audio modulator is a square wave, clamped to a fixed potential during its positive half-cycle, whose amplitude is proportional to the instantaneous value of the audio signal from one receiver. The two audio modulator outputs are out of phase. When they are added, an alternating sequence of samples of the audio signals from the two receivers is obtained. This sequence is fed to an audio amplifier that is gated on by the amplified square-wave difference voltage.

Output of the gated audio ampli-

fier is thus a sequence of samples, at the ultrasonic frequency, of the audio signal from either one receiver or the other. The selected receiver output depends upon the phase of the square-wave difference voltage and the circuit is arranged so that the selected audio output is that from the receiver having the greater d-c output. The filtered output of the gated audio amplifier is used to drive a power output stage.

Narrow Crossover

In any diversity system, there is a crossover range of signal amplitudes in which the audio outputs of

both receivers are present simultaneously. In the adapter discussed here, this crossover range may be made as small as desired by providing sufficient gain in the difference amplifier. Maximum switching rate can be half the local oscillator frequency.

In this model, selection occurs for a range of direct input voltages from 0 to 15 volts, and the crossover range is less than 0.25 volt, at full gain settings. The required sinusoidal audio input (full gain) is 0.5 volt rms. Crosstalk from the rejected audio input is 40 db below the selected input.

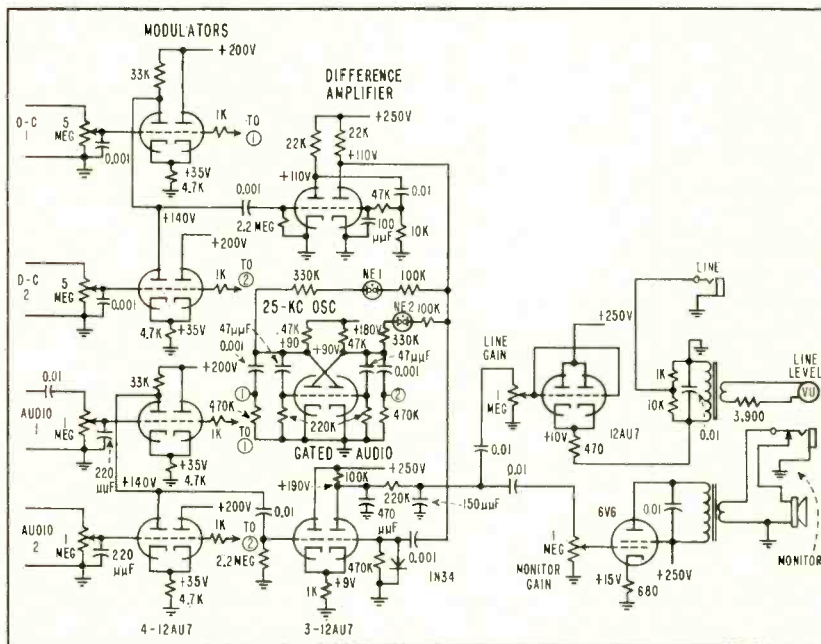

Circuit diagram shows simplicity of method used to obtain optimum signal from two receivers with good rejection of weaker signal. Neon lamps show which receiver has stronger signal

Square-Law Detector

By JAMES W. SAUBER

Project Engineer
Ballantine Laboratories, Inc.
Boonton, New Jersey

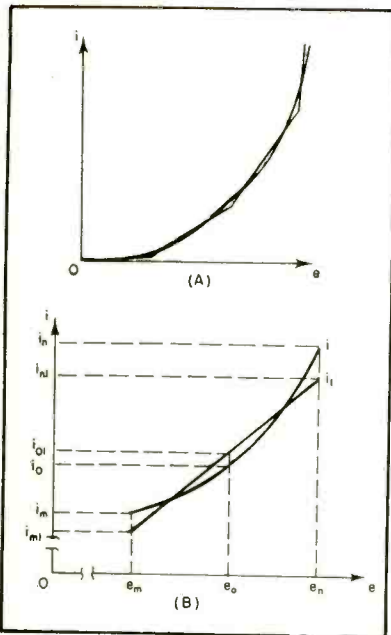

FIG. 1—Square-law characteristic showing segmented approximation (A) and isolated segment (B)

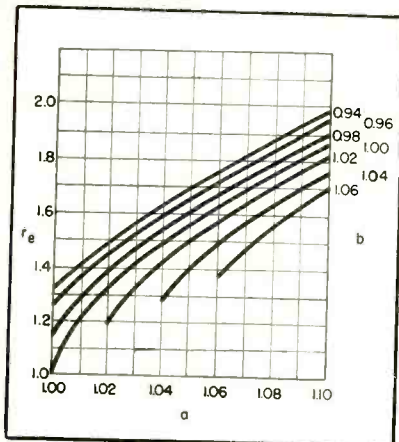

FIG. 2—Detector design chart plot of error functions vs. segment voltage ratio r_e . Curves are plot of Eq. 6

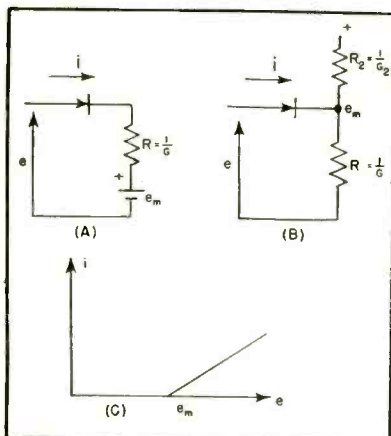

FIG. 3—Typical biased-diode circuits (A) and (B) and their response (C)

THE REALIZATION of a true root-mean-square voltmeter for sensitive wide-band measurements of nonsinusoidal waveforms is made difficult by the detector requirements.

Some means of achieving a square-law response must be provided. As an electrical network the detector may have two or more terminals, with input and response as voltages or currents. Response may be proportional to the square, the mean-square or the root-mean-square of the input. The detector may be unilateral or bilateral, but in any case a squaring characteristic is essential.

A square-law characteristic can be synthesized from linear resistors in combination with voltage-biased diodes. The parabolic characteristic is thus approximated by a continuous sequence of linear segments. The degree of approximation may be made as high as desired through the use of more segments.

Dynamic amplitude range is limited only by the quality of the diodes. The diodes act only as voltage-actuated switches, their own nonlinear characteristic having a second-order effect on the synthesized square-law characteristic.

Crystal diodes have finite back resistance and may be somewhat temperature sensitive. Nevertheless, the synthesized square-law detector incorporating crystal diodes is affected by temperature to a much lesser extent than thermocouples.

The detector used in this true-rms voltmeter is of the segmented-approximation type using high back-resistance germanium diodes in a circuit wherein the effects of crystal imperfections are minimized and for which there is no zero-signal current to be balanced out.

This squarer accepts positive voltage signals from a full-wave rectifier and responds in a current instantly proportional to the square of the input voltage. This current is

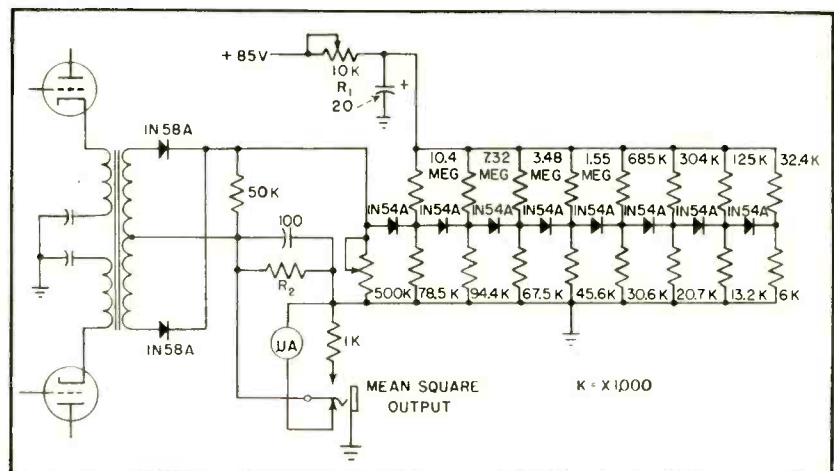

FIG. 4—Square-law detector providing a total of nine line segments with the first segment variable to allow adjustment of the square-law characteristic

for RMS Voltages

SUMMARY — Voltmeter uses series string of biased diodes to maintain operation on square-law segment of operating curve. Instrument covers range from μ volts to 320 volts at frequencies from 5 cycles to 500 kilocycles

passed through a sensitive d-c microammeter which is bypassed to the alternating component of the response.

Square Law Approximation

A current-versus-voltage square-law characteristic, with its segmented approximation, is shown in Fig. 1A. A typical isolated segment is shown in Fig. 1B. Ideally, the characteristic equation is

$$i = Ke^2 \quad (1)$$

where K is a proportionality constant. Therefore, at the points e_m, e_o and e_n , representing the voltages for which the approximation errors are to be greatest

$$i_m = Ke_m^2, \quad i_o = Ke_o^2, \quad i_n = Ke_n^2 \quad (2)$$

Let p_m, p_o and p_n be these maximum errors and let the added subscript l stand for the linear approximation. In terms of the square-law points the approximation points are

$$\begin{aligned} i_{ml} &= (1 - p_m) i_m & (3) \\ i_{ol} &= (1 + p_o) i_o \\ i_{nl} &= (1 - p_n) i_n \end{aligned}$$

It is convenient to use the segment voltage ratio r_e and the error functions a and b where

$$\begin{aligned} r_e &= e_n/e_m & (4) \\ a &= (1 + p_o)/(1 - p_n) \\ b &= (1 - p_m)/(1 - p_n) \end{aligned}$$

Substitute Eq. 2 into Eq. 3 and then into the standard equation for a straight line. The linear approximation can be expressed as

$$i_l = K(1 - p_m)e_m^2 \left[\left(\frac{r_e^2}{b} - 1 \right) \times \left(\frac{e}{e_m} - 1 \right) + 1 \right] \quad (5)$$

The maximum errors and the seg-



Voltmeter allows 100- μ v signal to be detected with a noise level of 12 μ v's

ment voltage ratio r_e are related by $r_e^4 - 4ar_e^3 + [4a + b(4a - 2)]r_e^2 - 4abr_e + b^2 = 0 \quad (6)$

Equation 6, plotted in Fig. 2, is an important design equation, for upon specification of the desired maximum errors the segment voltage ratio is determined.

For the important special case where it is desired that the maximum positive error to be equal to the maximum negative errors, $a = 1 + p_o/1 - p_o$ and $b = 1$. For $p_o = 0.02$, corresponding to a maximum root-mean-square error of 1 percent, $r_e = 1.494$, and ten such symmetrical segments end to end span an overall voltage-ratio range of $(1.494)^{10} = 55$. The corresponding current-ratio range is approximately 3,000.

In some cases it may prove advisable to specify a restricted amplitude range of small errors and permit progressively larger errors for the adjacent amplitude ranges above and below the restricted

range. It is only necessary to see that the end point errors p_m and p_n are matched between adjacent segments. The total voltage-ratio range is the product of the individual r_e 's.

In general, the detector-response error will be less than the maximum design errors, since the response to a sine wave, for example, will include a succession of alternating positive and negative errors tending to cancel each other. The most severe test is the response to a square wave or other flat-topped pulse.

Detector Network Design

Assuming that the diode in Fig. 3A has zero forward resistance and infinite reverse resistance, current will not flow until the signal voltage e exceeds the bias voltage e_m . Thereafter, the current response is $G(e - e_m)$, G being the conductance of the resistance R , as shown in Fig. 3C.

In Fig. 3B the bias voltage is de-

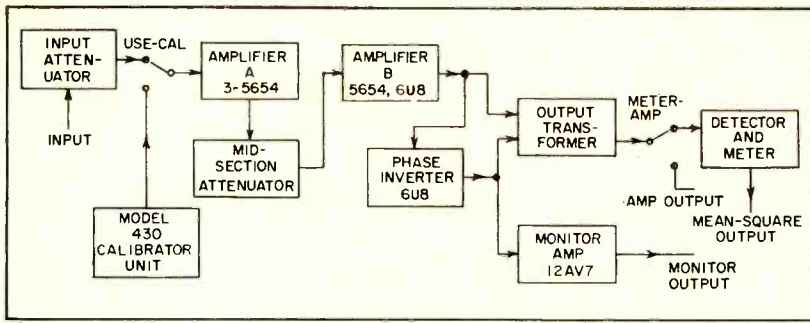

FIG. 5—Block diagram of root-mean-square voltmeter. The instrument is essentially an amplifier-detector

terminated by the ratio $G_2/(G_1 + G_2)$, and the current response by the combination $G_1 + G_2$. By connecting many such circuits in parallel and adding their current responses it is possible to approximate any first quadrant monotonically increasing function.

To derive the circuit values required for the square-law approximation it is necessary to determine the number of linear segments, each segment corresponding to a biased-diode circuit, on the basis of the desired overall voltage-ratio range and the amount and distribution of maximum errors.

Use Fig. 2 for finding r_e for each segment. Operating limits of voltage and current are then chosen, permitting specification of the proportionality constant K and the various segment biases e_m .

The slope of the approximation, from Eq. 5, is

$$\text{slope} = \Sigma G = K(1 - p_m)e_m \frac{r_e^2 - 1}{r_e - 1} \quad (7)$$

$$\Sigma G = K(1 - p_m) \frac{e_m r_e^2 - b}{r_e r_e - 1}$$

ΣG is the sum of all circuit conductances up to and including the one under consideration, and by taking the difference between successive values of these sums the individual circuit conductances are obtained. For the initial segment, which in the usual design is not biased

$$G = K(1 - p_n)e_n \quad (8)$$

Finally, the values of G_1 and G_2 as in Fig. 3B may be calculated for each circuit from G , e_m , and the voltage of the bias source.

The effect of linear series resistance R_s , such as resistance of the signal source, is to require modification of each conductance sum by

the factor $1/1 - R_s \Sigma G$, and in the subsequent calculation of G_1 and G_2 e_m must be modified by the factor $1 - K(1 - p_m)e_m R_s$.

To permit the use of semiconductor diodes a circuit similar to Fig. 4 was developed. Here the diode circuits are connected in tandem in the order of increasing bias voltages. The diodes are in series and each circuit receives its signal from the circuit immediately preceding it. Capacitances to ground are minimized.

If high back resistance and high forward-conductance germanium or silicon diodes are used, temperature effects will be small at worst, since the tandem arrangement is to a large extent self compensating.

To achieve wide-band response extending to as high a frequency as possible, control must be exercised over circuit capacitances since at the highest frequencies the circuit tends to peak detection.

Instrument Details

Figure 5 shows a block diagram of the complete instrument. Essentially, the voltmeter is an amplifier-detector type instrument; input signals are changed in voltage level by suitable amplifier-attenuator combinations before detection. The lowest measurable voltage is determined by the inherent noise of the instrument referred to its input. Noise of $12 \mu\text{v}$ is typical, and therefore a $100 \mu\text{v}$ signal may be detected by a square-law detector, after amplification, with less than 1 percent error from this source.

The upper limit of voltage measurements is 320-v rms. A signal of this amplitude and with a crest factor of 5 has a peak of 1,600 v, which is considered the voltage limit for the components and spe-

cific techniques employed.

The instrument therefore spans a voltage range of 130 db. Two separate compensated attenuators provide the requisite 120-db attenuation in 10-db steps.

The two amplifiers combined provide a total of 84-db gain with flat frequency response from 5 cps to 500 kc. Each amplifier is stabilized by negative feedback and power-supply regulation. In combination with a separately stabilized unity-gain phase inverter a balanced cathode-follower output is provided.

To effect complete d-c isolation between amplifier and detector circuits without impairing low-frequency response an output transformer is used, allowing the common point between detector and meter to be grounded.

The detector shown in detail in Fig. 4, is designed to provide controlled square-law performance over a 50-to-1 range of voltage amplitudes, corresponding to a current variation of 2,500 to 1. Full-scale meter current of $200 \mu\text{a}$ is obtained with a detector input of 5-volts rms.

Squaring is controlled up to 25-v peak, thereby allowing a signal with a crest factor of 5 to be measured at full scale, and larger crest-factor signals at down-scale points.

The effective bandwidth of the instrument for wide-band noise and pulse measurements is about 1 mc.

Note that total of nine segments are used, the initial segment being variable to permit exact adjustment of the square-law characteristic. The detector bias-supply control R_1 provides an effective variation of about 20 percent of the proportionality constant K . A thermistor shunt R_2 across the meter provides temperature compensation for the entire instrument.

Instrument error for sine-wave measurements is within 3 percent between 15 cps and 150 kc, and 5 percent between 5 cps and 500 kc. For complex waveforms within the crest-factor specifications the error depends only upon the distribution of harmonic frequencies within and without these frequency ranges.

The writer acknowledges the invaluable assistance of Walter Kram and J. R. Hansell of Ballantine Laboratories in the development of this instrument.

SHORTEST ELECTRICAL PATH TO THE GROUND...SIMPLIFIES WIRING...REDUCES SPACE REQUIRED BY CIRCUIT COMPONENTS—

A JOINT DEVELOPMENT OF ERIE RESISTOR CORP., AND CINCH MANUFACTURING CORPORATION,

now in universal use, commercial and military types, available in seven pin miniature, nine pin Noval, and Octal

Capacitors built into socket may be either by-passed to ground directly, or left open for coupling applications. On by-pass applications, ground strap contacting outer plate of capacitor is connected to metal chassis when tube socket is mounted.

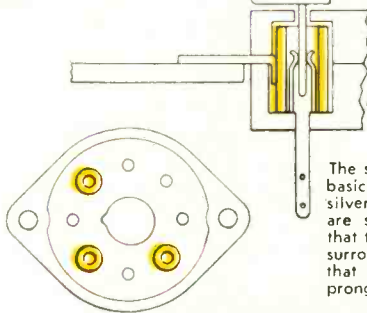

The schematic diagram shows basic design principle. The silvered ceramic condensers are shown in yellow. Note that the condenser completely surrounds the tube pin, and that specially designed tube prong terminals are used.

CINCH-ERIE

"Plexicon"

VACUUM TUBE SOCKET

With built-in ceramic condensers, Plexicon Tube Sockets, no larger than standard receiver socket, provide the most effective method of by-passing . . . with condenser close to tube element providing shortest path to the ground. . . . capacity up to 1,000 MMF—the tube element may be coupled or by-passed as desired.

Reduces set assembly costs—saves space; permits moving other components closer to tube socket. Where space and weight make compactness mandatory, as in airborne equipment, the Plexicon socket is the solution.

Cinch

ELECTRONIC COMPONENTS

CINCH components available at leading electronic jobbers—everywhere.



CINCH MANUFACTURING CORPORATION

1026 South Homan Ave., Chicago 24, Illinois

Subsidiary of United-Carr Fastener Corporation, Cambridge, Mass.

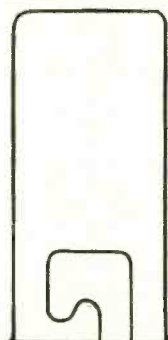

SHIELD

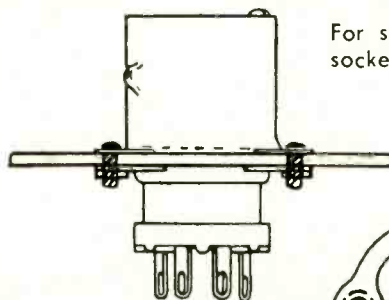

BAYONET SHIELD BASE

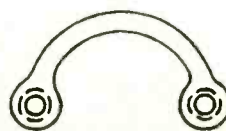

MOUNTING STRAP

For shielding tube, two types are available for miniature socket as shown, Bayonet with three lengths of shield cans available and Snap-on, two lengths of shields available. Bayonet type shown here.

The Mounting strap is a CINCH development for ease and simplicity in mounting miniature sockets. One strap nut takes the place of two conventional type nuts and is generally used in assembling sockets having attached base.

Write for detailed information

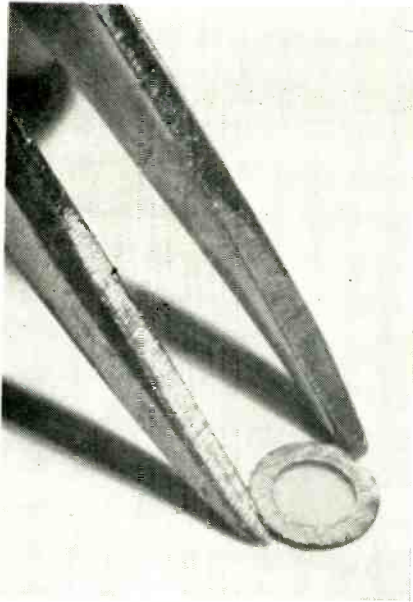

Machine-wound grid structure has 1,000 turns per inch

while reduced interelectrode capacitance and minimum lead inductance enhance use of the tube at uhf. The new ceramic is said to minimize r-f losses.

Solar Battery Powers Telephone Carrier



Rural telephone line now carries several circuits using transistor amplifiers powered by solar generator atop pole

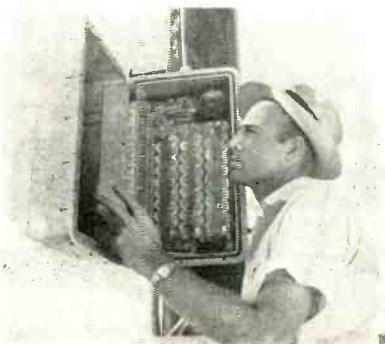

AEW Planes Keep Continuous Watch



Radar sentry plane picks up information on location of unidentified planes and surface craft



Early warning aircraft fly radar equipment as they patrol east and west coastal areas. Combat Information Officer (below) co-ordinates search work

RADAR watch, limited generally to line-of-sight distance, can be extended by pushing lookout stations beyond the perimeter of the protected area and by increasing the effective horizon. Both these steps can be resolved by use of high-flying aircraft.

The U.S. Navy and Air Force use Lockheed Super Constellations carrying 6 tons of radar equipment. Crews of 31 men man the aircraft for round-the-clock operations. The project is known as airborne early warning (AEW).



IMPROVED rural telephone service using carrier currents on so-called thin or skinny routes has been made possible through the develop-

Storage battery operates low-current transistor equipment during night. It is charged by solar battery that powers equipment during day

ment of transistor equipment. With current drain reduced as compared with electron tube equipment, it is possible to power remote amplifiers from the recently developed Bell Labs solar battery.

When the solar charger is backed up by storage cells, periods of bad weather or darkness, during which

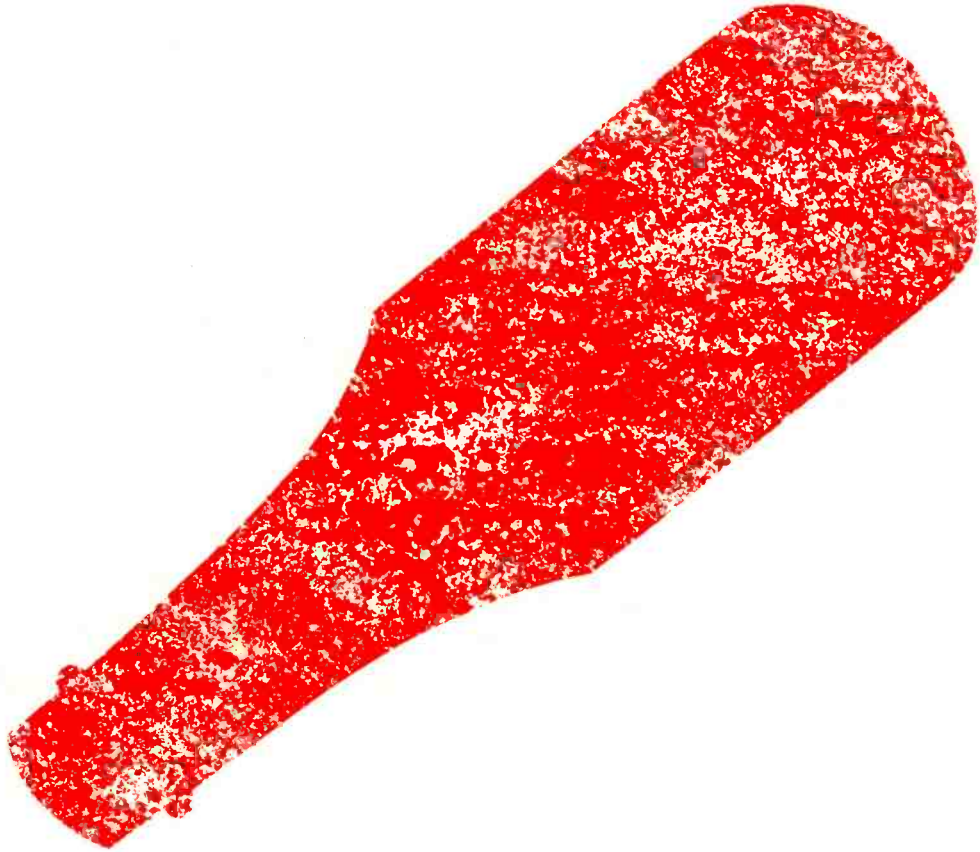

no ketchup needed

When a predestined steer meets a dedicated chef ... man, that's steak!
If steer or chef is bad (and double trouble if both) ... ketchup can't help.
Now comes the commercial.

Take the best available materials (sifted by unrelenting research).
Season with the same inventiveness used by Dr. A. O. Beckman to develop
the precision potentiometer in 1940 (we've never switched brands).
Add assembly-line economies without compromising quality. Test and
retest in the industry's most complete lab. Inspect a dozen times
(too many cooks can't spoil *this* broth). Pack well. Ship on schedule.
Man, that's a HELIPOT precision potentiometer ... no ketchup needed!



first in precision potentiometers
Helipot Corporation / South Pasadena, California
Engineering representatives in principal cities
a division of BECKMAN INSTRUMENTS, INC.



*Helipot makes precision potentiometers...
linear and non-linear ... in the widest choice
of sizes, mounting styles and resistances.
Many models are stocked for immediate
shipment... our engineers will gladly adapt
standard models to your requirements...
or design entirely new HELIPOT* precision
potentiometers for you.
For information and specifications...
write for data file 1101.*

536 *REG. U.S. PAT. OFF.

THE FRONT COVER



MANUFACTURE of color kinescopes of the shadow-mask type requires that three phosphors be laid onto the screen in a dot pattern. The process used for black-and-white kinescopes provides for suspension deposition of the phosphor over a period of time. To speed up the process for color tubes, RCA uses three color-producing phosphors combined with polyvinyl alcohol, deionized water and a photosensitizing agent.

Applied centrifugally as a slurry to the cap of

the color kinescope, each solution is distributed as shown on the cover and the photograph at the left.

When the glass cap is taken out of the slurring machine, it is affixed to its individual shadow mask and placed on a so-called lighthouse as shown at the right. The light dots expose the phosphor and fix it photographically. Excess phosphor is washed off and the glass plate is then put through two more similar steps to obtain the other two sets of dots. Colors are red, green and blue.

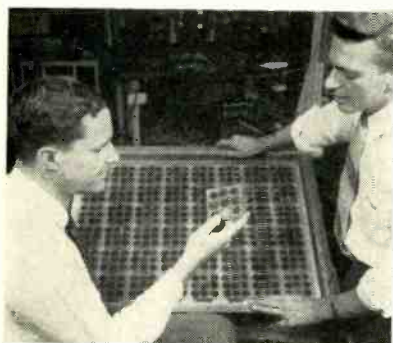

Silicon disks assembled in modules of nine deliver power at the rate of 100 watts per square yard of effective surface area

the solar battery is weak or inoperative, offer no problem.

Such an installation is now furnishing rural multicarrier telephone service near Americus, Ga., for Southern Bell Telephone Co.

The Bell solar battery comprising 432 silicon cells cushioned in

Albion Tries Commercial TV

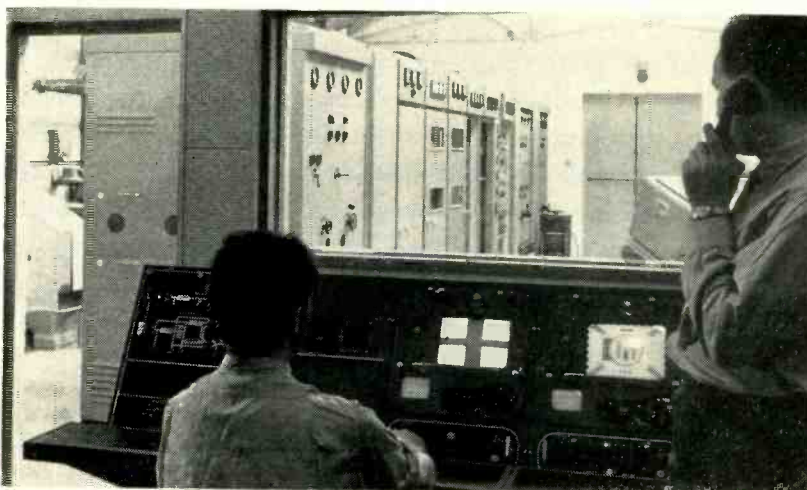

London station of the Independent Television Authority (ITA) began full-scale commercial television on Sept. 22, 1955. Such programming is effectively in competition with that of government-sponsored British Broadcasting Corp., until recently a monopoly. Control desk, with transmitter beyond, was built in Croydon by Marconi's Wireless Telegraph Co., Ltd. ERP of station is about 60 kw

A COMPLETE LINE OF DEPENDABLE ENCAPSULATED RESISTORS



PERMASEAL®

PRECISION, WIREWOUND RESISTORS FOR 85° AND 125° AMBIENTS

You can choose from 46 standard designs in tab and axial lead styles to meet requirements for all types of military and industrial electronic apparatus and instruments.

This complete line of PermaSeal Resistors is designed for applications which require highly accurate resistance values in small physical size at 85°C. and 125°C. operating temperatures.

Protected by a special Sprague-developed plastic embedding material, PermaSeal Resistors provide maximum

resistance to high humidity (they meet severe humidity requirements of MIL-R-93A and proposed MIL-R-9444 USAF).

The winding forms, resistance wire, and embedding material are matched and integrated to assure long term stability at rated wattage over the operating temperature range.

These high-accuracy units are available in close resistance tolerances down to 0.1%. They are carefully and properly aged for high stability by a special Sprague process.

SPRAGUE

FOR COMPLETE DATA
WRITE FOR COPY
OF SPRAGUE
ENGINEERING
BULLETIN NO. 122A



SPRAGUE ELECTRIC COMPANY • 35 MARSHALL ST. • NORTH ADAMS, MASS.

ever meet
one of
our
Spring Engineers?

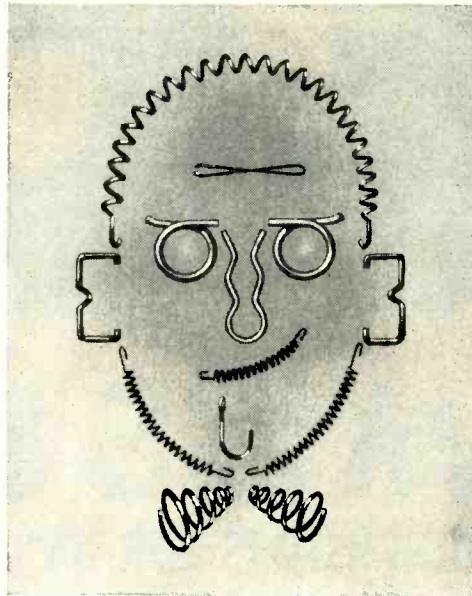

If you haven't, perhaps it's time you did. Our Spring Engineers don't have torsion springs for eyes or wire forms for ears, to be sure, but they know just about everything there is to know about designing the right spring for the job. That's hardly surprising in view of the thousands of tough spring problems that have been solved at lower cost by Lewis Spring Engineers.

If a spring is a vital part of your product, get acquainted with one of our Spring Engineers. Chances are good that he can show you how to realize maximum product performance at minimum cost with a Lewis spring that's engineered to the job. Behind his recommendation stand the experience, facilities and reputation of a company geared to serve you quickly and well.

LEWIS SPRING & MANUFACTURING COMPANY
2656 W. NORTH AVE. CHICAGO 47, ILL.

Lewis  **PRECISION
SPRINGS**

The Finest Light Springs and Wireforms of Every Type and Material

oil and covered by glass is about 15 times more efficient than previous solar converters. The cells convert as much as 11 percent of the energy they receive, a performance comparable to that of the best gasoline and steam engines.

Preferred Circuits Standardization

IMPROVED operational reliability, establishment of design standard levels and simplified maintenance training are among the advantages

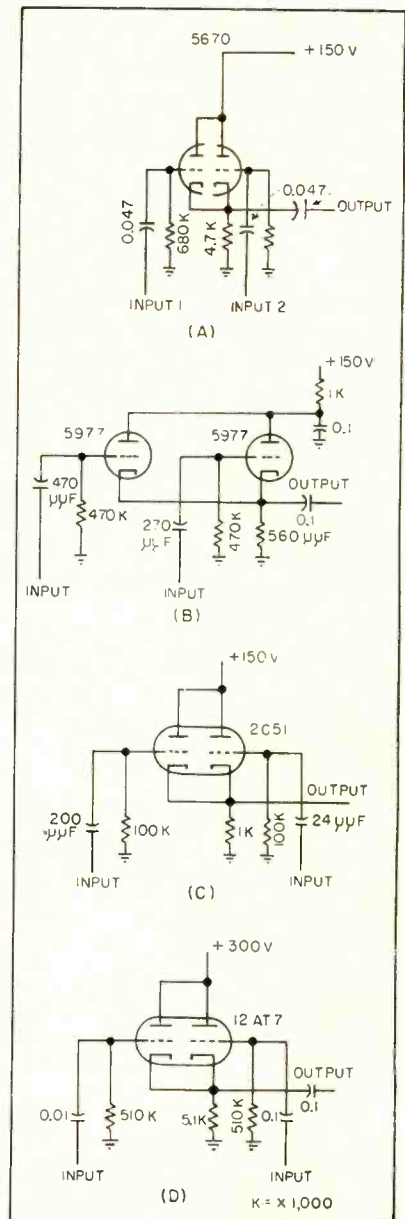

FIG. 1—Example of preferred circuit for mixing radar video signal with marker pulses (A). Three examples (B), (C) and (D) of the 22 video mixers found in radar sets

Federal's new germanium rectifier stacks—

a mighty handful of
DC power!



**Smallest, lightest, most rigid...
rated up to 565 volts DC and
up to 6 amps...1 to 12 fins
(Over 100 standardized combinations)**

The 1N91, 1N92, and 1N93 germanium rectifiers used in these new stacks assure at least 20% lower reverse leakage current than RETMA standards.

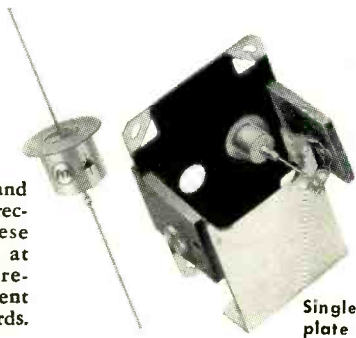

Single plate

Once in a while a new design is so good that it sets entirely new standards for an electronic component. The *new* Federal germanium stacks are like that. Here are seven of their most important advantages over existing types... advantages that mean a *better* rectifier for *your* equipment:

- **SPACE-SAVING**—The stacks average one-third shorter in length.
- **LIGHTWEIGHT**—Light, strong plastic side strips are used instead of heavy axial assembly bolts and insulators.
- **RIGID CONSTRUCTION**—Interlocking of fins and strips builds a "tight" structure unaffected by vibration.
- **BETTER HEAT DISSIPATION**—Full area of the fin is available for cooling.
- **TERMINAL LUGS ELIMINATED**—Terminals are stamped out as part of the fin corners, so that wires may be soldered directly to the fin.
- **NO PROTRUDING BUS BARS**—Corners of fins are clipped out for passage of bus bars connecting non-adjacent plates.
- **FULLY INTERCHANGEABLE**—Electrically and mechanically interchangeable with types now on the market.

For detailed information, ask for "Federal Germanium Power Stacks" booklet. Phone NUTley 2-3600 or write to Dept. F-213.

Federal



Federal Telephone and Radio Company

A Division of INTERNATIONAL TELEPHONE AND TELEGRAPH CORPORATION
COMPONENTS DIVISION • 100 KINGSLAND ROAD • CLIFTON, N. J.

In Canada: Standard Telephones and Cables Mfg. Co. (Canada) Ltd., Montreal, P. Q.
Export Distributors: International Standard Electric Corp., 67 Broad St., New York

to be gained by standardization of electronic circuits.

A program undertaken by National Bureau of Standards and Navy Bureau of Aeronautics seeks to determine well-known circuit configurations common to a wide variety of equipment. The purpose is to weed out unnecessary differences in detail. A full technical report will be available in November from the Government Printing Office. It will be titled "Preferred Circuits Man-

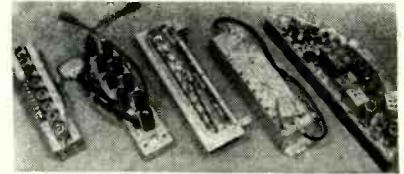

FIG. 2—Five if strips produced for Navy aeronautical equipment perform the same electrical functions

ual, Navy Aeronautical Electronics Equipment" and identified as NAVAER 16-1-19.

Some circuits are unique and specially designed for a purpose. Most circuits, however, are widely used in many equipments. Such widely used circuits become essential building blocks, like the elements of a block diagram. While it is not always advantageous to freeze circuit design, economies often result thereby in price, delivery time and reduction of spare parts.

Junior engineers who are often assigned the routine of designing well-known circuits will have their work facilitated, reducing, in turn, the supervisory burden of senior engineers.

Studies of 22 equipments showed essentially 60 circuit types. Although circuits within a type were not necessarily identical, in many cases they were similar enough for standardization. For example, certain range-marker generator circuits could well be identical for many radars and for other time-scale generators.

Power supply circuits were found capable of standardization. As a first step, studies were made of the large number of power supply voltages. It was discovered that voltages used in 20 equipments showed 20 different nominal values that could readily be reduced to four.

A typical preferred circuit for a

AMPHENOL

SUBMinax

**SUBMINIATURE RF CONNECTORS
and
SUBMINIATURE CABLE**

Weight-saving, space-saving SUBMINAX RF connectors! Obtain 500 rf circuits for each pound of weight using SUBMINAX, compared with 8 rf circuits for each pound of weight of equivalent Series N connectors! Space-saving: 7 SUBMINAX plugs occupy same space as 1 Series N plug!

Available in 50 and 75 ohm constant impedance—and in either push-on or screw-on coupling design. Complete line includes straight and right angle plugs, jack, cable feed through, bulkhead jack and receptacle. Hermetic seal receptacle in screw-on couplings only.

Cable assemblies with AMPHENOL subminiature coaxial cable easily accomplished with hand Crimping Tool—only two types needed for entire series.

AMPHENOL

AMERICAN PHENOLIC CORPORATION
chicago 50, illinois
In Canada: AMPHENOL CANADA LTD., Toronto



Save, save, save . . . time, trouble, money . . . when purchasing molybdenum permalloy* Powder Cores, for there can be no waste when you buy from Magnetics, Inc. Exclusively *Performance-Guaranteed*, these cores are also graded according to inductance, and color-coded so your assemblers *know* how many turns to put on without special testing. Write today for full details . . . Bulletin PC-103 and your Color-Coding Card . . . and remember . . .

PERFORMANCE - GUARANTEED

.....

Permalloy Powder Cores

COST NO MORE-

.....

WHY TAKE LESS?

MAGNETICS inc.



DEPT. E-24, BUTLER, PA.

*Manufactured under a license agreement with the Western Electric Co.

THERMOSTATIC DELAY RELAYS

Provide delays ranging from 2 to 150 SECONDS

A
M
P
E
R
I
T
E



STANDARD

**MOST COMPACT
MOST ECONOMICAL
HERMETICALLY SEALED**

- Actuated by a heater, they operate on A.C., D.C., or Pulsating Current.
- *Hermetically sealed.* Not affected by altitude, moisture, or other climate changes.
- Circuits: SPST only—normally open or normally closed.

Amperite Thermostatic Delay Relays are compensated for ambient temperature changes from -55° to $+70^{\circ}\text{C}$. Heaters consume approximately 2 W. and may be operated continuously.

The units are most compact, rugged, explosion-proof, long-lived, and — inexpensive! TYPES: Standard Radio Octal, and 9-Pin Miniature.

PROBLEM? Send for Bulletin No. TR-81

Also—a new line of Amperite Differential Relays — may be used for automatic overload, over-voltage, under-voltage or under-current protection.



MINIATURE

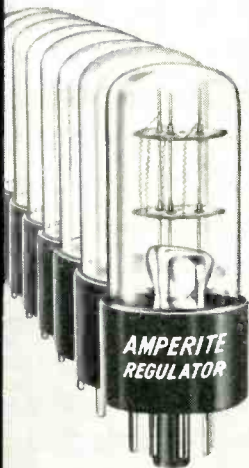

T9 BULB

BALLAST REGULATORS

- Amperite Regulators are designed to keep the current in a circuit *automatically regulated* at a definite value (for example, 0.5 amp).
- For currents of 60 ma. to 5 amps. Operates on A.C., D.C., or Pulsating Current.
- Hermetically sealed, light, compact, and most inexpensive.

Amperite Regulators are the simplest, most effective method for obtaining *automatic regulation* of current or voltage. *Hermetically sealed*, they are not affected by changes in altitude, ambient temperature (-55° to $+90^{\circ}\text{C}$), or humidity. Rugged; no moving parts; changed as easily as a radio tube.

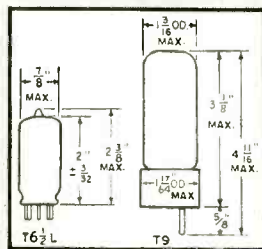
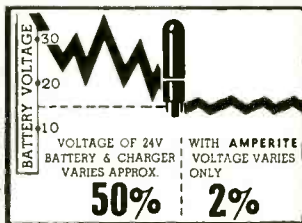

AMPERITE CO., Inc.

561 Broadway, New York 12, N. Y.

In Canada: Atlas Radio Corp., Ltd., 560 King St., W., Toronto 2B

Write for 4-page
Technical Bulletin
No. AB-51

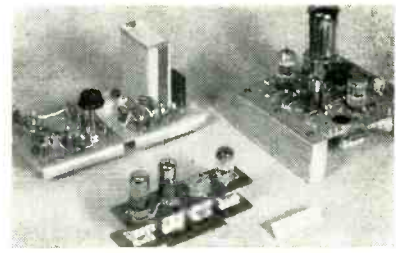

FIG. 3—NBS-BuAer preferred circuits are adaptable to different methods of construction as shown in different fabrication techniques

radar video mixer is shown in Fig. 1A. That at (B) is a common-cathode mixer combining pulses representing range markers and heading markers. In Fig. 1C a common-cathode mixer combines two positive polarity range strobe triggers. The circuit in (D) combines 9-v positive polarity range markers with 2-v to 10-v positive iff signals.

Flat Cathode-Ray Tubes

DISPLAYS using cathode-ray tubes of unusual design have been described previously (ELECTRONICS, p 7, Feb. 1955 and p 214, Mar. 1955). Technical information recently made available from Kaiser Aircraft and Electronics Corp. summarizes some aspects of function and design.

In its simplest form, the tube comprises a phosphor screen, a set of horizontally disposed deflection plates and an electron gun placed below them. The electron beam from the gun is deflected in a plane parallel to the phosphor screen and slightly behind it.

Under the condition that the deflection plates are at the same voltage as the phosphor screen, the beam will sweep the entire area between the phosphor screen and the vertical deflection plates. The deflected beam will pass behind the phosphor screen until it reaches a field created by one of the vertical deflection plates being at voltage lower than the phosphor screen. The beam will be deflected into the phosphor screen at that point.

Owing to its horizontal deflection at the gun the beam will describe a horizontal line on the phosphor screen. If the voltage on each of the several vertical deflection plates behind the phosphor screen is varied, a negative field, created by these de-

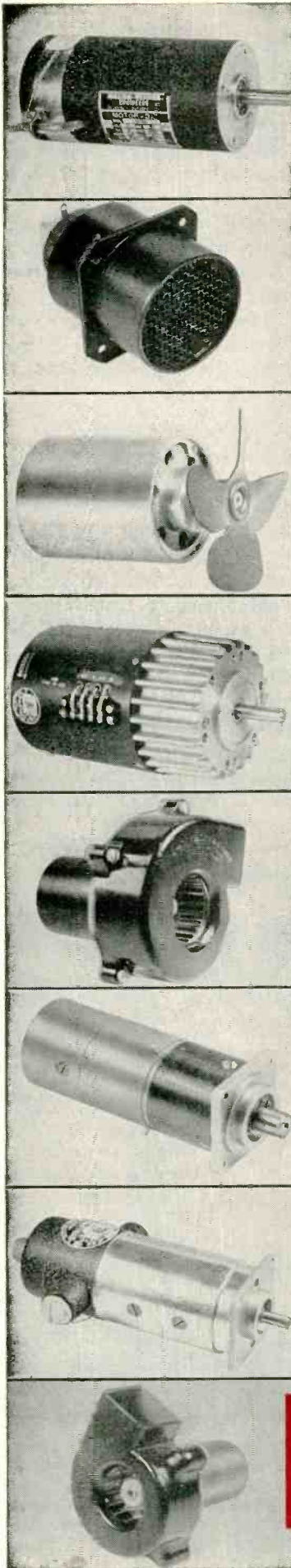

BE SURE OF
RELIABILITY!
 SPECIFY
WESTERN GEAR
 MINIATURE
 ELECTRICAL ROTARY
 EQUIPMENT

HERE ARE
9 REASONS WHY!

- die-cast aluminum housings for rigidity
- ball bearings throughout
 - stainless steel through bolts
- bonded stators for greater strength
- full protection against humidity and fungus growth
 - meet or exceed all AN specifications
- constant inspection and 100% performance testing
- continuing research program to improve techniques and manufacturing methods
- complete engineering service to insure correct application

More than 50 basic motor designs, including axial and centrifugal blower designs, ranging from .001 to 2 HP, from 50 to 1,000 cycles, any voltage range, to fill virtually any specification. Please detail your requirements. Our engineers will make recommendations promptly. Write Executive Offices, Western Gear (Electro Products Division) P.O. Box 182 Lynwood, California

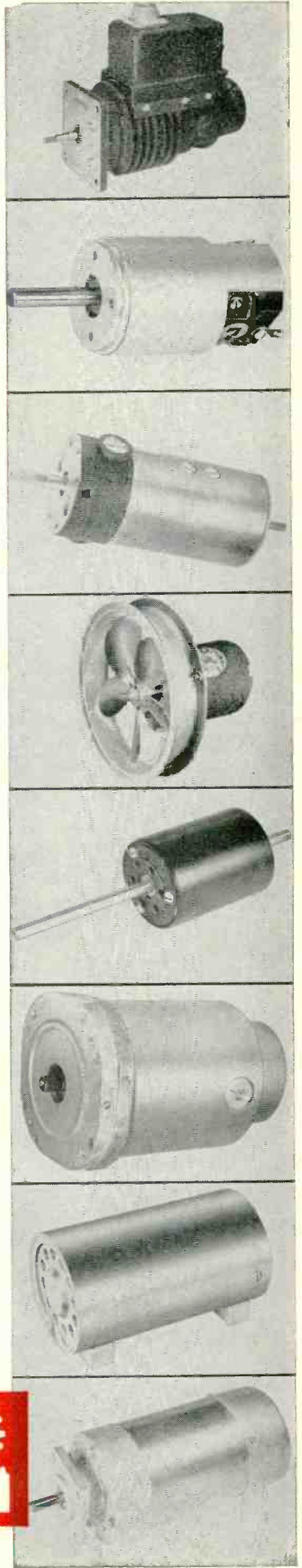

"The difference is reliability" * Since 1888

WESTERN GEAR 
 PACIFIC-WESTERN PRODUCTS | POWER TRANSMISSION
 GEARS • MACHINERY •

PLANTS AT LYNWOOD, PASADENA, BELMONT, SAN FRANCISCO (CALIF.)
 SEATTLE AND HOUSTON — REPRESENTATIVES IN PRINCIPAL CITIES

Now Available!

New M-21 "McMite" Sub-Miniature Quartz Crystal

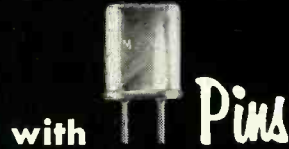

Latest addition to the McCoy line of high quality, precision quartz crystals is the new M-21 "McMite" . . . with .040" dia. pins. The new M-21 supplements its twin brother, the M-20 "McMite" which has wire leads. Together, these two crystals offer extreme adaptability to designers of multi-channel communications and frequency control equipment. The M-21 plugs into a sub-miniature socket while the M-20 can be wired or soldered to a printed circuit terminal board. Both may be incorporated into miniature selector switch assemblies. The M-20 and M-21 crystals are sub-miniature, hermetically sealed units which deliver the same performance as larger, regular size crystals, yet require only one-fifth as much space. Both meet military specification requirements for fundamental operation above 5 mc. and overtone operation above 15 mc. Neither sacrifices stability or dependability but meets the same characteristics and performance requirements as the conventional larger crystal units.



Six M-21 units plugged into a 1 3/4" strip of sockets (left) and ten M-20 units wired into a 2" dia. switch assembly (right) illustrate the space saving qualities of the McCoy "McMite" crystals.

McCoy ELECTRONICS CO.

MT. HOLLY SPRINGS, PA.
Phone 376 and 377

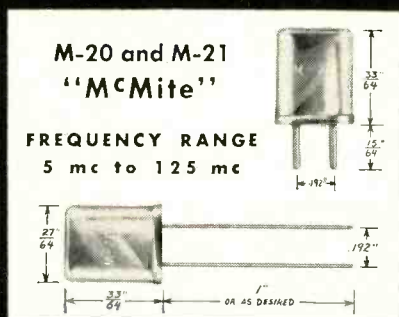

deflection plates, will move smoothly from the top of the tube to the bottom. It is necessary that the voltage on each plate be dropped uniformly and that the voltage on the next lower plate start to drop just as the voltage on the previous plate reaches a minimum so that a noninterrupted flow of the negative field will occur. Seven to ten plates are normally enough for adequate control. The focusing action of this field brings the beam to a small horizontal line at the surface of the screen with great power.

Two-Bend System

In a two-bend model of the new tube, the electron gun is placed to inject a beam below the tube and midway between the extension of both the phosphor screen and the bottom vertical deflection plate. In this arrangement, transverse deflection plates on the bottom side of the beam deflect the beam upward into the area behind the phosphor screen. This lower portion of the tube is normally operated at set voltage or slightly above.

An isolating electrode is needed. Voltages on the horizontal deflec-

British TV Tower

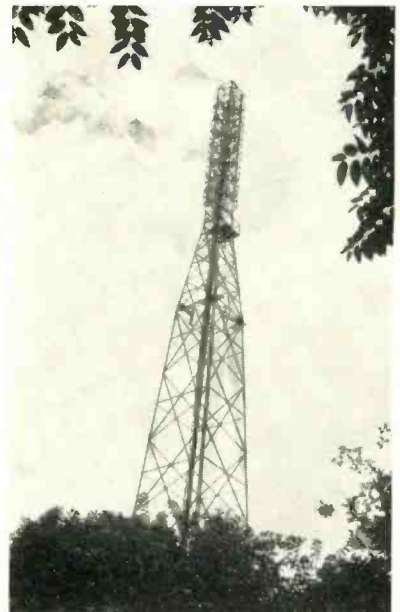

Eight-stack aerial array atop fabricated tower has gain of about sixfold in power when used by England's first commercial television broadcast station. It is located at Croydon and was built for Independent Television Authority by Marconi

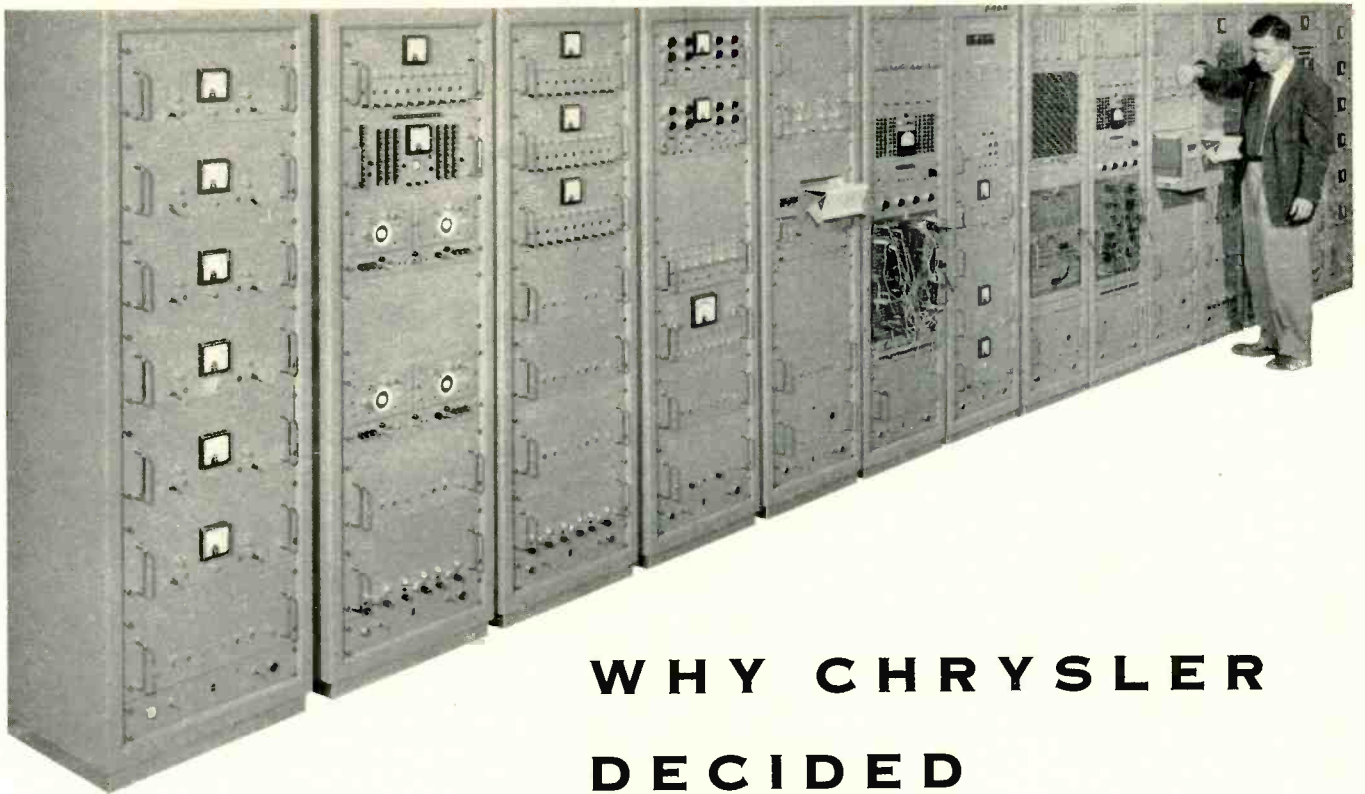

WHY CHRYSLER DECIDED TO "DO IT WITH EASE*"



Chrysler Corporation's guided missile research engineers wanted more than the ordinary analog computer's savings in solution time. They wanted faster set-up; rapid, simple computer programming and operation; automatic data recording, and high accuracy.

Chrysler and BERKELEY engineers worked together to develop an EASE* computer matched to Chrysler requirements and offering these outstanding features:

1. Automatic pushbutton setting of diode function generators, which permits set-up of their 12 non-linear functions in a matter of minutes rather than hours, and provides high accuracy with drift-free representation of the required function.
2. Automatic "hold" of computation at any two pre-set times, by means of an elapsed time clock and pre-set hold circuitry.
3. Digital display and readout of any selected variable on printed tape at the rate of one per second, to an accuracy of 1 part in 10,000.
4. Timing matrix which provides signals at any time "t" between 1 and 999 seconds, for programming control.
5. Remote operation and automatic scale factor indication of the recorder, controlled by the computer.

This is an excellent example of BERKELEY's ability to work closely with customers to develop computing and simulation equipment matched to specific requirements. Availability of BERKELEY's complete line of quality-computer components means early completion and substantial savings in costs. (Overall cost of the Chrysler EASE* computer was far lower than that of competitive equipment).

An eight-page brochure describing BERKELEY EASE* computers and components is yours for the asking; please address Dept. G11

66

Electronic
*EASE = Analog
(TM) Simulating
Equipment

Berkeley

division



BECKMAN INSTRUMENTS, INC.

2200 Wright Avenue • Richmond 3, California

for an entirely
new range of
time delays

Delay Intervals:

$\frac{1}{10}$ to 5
seconds

Recovery Rate:

extremely
rapid

specify
sturdy, dependable,
application-tested



G-V Hot Wire Time Delay Relays

SERIES H



WRITE for Publication No. 35—
complete engineering
data and drawings.

Designed for delay intervals which are longer than those produced by magnetic relays and shorter than can be produced by the usual types of thermal relays, these G-V Hot Wire Time Delay Relays make possible many simplified, lightened and improved designs.

How They Operate: G-V Series H Time Delay Relays employ a group of nickel-chromium alloy wires, 8 to 20 strands electrically in series and mechanically in parallel, as the actuating element. A mechanism holds these wires under tension and when the energizing current passes through these wires, heating them and causing elongation, the mechanism multiplies this and moves the contacts into or out of engagement.

Over two years of successful field service in electronic, aeronautical and industrial equipment prove these new G-V relays to be dependable, efficient and accurate.

ADJUSTABLE DELAY even though hermetically sealed DC or AC of any frequency for energization
SMALL AND LIGHT. $\frac{3}{4}$ " diameter, $2\frac{3}{8}$ " length. Weight: 1 oz.
WIDE AMBIENT RANGE compensated from -70°C to 100°C or higher
CONTINUOUS ENERGIZATION without damage
AVAILABLE in 7-pin Plug-in and Flanged designs

tion plates now are varied from plate to plate in a sequential manner, each plate varying gradually from B+ to approximately zero. The vertical deflection plates make the second bend and bring the beam into contact with the phosphor.

The two bends occur at right angles to each other. Focusing action in each bend may be likened to the collapsing of a copper pipe when bent sharply. The beam is squeezed in one dimension during each bend and since these bends are at right angles, the result is a small spot on the screen. Deflection defocusing is normally a problem in conventional tubes, as is beam blowup. This is a condition in which the charges within the beam tend to force the beam apart and therefore deteriorate focusing. They are of little hindrance in the new tube, as deflection defocusing is turned to advantage and beam blowup is of little consequence, owing to the fact that a dense beam is not created until the last convergence at the phosphor screen.

The display arrangement of the single-bend model results in a keystone-shaped display. This keystoning may be corrected by electronic, electrostatic or electromagnetic means. The two-bend model is not subject to keystoning.

Controlling Means

Each deflection plate varies between B+ and approximately zero in turn so the resultant negative field moves down the tube in a smooth manner. This action is reversible and can be used to create backward sweeps. There are many ways of accomplishing this voltage control, but only two will be described.

The simplest arrangement uses an electron gun, driven from the normal sawtooth voltage source, to sweep a row of target plates that are electrically connected to one set of deflection plates in the cathode-ray tube. The resistors serve to return the plates to B+ after the beam has passed. This setup will cause the voltage on each plate to be varied in a linear manner for sequential operation.

The desired result may also be accomplished by the use of a variable- μ or remote-cutoff grid in a tube



G-V CONTROLS INC.

24 Hollywood Plaza, East Orange, New Jersey

MICROWAVE SIGNAL GENERATORS AND SIGNAL SOURCES

*for extremely
high frequencies
12,400 to 50,000 mc*

Rugged, compact, completely integrated units. Designed to save engineering manhours in the laboratory and on the production line. Operate simply with direct-reading continuously variable dials. No calibration charts.

Frequency is measured by direct-reading reaction-type wave-meters that assure extreme accuracy. VSWR is exceptional—Signal Generators 1.7 to 1; Signal Sources 1.7 to 1 when attenuated. Calibration accuracy is given special attention.

Consult Polarad on all your EHF problems.

SG-1218

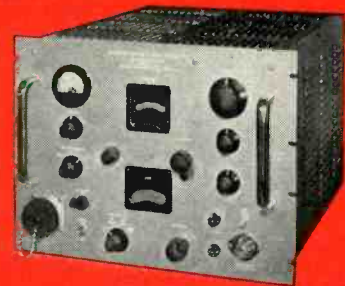

POLARAD MICROWAVE SIGNAL GENERATORS
12.4 TO 39.7 KMC

SS-1218

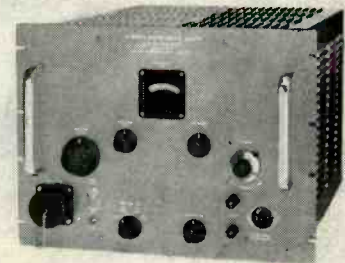

POLARAD MICROWAVE SIGNAL SOURCES
12.4 TO 50.0 KMC

Frequency Range	SIGNAL GENERATORS		SIGNAL SOURCES	
	Model Number	Output Power	Model Number	Power Output (Average)
12.4 to 17.5 KMC	SG 1218*	-10 DBM	SS 1218	15 mw
18.0 to 22.0 KMC	SG 1822	-10 DBM	SS 1822	10 mw
22.0 to 25.0 KMC	SG 2225	-10 DBM	SS 2225	10 mw
24.7 to 27.5 KMC	SG 2427	-10 DBM	SS 2427	10 mw
27.27 to 30.0 KMC	SG 2730	-10 DBM	SS 2730	10 mw
29.7 to 33.52 KMC	SG 3033	-10 DBM	SS 3033	10 mw
33.52 to 36.25 KMC	SG 3336	-10 DBM	SS 3336	9 mw
35.1 to 39.7 KMC	SG 3540	-10 DBM	SS 3540	5 mw
37.1 to 42.6 KMC	* External Source Power Measurement Range +10 to +30 DBM Accuracy with Correction: ±2 DB		SS 3742	Approx. 3 mw
41.7 to 50.0 KMC			SS 4150	Approx. 3 mw
Modulation: 1. Internal 1000 CPS Square Wave 2. External a. Pulse Pulse Width: 0.5 to 10 Microseconds PRF: 50 to 10,000 PPS Pulse Amplitude: 10 volts Pk to Pk Min. Polarity: Positive b. Sawtooth or Sinusoidal Frequency: 50 to 10,000 CPS Amplitude: 15 Volts RMS Min.				

SPECIAL FEATURES OF EHF SIGNAL GENERATORS

- Unique power measurement system employs waveguide components of unusual design — allows continuous and front panel monitoring.
- Attenuation is independent of power set and frequency.
- 1000 cycles cps square wave modulation and external fm or pulse modulation provided over entire frequency range.

For complete information write to your nearest Polarad representative or directly to the factory.



ELECTRONICS CORPORATION

43-20 34th STREET, LONG ISLAND CITY 1, N. Y.

AVAILABLE ON EQUIPMENT LEASE PLAN

**FIELD MAINTENANCE SERVICE AVAILABLE
THROUGHOUT THE COUNTRY**

REPRESENTATIVES • Albuquerque • Atlanta • Baltimore • Boston • Buffalo • Chicago • Dayton • Englewood • Fort Worth • Los Angeles • New York
Philadelphia • San Francisco • Syracuse • Washington, D. C. • Westbury • Winston-Salem • Canada, Arnprior, Toronto—Export: Rocke International Corporation

Kearfott

TESTING EQUIPMENT STANDARD AND CUSTOM MICROWAVE COMPONENTS



UNIVERSAL TEST SETS FOR X, K_u, and C BANDS

Combined in one unit are means to measure power—a spectrum analyzer—a unit to measure frequency, and a signal generator.

Each test section is modular in construction, with separate plug-in chassis. Available for X, K_u, and C Bands.



STANDARD microwave equipment for laboratory or production includes attenuators, directional couplers, crystal mixers, wave meters and other components. Units are available for S, C, X_u, X and K_u Microwave Bands in aluminum or brass.

CUSTOM-DESIGNED Microwave equipment is a Kearfott specialty. Skillful engineering, wide experience, with complete laboratory testing facilities can be brought to bear on your problem. Kearfott can supply special components such as rotary joints, R.F. sources and matched assemblies.

NEW FERRITE ISOLATOR... a useful device with many applications, such as oscillator isolation. This light-weight unit (less than 2 lbs.) improves system performance by reducing long-line loading. It also prevents undesired frequency shift, insures uniform power output with improved transmitted pulse spectrum.

FERRITE Resonance Absorption Transverse Field Isolator for use where high power handling capacity is required. Over a 10% band width this unit has... greater than 9 db isolation, less than 0.4 db insertion loss and VSWR less than 1.03.



FERRITE ISOLATOR *PATENTED
MODEL 152-1A

FERRITE HI-POWER
MODEL 154-1A

Electronic Chopper for D-C Amplifiers

By IRVING BARDITCH
Baltimore, Md.

COMMERCIALY AVAILABLE vibrator-type choppers have voltage limitations depending both upon their contact material and physical con-

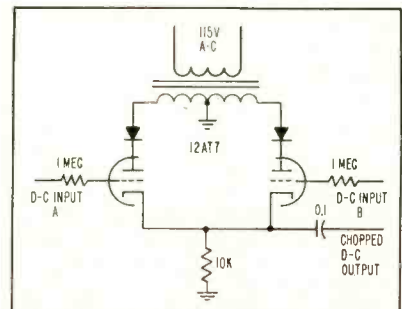

Vacuum-tube d-c chopper is useful at high voltages where arcing may reduce life of vibrator type units

Write today for complete technical bulletins.

Kearfott

COMPANY, INC.
LITTLE FALLS, NEW JERSEY
WESTERN MANUFACTURING DIVISION
14844 OXNARD ST. • VAN NUYS, CALIF.

A SUBSIDIARY OF
GENERAL PRECISION
EQUIPMENT
CORPORATION



Eastern Office:
1378 Main Ave.
Clifton, N.J.

Midwest Office:
188 W. Randolph St.
Chicago, Ill.

South Central
Office:
6115 Denton Drive
Dallas, Texas

Western Area
Office:
253 Vinedo Ave.
Pasadena, Calif.

SALES OFFICES



RMC
1500

for Outstanding Uniformity and Stability



RMC
800

specify **RMC type JL DISCAPS**



RMC
330

If your applications require a capacitor with uniform characteristics and exceptional stability over an extended temperature range, Type JL DISCAPS will provide the best answer. Control of production processes from basic powders to completed DISCAP is your assurance of absolute uniform quality.

Maximum capacity change between -60°C and $+110^{\circ}$ is only $\pm 7.5\%$ of capacity at 25°C . Type JL DISCAPS with a standard working voltage of 1000 V.D.C. are manufactured in capacities between 220 MMF and 5000 MMF.



RMC
2000

Plug-in Leads

Type JL DISCAPS as well as temperature compensating, and by-pass types are manufactured with plug-in leads for printed circuit applications. Leads are No. 20 tinned copper (.032 diameter) and are available up to $1\frac{1}{2}$ " in length. Plug-in DISCAPS will provide worthwhile savings on printed circuit assemblies.



RMC
5000



RMC
3900

Write today on your company letterhead for expert engineering help on any capacitor problem.

DISCAP
CERAMIC
CAPACITORS



RMC

RADIO MATERIALS CORPORATION
GENERAL OFFICE: 3325 N. California Ave., Chicago-18, Ill.

FACTORIES AT CHICAGO, ILL. AND ATTICA, IND.
Two RMC Plants Devoted Exclusively to Ceramic Capacitors

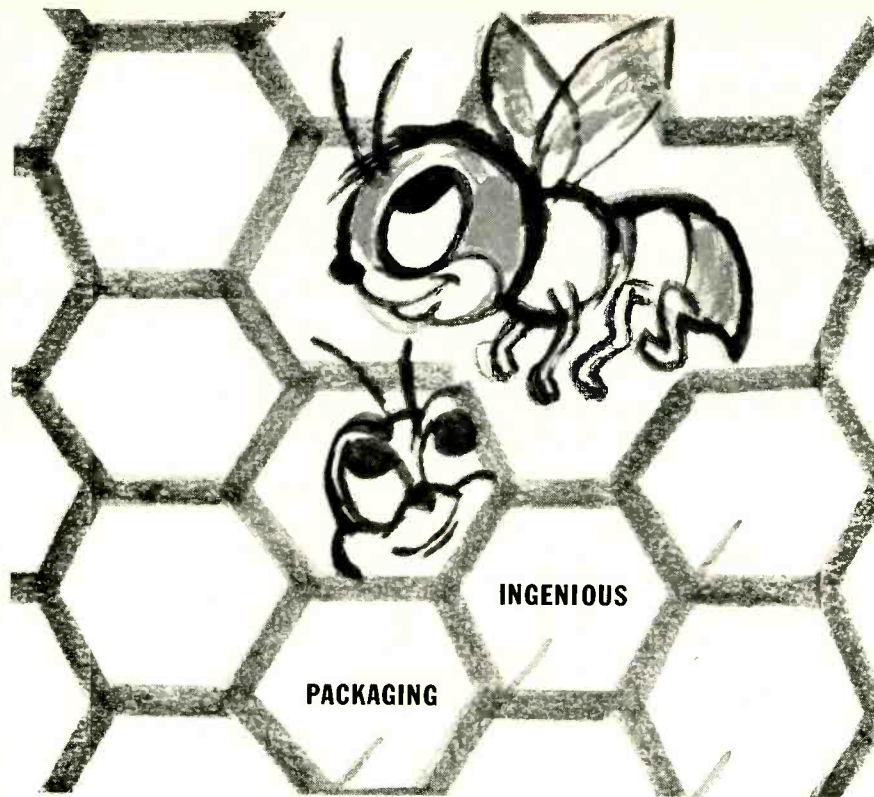

The most advanced developments in electronics are being made in the sphere of airborne radar and related ground control systems because of military emphasis. Further applications of electromechanical techniques in these fields are creating new openings in the Systems Division of Hughes Research and Development Laboratories.

Engineers who have demonstrated ingenuity and inventive ability will find interest in areas of work that call for devising reliable, maintainable, manufacturable designs for precision equipment developed at Hughes Research and Development Laboratories.

The design of this equipment, manufactured at Hughes, involves mechanical, electromechanical, electronic, microwave and computing problems. Design also requires the use of such advanced techniques as subminiaturization, unitized "plug-in" construction, with emphasis on design for volume production. Knowledge of electronic components, materials, finishes and military specifications is useful.

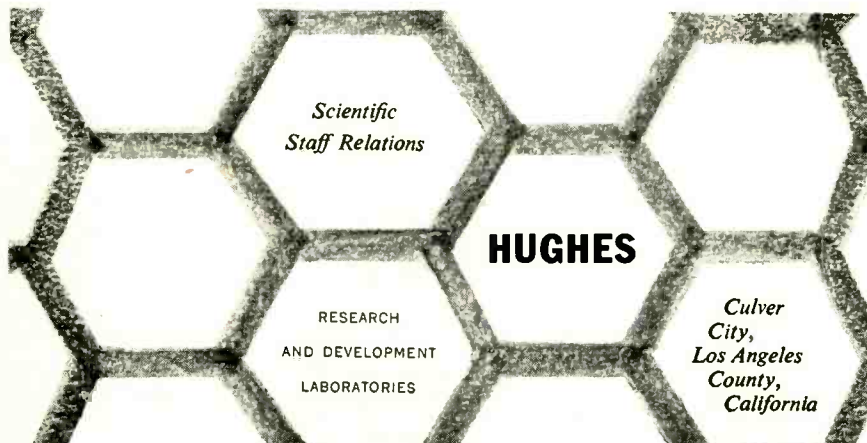

struction. In applications where d-c potentials of greater than 300 volts must be converted to a-c voltages, their use is not indicated.

A simple vacuum-tube circuit of good stability and long life can be used. This circuit consists of two triodes connected as cathode followers with a common cathode being fed alternate half waves of the chopping frequency through selenium rectifiers to their respective plates. The unit exhibits in large measure cathode-follower stability, while the series grid resistors limit loading on the d-c sources.

The transformer center tap and the cathode resistor may be returned to either ground or positive and negative potentials respectively to allow both positive and negative inputs to the grids.

Nonlinear Time-Delay Generator Uses Diodes

By BRUCE A. KAUFMAN
Frankford Arsenal
Philadelphia, Pa.

A DELAYED TRIGGER can be produced whose delay from the initiating trigger is proportional to a known nonlinear function of the height of a control pedestal containing system information. In addition, this pedestal varies in amplitude throughout its duration and the delay must be determined by its height at the instant of initiating trigger.

These requirements were met by a time-delay generator of the phantastron type. In a phantastron,

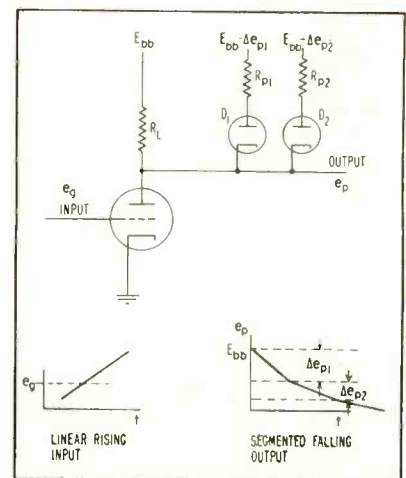

FIG. 1—Nonlinear function generator uses biased diodes to shape waveform

Now...HIGH CONDUCTANCE GERMANIUM DIODES



by HUGHES

A series of new High Forward Conductance types has been added to the comprehensive line of Hughes subminiature germanium point-contact diodes. The sturdy internal construction of these point-contact devices ensures electrical and mechanical stability—even under severe operating conditions.

With the addition of this new series, Hughes now offers an even greater selection of RETMA, JAN, and Special diode types, embracing the complete range of germanium diode specifications. This means that you can be sure of obtaining the particular Hughes diode best suited to meet the specific requirements of your circuit. That's because you can choose from among varying combinations of such electrical characteristics as: High Conductance . . . High Back Resistance . . . Quick Recovery . . . High Temperature Operation.

Listed here are a few of the more popular Hughes diode types, arranged according to forward and reverse characteristics. More than 150 additional special types are available.

At Hughes, intensive research is devoted to the continuing development of existing products. This effort progressively provides you with the finest semiconductor devices available. It is one reason why Hughes diodes are *first of all* . . . for RELIABILITY. It's one more reason why you should come to Hughes for your diode requirements!

	WORKING INVERSE VOLTAGE	FORWARD CURRENT at +1V (Milliamperes)							
		3-5	5	10	20	50	100	150	200
30	200 μ A @ - 20V						HD 2152		
40	10 μ A @ - 10V	1N128*							
60	50 μ A @ - 50V		1N116	1N117	1N118	HD 2167	HD 2173		HD 2160
	100 μ A @ - 50V		1N90	1N95	1N96	HD 2166	HD 2174		HD 2171
	500 μ A @ - 50V					HD 2155	HD 2162		HD 2172
	850 μ A @ - 50V		1N126*						
80	50 μ A @ - 50V	1N67A		1N99	1N100	HD 2151	HD 2150		HD 2158
	100 μ A @ - 50V	1N89		1N97	1N98	HD 2165	HD 2163		HD 2157
	125 μ A @ - 50V**		1N191**						
	250 μ A @ - 50V**		1N192**						
	500 μ A @ - 50V		1N198*			HD 2169	HD 2175		HD 2159
100	180 μ A @ - 90V							HD 2154	
	500 μ A @ - 100V					HD 2170	HD 2165		HD 2161
	825 μ A @ - 100V	1N68A							
	300 μ A @ - 50V	1N127*							
50 μ A @ - 50V	HD 2051								
150	500 μ A @ - 150V		1N55B						

*JAN Types. 1N198 only high-temperature tested at 75°C.

**Computer Types. Special recovery tests. 1N191 and 1N192 tested for back current at 55°C.

New High Conductance types listed in red.

Like all Hughes diodes, High Forward Conductance types are packaged in the famous one-piece, fusion-sealed glass envelope, impervious to moisture and to external contamination. Maximum dimensions, glass envelope: Length: 0.265 inch. Diameter: 0.105 inch.

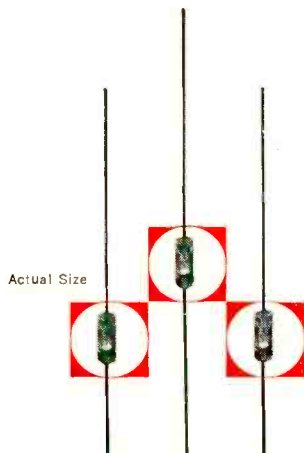

HUGHES

Aircraft Company, Culver City, California

SEMICONDUCTOR DIVISION

New York Chicago
Los Angeles



"WOW!
I hope we
got a record
of THAT...!"

COSTLY DESTRUCTION TESTS DEMAND THE RELIABILITY OF A FAIRCHILD OSCILLO-RECORD CAMERA

Of course, you can always get another piece of equipment to test, set up your instruments, repair your personnel, relandscape the grounds and start all over . . . but it's really easier and less expensive to get the data the first time. Barring a cataclysm like the one above, the Fairchild Oscillo-Record Camera is your best bet for getting accurate records of the test data you want . . . the first time.

Since Fairchild built the first camera specifically designed for oscilloscope recording, more *Oscillo-Record* cameras have been used than all other continuous motion oscilloscope recording cameras combined. The *Oscillo-Record* camera has several design features which contribute to its outstanding reliability and trouble-free operation in obtaining accurate test data. It is ruggedly constructed; its sprocket film drive eliminates slippage, even at high speeds. Rigid, top-of-scope mounting safeguards it against accidental upsetting, maintains the camera in focus at all times and leaves oscilloscope controls unobstructed. Other features include the electronically-controlled continuously variable film speed which permits the selection of the exact rate of film transport for optimum performance.

For any wave pattern . . . continuously varying, stationary or single transient, at all speeds from 1 to 3600 inches per minute, (7200 in/min on special order) the Fairchild Oscillo-Record camera is the reliable means of photographing scope patterns. Industrial Camera Division, Fairchild Camera & Instrument Corp., 88-06 Van Wyck Expressway, Jamaica, L. I., N. Y., Dept. 120-25A.

FAIRCHILD

OSCILLOSCOPE RECORDING CAMERAS

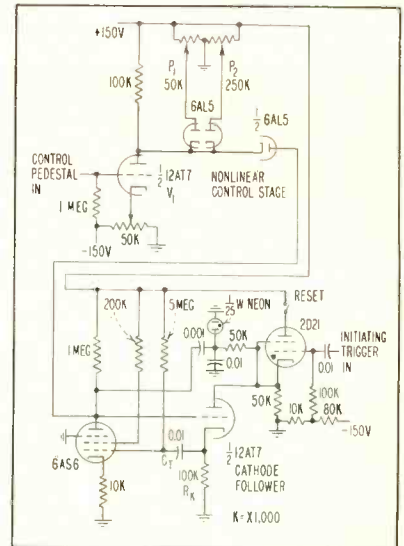

FIG. 2—Time-delay generator produces pulse delayed in time as a function of nonlinear waveform generated by V_1 .

plate-rundown and hence screen pulse duration is a highly linear function of the plate-control voltage existing at trigger and is independent of it afterwards. The trailing edge of this screen waveform may be differentiated to produce a spike delayed in time from that which triggers the phantastron.

To produce a delay that is the given nonlinear function of the pedestal magnitude, a special stage was provided to feed the pedestal to the phantastron. This stage shown in Fig. 1 is essentially a nonlinear d-c amplifier, whose output is a requisite function of input voltage.

As the input voltage rises the plate voltage falls and when it falls a given increment Δe_p , diode D_1 con-

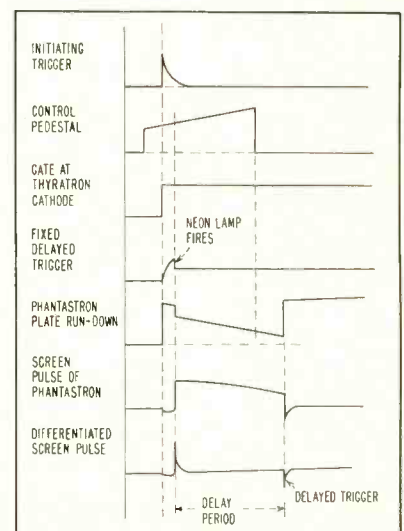
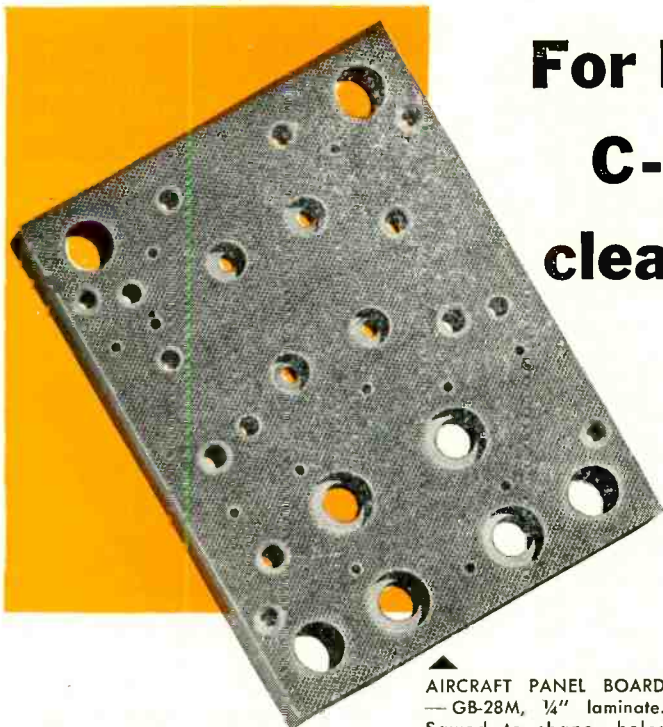
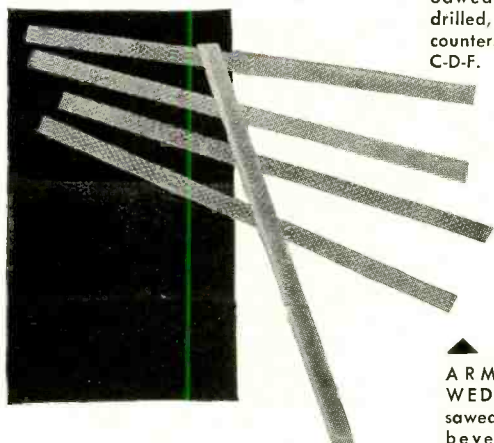

FIG. 3—Waveforms at various points in nonlinear time delay generator circuit

For high heat applications C-D-F Melamine Dilecto cleanly machined by C-D-F



▲ AIRCRAFT PANEL BOARD — GB-28M, 1/4" laminate. Sawed to shape, holes drilled, counterbored and countersunk. Machined by C-D-F.



▲ ARMATURE SLOT WEDGES — GB-28M, sawed into strips, then beveled edges were broached to angle of 21° 23', and strips were cut to exact length. Machined by C-D-F.



◀ RF COIL FORM — Natural GB-112M Dilecto rolled tubing, smooth edged. Sawed to length; drilled and burred by C-D-F.

▼ TERMINAL BLOCK — GB-28M. Sawed to shape, grooves milled, corners sanded round. Holes were drilled, counterbored, characters stamped. Machined by C-D-F.

▶ INSULATOR — ML rod. Turned on automatic screw machine by C-D-F. Grade ML is a fine weave cotton fabric base laminate bonded with a melamine resin. Easy to machine.

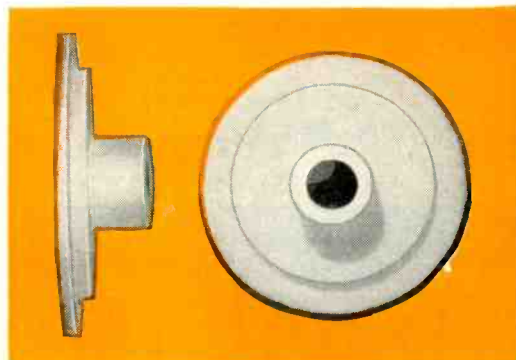
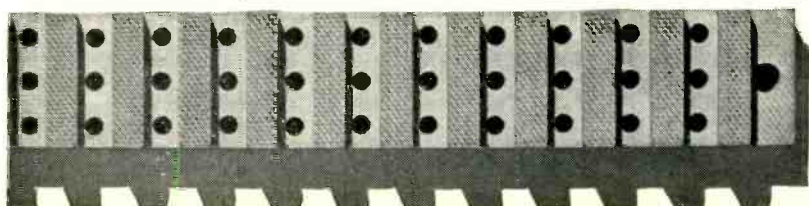

As operating temperatures rise, melamine laminated plastics can satisfy many requirements for component parts. Glass base melamine grades of Dilecto resist elevated temperatures — up to 300° F. continuously, 350° F. intermittently. They have extremely high impact strength; excellent arc resistance and self-extinguishing properties. C-D-F melamine Dilecto grades are usually specified for many electrical applications requiring high arc resistance, mechanical strength, flame and heat resistance.

C-D-F can supply melamine Dilecto in sheets, tubes and rods in the following grades:

GB-28M—Medium weight glass base laminate with melamine resin. Highest mechanical strength; excellent arc resistance, high heat and flame resistance; self-extinguishing. Dimensionally stable—little affected by temperature and humidity.

GB-112M—Lightweight glass fabric with melamine resin. Substantially same characteristics as GB-28M. Usually produced in thickness less than 1/32".

GM-1—Glass mat base melamine resin bonded laminate. A lower cost product suitable for many applications requiring arc resistance along with good mechanical strength and flame resistance.

USE COMPLETE MANUFACTURING FACILITIES OF C-D-F. Make us responsible for your complete job . . . from laminates to finish machining of components. C-D-F has the know-how to cleanly machine melamine Dilecto to close tolerances. C-D-F can save you time, money and waste of material. And when you make C-D-F responsible for the complete job, you know what you're getting: components machined to exact specifications; strict adherence to quoted prices; and prompt delivery.

Write for samples and technical bulletins on melamine Dilecto components. Call in a C-D-F sales engineer, tell him your problem. He'll help you.

See our general catalog in Sweet's Design File for more data, the address and telephone number of your nearest C-D-F sales engineer. Also write for technical bulletin and specific catalog, free test samples, or send us your print for quotation.



Continental-Diamond Fibre

CONTINENTAL-DIAMOND FIBRE DIVISION OF THE BUDD COMPANY, INC.
NEWARK 16, DELAWARE

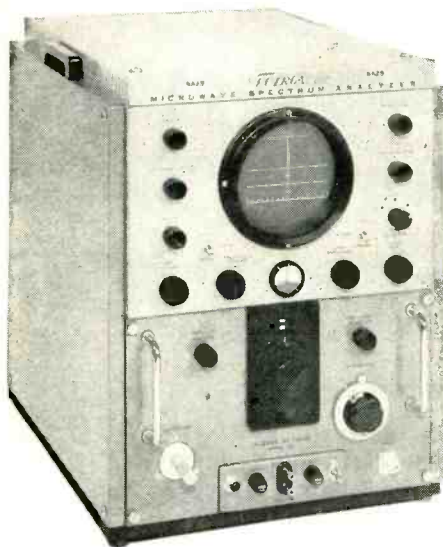

MICROWAVE SPECTRUM ANALYZER

Model SA25

800 mc/s to 10,250 mc/s
on fundamentals
K-Band coverage
to 40,000 megacycles

Plus these features . . .

- Frequency accuracy to 0.05%
- Stable low noise 20 kc bandwidth double conversion IF amplifier
- Amplified transmission wavemeters
- Improved power-response display
- Choice of 2-20 or 6-60 cps sweep
- Fully regulated power supplies
- Simple, reliable, proven circuitry

Write for descriptive Bulletin SA25



VARIABLE FREQUENCY POWER SUPPLY

Model VFS-250

For testing electronic
and electrical equipment
For powering vibrators
and choppers
For controlling synchronous
motors

Check these features . . .

- Output power to 300 volt amps
- Output frequency 45-2000 cy
- Output voltage 0 to 135 v. a. c.
- Regulation — No load to full load 1%
105 v to 125 v line 1%
- Full negative feedback for instantaneous control
- Compact, accessible bench top unit
fits within standard rack

Write for descriptive Bulletin VFS-250



 **VECTRON, inc.**

1609 TRAPELO ROAD • WALTHAM 54, MASS.

VECTRON FOR DESIGN AND MANUFACTURE OF:

Gyros and Gyro Systems
Gyro Stabilized Platforms
Servo and Gyromechanisms
Aircraft Instruments

Precision Mechanical Devices
Computers and Calculators
Special Gears and Assemblies
Synchros and Control Motors

ducts shunting R_{p1} across R_L and reduces the gain of the stage. As the plate voltage continues to fall, D_2 will conduct and further reduce the gain of the stage in a like manner. A segmented voltage transfer characteristic is thus obtained.

The diode switched load resistors and Δe_p can be varied to produce a variety of control functions. Any number of diodes and shunting resistors may be used to obtain the desired degree of approximation to a given function.

When the control pedestal, which is positive-going, appears at the

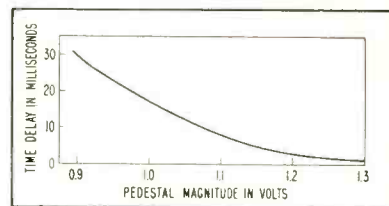

FIG. 4—Time delay as a function of pedestal magnitude

grid of the control tube, a negative-going pedestal of controlled amplitude appears at the plate.

At some instant during the duration of the control pedestal a trigger is supplied to the phantastron, which must then generate another trigger, delayed in time by an amount directly proportional to the voltage level existing at the plate of the control tube at the instant of trigger. Since the pedestal has been passed through the control stage whose output is the requisite function of its input, the desired time-delay versus pedestal magnitude is obtained.

Since a phantastron will trigger on a negative pulse applied to the plate or grid, the leading edge of the control pedestal will trigger the phantastron and all control is lost. Means for preventing this action must be provided. A successful scheme used here was to return the plate of the cathode follower of the phantastron circuit to the cathode of a thyatron. Feedback action of the phantastron is prevented until the cathode follower is gated on. The thyatron is fired by the same trigger that starts the phantastron. However, this results in a system limitation. Owing to the finite time necessary to charge C_T to the increased cathode voltage of the gated

10 Waldes Truarc rings speed assembly— Eliminate parts and machining in precision control



Kahn Rotary Speed Control

Kahn and Company, Inc., of Hartford, Conn., use a total of 10 Waldes Truarc Retaining Rings in this new mechanical-electric translator for automatic control of rotary speed. Truarc rings act as positioners and retainers to eliminate parts, simplify operations, save labor, and speed assembly.

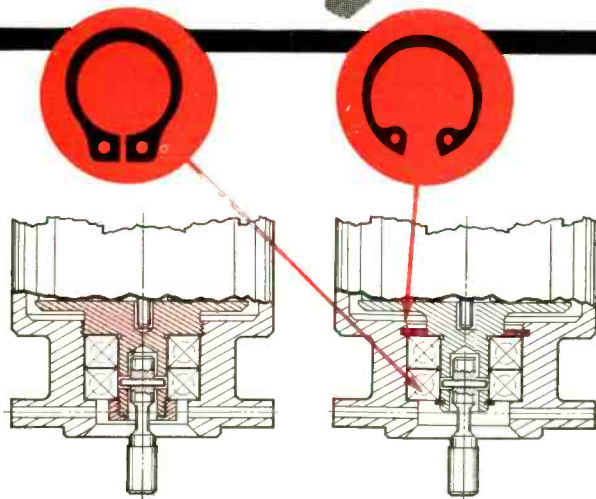

Rotor Installation. In the old way, ball bearing was retained by a threaded shoulder and threaded bearing cup retainer.

New way, using two Truarc Rings (Series 5100 and 5000) eliminates 4 threading operations, bearing shoulder and threaded bearing cup. Assembly is quicker and easier, two ounces lighter.

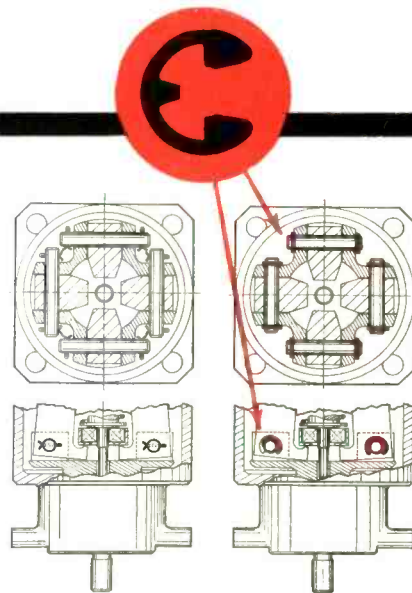

Flyweight Assembly. Formerly, 2 holes had to be drilled in each of the 4 pivots, and 8 cotter pins were required.

The new way, using 8 Truarc E-Rings (Series 5133), replaces holes with grooves, reduces pivot size, leaves no projecting parts. Rings snap into place, speed assembly time by three minutes per unit.

Whatever you make, there's a Waldes Truarc Retaining Ring designed to improve your product... to save you material, machining and labor costs. They're quick and easy to assemble and disassemble, and they do a better job of holding parts together. Truarc rings are precision engineered and precision made, quality controlled from raw material to finished ring. **36 functionally different types...** as many as 97 different

sizes within a type... 5 metal specifications and 14 different finishes. Truarc rings are available from 90 stocking points throughout the U. S. A. and Canada.

More than 30 engineering-minded factory representatives and 700 field men are available to you on call. Send us your blueprints today... let our Truarc engineers help you solve design, assembly and production problems... without obligation.

For precision internal grooving and undercutting... Waldes Truarc Grooving Tool!

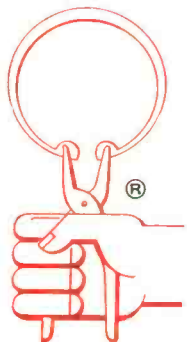

Send for new catalog supplement

WALDES TRUARC®

RETAINING RINGS

Waldes Kohinoor, Inc., 47-16 Austel Place, L. I. C. T., N. Y.
Please send the new supplement No. 1 which brings Truarc Catalog RR 9-52 up to date.
(Please print)

Name.....
Title.....
Company.....
Business Address.....
City.....Zone.....State.....

E117

WALDES TRUARC Retaining Rings, Grooving Tools, Pliers, Applicators and Dispensers are protected by one or more of the following U. S. Patents: 2,382,948; 2,411,426; 2,411,761; 2,416,852; 2,420,921; 2,428,341; 2,439,785; 2,441,846; 2,455,165; 2,483,379; 2,483,380; 2,483,383; 2,487,802; 2,487,803; 2,491,306; 2,491,310; 2,509,081; 2,544,631; 2,546,616; 2,547,263; 2,558,704; 2,574,034; 2,577,319; 2,595,787, and other U. S. Patents pending. Equal patent protection established in foreign countries.

NEW

MINIATURE

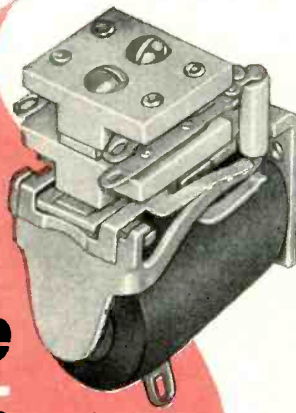
**Low Capacitance
SWITCHING
RELAY**

TYPE MLC



Low Capacity Blades
For
**HIGH FREQUENCY
SWITCHING**
SWITCHES MOUNTED
ON
CERAMIC SEPARATORS

Capacitance (with 1 Form "A" switch):
Capacitance between open contacts .75 mmfd;
Capacitance between closed contacts 2.0 mmfd;
Capacitance from contact to ground 1.25 mmfd.

Coil Resistance: Up to 6500 ohms (No. 44 AWG wire).

Contact Rating: 3 amps. @ 28 VDC max. Suitable for low level audio or r.f. loads. Contact material dependent on application.

Contact Combination: Standard, up to 1 Form "C".

Shock: Meets requirements of MIL-R-5757B.

Vibration: 10G up to 500 CPS.

Size: $2\frac{3}{32}$ " wide, $1\frac{1}{32}$ " long, $1\frac{1}{16}$ " high with 1 Form C.

Applications: For guided missiles, h.f. communications equipment, etc.

AVAILABLE
CUSTOM-
MANUFACTURED
TO EXACTLY
FIT YOUR NEEDS

SEND FOR
DETAILS
NOW



Comar
ELECTRIC COMPANY
3349 ADDISON STREET
CHICAGO 18, ILLINOIS

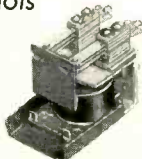
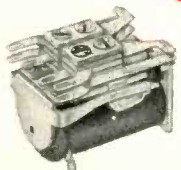

RELAYS • SOLENOIDS • COILS • TRANSFORMERS • SWITCHES • HERMETIC SEALING

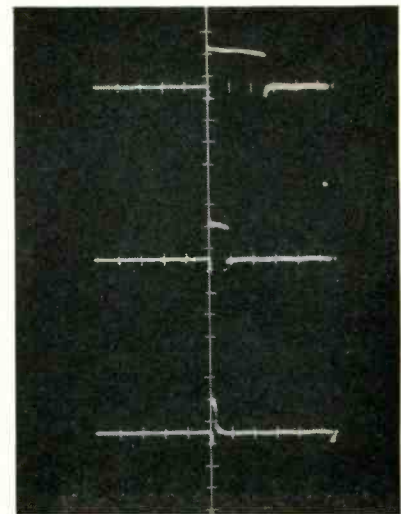

FIG. 5—Waveforms at screen of phantastron

cathode follower, the phantastron is not ready to start until about $R_c C_T$ seconds after the gate. The phantastron must be supplied with a trigger delayed at least $R_c C_T$ seconds from the initial starting trigger.

Since this time is not highly critical, a simple RC neon-lamp fixed-delay generator is provided. It is initiated by the positive step at the cathode of the thyatron. Theoretically speaking, if the level of the control pedestal varies significantly during this trigger delay period a system error results.

For the particular system under consideration the time rate of change of level is not so great as to cause this source of error to be

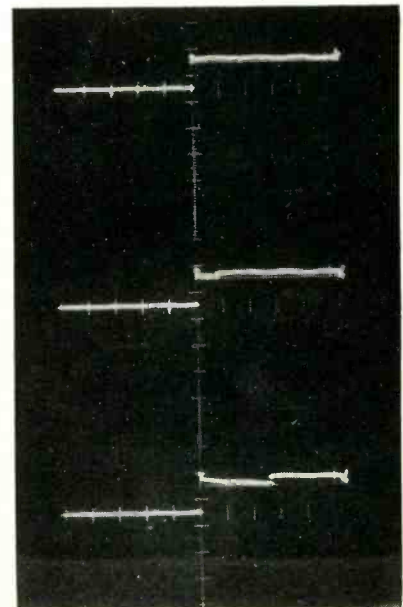

FIG. 6—Phantastron plate waveforms

L&N Precision Stabilized Power Supplies guard instrument accuracy against line voltage fluctuations

• Leeds & Northrup has developed two types of power supplies to meet the precision requirements of our own instruments such as the Recording Spectrometer, the Electro-Chemograph® and the Infrared Gas Analyzer. These power supplies have been so successful that we are now making them available for general use.

For Multiplier Phototubes and Similar High Voltage Applications

Two Independent Output Voltage Sources — Ranges

(1) 500 to 1310 volts d-c across 1 megohm load. Continuously adjustable with coarse and fine dials. (1; see fig.)

(2) 480 to 790 volts d-c across 1 megohm load. Continuously adjustable with 12-position coarse dial only. (2; see fig.)

Line Voltage Tolerance—0.01% d-c output change for a change in a-c line voltage from 100 to 125 volts.

Drift—Not more than 0.01% for a period of 8 hours or more, after a 20-minute warmup.

Ripple—Considerably less than 30 millivolts rms.

Time Delay Relay Circuit—30 second time delay allows tube heaters to come to proper operating temperature before high voltage is applied. (3; see fig.)

Size—19" x 10 1/2" x 10", for relay rack mounting.

Catalog Number—101038

Price—\$715.00 F.O.B. Phila.; subject to change without notice.

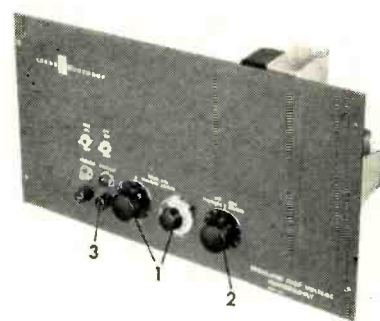

For General Purpose Laboratory Applications

Output Voltage Range—105 to 125 volts d-c, continuously adjustable.

Current Range—0-200 ma at 105 volts.

Stability—0.05% d-c output change for a change in a-c line voltage from 105 to 125 volts.

Drift—No greater than 0.05% in 24 hours.

Load Current Regulation—At 105 volts output, load change from 0 to 200 ma produces a 0.05% change in output voltage.

Ripple—Less than 5 millivolts rms.

Size—9 1/8" x 13 3/8" x 9 7/8", with metal case.

Catalog Number—101-2-0-2

Price—\$276.00 F.O.B. Phila., subject to change without notice.

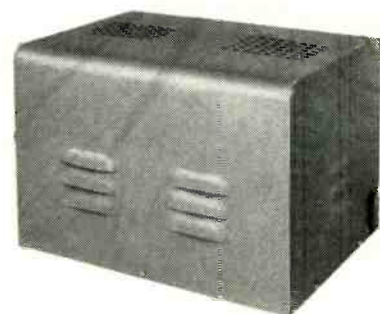

Catalog Number—101-2-0-1, same as above except includes chassis only without metal case and has a constant voltage output of 105 volts.

Price—\$203.00 F.O.B. Phila., subject to change without notice.

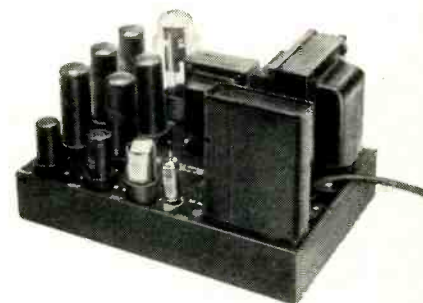

Order through our nearest district office, or directly from . . .

LEEDS & NORTHRUP COMPANY
4979 Stenton Ave., Phila. 44, Pa.



SPECIALIZED SERVICE

..... keeps your Ace enclosure on the job!

Put it up . . . take it down . . . air condition it . . . make it larger—or smaller! Whatever the future demands of your Ace shielded enclosure, *you'll be prepared.* Years from now you'll still benefit from the same sound advice and counsel offered by Ace engineers in the original design of your enclosure. Why? Because Ace—and only Ace—stands behind the service of your enclosure, as well as the performance.

Little wonder, then, that laboratories, hospitals, manufacturers of every description, and the military prefer Ace. *It's the one enclosure you can buy today for tomorrow's needs.* Whether you're interested in an entirely new enclosure or modification of your present installation, you'll find it pays to call on Ace.

Detailed information on the complete line of Ace enclosures—featuring highest attenuation, full interchangeability*, inside bolting* . . . and exceeding the performance requirements of MIL-S-4957 (ASG)—is given in Bulletin 10 available on letterhead request.

(*Patents Pending)

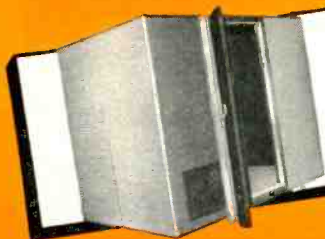

As an additional feature Ace can now supply shielded enclosures with microwave absorber to simulate free space—or can modify existing installations for microwave testing.

ACE ENGINEERING & MACHINE COMPANY
3644 North Lawrence Street • Philadelphia 40, Pennsylvania

required delay versus pedestal magnitude. Figures 5 and 6 also show typical waveforms at the screen and plate of the phantatron.

Precise Measurement of Sawtooth Linearity

By ROBERT L. RICHARDSON
Syracuse University
Syracuse, N. Y.

IN MANY CIRCUIT applications a linear sawtooth waveform of voltage is required. Frequently a departure from perfect linearity of less than ± 0.5 percent is necessary. There are circuits capable of generating waveforms of this sort but some way of measuring their departure from linearity is usually needed. One way of making these measurements is presented here.

The linearity of the waveform is determined by measuring its amplitude at many closely spaced points. Using these measurements the waveform may be plotted. This plot is then compared to a perfectly linear sawtooth to determine its departure from linearity. The problem is therefore to measure precisely the ordinates and abscissas of a large number of points along the waveform so that an accurate plot may be obtained. The circuit of Fig. 1 is used to perform these functions.

The operation of this circuit is as follows. The sawtooth voltage is applied to the input terminals. The waveform at the grid of V_1 is a sawtooth whose d-c level can be varied by changing the bias voltage. This grid voltage is amplified

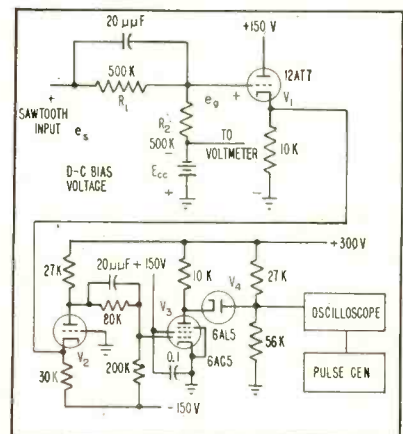

FIG. 1—Circuit for measuring linearity of sawtooth waveforms

TAYLOR

Laminated Plastics
Vulcanized Fibre

Shop Talk

TAYLOR FIBRE CO.

Plants in Norristown, Pa. and La Verne, Calif.

PHENOL—MELAMINE—SILICONE—EPOXY LAMINATES • COMBINATION LAMINATES • VULCANIZED FIBRE • POLYESTER GLASS ROD

Tips for designers



Terminal board for a complex circuit in an electronic spectrophotometer instrument is made of Taylor Grade LE laminate . . . selected for its insulating and mechanical properties.

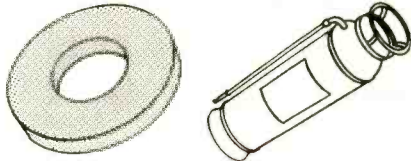

Washers for fire extinguishers are punched from Taylor Vulcanized Fibre . . . a versatile material that resists many chemicals, provides a long-wearing seal.

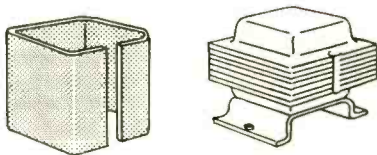

Inter-winding insulation for transformers is an application for Taylor Insulation (Fish Paper) . . . a tough, economical material that resists abrasion, withstands high voltages.

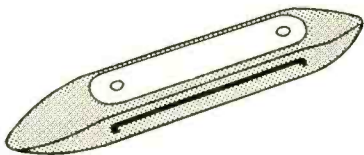

Textile shuttles are faced with Taylor shuttle fibre, which machines to a smooth, long-wearing surface that doesn't snag yarn in high-speed machines.

TAYLOR FABRICATING FACILITIES

Your production problems can often be simplified . . . schedules safeguarded . . . inventory headaches cured . . . and overall costs reduced by having Taylor fabricate finished parts of vulcanized fibre and laminates to your specifications. Efficient, modern facilities are ready to serve you. Write to Taylor about your specific requirements.

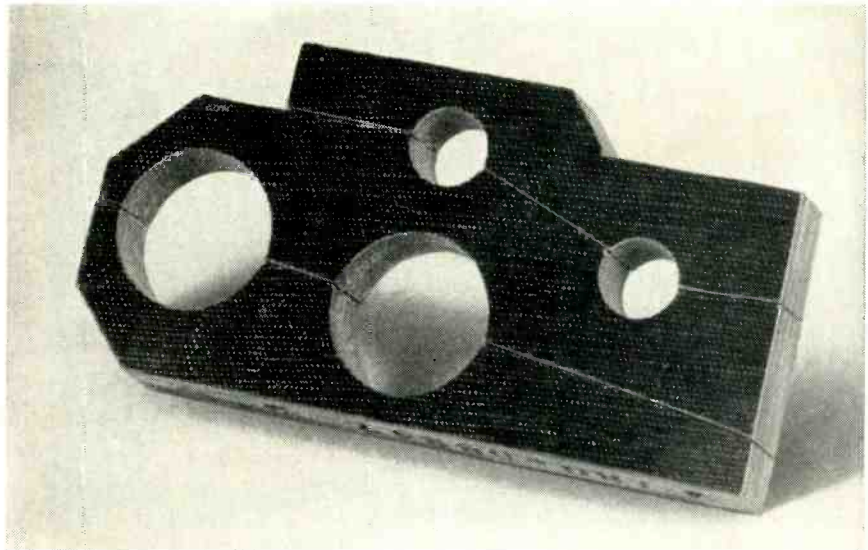

Multiple fuel line clamp, for use in the North American F-86 Sabrejet fighter plane, is made of Taylor fabric base laminate . . . chosen for its mechanical strength, light weight and resistance to extremes of temperature and humidity.

Strength and machinability highlight Taylor fabric base laminates

Does your product design call for a material with high strength, light weight, stability, electrical resistance and electrical insulation qualities . . . plus good machinability?

Consider what Taylor fabric base phenol laminates can do for you. This family of versatile materials covers a broad range of mechanical, electrical and machining properties, from which you'll probably find the exact combination that fits your requirements. The fabric base may be cotton—in various weights and weaves—asbestos, glass or nylon fibre, bonded by selected high grade Taylor resins.

Need mechanical strength? Choose Grade C for toughness, resilience, resistance to impact and fatigue . . . or Grade L for comparable qualities with better machined edges.

Need electrical insulation? Grade CE combines mechanical strength with good electrical insulation properties . . . Grade LE for somewhat higher stability and insulating value . . . and Grade CEF offers a finer

machined appearance with good impact and electrical strength.

Need dimensional stability? Grades CE-6 and LE-6 combine many C and L qualities with greater dimensional stability . . . particularly valuable in close tolerance work.

Need to deep-draw? Grade C-7 is made with a special fabric designed for post-forming qualities . . . draws and stretches during forming into complex shapes.

High temperatures? Grade AA asbestos base, and Grade G-3 glass fabric base give you a choice of materials that stand up at elevated temperatures.

These and other Taylor fabric base phenol laminates can serve you well, by putting extra performance values into the products you manufacture, and by providing economical machining in your production line. For complete details, write for a copy of Taylor's general catalog. And ask a Taylor specialist to consult on your specific materials application problem.

FROM LM ELECTRONICS . . .

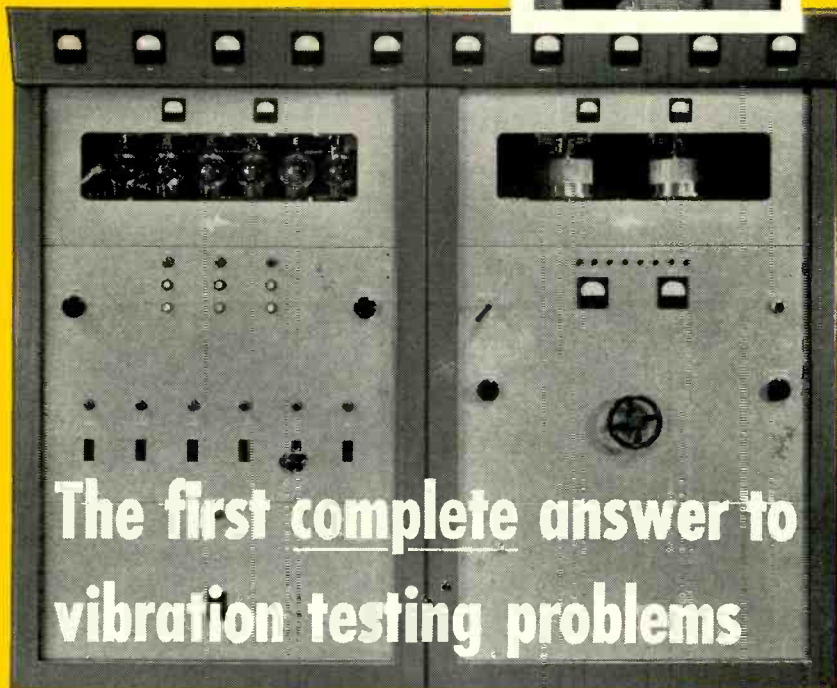

Pictured above is the 30,000 watt electronic power supply unit—heart of the LM vibration test system. Top inset photo shows the operating console.

The first complete answer to vibration testing problems

Here is LM's newest complex wave vibration test system . . . an integrated equipment "package" that offers unmatched operating flexibility in a variety of applications. Engineered by electronic design specialists, LM vibration test systems and matching electronic power supplies are offered in 12 sizes, with outputs ranging from 250 to 125,000 watts . . . ample power to drive shakers up to 12,500 force-pounds. Built to exacting performance standards, these completely integrated systems offer simplicity of operation, accuracy and reliability over a wide range of operating conditions.

ACCURATE DUPLICATION OF ANY FREQUENCY SPECTRUM . . .

LM's complex wave vibration test systems produce—from a voltage input signal—acceleration on a mechanical part at the shaker table. This acceleration has a frequency spectrum whose distribution is identical to that of the input signal, permitting exact, electronically-controlled test conditions to which the mechanical part may be exposed. A full-view operating console controls

the complete system, including any desired combination of optional equipment, accessories and instrumentation . . . flexibility that provides the exact answer to your vibration test system needs.

NOTE THESE ADVANTAGES . . .

SAFE . . . High voltage safety interlock protects operating personnel . . . double clipping amplifier and shaker armature protector prevent equipment damage.

COMPLETE instrumentation and metering provides greater set-up speed for a valuable saving in man hours—simplified control of either intermittent or continuous test cycles.

ADVANCED ELECTRONIC POWER SUPPLY DESIGN provides unsurpassed reliability . . . simplified operation that eliminates need for highly skilled engineering technicians.

WALK-IN CONSTRUCTION provides easy access to power supply components and circuitry.

WIDE CHOICE of accessories and optional equipment to cover the full range of complex and sine wave vibration testing.

WRITE FOR TECHNICAL DATA and specifications on LM Vibration Test Systems . . . a complete line, engineered for every application . . . unmatched for performance and reliability.



LM ELECTRONICS INC.
5017 EXPOSITION BLVD., LOS ANGELES 16, CALIF.
REpublic 2-6618

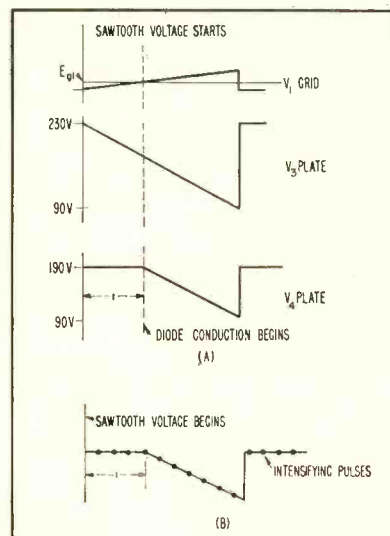

FIG. 2—Waveforms at various points in measuring circuit (A) and typical oscilloscope pattern with timing markers (B)

by the succeeding stages such that the waveform at the plate of pentode V_3 is an amplified and inverted replica of it.

When the diode is conducting its plate waveform will be essentially the same as that at the plate of the pentode.

When the diode is not conducting, however, its plate is held at 190 volts by the voltage divider. Since the diode does not start to conduct until its cathode becomes negative with respect to its plate, the plate waveform of the diode will be essentially that part of the plate waveform of the pentode that is below 190 volts. The plate waveforms of the pentode and diode are shown in Fig. 2A.

The plate voltage of the pentode at the time when the diode begins to conduct (190 volts) corresponds to a definite voltage E_{g1} on the grid of V_1 . When this grid voltage is more positive than E_{g1} , the pentode plate voltage will be less than 190 volts and the diode will conduct. From Fig. 2A it can be seen that there is a sharp break in the diode plate voltage as the grid voltage of V_1 becomes more positive than E_{g1} .

The waveform at the diode plate is applied to an oscilloscope used to measure the time interval between the start of the sawtooth and the instant that the grid voltage of V_1 reaches E_{g1} (the point where diode conduction begins). To make this time measurement, a pulse gener-



These tubes died young; a G-E Inductrol might have saved them

Fluctuating voltage killed these electronic tubes off young. Over-voltage murdered most . . . a five percent overvoltage cuts tube life by almost 50 percent (see chart below). Undervoltage, which resulted in cathode bombardment of gas or mercury-filled types, ruined more. Even while in use, poor voltage regulation made these tubes perform erratically. And when they died, downtime costs and replacement costs ran high.

Good voltage gives you maximum tube performance. General Electric Inductrols—dry-type induction voltage regulators—are the answer for circuits up to 600 volts, 520 kva. They automatically maintain constant output voltage, assuring accuracy and peak performance of electronic equipment. There are no steps, no brushes to maintain. Wave form distortion is negligible. Regulation is done magnetically, with $\pm 1\%$ band width. Manufacturers are building Inductrols into induction heating equipment, radar gear, radio and TV transmitters, computers—to get consistent performance wherever voltage is critical.

TUBE-LIFE AND PERFORMANCE VS VOLTAGE

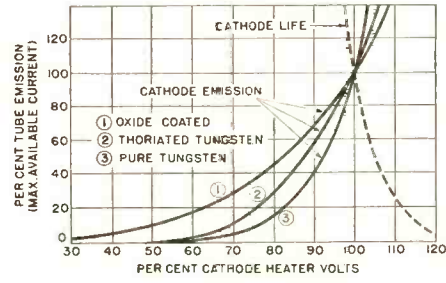

3 TYPES AVAILABLE

G-E Inductrols come with manual, motor-operated, or completely automatic controls. See your G-E Apparatus Sales Office or Agent. Or, send us the coupon. General Electric Co., Schenectady 5, N. Y.

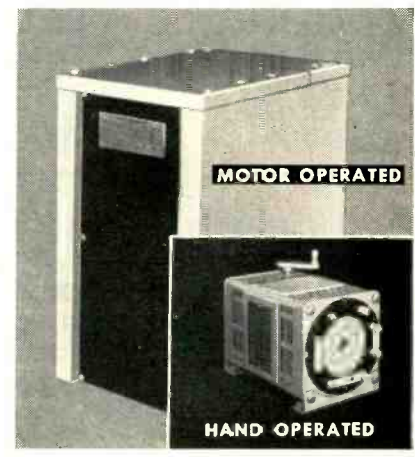

Progress Is Our Most Important Product

GENERAL  ELECTRIC

TELL ME MORE! I'm interested in G-E Inductrols. Please send me these bulletins:

- Voltage Deviation on Electronic Tubes and the Use of Inductrols.....GEA-5936
- Single-phase Inductrols, indoor service, 600 volts and below on circuits up to 240 kva.....GEC-795A
- Three-phase Inductrols, indoor service, 600 volts and below on circuits up to 520 kva.....GEA-5824

General Electric Company
Section C423-211, Schenectady 5, N. Y.

Name

Company

Address

City State

new

CAMLOC
ELECTRONIC
CHASSIS LATCH

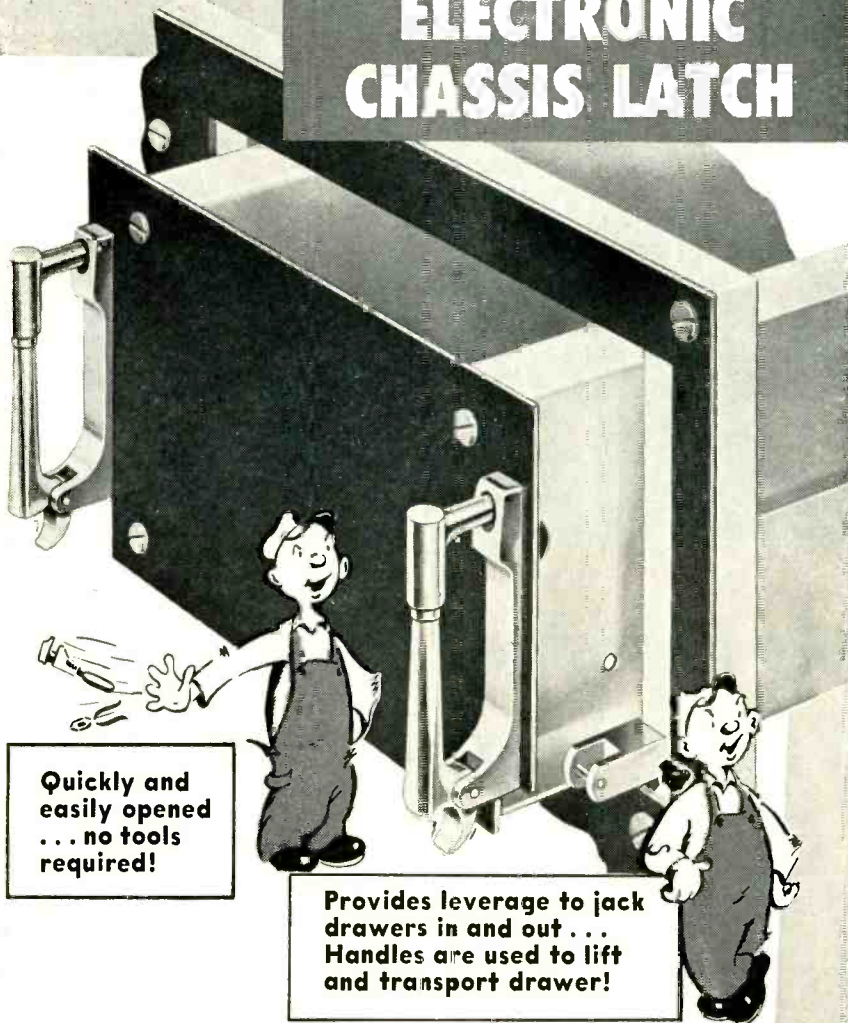

Quickly and easily opened . . . no tools required!

Provides leverage to jack drawers in and out . . . Handles are used to lift and transport drawer!

The new Camloc Electronic Chassis Latch does away with protruding attaching bolts, hole preparation, sealing problems . . . cuts down production time . . . adds attractive, modern design to equipment racks. Camloc Electronic Chassis Latches not only provide leverage to overcome friction of multiple plug or chassis assembly, but also serve as carrying handles. It requires just a 6-pound maximum load to disengage the lock, yet the maximum horizontal working load—per latch—is 400 pounds!

Detailed information about the Camloc Electronic Chassis Latch is available on request. Write for Bulletin L-21.



CAMLOC
FASTENER CORPORATION
75 Spring Valley Road, Paramus, N. J.

WEST COAST OFFICE: 5410 WILSHIRE BLVD., LOS ANGELES, CAL.

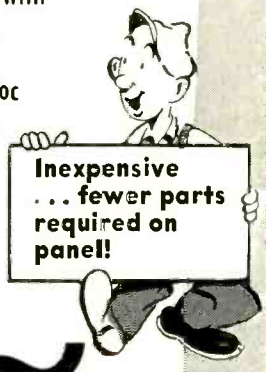

Inexpensive . . . fewer parts required on panel!

ator with precisely spaced pulses is needed. The pulses are used to intensity modulate the oscilloscope trace at equal intervals of time and are synchronized to start at the instant that the test sawtooth begins.

If the time interval between the pulses is accurately known, the time between the start of the sawtooth and the instant that the grid voltage of V_1 reaches E_{g1} can be measured by counting the number of pulse intervals between the beginning of the test sawtooth and the break in the diode plate waveform. A typical oscilloscope waveform is shown in Fig. 2B.

The above discussion describes a method of determining the time between the start of the sweep and the instant the grid voltage of V_1 reaches E_{g1} . This time interval will be the abscissa of a point on the sawtooth. It is now desired to find a way of obtaining the ordinate of this point. In other words, the amplitude of the input waveform at the instant that the grid voltage of V_1 reaches E_{g1} must be determined. This is done by considering the input circuit of Fig. 1, where e_s is the instantaneous input sawtooth voltage, e_g is the instantaneous grid voltage of V_1 , E_{g1} is the grid voltage of V_1 at the instant that the diode begins conduction (E_{g1} is a constant in any given circuit), and E_{cc} is the d-c bias voltage. The following equation can be written for the input circuit

$$e_g = \frac{E_{cc} + e_s}{R_1 + R_2} R_2 - E_{cc} \quad (1)$$

when $e_g = E_{g1}$, the equations can be rewritten as

$$E_{g1} = \frac{E_{cc} + e_s}{R_1 + R_2} R_2 - E_{cc}$$

$$E_{g1} = \frac{R_2}{R_1 + R_2} e_s +$$

$$E_{cc} \left(\frac{R_2}{R_1 + R_2} - 1 \right)$$

$$= \frac{R_2}{R_1 + R_2} e_s - \frac{R_1}{R_1 + R_2} E_{cc}$$

OR

$$e_s = \frac{R_1 + R_2}{R_2} E_{g1} + \frac{R_1}{R_2} E_{cc} \quad (2)$$

If $R_1 = R_2$, then

$$e_s = 2E_{g1} + E_{cc} \quad (3)$$

Therefore, the amplitude of the

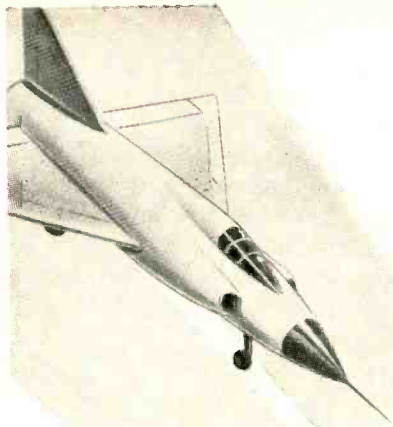

Need a special potentiometer design? Our engineers are specialists in designing sub-miniature potentiometers, sector and open card winding potentiometers, and other combinations of special factors and functions. As the leader in standard precision potentiometer production, Fairchild has all the advanced techniques and facilities to give you fast service on both test models and production runs of potentiometers built to your exacting requirements.

SPECIAL POTENTIOMETERS for your special needs

This is a special sector potentiometer. It came into being when the Eclipse-Pioneer Division of the Bendix Aviation Corporation needed a potentiometer with gear drive to mount within limited space in the altitude compensator of their Beam Guidance System. Excessive torque would cause inaccurate readings and result in unsatisfactory operation of the system, so a potentiometer with minimum torque was necessary. Since space limitations dictated an unusual configuration, our engineers worked with Eclipse-Pioneer engineers to develop this special design. The critical torque requirements of 0.075 oz.-in. on a 4 gang unit were met by specially designed wipers, windings, and slip rings. This same constructive cooperation can help you when you need a special or a standard potentiometer. So, call Fairchild first. Potentiometer Division, Fairchild Controls Corp., a subsidiary of Fairchild Camera & Instrument Corp., 225 Park Ave., Hicksville, N. Y., Dept. 140-67A1.

EAST COAST
225 Park Avenue
Hicksville, L. I., N. Y.

WEST COAST
6111 E. Washington Blvd.
Los Angeles, Cal.

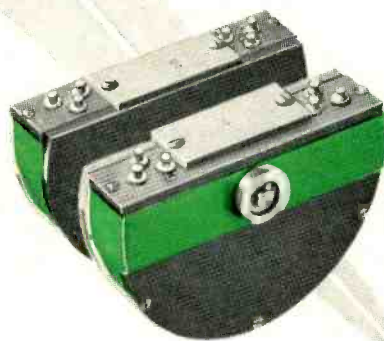

FAIRCHILD
PRECISION POTENTIOMETERS

they shall not pass!

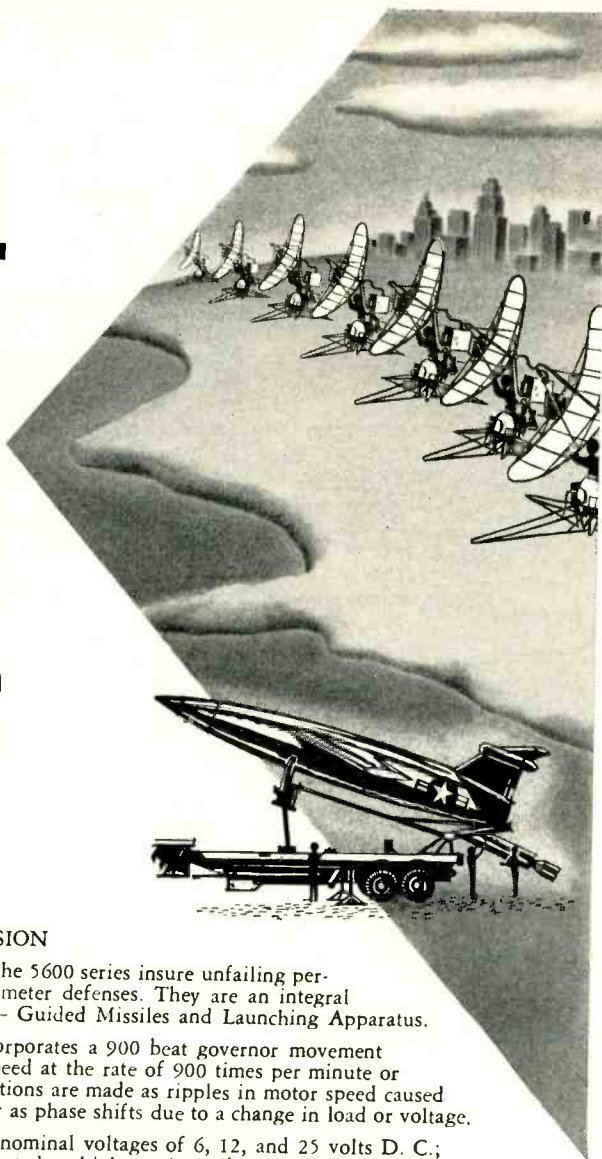

A. W. HAYDON PRECISION

Governed D. C. Motors like the 5600 series insure unfailing performance of America's perimeter defenses. They are an integral part of "Hogan's Fence" — Guided Missiles and Launching Apparatus.

The 5600 series motor incorporates a 900 beat governor movement which corrects the motor speed at the rate of 900 times per minute or 15 times per second. Corrections are made as ripples in motor speed caused by the pulsing of contacts or as phase shifts due to a change in load or voltage.

Windings are available for nominal voltages of 6, 12, and 25 volts D. C.; however motors may be operated on higher voltages by means of a voltage divider resistor. Output speeds from 900 RPM down to 1 revolution in 2 hours can be provided.

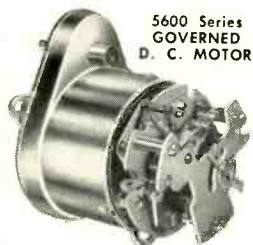

5600 Series
GOVERNED
D. C. MOTOR

SPECIFICATIONS

1. Voltage range nominal $\pm 20\%$ at 68°F.
2. Ambient temp. range minus 65°F to plus 165°F.
3. Vibration 5-55 cycles per sec. with 10g max. accel.
4. Tolerance on escapement rate:
 - (a) $\pm 0.1\%$ under condition 1
 - (b) $\pm 0.3\%$ under condition 2
 - (c) $\pm 0.5\%$ under condition 3
5. Shock — per MIL-E-5272A, Proc. 1 (30g for 11ms)

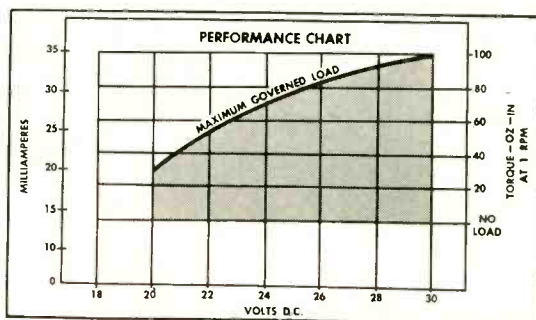

Rated 30 oz. — in. full load torque at 1 RPM. Torque is limited by materials used in gear train to 20 oz. — in. intermittent or 5 oz. — in. continuous duty at 1 RPM. Special gear trains are available.

WHEN TIMING POSES A PROBLEM CONSULT . . .

The
A. W. HAYDON Company

235 NORTH ELM STREET, WATERBURY 20, CONNECTICUT

Design and Manufacture of Electro-Mechanical Timing Devices

(General
Catalog
Sent on
Request)



input sawtooth at the instant that e_p reaches E_{p1} is equal to E_{cc} plus a constant. Voltage E_{cc} can be measured accurately. The value E_{p1} is a constant of the circuit, which can be evaluated by letting $e_s = 0$ (grounding the input) and varying E_{cc} until the diode just begins to conduct. In this case

$$\frac{R_1 + R_2}{R_2} E_{p1} = - \frac{R_1}{R_2} E_{cc}$$

$$E_{p1} = - \frac{R_2}{R_1 + R_2} E_{cc} \quad (4)$$

This provides a way of measuring the amplitude of the input sawtooth at the instant that the pentode grid voltage reaches E_{p1} . Since the bias voltage E_{cc} is variable, the instant that e_p reaches E_{p1} can be varied from the beginning to the end of the sawtooth. This makes it possible to measure the amplitude and timing of any point on the input waveform.

The most convenient way of obtaining a set of these measurements is to vary the bias potential so that the break in the diode plate waveform occurs at successive intensifier pulses. In this way the amplitude of the input sawtooth can be measured at equal time intervals. These measurements can be used to make a plot of the actual input sawtooth voltage. This graph can then be compared to an ideal sawtooth to determine the departure from linearity. If the departure is small, however, ordinary graphical comparison may be difficult. In this case a plot of the difference between corresponding ordinates of the actual and ideal sawtooth waveforms can be made. This graph is then a plot of the deviation of the input sawtooth from perfect linearity.

This system places no requirements on the linearity of the pentode or the triodes. As long as these tubes are operating in a reasonably linear region at the instant the diode begins to conduct, the accuracy of this method will be in-

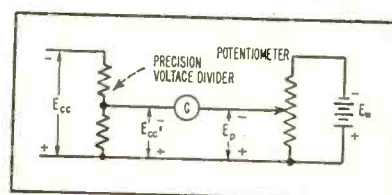

FIG. 3—Potentiometer circuit for measuring sawtooth voltage level

NOW . . . FROM

Transitron[®]

GOLD BONDED COMPUTER DIODES

designed for specific applications

Whether your computer circuit calls for high back resistance, high forward conductance, good pulse recovery characteristics — or any combination of these — Transitron has a special diode type best suited to your needs. These diodes combine superior electrical performance with true hermetic sealing to provide the utmost in reliability.

SPECIFICATIONS & MAXIMUM RATINGS AT 25°C

TYPE	Current at +1V. (ma)	Inverse Current (μ a Max.)	Cont. Inverse Voltage	DESCRIPTION
T15G	125	500K between -20 and -90V	90	Inverse Recovery Time Tested.
T16G	40	500K between -10 and -50V	60	Forward & Inverse Recovery Time Tested.
1N191	5	400K between -10 and -50V @ 55°C	60	Inverse Recovery Time Tested.
1N192	5	200K between -10 and -50V @ 55°C	60	Inverse Recovery Time Tested.
1N270	200	100 @ -50V	60	LOW IMPEDANCE FAST FORWARD SWITCHING TIME.
1N283	200	20 @ -10V	20	
1N273	100	20 @ -20V	30	(useful for magnetic core switching)
1N279	100	200 @ -20V	30	
T5G	40	100 @ -100V	100	Hi Res.-Hi Cond.
1N67A	5	50 @ -50V 5 @ -5V	80	Hi Resistance
T3G	20	50 @ -50V	60	Hi Res.-Hi Cond.
T2G	40	300 @ -50V	60	Hi Conductance

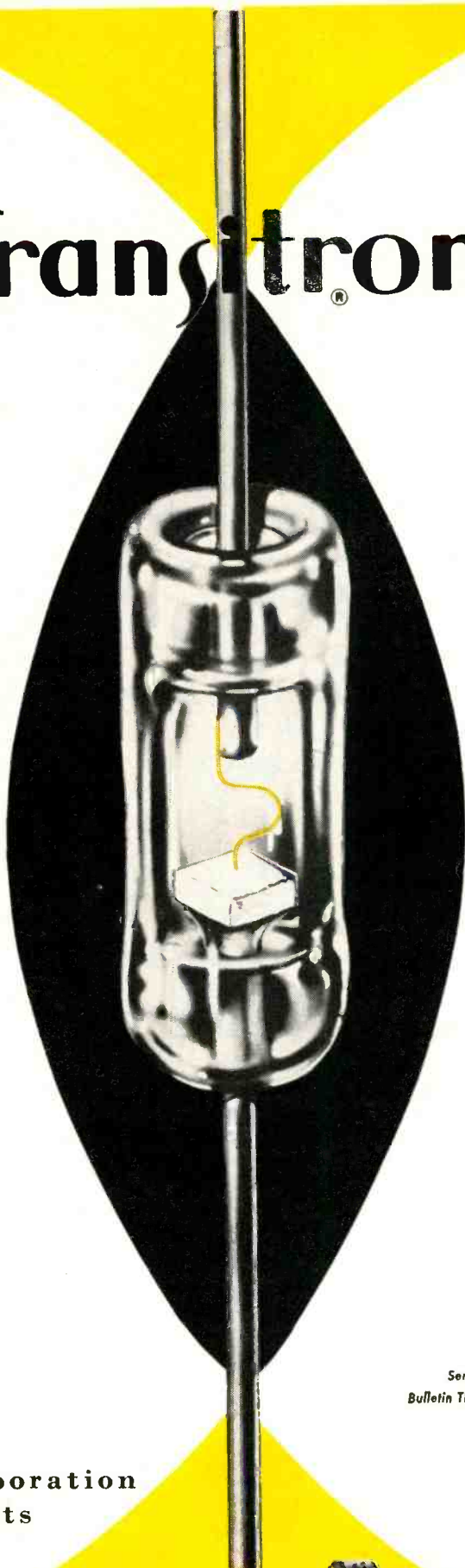

actual size

Send for
Bulletin TE1319.



Transitron electronic corporation
melrose 76, massachusetts



Germanium Diodes



Silicon Rectifiers



Transistors



Power Transistors



Silicon Diodes

HERE'S HELP IN TESTING

INSTRUMENTS
EQUIPMENT
PARTS
COMPONENTS
MATERIALS

A single test to check your own findings
— or a complete qualification series to
satisfy your customer or the Government.*

13 Laboratories within 1 Organization

To do your testing, E.T.L. maintains thirteen separate well equipped, fully staffed laboratories in these fields:

Electronic*	Mechanical	Radioactive
Environmental	Physical	Spectrophotometric
Electrical	Photometric	Ultrasonic
Chemical	Radiometric	X-ray
	Photomicrographic	

*In the Electronic field, for instance, measurements and determinations can be made over extreme high and low range of parameters for the usual characteristics such as Capacitance, Resistance, Frequency (including the microwave region), Power, Power Factor, Interference, etc. Qualification Tests can be made to Military Specifications such as:

ASESA List No. 100	Electronic Parts and Materials
MIL-E-5272	Electronic Equipment, Aeronautical
MIL-E-5400	Electronic Equipment, Airborne
MIL-E-8189	Electronic Equipment, Pilotless
MIL-I-6181	Electronic Equipment, Interference
MIL-STD-108	
MIL-STD-202	
MIL-L-770	Radioactive Material
MIL-L-25412	Luminescent Material—Fluorescent

E.T.L. Services are independent, impartial, and as confidential as your own. Using E.T.L. Services is like finding extra trained talent and extra test equipment without adding to your payroll or capital investment.

A detailed list of services and facilities will be supplied on request

Testing for Industry  for 60 Years

ELECTRICAL TESTING LABORATORIES, INC.
2 EAST END AVENUE • BUTTERFIELD 8-2600 • NEW YORK 21, N. Y.

dependent of any distortion introduced by them. The accuracy of the system, however, does depend on the precision with which the time and voltage measurements can be made.

Time measurements will be considered first. The intensifying pulses must be both of constant time interval and synchronized with the beginning of the sawtooth. This is easily accomplished by gating the pulse generator to start at the instant that the sawtooth starts or vice-versa.

It has been assumed that the break in the diode plate waveform is very sharp. If the slope of the input waveform is small, however, the break may not be sharp because the diode does not go from cutoff to full conduction instantaneously. This results since an increase in plate voltage of a few tenths of a volt is required to make a diode, which is just beyond cutoff, conduct heavily. The time required for this change to take place is inversely proportional to the slope of the amplified sawtooth that is applied to the cathode of the diode. A sharp break may thus be obtained by increasing the slope of this wave-

Computer-Controlled Stabilizing Fin

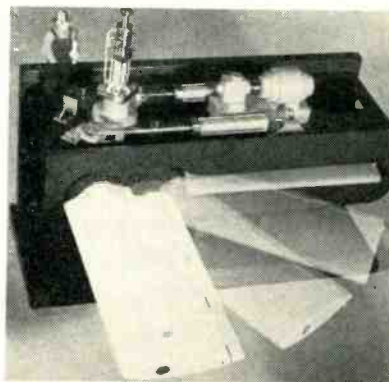

Consistently cutting 20-degree rolls to less than 2 degrees, the new Sperry Gyrofin ship stabilizer uses electronic techniques. The photograph shows how the fin can be swung out into the slip stream of the ship's hull where its tilting action develops roll-countering forces. Although moved into desired position hydraulically, computer techniques operate through magnetic amplifiers in response to strain-gage signals to tilt fins. Two fins are used for merchant vessels, each one exerting up to 3,000 foot-tons of lift. Model shows retracted fin being moved out into slip stream of ship's hull

PROVED!

Because of their proven ability to deliver double the normal life... these two **AMPEREX** heavy duty triodes have already replaced approximately one third of conventional types in existing sockets!

SPECIALLY DESIGNED FOR HEAVY DUTY RF INDUSTRIAL APPLICATIONS

TYPE 6333 (WATER COOLED)

Plate Dissipation 10 kilowatts. Furnished with grid connector for direct interchangeability with type 892 without any equipment modifications. Suitable for communications as well as industrial applications. Available in air-cooled version, Type 6445.

TYPE 6446 (WATER COOLED)

A heavy wall triode capable of dissipating 20 kilowatts continuously. Massive anode (7/16" thick), provides high heat storage capacity for heavy intermittent duty. High dissipation reserve allows extreme mismatch of load to tube impedance. The tube is therefore protected against maladjustment or misuse of equipment. Uses only 1/2 the water flow required for type 892, for equivalent anode dissipation. Available in air-cooled version, Type 6447.

OPERATING DATA, 6333

RF POWER AMPLIFIER and OSCILLATOR CLASS C TELEGRAPHY

	MAXIMUM RATING per tube	TYPICAL OPERATION one tube
AC Filament Voltage	—	22 volts
DC Plate Voltage	15000	12000 volts
DC Grid Voltage	3000	1600 volts
Plate Load Resistance	—	3500 ohms
Peak RF Grid Voltage	—	2600 volts
DC Plate Current	2	1.55 amps
Plate Input	30	18.60 kw
Plate Dissipation	10	4.35 kw
DC Grid Current (approx.)	400	165 ma
Driving Power (approx.)	—	420 watts
Plate Power Output	—	14.25 kw
Tube Power Output	—	745 BTU/min.

OPERATING DATA, 6446 RF INDUSTRIAL OSCILLATOR

(3 PHASE, FULL WAVE, UNFILTERED SUPPLY)

	MAXIMUM RATING per tube	TYPICAL OPERATION one tube
AC Filament Voltage	—	21.8 volts
DC Plate Voltage	15000	1200 volts
DC Grid Voltage	— 3000	— 500 volts
Peak RF Grid Voltage	—	1460 volts
Plate Current	2	2 amps
Plate Input	30	24 kw
Plate Dissipation	20	6.5 kw
DC Grid Current	400	230 ma
Drive Power (approx.)	—	300 watts
Plate Power Output	—	17.5 kw
Tube Output	—	996 BTU/min.

DIRECT INTERELECTRODE CAPACITANCES

Grid to Plate	32 $\mu\mu\text{f}$
Grid to Filament	17 $\mu\mu\text{f}$
Plate to Filament	1.8 $\mu\mu\text{f}$

LIST PRICES:

6333 (Water Cooled)	\$230.00
6445 (Forced Air Cooled)	375.00
6446 (Water Cooled)	255.00
6447 (Forced Air Cooled)	400.00

ACCESSORIES

Tube Type	Water Jacket	Grid Connector
6333	DW-1580	Y-13326 (Supplied with tube without charge)
6446	S-15096	Y-13326 (Supplied with tube without charge)

Complete technical data available from our
Application Engineering Department

CONDENSED TUBE CATALOG

... yours for the asking! Comprehensive, quick-reference guide on all Amperex tubes. Helps you find, in a moment, the tube or tubes that will fit your industrial and communication jobs.



AMPEREX tubes give you better performance and longer life, Physically and Electrically, through these exclusive RUGGEDIZING techniques:

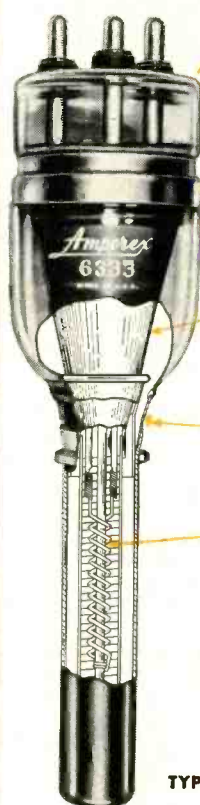

1 Rugged, powdered glass stem replaces stem press construction. Runs about 150° cooler, minimizing failure due to thermal shock. Glass matches coefficient of expansion to Kovar over wider temperature ranges minimizing mechanical stress failure.

2 Projecting grid arm eliminated and replaced with strong Kovar ring grid connection.

3 Strong conical internal grid support instead of three-legged riveted construction. This also provides much lower inductance.

4 Fragile copper "feather-edge" glass-to-anode seal replaced by a rugged Kovar seal.

5 New, stronger helical filament provides more uniform heat distribution over the anode surface.

6 7/16 inch thick, high conductivity copper anode for heavy duty applications.

TYPE 6333

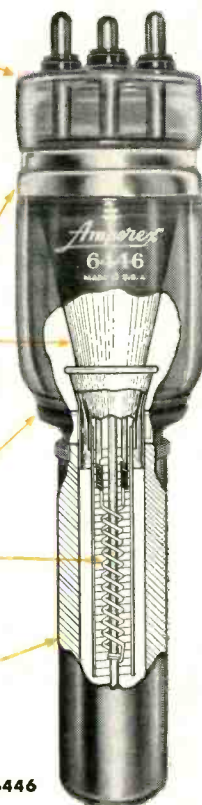

TYPE 6446

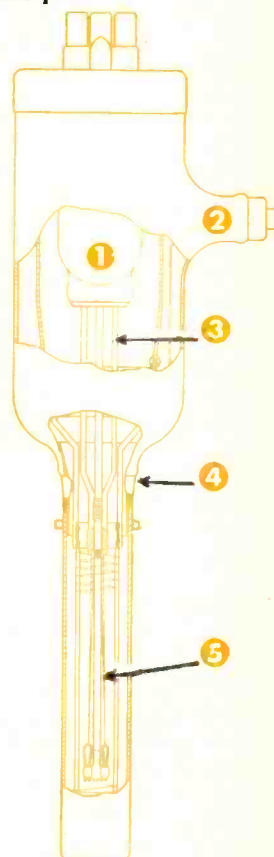

CONVENTIONAL TUBE STRUCTURE

Available At Your Local Parts Distributor

AMPEREX ELECTRONIC CORP.

230 Duffy Ave., Hicksville, Long Island, N. Y.

In Canada: Rogers Majestic Electronics Ltd.
11-19 Brentcliffe Road, Leaside (Toronto) 17

LAB PULSESCOPE

by

Waterman



MODEL
S-5-A

Size:
13" x 16½" x 14½"

ANOTHER EXAMPLE OF **Waterman** PIONEERING...

The LAB PULSESCOPE, model S-5-A, is a JANized (Gov't Model No. OS-26) compact, wide band laboratory oscilloscope for the study of all attributes of complex waveforms. The video amplifier response is up to 11 MC and provides an equivalent pulse rise time of 0.035 microseconds. Its 0.1 volt p to p/inch sensitivity and 0.55 microsecond fixed delay assure portrayal of the leading edge when the sweep is triggered by the displayed signal. An adjustable precision calibration voltage is incorporated. The sweep may be operated in either triggered or repetitive modes from 1.2 to 120,000 microseconds. Optional sweep expansion of 10 to 1 and built-in markers of 0.2, 1, 10, 100, and 500 microseconds, which are automatically synchronized with the sweep, extend time interpretations to a new dimension. Either polarity of the internally generated trigger voltage is available for synchronizing any associated test apparatus. Operation from 50 to 400 cps at 115 volts widens the field application of the unit. These and countless additional features of the LAB PULSESCOPE make it a MUST for every electronic laboratory.

WATERMAN PRODUCTS CO., INC.

PHILADELPHIA 25, PA.

CABLE ADDRESS: POKETSCOPE

WATERMAN PRODUCTS INCLUDE

S-4-C SAR PULSESCOPE®
S-5-A LAB PULSESCOPE
S-6-A BROADBAND PULSESCOPE
S-11-A INDUSTRIAL POKETSCOPE®
S-12-B JANized RAKSCOPE®
S-14-A HIGH GAIN POKETSCOPE
S-14-B WIDE BAND POKETSCOPE
S-15-A TWIN TUBE POKETSCOPE
RAYONIC® Cathode Ray Tubes
and Other Associated Equipment

MEMO...
Write for details today!

WATERMAN PRODUCTS

form. This can be accomplished by adding more stages of gain between V_2 and V_3 .

The voltage E_{cc} is most accurately measured by using a precision voltage divider, galvanometer and precision potentiometer as shown in Fig. 3. The precision voltage divider is used to obtain a voltage small enough to measure using the precision potentiometer. The potential is measured by varying the potentiometer setting until no current flows through the galvanometer.

When this occurs E_p is equal to E_{cc}' . If a potentiometer such as the Leeds and Northrup Type K is used, E_p can be read directly from the potentiometer dials. The potentiometer also can be conveniently calibrated with a standard cell so the voltage measurements will be accurate to better than 0.1 percent. Once E_{cc}' is known, E_{cc} can be calculated by dividing E_{cc}' by the ratio of the volt box. The amplitude of the input sawtooth at the point of measurement can then be calculated using Eq. 2 or Eq. 3.

Accuracy

The above discussion assumes that E_{cc} is a pure d-c voltage and that no sawtooth appears at its output. This will be true only if the output impedance of the bias voltage source is negligible compared with R_s . A feedback amplifier was used in this case to obtain a variable voltage source with an extremely low output impedance. A multiturn potentiometer was used to control the output of this source to make fine adjustment of E_{cc} possible.

The overall accuracy of this method would be seriously affected by any drift in any of the potentials of the circuit. Therefore, the circuit should always be allowed to warm up long enough to become stabilized, before any measurements are made. Several other precautions are also necessary if drift is to be minimized. The +300, +150 and -300 supply voltages should be obtained from well-regulated and essentially drift-free sources. The heater voltages of all of the tubes should be extremely stable. This can be accomplished either by using a constant voltage transformer or by feeding

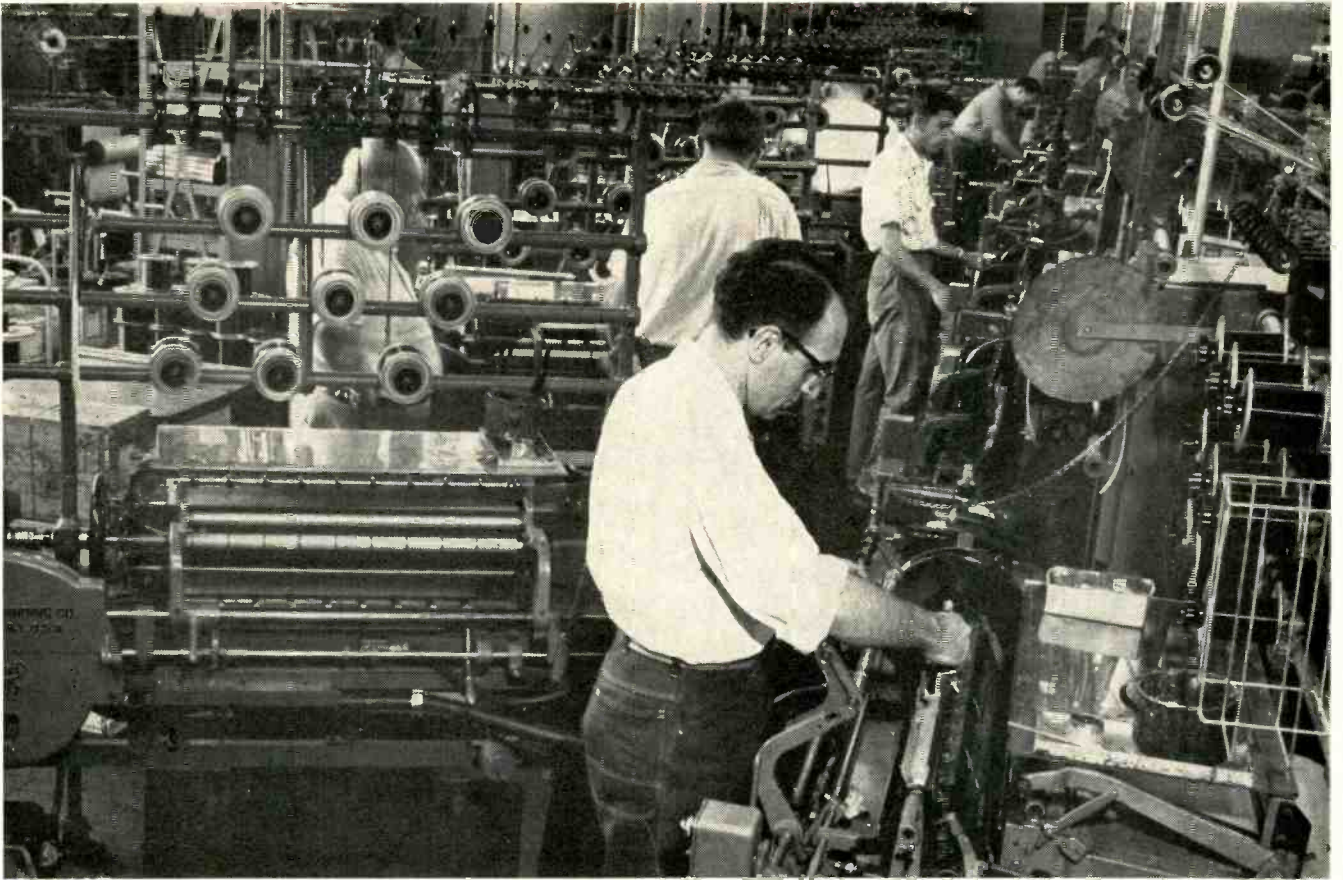

Installation of Leeson No. 107 Coil Winders at Ford Motor Company's Ypsilanti, Michigan, plant. New Paper Miss Detector enables operator to tend two machines.

Now FORD Motor Co. winds ignition coils on Leeson No. 107 winders

*Machines stop
automatically if there's a
paper miss . . . one operator
tends two machines . . .*

These Leeson No. 107 Coil Winders, equipped with the new Paper Miss Detector, make quantity production of high-quality stick-wound coils virtually foolproof.

Humidity changes can cause the

paper to curl and miss an insert. Ordinarily, if there's a paper miss, and the machine is unattended, it continues to wind. Result . . . a worthless stick plus money wasted in wire and time. So an operator must be in constant attendance on each machine.

The new Leeson Paper Miss Detector cures this . . . by automatically stopping the machine. Thus, constant machine attendance is unnecessary.

• One operator can handle two or

three machines.

- Operator's coil production increases.
- Rejection rate is reduced . . . when the machine stops at a paper miss the operator re-inserts the paper, starts the machine which continues to wind an excellent stick of coils.

For the full story on Leeson No. 107 Coil Winders, and other helpful information write or get in touch with Universal.

B.5.2

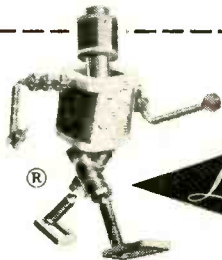

FOR WINDING COILS
IN QUANTITY . . . ACCURATELY
. . . AUTOMATICALLY . . . USE
UNIVERSAL WINDING MACHINES

UNIVERSAL WINDING COMPANY

P. O. BOX 1605, PROVIDENCE 1, RHODE ISLAND, Dept. 211

E. G. PAULES & COMPANY, 1762 West Vernon Avenue, Los Angeles, California
Western Representatives

W. J. WESTAWAY & COMPANY, LIMITED, Montreal & Hamilton, Canada
Canadian Representatives

UNIVERSAL WINDING COMPANY, 9 South Clinton Street, Chicago, Illinois

UNIVERSAL WINDING COMPANY, 1500 Walnut Street, Philadelphia, Pennsylvania

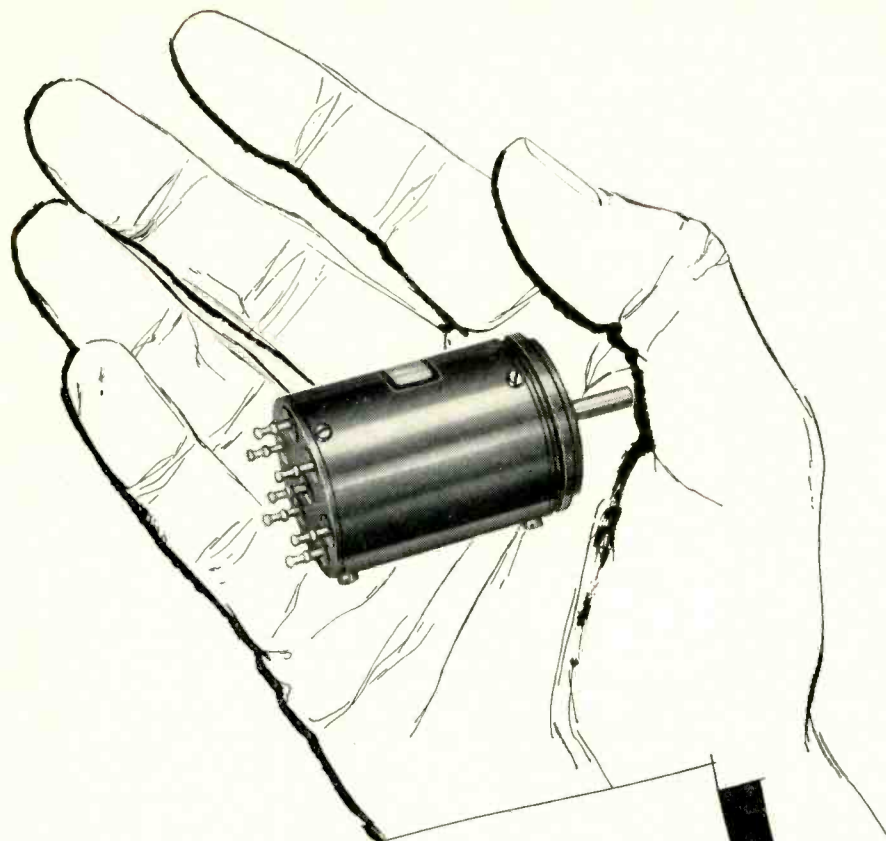

Here is the new
GAMEWELL
 Miniature Sine-Cosine Potentiometer

This miniature version of the conventional RL-11 and RL-14 sinusoidal potentiometers is $1\frac{1}{16}$ " diameter x $1\frac{1}{16}$ " long.

Functions of this new Gamewell Precision Potentiometer are accurately and smoothly developed. Four brush contacts move over a uniformly wound rectangular card and pick off output voltages that are proportional to the sine and cosine of the input angle at speeds up to 60 RPM. Standard resistance value is 18K, but resistance from 4K to 25K can be supplied. Accuracy at higher values is $\pm 1\%$. Power rating: 1 watt $\pm 40^\circ\text{C}$.

THE GAMEWELL COMPANY
 NEWTON UPPER FALLS 64, MASS.
 In Canada: Northern Electric Co., Ltd.

For information
 about this new sine-cosine
 Gamewell Potentiometer,
 write today.

GAMEWELL[®]

PRECISION POTENTIOMETERS

Manufacturers of Precision Electrical Equipment Since 1855

the heaters from a regulated d-c source. All resistors should be types that are known to be very stable. It is also recommended that no resistor ever be required to dissipate more than approximately one-fourth rated power.

The system described in this paper has been used to determine the departure from linearity of sawtooth waveforms of amplitudes from 2 to 50 volts and durations up to 2,500 microseconds. From the measurements that were made it was found that the amplitude of the sweep at a particular point could be determined with an accuracy of better than 0.2 percent and that the timing could be measured to better than 3 microseconds. The accuracy can be increased by further refinements in the actual measurement procedures.

The work described here was carried out as part of Air Force Contract AF 30 (602)-300 with the Rome Air Development Center.

Electronic Load

By DONALD FROEMKE
 and V. RONALD NELSON

*Department of Physics
 Augustana College
 Sioux Falls, S. D.*

TESTING performance and regulation of electronic power supplies, generators and dynamotors is generally performed with a resistive

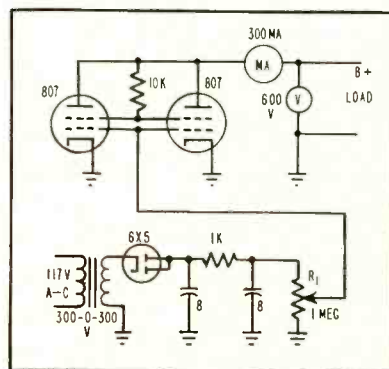

Variable load useful in testing dynamotors or power supplies

load. Such a load is likely to be bulky and does not usually lend itself to fine adjustment of load current.

The device described below provides a variable load without these

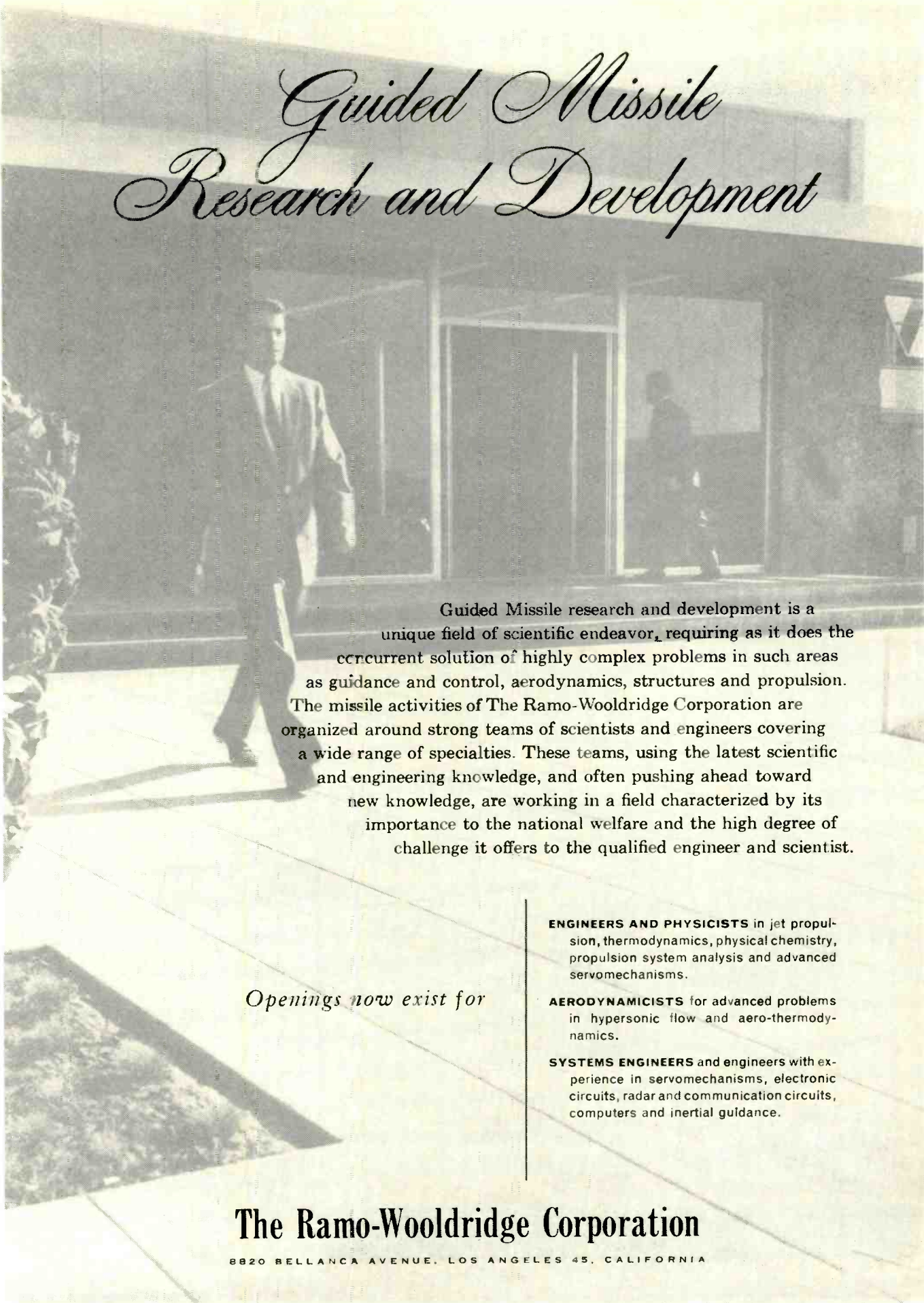

Guided Missile Research and Development

Guided Missile research and development is a unique field of scientific endeavor, requiring as it does the concurrent solution of highly complex problems in such areas as guidance and control, aerodynamics, structures and propulsion. The missile activities of The Ramo-Wooldridge Corporation are organized around strong teams of scientists and engineers covering a wide range of specialties. These teams, using the latest scientific and engineering knowledge, and often pushing ahead toward new knowledge, are working in a field characterized by its importance to the national welfare and the high degree of challenge it offers to the qualified engineer and scientist.

Openings now exist for

ENGINEERS AND PHYSICISTS in jet propulsion, thermodynamics, physical chemistry, propulsion system analysis and advanced servomechanisms.

AERODYNAMICISTS for advanced problems in hypersonic flow and aero-thermodynamics.

SYSTEMS ENGINEERS and engineers with experience in servomechanisms, electronic circuits, radar and communication circuits, computers and inertial guidance.

The Ramo-Wooldridge Corporation

8820 BELLANCA AVENUE, LOS ANGELES 45, CALIFORNIA



a toroid is a shape!

Yes! in the electronics industry a "toroid" is a donut-shaped coil made up of a magnetic core, wire and insulation...

but a

Celco TOROID

IS AN ENGINEERED SHAPE!

Whether it's a complex 10 winding magnetic amplifier or a simple choke... at Celco each toroid is precision-made.

Every job order begins in Celco's Engineering Dept. where toroids are designed to meet customer specifications or operational procedures are prepared to assure proper manufacture of customer designs.

Here at Celco toroidal magnetic amplifiers, transformers and reactors get special handling and testing techniques to realize the advantages of high performance core materials.

Celco's extensive laboratory test and production facilities include modern toroidal winding machines, tool room, machine shop, punch presses, assembly, impregnation, and encapsulating equipment.

Take advantage of the Celco design and production experience in this specialized field. Get a Celco estimate - improve your quality - reduce your cost.

Celco

Constantine Engineering Laboratories Co.

Island Avenue

Mahwah, N. J.

disadvantages listed above.

Two 807 beam power amplifier tubes are paralleled across the voltage source under test. A conventional bias power supply furnishes their grid voltage, which may be controlled by potentiometer R_1 . Thus the drain on the test power supply may be varied from zero at cutoff to the maximum rated plate current. For 807 tubes, maximum plate current is about 200 ma each or a total of 400 ma.

The voltmeter indicates the test supply voltage, making it convenient to collect data for a voltage-current curve on the power supply. Successive readings may be taken close together by fine adjustment of the grid voltage of the 807 tubes.

Maximum recommended plate voltage on these tubes is about 600 volts. In applications involving voltages above 600 volts and currents above 400 ma, tubes with higher ratings should be substituted. Paralleling more tubes will increase the current capacity.

Precision Time-Delay

By WARREN C. STRUVEN

*Radiation Laboratory
Dept. of Physics
University of California
Berkeley, California*

A PRECISION TIME-DELAY circuit has been developed for use with the bevatron magnet-timing equipment. The operating conditions required a circuit with a stability of at least 1 part in 1,000 over a delay range of 150 milliseconds to 2.5 seconds. This circuit has a lower limit of 3 milliseconds and an up-

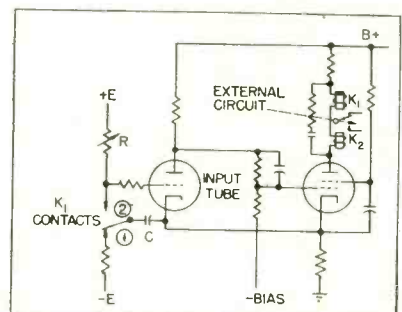

Time-delay unit has additional relay K_2 to provide control of external circuit

UNUSUAL . . . smaller, more reliable transformers made possible with Du Pont MYLAR*

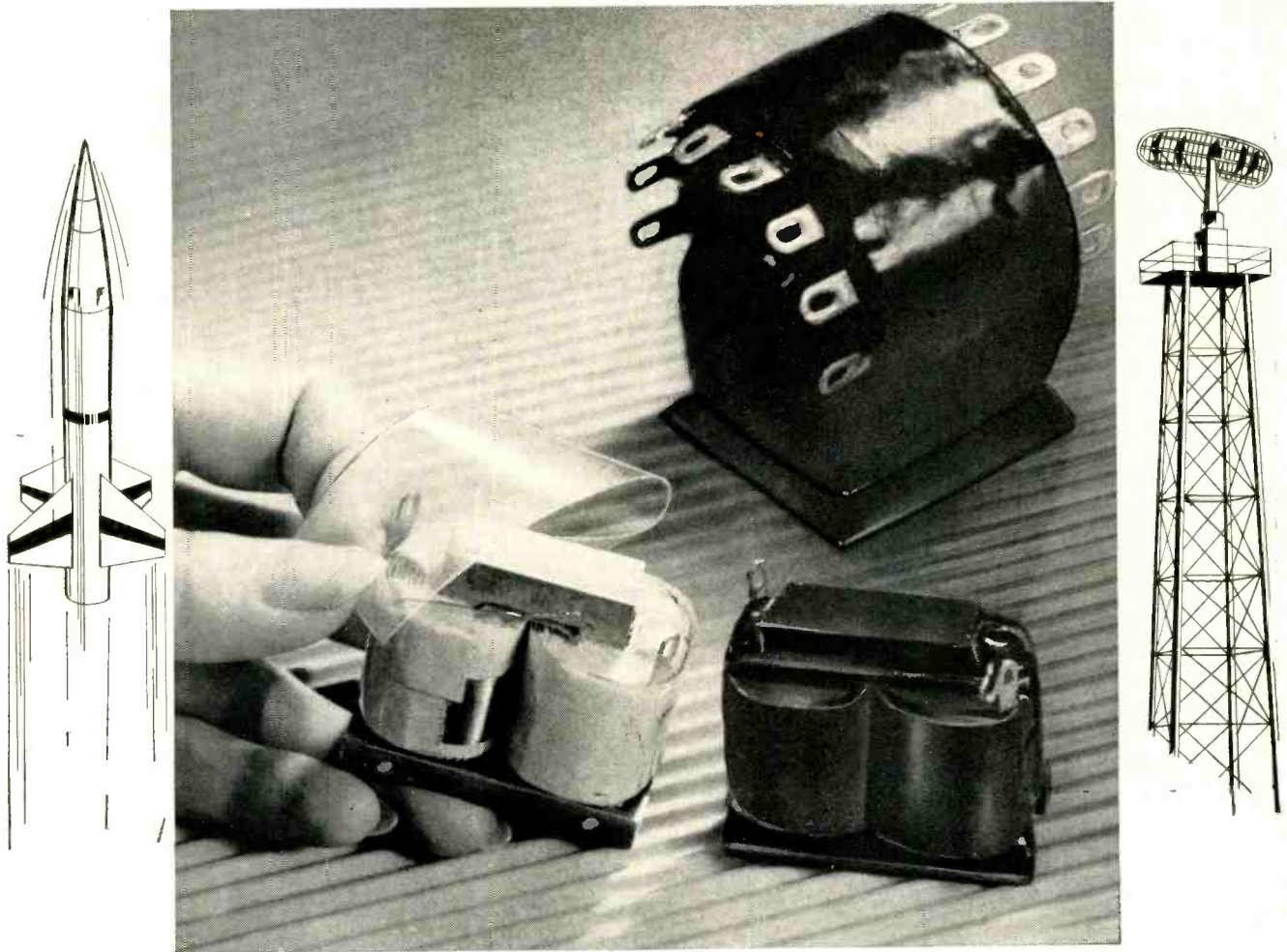

CHALLENGING to industry . . . the almost unlimited opportunities for practical application of this versatile new film

Transformer Engineers, Pasadena, California, use Du Pont "Mylar" polyester film in transformer units for three different radars and two different guided missiles. The company reports that "Mylar," in combination with epoxy resin, has helped save as much as 25% in weight and volume—also helps give their transformers longer life.

Industry everywhere is finding that "Mylar," the strongest of all plastic films, permits a wide range of new and improved products comparable to these revolutionary transformers. A tensile strength of 23,500 p. s. i. permits its manufacture in gauges as thin as $\frac{1}{4}$ of a mil (0.00025 inch).

*"Mylar" is the registered Du Pont trade-mark for its brand of polyester film.

And "Mylar" has a dielectric strength of 4000 volts/mil, is inert to the attack of many solvents and insensitive to moisture. Excellent thermal stability of this new film through a wide temperature range is an added plus.

In a variety of fields, ranging from electrical capacitors to metallized fabrics, versatile Du Pont "Mylar"

is making possible better products . . . lower costs. With just a little research and imagination, you may be able to profitably link "Mylar" to *your* product. Mail the coupon for your free copy of a booklet that tells you more about "Mylar" and the ways it may help you develop or improve a product.

DU PONT

MYLAR®



POLYESTER FILM

Better Things for Better Living . . . through Chemistry

E. I. du Pont de Nemours & Co. (Inc.)
Film Department, Room 8E, Nemours Bldg.
Wilmington 98, Del.

Please send me sample and further information on
"Mylar" polyester film.

Name _____

Firm _____

Street address _____

City _____ State _____

critical potentiometer specs?

— **BOURNS**
has over 200 answers

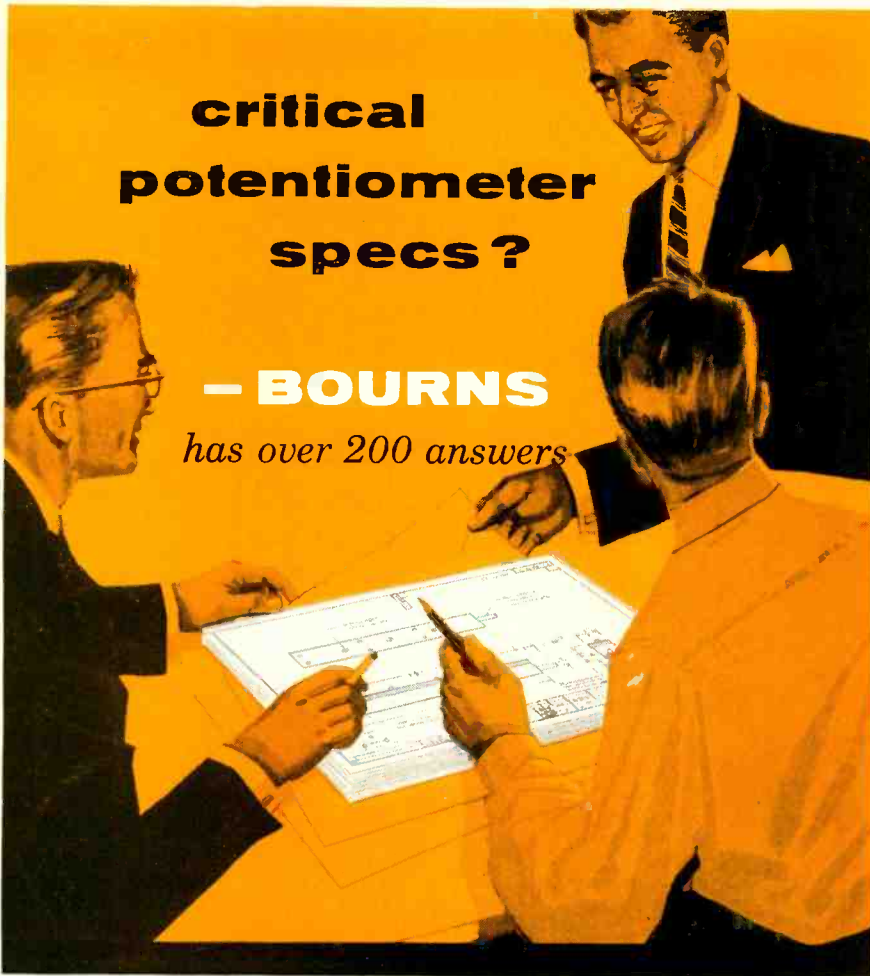

To fit numerous applications, Bourns has 200 designs of miniaturized, high-performance sensing instruments on file. These designs are either standard types, or variations made to meet critical electrical and environmental specifications. The pressure potentiometer designs range from $\frac{1}{2}$ to 10,000 p. s. i. Linear motion units provide travels of $\frac{1}{8}$ " to 30", and you can choose from a wide variety of resistance ranges.

The instrument you need may be among these Bourns designs—ready for production from parts in stock. Or one of the designs now on our boards may meet your specs. If not, we will gladly consider developing the instrument you require. Send us your specifications—your problem may already be solved.



BOURNS LABORATORIES

6135 Magnolia Avenue, Riverside, California
Technical Bulletins on Request, Dept. 12

per limit restricted only by the maximum value of timing capacitor used. Relay contacts are provided for external use if desired.

The circuit shown in the diagram is a modified form of Schmitt trigger where the hysteresis usually associated with the Schmitt circuit is determined mainly by the operation time of the relay. The hysteresis of the usual Schmitt trigger is determined mainly by the value of cathode resistance. The cathode resistance is determined by input-tube gain, the transconductances, plate resistances and the plate load resistances.¹

Operation

In the rest state, capacitor C is charged to $-E$ (relay position 1). When a positive gate is applied to the pentode grid, the pentode is caused to conduct, energizing the relay and moving the contact arm to relay position 2. The triode is immediately cut off and remains cut off until the grid voltage just passes the cutoff voltage, at which time positive feedback cuts off the pentode and restores the circuit to its rest position. The capacitor charges toward $+E$. In the operation, the end of the timing cycle occurs when the capacitor voltage is just slightly more positive than the cathode.

Both $+E$ and $-E$ are of equal value. Therefore, if $+E$ and $-E$ vary, timing accuracy is not materially affected.² This voltage is most easily obtained by grounding the center tap of a regulated supply. The bevatron magnet pulse-timing equipment uses two such circuits. One has a variable range of 0.15 sec to 2.5 sec (time of rectification cycle) and a 2.5-sec lockout circuit to insure that a particular repetition rate is not exceeded. Both circuits have operated for $1\frac{1}{2}$ years with a long-term stability of better than 1 part in 1,000. Jitter from cycle to cycle is less than 1 part in 2,000.

This work was performed under the auspices of the U.S. Atomic Energy Commission.

REFERENCES

- (1) O. Schmitt, A Thermionic Trigger, *Jour Sci Inst*, 15, p 24, Jan. 1938.
- (2) S. Wald, Precision Interval Timer, *ELECTRONICS*, p 88, Dec. 1948.

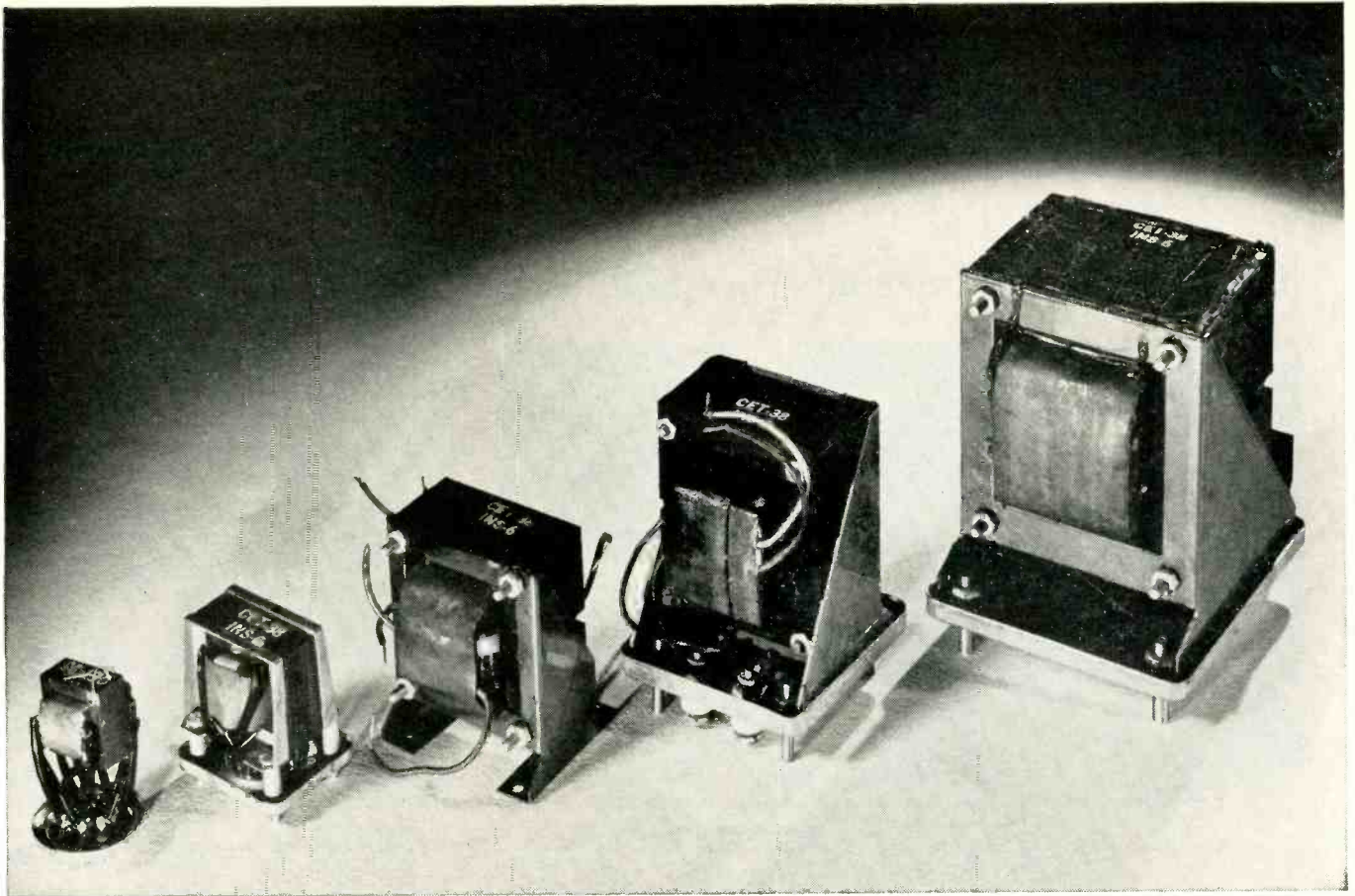

A Transformer becomes a precision device with Allegheny Magnetic Materials in the core



Write for your Copy
"TRANSFORMER LAMINATIONS"

84 pages of valuable technical data on standard and custom-made laminations from all grades of Allegheny Ludlum magnetic core materials. Prepared from carefully checked and certified laboratory and service tests —includes standard dimensions, specifications, weights, etc. Sent free on request . . . ask for your copy.

ADDRESS DEPT. E-71

- ★ ALLEGHENY SILICON STEEL
- ★ ALLEGHENY 4750
- ★ ALLEGHENY MUMETAL

The operation of a transformer is no better than the magnetic core around which it is built. With Allegheny magnetic materials in the core, you get the *best*—uniformly and consistently.

Sure there are reasons why! For one thing, there's the long experience of a pioneer in development and quality control of electrical alloys. But most important, the A-L line offers complete coverage of any requirement you may have, any service specification. It includes all grades of silicon steel sheets or coil strip, as well as Allegheny Silectron (grain-

oriented silicon steel), and a wide selection of special high-permeability alloys such as Allegheny 4750, Mumetal, etc.

In addition, our service on magnetic materials includes complete lamination fabrication and heat treatment facilities. What's more, this extensive experience in our own lamination stamping department is a bonus value for all users of A-L electrical sheets or strip. ● Let us supply *your* needs. *Allegheny Ludlum Steel Corporation, Oliver Bldg., Pittsburgh 22, Pa.*

STEELMAKERS to the Electrical Industry
Allegheny Ludlum

W&D 5333



Three-Operator Assembly-Turntable Boosts Production Rates

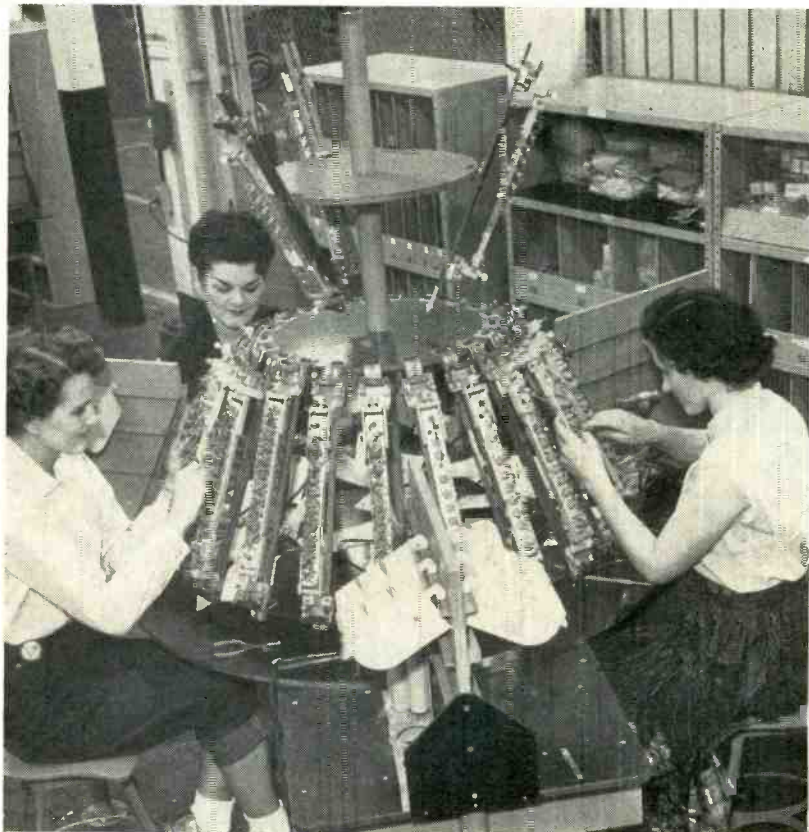

Fixture holding 21 chassis strips rotates freely on pipe going through center of table, to give equivalent of pass-along assembly line in minimum floor space. Table is rotated manually when operators complete assigned work

A ROTATING holding fixture for assembling resistor boards and other flat electronic units used in aircraft electronic equipment has been developed by Martin. The resistor boards are held in a convenient position in front of the operator. As she completes a specified series of operations, the wheel is turned so the next operator can add another series. Sample boards, showing exactly the operations each operator is to complete, are mounted directly above the work. The samples eliminate time lost in checking work diagrams or shop sketches. Each operator is flanked by a table with bins which keep a supply of all the wire, resistors, or other parts required. A shelf for tools is immediately in front of her.

These new fixtures have contributed much to the ease and convenience of doing a difficult, exacting job and have shown positive results in higher production rates and greater accuracy of work.

With three work positions, the assembly can be done in three steps or in multiples of three steps.

Magnetic Holding Tool Makes Parts Serve as Drilling Gage

A SIMPLE magnetic gage expedites the drilling of holes and mounting of two strap metal brackets across a slotted opening in the front of a color-tv receiver cabinet in RCA's Bloomington, Ind. plant. These brackets are required to hold the box that encloses the controls later mounted on the front of the cabinet.

The gage consists of a piece of $\frac{3}{4}$ -inch laminated plastic material having four drilled holes in which are set round permanent magnets. A metal handle is attached for convenience in handling the gage.

The operator places the two mounting brackets in position against the pairs of permanent

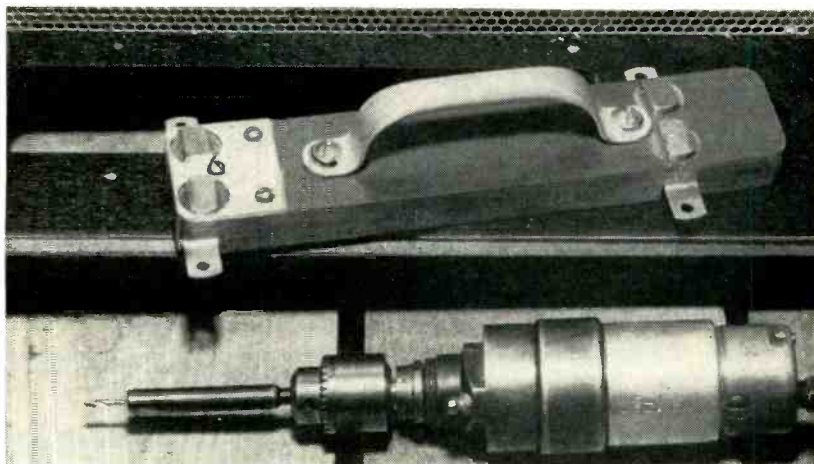

Magnetic gage used for holding two metal straps in correct positions for mounting across slot in front of cabinet, during drilling and driving of mounting screws

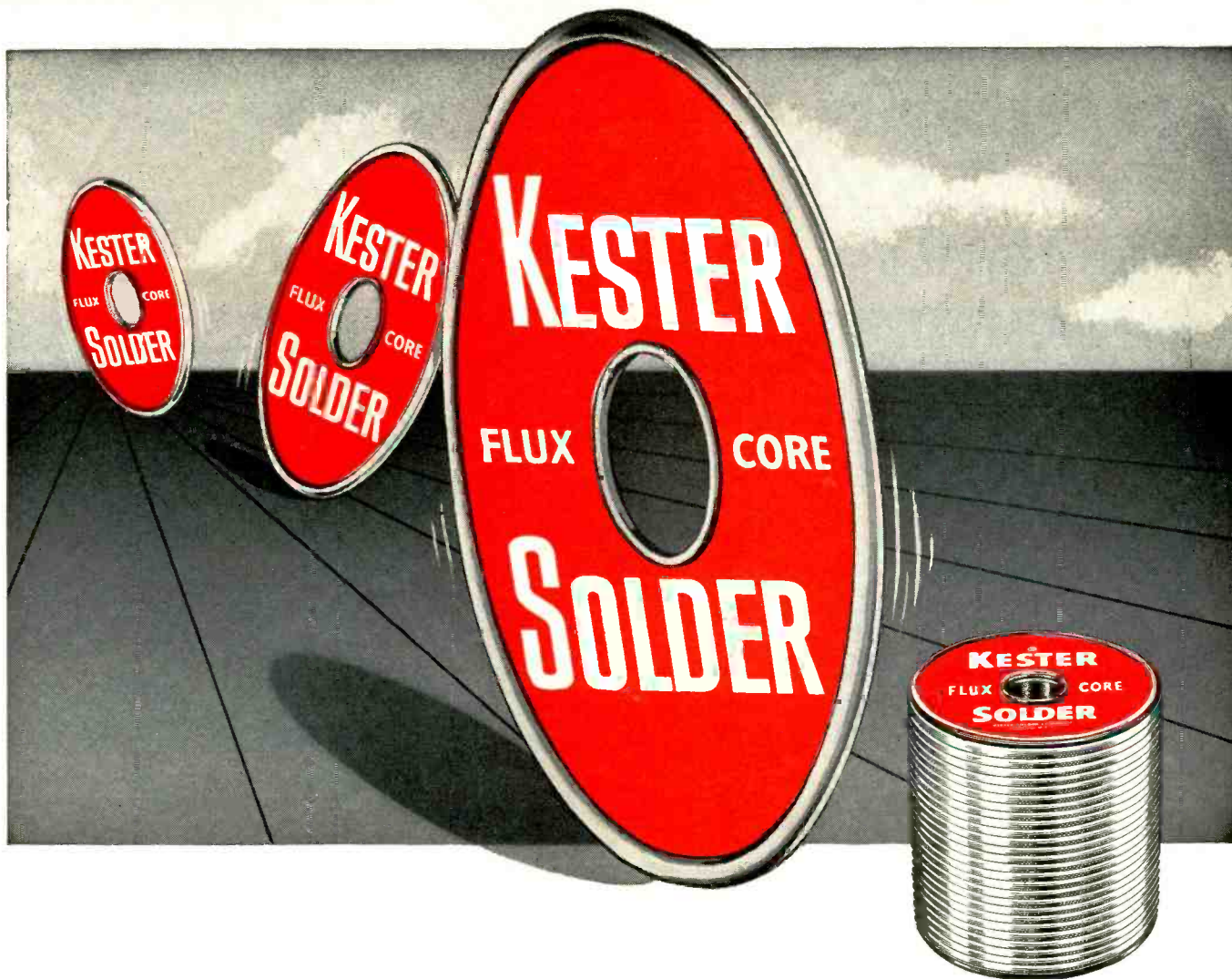

KEEPS 'EM ROLLING!



KESTER "44" Resin, Plastic Rosin and "Resin-Five" Flux-Core Solders keep the production lines moving by providing the exactly right solder for every application. Only virgin metals are

used in Kester . . . further assurance of the constant solder alloy control combined with consistent flux formulae . . . all part of Kester Flux-Core Solder quality that'll "keep 'em rolling" for you!

. . .

BE SURE YOU GET KESTER'S new 78-page informative textbook "SOLDER . . . Its Fundamentals and Usage."

KESTER SOLDER

COMPANY 4204 Wrightwood Avenue, Chicago 39, Illinois; Newark 5, N. J.; Brantford, Canada

magnets, then lowers the gage into the slot. With a drill chuck in an air gun and an appropriate size

drill set into a depth stop, he reaches down into the cabinet to drill the four holes. With another

air gun he then drives in the four mounting screws to anchor the brackets, then lifts out the gage.

Midget Train Delivers Cabinets to TV Assembly Line

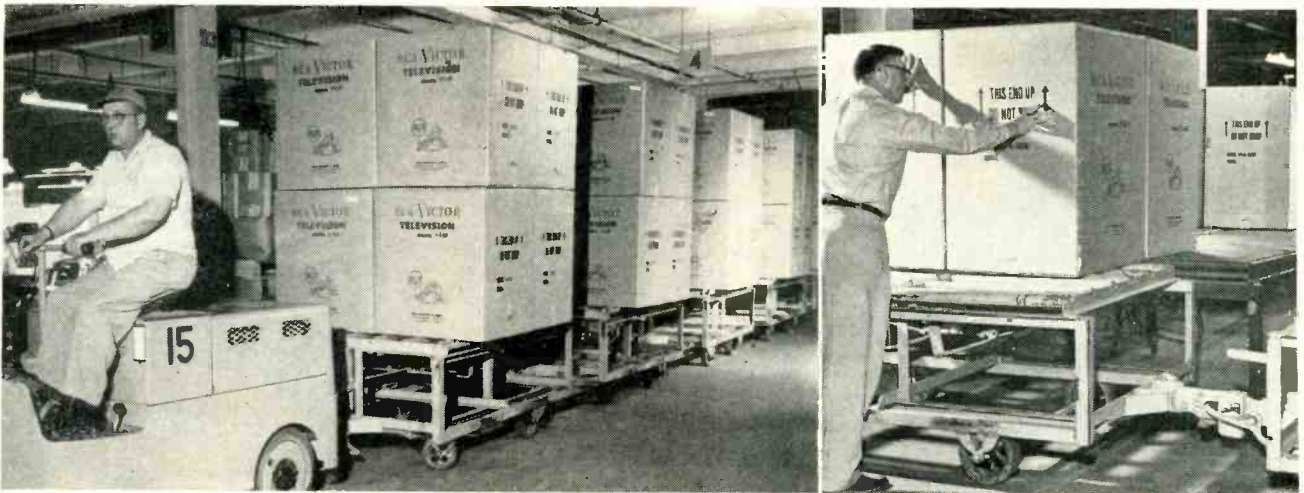

Pulling train-load of cabinets for 21-inch television receivers up to the ends of roller conveyor lines. Cars have double-layer loads of eight cabinets each

Pushing single-layer load of four cabinets off car onto two parallel roller conveyors

HIGH-SPEED assembly lines in RCA's Bloomington, Ind. plant are kept supplied with empty cabinets by a Mercury industrial truck hauling special roller-top cars that unload directly on the roller conveyors of the cabinet assembly lines. The cars are each large enough to hold four cabinets directly on the rollers. Four more can be placed on top of these while still clearing the overhead piping in the plant. A train of six

cars can thus bring 48 cabinets at a time.

To unload, the truck driver stops the train with the first car directly opposite the ends of a pair of conveyors. An assistant then releases the roller-locking lever on the car and pushes the entire load all at once onto the conveyor lines. The train is then advanced until the next car is in line and the process is repeated.

Braking of rollers on cars is achieved with two rubber-covered metal bars supported by levers that bring it up under the rollers on the car when the braking handle is pushed down.

The front wheels on the cars are pivoted, so they follow the tracks of the truck precisely even around sharp corners. The rolling equipment is made by Mercury Mfg. Co., 4044 South Halsted St., Chicago.

Card-Controlled Machine Makes Wrapped Joints Automatically

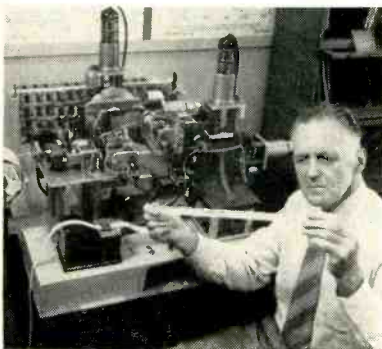

Examining punched tape used to control automatic wiring machine in background. Motor-driven wire-wrapping tool makes wrapped joints on terminals

A MACHINE that can automatically wire complex electrical apparatus by using solderless wrapped connections has been developed by R. F. Mallina of Bell Telephone Laboratories. Instructions are fed to the machine from a punched tape. Relays translate this information into electrical signals that control the cams and gears of the machine.

►How It Works—The experimental machine uses two rotating spindles. The wire is fed directly from a large spool. One spindle

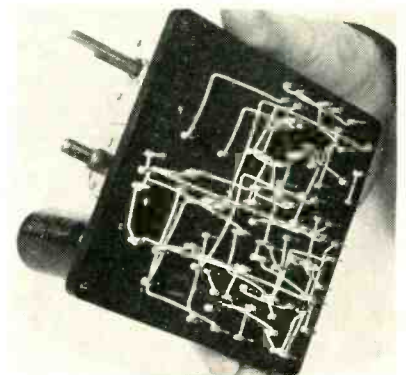

Bottom view of plastic panel for five-tube radio, showing solderless wiring put on by machine

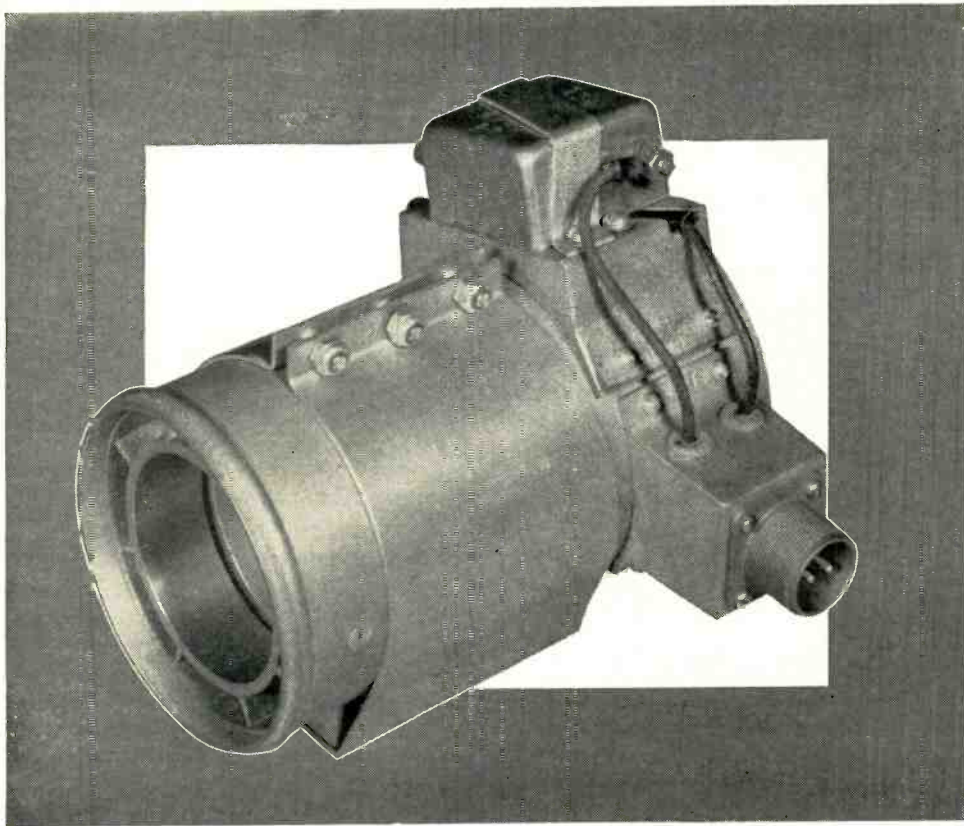

SPECIFICATIONS

Tubes Cooled
4X150A, 4X150G
5588 and 6161

Altitude
Up to 50,000'

Fan Model
Joy Axivane
AV-3.5-2.75-120D

Size
3 1/2" diameter

Weight
5 lbs.

Duty
60 CFM @ 5" WG

Motor
27V DC—4.7 Amps.

Only a JOY AXIVANE[®] FAN
can handle this Electronic Tube
cooling job at altitudes up to 50,000 feet

Cooling the above-specified tubes in airborne applications is a critical problem because of the extremely light air. The difficulty is particularly severe at elevations of 40,000 or 50,000 feet.

An extensive series of tests were recently initiated in an attempt to determine an effective cooling process. The tubes and sockets were mounted in pairs in a special cabinet designed to equalize the air distribution for each tube. The problem was to discover a method of heat dissipation that would hold the temperature of the glass-to-metal seals below the design operating level.

Of all the blowers tested, only this Joy AXIVANE fan was able to meet the rigid specifications. The tubes were cooled with 25°C air at an elevation of 50,000 feet, easily surpassing all requirements.

This is just one of an extensive line of AXIVANE fans specially designed for economical efficiency in cooling electronic equipment. All are built of aluminum and magnesium for light weight, sturdily constructed for maximum resistance to shock and vibration, and feature the space-saving compactness inherent in vaneaxial design.

Each fan can be modified to fit individual requirements for cooling all types of electronic equipment under any conditions. Let us help solve *your* problem.
 • Joy Manufacturing Company, Oliver Building, Pittsburgh 22, Pa. In Canada: Joy Manufacturing Company (Canada) Limited, Galt, Ontario.

Consult a Joy Engineer



W&I 5376

JOY

**WORLD'S LARGEST MANUFACTURER OF
 VANE-AXIAL TYPE FANS**

Designed for



Application

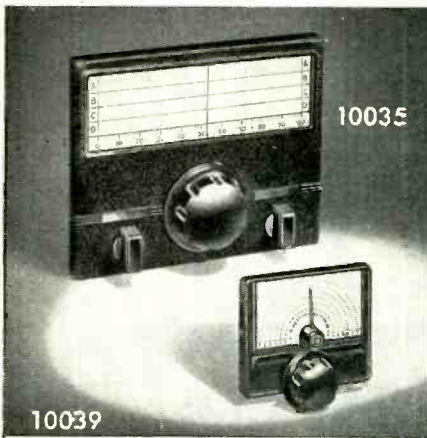

**Nos. 10035 and 10039
Multi-Scale Dials**

A pair of truly "Designed for Application" controls. Large panel style dial has 12 to 1 ratio; size, 8½" x 6½". Small No. 10039 has 8 to 1 ratio; size, 4" x 3¼". Both are of compact mechanical design, easy to mount and have totally self-contained mechanism, thus eliminating back of panel interference. Provision for mounting and marking auxiliary controls, such as switches, potentiometers, etc., provided on the No. 10035. Standard finish, either size, flat black art metal.

**JAMES MILLEN
MFG. CO., INC.**

MAIN OFFICE AND FACTORY
MALDEN
MASSACHUSETTS

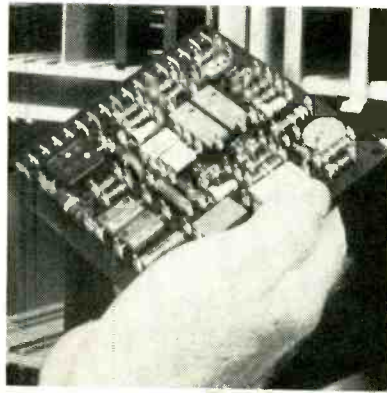

Top view of plastic panel, showing how leads of components are first anchored to solderless terminal pins

pulls the wire, in an inverted L-shaped movement, to a connecting terminal. At the same time the wire is cut to the correct length at the second spindle. The spindles remove a bit of insulation from

each end of the wire as they whip the bare wire ends around the terminals. This produces a pressure of about 15,000 pounds per square inch at each contacting area.

Following their punched tape instructions, the spindles then pick up the supply wire from the spool and move to the next electrical connection where the process is repeated. Machine wiring eliminates the need for preparing, storing and handling the many short pieces of wire.

The machine can be used in conjunction with plastic panels, all alike, on which are mounted different groups of electrical parts such as tubes, transistors, resistors and capacitors. The terminals of the parts protrude through holes in the panels spaced at regular (modular) intervals.

Wire-Coiling Dish for Cable Leads

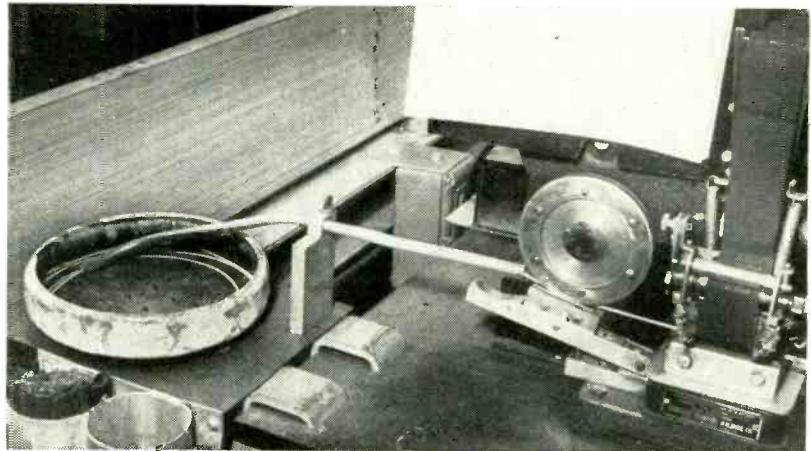

Wire coming from Kingsley printer is automatically coiled inside freely-rotating dish at left

INSULATED wire is automatically coiled as it speeds from an electronic wire measuring and stamping machine, by running the wire into a plastic laminate dish that is mounted on a bearing which permits it to rotate freely. This eliminates a time-consuming operation from the plug-assembly line. Cop-

per tubing guides the wire into the dish at the right angle to give smooth rotation without kinking the wire. The inside of the dish has straight sides so the wire can easily be lifted out after coiling. Wire-reinforced paper strips are then used for tying the coil, in the plant of The Glenn L. Martin Co.

Tote Rack for I-F Strips Loads Easily

TO MINIMIZE the need for reaching beyond a comfortable working position while transferring finished television i-f strips from a slide-along

line to a caster-mounted tote rack, only half the rack is loaded from one side. The operator then spins the entire rack around for loading

NOPCO[®] LOCKFOAM FOAMED PLASTIC

*... that finds an important new
function almost daily*

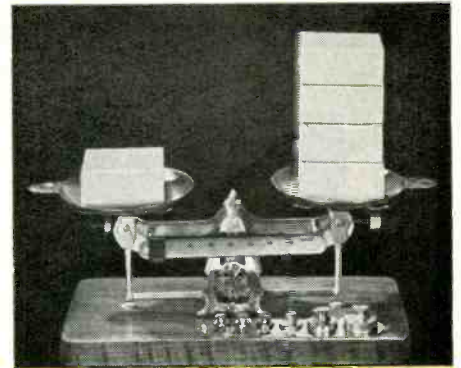
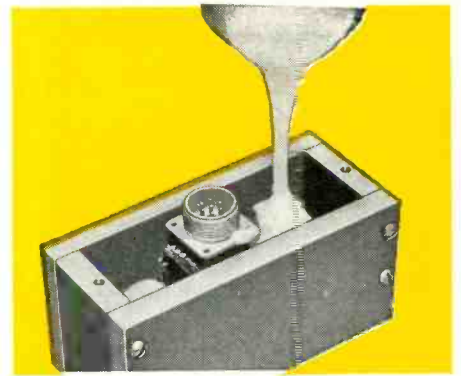

Choose your density

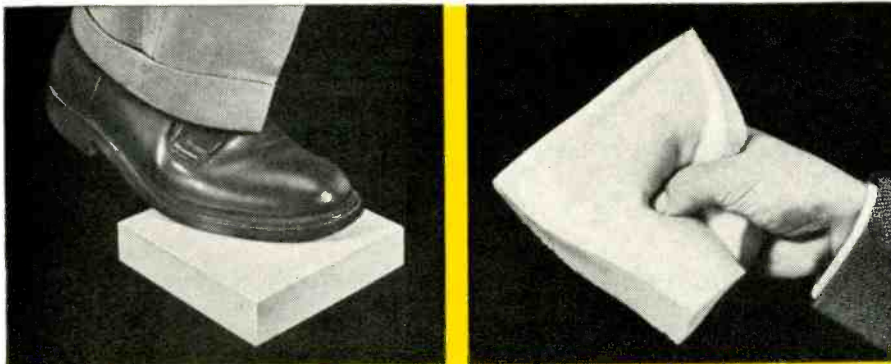

Rigid or flexible ... as you like

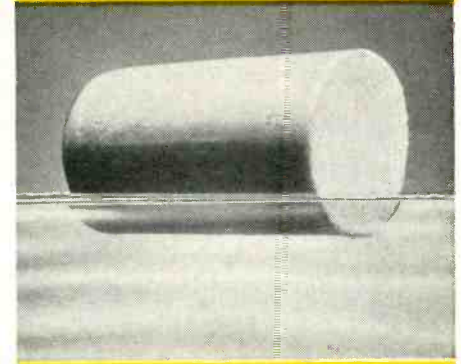

Resists moisture

**The properties we
can't illustrate are
at least as important
as those we can**

Near-perfect
Radar transmission

Ease of Fabrication
It's "poured-in-place"

Great Strength
with Light Weight

Wide Range of Densities
from 2 to 35 lb/cu ft

Good Thermal Insulation
"K" Factors
.018 at 8 lb/cu ft
to .025 at 11 lb/cu ft

Excellent Electrical Properties
6 lb/cu ft Lockfoam tested
at 9.375 KMC
Dielectric Constant 1.05
Loss Tangent .0005

Available in sheet form

Great versatility
50 different and
consistently reproducible
formulations available

**A few of Nopco Lockfoam's
present uses**

*Airplane Radomes,
Potting Electronic Instruments,
Reinforcing Automobile Doors,
Automobile Arm Rests, Packaging,
Shock Panelling, Instrument Cases,
Insulating Water Coolers and
Refrigerators, Cushioning,
Walls for Portable Units, Buoy.*

Our technical staff
will give you every assistance
in choosing among
Lockfoam's 50 different
formulations, and in making
its economies *your* economies.

*Write today for the
Nopco Lockfoam booklet.*

Nopco Chemical Company,
248 Stier St., Harrison, N. J.



PLASTICS DIVISION
HARRISON, NEW JERSEY
Los Angeles, Calif.



ALSO NEW!
 "Soft Wound" Spools
 insure delivery of even
 thin-wall tubing
 without flattening.

Resinite

NEW EP-69A

VINYL INSULATION
 SLEEVING
 for MIL-I-631B

simplify your vinyl sleeving requirements with one grade

FOR GENERAL PURPOSE USE

Brand new Resinite EP-69A embodies all the necessary properties for a "general purpose" insulation sleeving . . . good dielectric characteristics, oil resistance, a wide, effective temperature range and a satisfactory price.

FOR SPECIFICATION USE

Resinite EP-69A is designed specifically to exceed all requirements of specification MIL-I-631B. (Type F, Form U, Grades A and B, Class I and II, Category 1 and 2). It provides a working temperature range from -48°C to $+90^{\circ}\text{C}$ and a dielectric strength of 750 volts/mil. In addition, it is corrosion, fungus, oil and flame resistant beyond specifications.

Simplify your vinyl sleeving requirements with one grade—Resinite EP-69A. Write for samples and performance data.

Resinite
 RESIN INDUSTRIES, INC.
 Santa Barbara, Calif.

SPECIALISTS IN VINYL SLEEVING AND TUBING FOR THE AIRCRAFT, ELECTRONICS AND PHARMACEUTICAL FIELDS

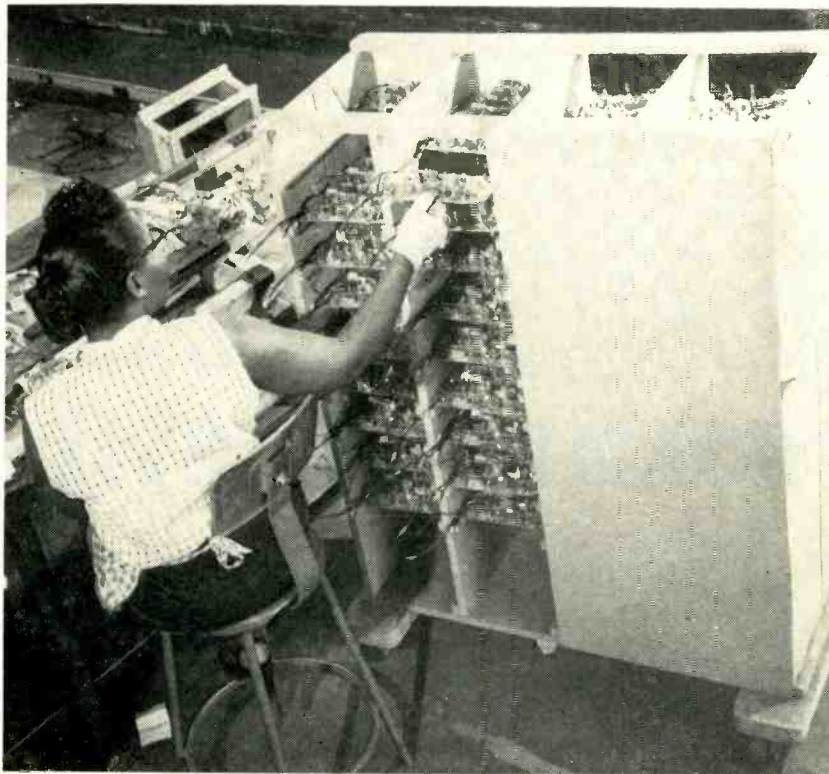

Method of loading tote rack with i-f strips for transport to main assembly line

the remaining half of the units.

The i-f strips are supported by wood cleats nailed to the vertical partitions, with each pair of cleats

holding four strips. The two bottom pairs of cleats are omitted, again to minimize operator strain and reduce fatigue.

Applying Varnish to Coil with Pressurized Hypo

AFTER assembly of ten-turn precision potentiometer windings on helical forms, a fillet of varnish is applied to one side of the element with high accuracy by means of a special setup in the Hicksville, N. Y. plant of Fairchild Controls Corp.

While observing the operation with the aid of a 20-power binocular microscope, the operator positions the varnish-applying hypodermic syringe at the start of the first turn, then rotates the potentiometer-holding arbor on a lead screw having the same pitch as the helix. An air line having a pressure of 5 lb per sq in. is attached to the end of the syringe, with the exact pressure being controlled by a foot-pedal throttle. The operator varies the pressure as required to get the varnish down between the coil and

the form without having any varnish reach the top part over which the contact wiper rides. The fillet varnish is mixed with a blue dye for added visibility during this



Anchoring turns of precision pot in core with varnish applied by hypo under air pressure

Take that **HEAT**
 out of the CHASSIS,
 by either of these methods...

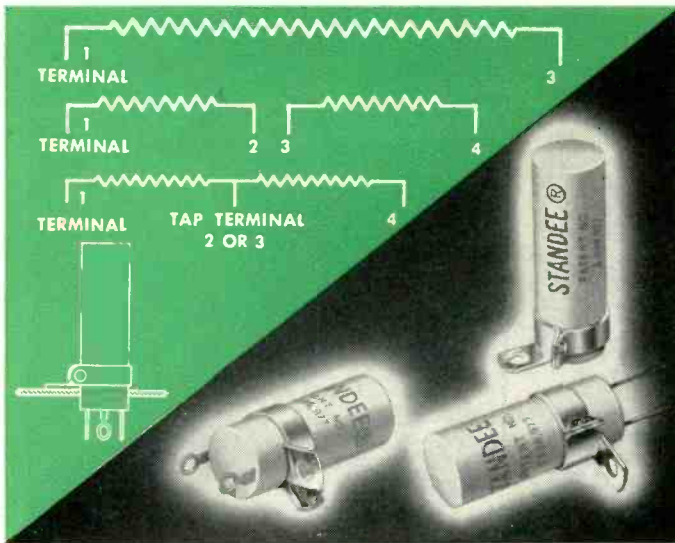

STANDEE*

Clarostat Series KS above-chassis-mounted power resistors. Handy terminals (lug, standard; or pigtail, at extra cost) for easy wiring. These unique components solve the problem of safe heat dissipation, yet terminals are below chassis, to fulfill UL requirements. Wire winding on glass fiber core, permanently sealed in smooth ceramic casing. Available in single, dual and tapped-section types as shown in wiring diagrams. Adjustable mounting ring provides for any protrusion above or below chassis. In 1½, 2, 2½ and 3" h. sizes. 10, 15, 20 and 25 watt ratings, respectively. Wide range of resistance values.

METAL-CLAD MOLDED

Clarostat Series MMR metal-clad resistors. Resistance winding sealed in molded phenolic and further protected by metal casing, for electrical and mechanical ruggedness. Adequate, but not excessive, phenolic insulation seals against moisture without hampering heat transfer to outer metal casing. No hot-spot troubles. Mounted flush against metal surface for maximum heat dissipation, unit is rated at 5 watts per winding inch, as against 2½ watts in free air. Sizes from 2" to 6" mounting centers. 1 to 10 sections. Breakdown strength over 1000 V.A.C.

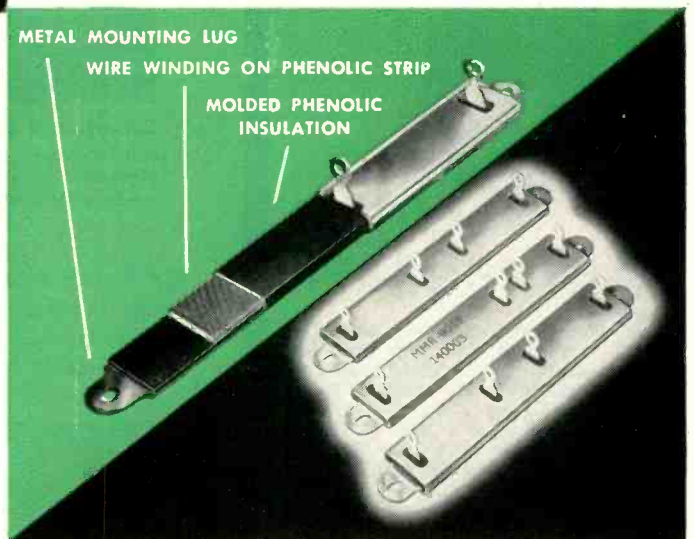

ASK FOR LITERATURE!

Engineering Bulletins sent on request. Let our resistor-specialists collaborate on your application problems. and let us quote.



*Reg. U. S. Pat. Off.

Controls and Resistors
CLAROSTAT MFG. CO., INC., DOVER, NEW HAMPSHIRE
 In Canada: Canadian Marconi, Co., Ltd., Toronto 17, Ont.

critical procedure.

The potentiometer arbor has a notch in which the attached leads

fit, to keep them out of the way and thereby prevent breakage of leads as the core is rotated.

Quick-Release Clamps Pull Chassis Dollies

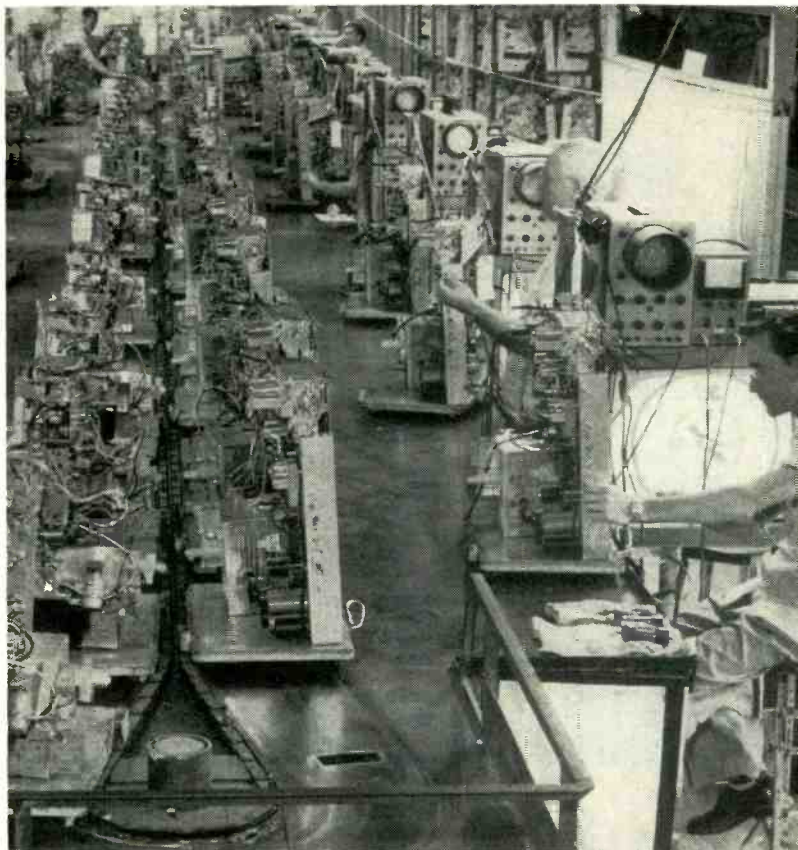

Conveyorized color-tv test line. Dollies travel clockwise around bend in foreground. Brushes under one dolly sweep the table continuously and push scraps down through rectangular hole in table at right foreground. On this line, tests are made with black-and-white Indian-head test pattern

AN ENDLESS horizontal chain conveyor running down the middle of a wide metal-top table keeps RCA 26-tube color tv receivers circulat-

ing on dollies past test positions on both sides of the table, in the firm's Bloomington, Ind. plant.

When work on a chassis is finished at one of the test positions, the operator pushes its dolly up into an empty space on the conveyor. A U-shaped metal clamp on the dolly automatically engages with the next pin on the conveyor chain.

A loosely mounted metal ring and transverse pin on the clamp act together to prevent the dolly from rolling past the pin under its own momentum when the conveyor is stopped for any reason. Any operator can stop the conveyor simply by standing up to tug the plastic clothesline strung over the test positions on both sides and anchored to the conveyor stop switch.

To take a dolly off the line, the

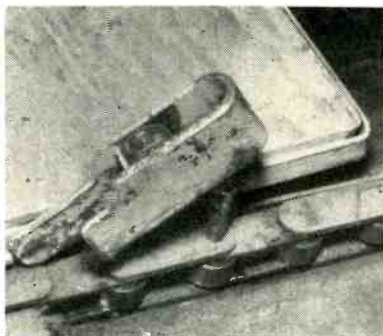

U-shaped clamp on dolly is here in raised position for pulling dolly off stud of chain conveyor. Metal band inside clamp prevents dolly from coasting past stud under its own momentum when conveyor is stopped

70 mm.

for

one

millivolt

yet drift-free

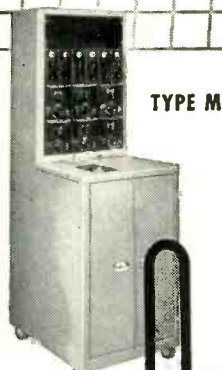

TYPE M

THE OFFNER DYNOGRAPH

0.001 volt input d-c gives 70 mm. deflection with this high-speed direct writing oscillograph, many times that for competitive units. The Dynograph with one amplifier is used for all types of inputs for measuring speed, temperature, position, vibration, and other variables. Patented, chopper amplifier design makes it sensitive, stable, and versatile. Available in both 6 channel console model and single and dual channel portable models. Get bulletin L742—compare the Dynograph with all competitive models—it combines sensitivity with absolute stability.



OFFNER ELECTRONICS INC.

5324 N. Kedzie Avenue
Chicago 25, U. S. A.

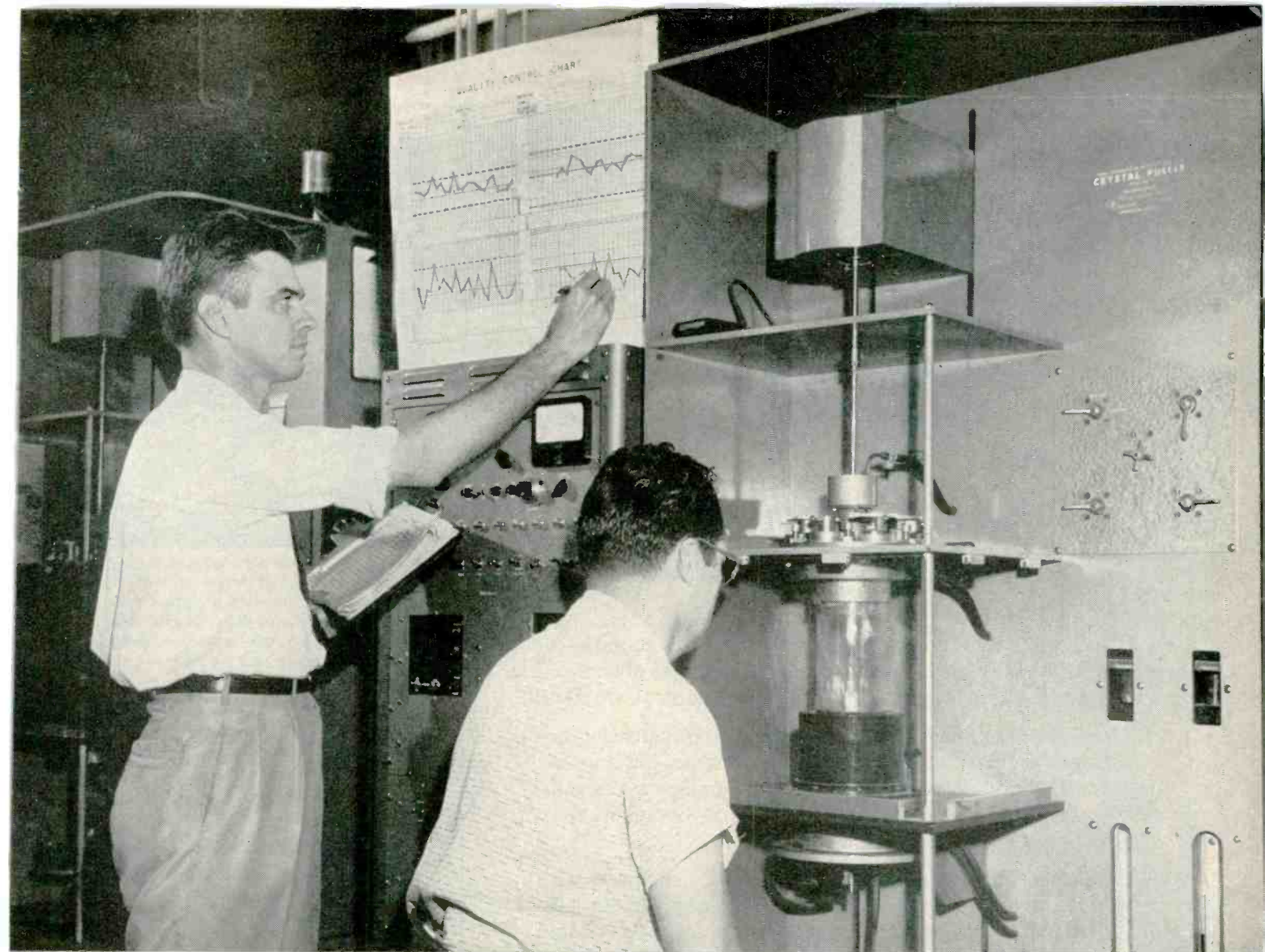

CLOSE PARAMETER CONTROL MEANS

TI transistors standardize your production circuits!

YOU CAN NOW DESIGN transistorized circuits to standard device specifications. Texas Instruments *controlled parameter* semiconductor devices fit your specific applications without additional testing and selection. Parameter tolerances are closely held and accurately described in new comprehensive design data. All TI germanium and silicon transistors are manufactured and 100 per cent tested for exacting design characteristics.

This close parameter control has enabled Texas Instruments to pace the industry in transistor development and application. Newest TI germanium devices are n-p-n high speed switching transistors. An important step toward complete transistorization of computers, these grown junction units have beta spreads of two-to-one and are 100 per cent tested for switching characteristics. TI was also first to produce silicon transistors commercially, and *only* TI manufactures germanium transistors for *all* three transistorized pocket radios now on the consumer market. For radio, general purpose, and many specific applications, Texas Instruments manufactures both p-n-p alloyed junction and n-p-n grown junction germanium types.

For your own transistorized product development, specify the exact devices you need from TI's wide range of semiconductor products — germanium and silicon; p-n-p or n-p-n types; diodes, triodes, tetrodes. Write for new descriptive data and curves that will help simplify your production problems.

TEXAS INSTRUMENTS
INCORPORATED

6000 LEMMON AVENUE DALLAS 9, TEXAS



SEND THE COUPON FOR DETAILS

Please send comprehensive data and curves describing the semiconductor products checked below:

GERMANIUM

- Radio transistors, p-n-p and n-p-n types
- High speed switching transistors
- P-N-P alloyed junction general purpose transistors
- N-P-N grown junction general purpose transistors
- Phototransistors
- Grown junction tetrodes

SILICON

- General purpose transistors
- Power transistors
- Junction diodes
- Voltage reference diodes

Name _____

Company _____

Address _____

Semiconductor Engineers and Scientists

GENERAL MOTORS offers exceptional opportunities in this field as a result of newly expanded programs of research and development—and now, pilot plant production.

These are permanent programs of great and increasing importance to General Motors in its electronic, automotive, aircraft engine, locomotive, household appliance and military activities—not just temporary study or short-term development programs.

Physicists, physical chemists and electronic engineers with baccalaureate or advanced degrees and those with transistor, diode, photo-cell, other semiconductor and related experiences in research, development or process and production will find:

- Important, interesting and challenging problems
- Modern facilities
- Congenial association with others skilled in these sciences

Resulting in maximum personal satisfaction, development and recognition.

Upper-level positions for those shown to qualify.

The unusual employe benefits of General Motors are provided by this 20-year-old GM electronics division. Relocation expenses are paid. Pleasant Indiana community with excellent living conditions, schools and many other advantages. Letters held in complete confidence. Give information on education, experience, military duty and personal data.

Address: Personnel Director, Department MM

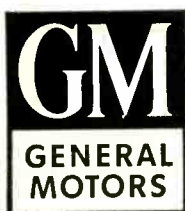

Delco Radio

DIVISION OF

GENERAL MOTORS

KOKOMO, INDIANA



Method of mounting table-sweeping brooms under one of dollies on color-tv test line. Wood handles of broom project up above top of dolly through cut-out slots, hence the sweeping dolly does not normally carry a chassis

operator presses down the handle projecting from the front of the dolly. This raises the U-shaped clamp from the conveyor stud so that the dolly can be pulled into the test position. The color chassis is heavy enough to rest directly on the ball-bearing dolly, without need for hold-down clamps.

Plastic clothespins are used to indicate the test status of each chassis. A clothespin at the upper left side of the chassis signifies that it is ready for test, having been just



Test position on color-tv alignment line, showing special test plug used for feeding picture carrier and r-f sweep signals into elevator coil at input of tuner, for aligning tuner to i-f strip



research*



development



design



production



A SUBSIDIARY
OF HOFFMAN
ELECTRONICS
CORPORATION

INTEGRATED ELECTRONICS

THE IMAGINATION FOR RESEARCH PLUS
THE SKILLS FOR PRODUCTION

Performance in the field is the real test of product worth. To maintain Hoffman's reputation for high standards of quality and performance, Field Engineers are constantly performing direct, on-the-spot aid in installation, operation, and evaluation of Hoffman electronic equipment.

Hoffman Field Engineers are chosen from the engineering design and test groups for their specialized knowledge and ability. These specially trained, specialized engineers carry the integrated skills of research, development, design, and production into the field . . . wherever Hoffman equipment is being used . . . on land, air, sea, or undersea.

Typical of the types of projects Hoffman Field Engineers are working on, one group is presently engaged in conducting field evaluation studies at remote air bases on TACAN, the most advanced airborne navigation equipment yet produced. This field study is being coordinated with Hoffman's production of TACAN equipment.

NUMBER 4 OF A SERIES



Radar, Navigational Gear
Missile Guidance & Control Systems
Noise Reduction
Countermeasures (ECM)
Communications
Transmission Applications

CHALLENGING OPPORTUNITIES FOR OUTSTANDING ENGINEERS TO WORK IN AN ATMOSPHERE OF CREATIVE ENGINEERING. WRITE THE DIRECTOR OF ENGINEERING, HOFFMAN LABORATORIES, INC., 3761 SOUTH HILL STREET, LOS ANGELES 7, CALIFORNIA.

What looms ahead on

your design horizon?

When specifications call for

RESISTANCE ALLOYS
— consult **WILBUR B. DRIVER**

For Wilbur B. Driver engineers are resistance alloy specialists. Over the last 25 years, the laboratories and production divisions have encountered, and solved, many unusual and difficult applications involving the use of electrical, electronic, mechanical and chemical alloys. This broad experience is available to assist you in working out your designs and specifications. Why not contact a Wilbur B. Driver sales engineer for assistance on special alloys, today!

WIRE, ROD, RIBBON and STRIP

All forms of resistance alloys available for all applications in the electrical and electronic fields. Insulations to specifications including enamel, cotton, silk, nylon and glass.

Alloys of Proven Performance for —

- ELECTRICAL APPLIANCES
- BALLASTS
- ELECTRIC FURNACES
- ELECTRIC RANGES
- ELECTRON TUBES
- GLASS-TO-METAL SEALS
- HIGH TEMPERATURE AIRBORNE EQUIPMENT
- NUCLEONICS
- POTENTIOMETERS
- RADIANT HEATERS
- RESISTORS
- RHEOSTATS
- SENSING BULBS
- SOLDER GUNS
- SOLDERING IRONS
- HIGH AND LOW TEMPERATURE COEFFICIENTS

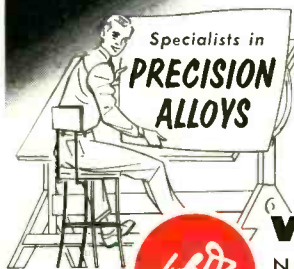

Wilbur B. Driver Co.
NEWARK 4, NEW JERSEY

For Over A Quarter Century Manufacturers of Dependable Electrical, Electronic, Chemical and Mechanical Alloys

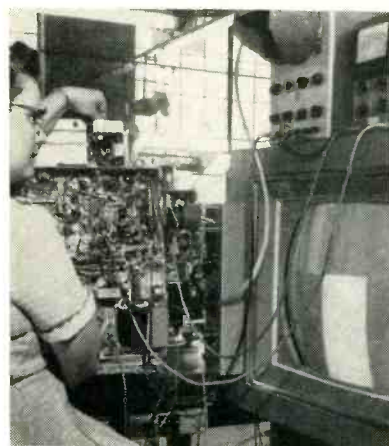

Video test position, utilizing color-bar-generator pattern on 21-inch round color tube in test cabinet at right. Operator here makes seven connections to chassis on dolly: 1—plug kinescope cap of set into top socket of vertical box at left of picture tube; 2—plug convergence leads of set into next lower socket; 3—plug in yoke leads; 4—attach lead of regulator current meter (above picture tube) to under-chassis terminal and attach other meter lead to chassis, then attach another lead to run B plus back to set from yoke so as to jump around fuse; 5—plug in line cord; 6—feed color-bar signal into elevator coil of tuner through plug; 7—connect heavy braided metal ground strap to chassis

put on the conveyor or having gone through a troubleshooting and repair position on the line. A clothespin at the lower left on the chassis means it has tested OK and is ready to be placed on an overhead conveyor for transfer to the i-f test and alignment line. A clothespin at the upper right signifies the need for troubleshooting.

This recirculating conveyor system has proved particularly successful during the early stages of bringing a new color television line up to speed. The sets can be run around the conveyor line and in and out of test and repair positions as often as necessary without interfering with the flow of production, as long as the average output of the test lines approximately matches that of the assembly lines.

Life Test Setup

PRECISION potentiometers are run through millions of operating cycles on a unique universal test stand in the Hicksville plant of Fairchild Controls Corporation. A special

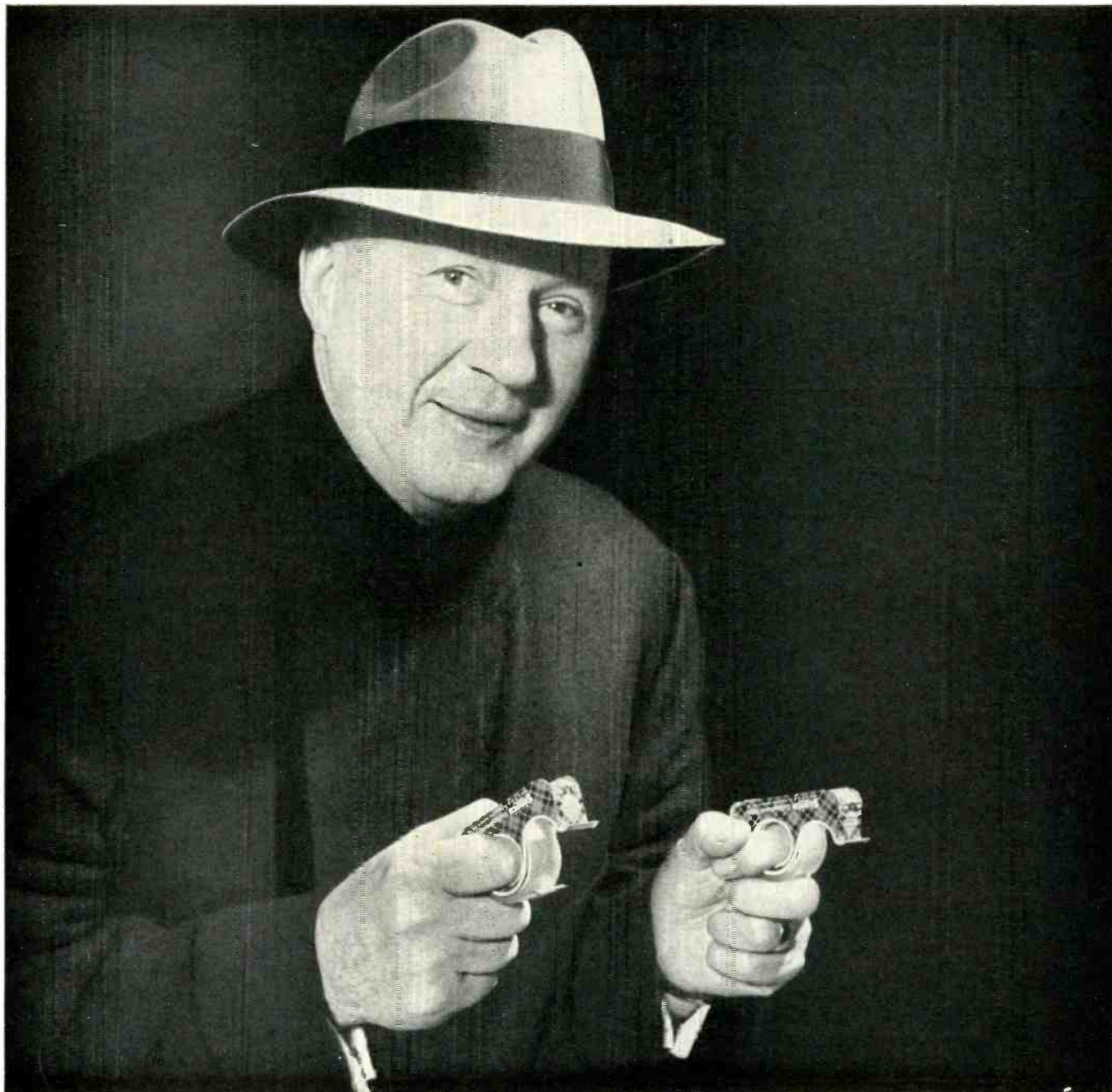

At Minnesota Mining and Manufacturing Company (known as "3 M"), they say,

"He's America's No. 1 stick-up man!"

"Need a 'Scotch' brand tape for grafting trees? Wrapping a new automobile? Splicing a rug?

"We have 'em — and hundreds more," says "3 M" Executive Vice-President L. F. Weyand. "No wonder they call me the 'stick-up man.'"

"But there's one kind of sticky tape you won't find around here, and that's *red* tape. When our dealers or customers ask for a shipment in a hurry, we take them at their word.

"We call Air Express — and the shipment is delivered in a matter of hours!

"We know we can depend on Air Express. We prove it hundreds of times a year. What's more, we *save money* by using Air Express. A 25 lb. shipment from St. Paul to Miami, for example, costs \$13.65 door to door (one charge). That's 20¢ less than *any* other air carrier — and the service just can't be compared!"



Air Express



GETS THERE FIRST via U.S. Scheduled Airlines

CALL AIR EXPRESS . . . division of RAILWAY EXPRESS AGENCY

NEW MINIATURE

12-position Multipole Rotary Switch

- **Small size** — only $\frac{3}{4}$ inch square.
- **Light weight** — one-half ounce.
- **Versatile circuitry** — contact arrangements from 1-pole 12-position, to 3-pole 4-position for a single deck.
- **Ganged assembly** — up to six decks can be combined for single-knob operation.
- **Current-carrying capacity** — capable of carrying 3 amperes without excessive temperature rise.
- **Interrupting capacity** — 0.5 amperes, non-inductive, at 125 volts 60 cps.
- **Electrical life** — 250,000 operations.
- **Voltage rating** — 125 volts a-c.

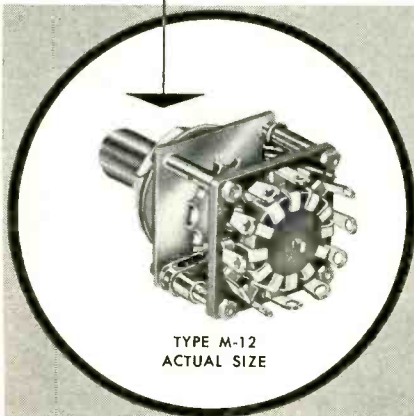

*Here is the switch
that meets these
specifications*

- **Breakdown voltage** — between live parts or to ground — over 1000 volts RMS at 60 cps.
- **Insulation resistance** — 1000 + megohms. All insulating parts meet specification MIL-P-3115B, MIL-P-15037B, or MIL-I-3190.

R-F ELECTRONICS, inc.

DIVISION OF ELECTRO SWITCH CORPORATION

Weymouth 88, Massachusetts

heavy metal grille serves as the base, on which are mounted the support brackets for the potentiometers and the supports for the drive shafts. The shafts are linked together by gears which in turn are driven through a reduction drive by a small electric motor.

Switches give the option of continuous rotation or back-and-forth oscillation. A strip of sheet metal is fastened over the gear chain to prevent objects from falling in and jamming, since the unit runs unattended for many days.

Linotype Slugs Identify Wires

MARTIN has added a Linotype machine to its aircraft manufacturing equipment. In today's aircraft, electrical and electronic systems use thousands of wires of many different types, each of which must be coded by a printed number every few inches of its length. Linotype identifies these wires with sharp, clear characters. New slugs are cast for printing each specific lot of wires. This replaces movable type, which required hand setting and constant replacement due to wear.

Terminal Plug Holder

PLUGS for the connecting cables of the Matador guided missile are wired five at a time with the aid of a holding fixture in the Baltimore plant of The Glenn L. Martin



Assembling plugs with aid of universal holding fixture

1. The **SEEING EYE** of industry. This simple Image Dissector tube is used in the Utiliscope, a closed circuit industrial TV, made by Diamond Power Specialty Corp., Lancaster, Ohio. It eliminates filament and electron gun. For dependability and assurance of long life, most of the internal components are Inconel, a high nickel-chromium alloy.

*Why "Diamond" uses
Inconel parts in*
**Simplified
Industrial TV
Pick-Up Tube**

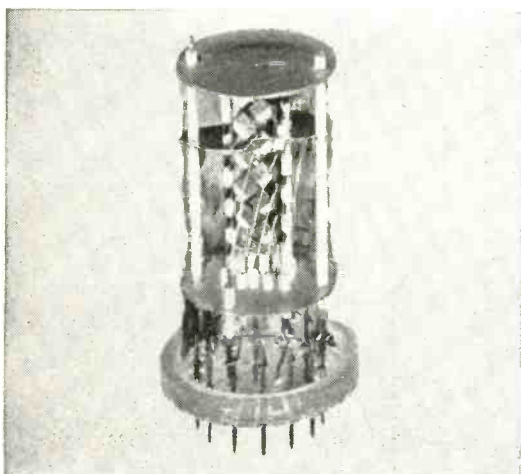

2. This electron multiplier increases the signal of the Image Dissector tube two to six million times through a series of eleven silver-magnesium cups on Inconel holders. Diamond designers found that Inconel is the only satisfactory metal for all but a few of the electron multiplier's 150 parts.

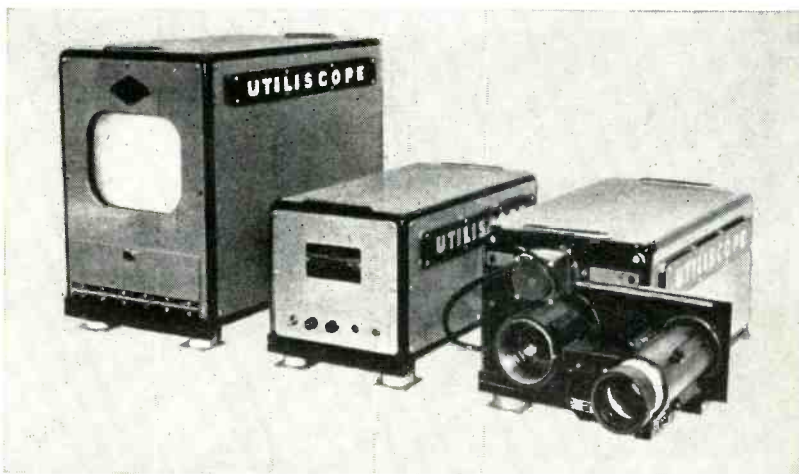

3. When an engineer says, "Let's look into it," he may mean this "Utiliscope" industrial TV. It takes a steady look at places the eye can't reach... places too hot or highly radio-active for people to watch.

Light falling on the face of the Image Dissector tube liberates electrons from the special surface of the photocathode. Some of these tubes are still being used after more than four years of service.

Here's why most of the internal parts of Diamond's dependable, long life Image Dissector tube are made of Inconel:

Inconel is non-magnetic, even after being cold-worked. It is easy drawing. Spot welds excellently. Can be easily cleaned and kept clean to avoid gas formation. It remains strong and stiff when heated for degasification. *And, when all costs are considered, it's less expensive.*

Inco Nickel Alloys for Electronic Uses is the title of a booklet that may suggest where the useful properties of

Inconel or one of the other Inco Nickel Alloys can solve a design or fabrication problem for you. Write for it, today.

THE INTERNATIONAL NICKEL COMPANY, INC.
67 Wall Street
New York 5, N. Y.



MONEL® • "R"® MONEL • "K"® MONEL • "KR"® MONEL
"S"® MONEL • INCONEL® • INCONEL "X"®
INCONEL "W"® • INCLOY® • NIMONIC® Alloys
NICKEL • LOW CARBON NICKEL • DURANICKEL®

VLF

... VERY LOW FREQUENCIES

*radio
interference
and
field
intensity**

MEASURING EQUIPMENT



Stoddart RI-FI meters cover the frequency range 14kc to 1000 mc

HF

NM-20B, 150kc to 25mc

Commercial Equivalent of AN/PRM-1A. Self-contained batteries. A.C. supply optional. Includes standard broadcast band, radio range, WWV, and communications frequencies. Has BFO

VHF

NM-30A, 20mc to 400mc

Commercial Equivalent of AN/URM-47. Frequency range includes FM and TV bands

UHF

NM-50A, 375mc to 1000mc

Commercial Equivalent of AN/URM-17. Frequency range includes Citizen's band and UHF color TV band.

Stoddart NM-10A

14kc to 250kc

Commercial Equivalent of AN/URM-6B

VERSATILITY . . . The NM-10A is designed to meet the most exacting laboratory standards for the precise measurements, analysis and interpretation of VLF radiated and conducted radio-frequency signals and interference. Thoroughly portable, yet rugged, the NM-10A can be supplied with accessories to fulfill every conceivable laboratory and field requirement.

EXCELLENT SENSITIVITY . . .

The NM-10A sensitivity ranges from one microvolt-per-meter to 100 microvolts-per-meter, depending upon whether rod or shielded loop antennas or line probe are used.

ACCURACY . . . Each equipment is "hand calibrated" in the Stoddart Test Laboratories by competent engineers. This data is presented in simplified chart form.

DRIPPROOF . . . Sturdy dripproof construction allows long periods of operation in driving rain or snow without adverse effects.

FLEXIBLE POWER REQUIREMENTS . . . The ac power supply permits operation from either 105 to 125 volts or 210 to 250 volts ac, at any frequency between 50 cps and 1600 cps.

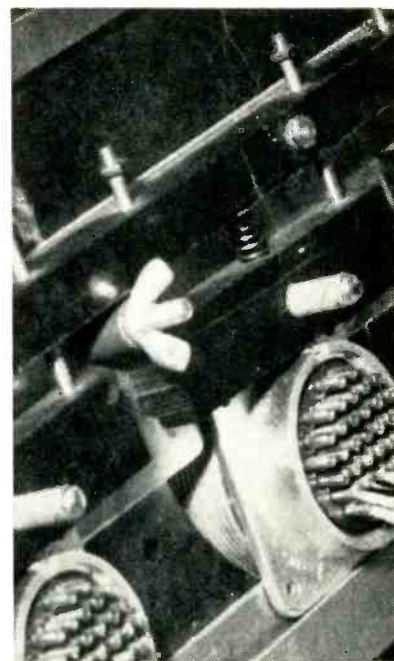

Details of holding fixture. Wing nut can be loosened to slide under strip up or down to accommodate different sizes

Co. Adjustable legs hold the fixture at the optimum angle for assembly. Aluminum channels and transparent sheet plastic windows form pockets on the upper half of the fixture for supporting standard 8½ × 11-inch assembly prints.

Controlling Sludge in Etched Wiring Bath

By L. J. MARTIN and M. J. VAVRA
*Weapon Systems Development
Laboratories
Hughes Aircraft Co.
Culver City, Calif.*

ELECTROLYTIC conduction is the chief source of leakage in etched circuits. Electrolytic leakage results from the combined presence of moisture and ionizable contaminants.

Scattered evidence suggested that ferric-chloride contamination varied during the life of an etching bath. Consequently, modified ASTM patterns of Fig. 1 were etched in batches of four on boards cut from a single sheet at intervals until the etchant was considered to be exhausted. Samples of the etchant were taken as each batch was etched. All etched boards were cleaned as uniformly as possible by hand-scrubbing with hot water and detergent. When dry, the average surface and volume resistivities of each batch were high and reason-

STODDART aircraft radio co., inc.
6644-A SANTA MONICA BLVD., HOLLYWOOD 38, CALIFORNIA · HOLLYWOOD 4-9294

NOW AVAILABLE!

SUPER-RUGGED!

ADVAC

HIGH VOLTAGE TERMINALS

Specify ADVAC High
Voltage Terminals for:

JET ENGINE THERMO-
COUPLE SEALS
FIRE DETECTION AND
TEMPERATURE CONTROLS
EXPLOSION PROOF
ASSEMBLIES
REFRIGERATION
COMPRESSOR SEALS
KLYSTRON OUTPUT
WINDOWS
T-R TUBE WINDOWS
IGNITION INSULATOR
BUSHINGS
VACUUM TUBE CLOSURES
HEATING ELEMENT
TERMINATIONS
NUCLEAR ENERGY
EQUIPMENT
IMMERSION HEATER SEALS
POWER CABLE END SEALS
CHEMICAL RESISTANT
INSULATORS
HEAVY-DUTY TRANSFORMERS
CAPACITORS
PULSE NETWORKS
RELAYS, DELAY LINES
FILTERS, REACTORS
MOTOR SWITCHES

- **Pure silver brazed for
higher temperature service**
- **Helium mass spectrometer tested
for vacuum-tightness**
- **High mechanical strength
and thermal shock resistance**
- **Adaptable for soft-soldering,
brazing or welding**

New ADVAC High Voltage Terminals withstand operating temperatures of over 1000°F. They have been service-proven in a wide range of applications where severe environmental conditions, including both mechanical and thermal shock, are encountered. ADVAC super-rugged high voltage terminals are available in nine economical standard types that meet most requirements. For special applications, custom terminals can be produced to your exact specifications.

—For Critical
Commercial
and Military
Applications



Call or Write
for Illustrated
Catalog

DIVISION OF
GENERAL CERAMICS
CORPORATION



**ADVANCED VACUUM
PRODUCTS • INC**

18-22 Liberty Street, Stamford, Connecticut—Telephone: Davis 4-2148

HIGH TEMPERATURE, VACUUM TIGHT CERAMIC-TO-METAL SEALS FOR THE ELECTRONIC INDUSTRY

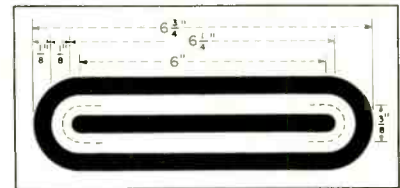
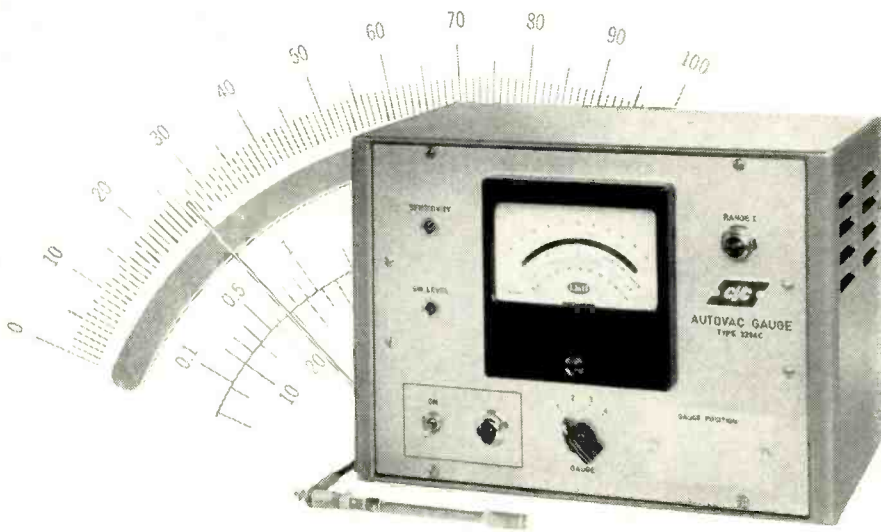

FIG. 1—Modified ASTM guard ring pattern used in troubleshooting the production of etched wiring boards

Introducing the **AUTOVAC** vacuum gauge . . . changes range automatically

This remarkably sensitive, hot-wire type vacuum gauge gives continuous pressure readings from 100 millimeters Hg to 1 micron Hg.

Switching from the millimeter range (100 to 0.1mm Hg) to the micron range (100 to 1 micron Hg) is completely automatic.

The Autovac gauge has a higher degree of calibration stability than any other gauge of its type.

- Illuminated panel light tells you at a glance when the pressure is in the millimeter range.
- Automatic range changer is adjustable between 10 and 2500 microns.
- Accessory relay provides automatic activation of external circuits.
- Supplied with one, two, three, or four stations.
- There is no question as to location of each station in the system—you note this on the panel under "Gauge Position."

Consolidated Vacuum Corporation is the authorized dealer in the United States for the Autovac vacuum gauge manufactured by LKB-Produkter, Stockholm, Sweden. A complete stock of gauges, accessories, and spare parts is now available from CVC. For further information, write for your copy of CVC data sheet No. 9-25.

Specifications

Power Supply 110, 130, 150, 220, 240 volts; 50/60 cycles
 Dimensions 12 1/4" x 6 3/4" x 8 1/2"
 Net Weight 17 lbs.



Consolidated Vacuum Corporation Rochester 3, N. Y.
 a subsidiary of CONSOLIDATED ENGINEERING CORPORATION, Pasadena, California
 CVC sales now handled through Consolidated Engineering Corporation with offices located in: Albuquerque • Atlanta • Boston • Buffalo • Chicago • Dallas • Detroit • New York • Palo Alto • Pasadena • Philadelphia • Seattle • Washington, D. C.

ably uniform, as shown in Fig. 2.

Tremendous resistivity variations showed up following humidity exposure. These variations followed a systematic trend from batch to batch, as indicated by the dashed lines in Fig. 2. The fact that resistivities deteriorated, then improved and deteriorated again was puzzling until these results were correlated with the history of this etching bath. Batch 10, the first to show this improvement, followed a rest period while batch 12 was etched at the start of work the following day. These improvements following rest suggested sludge as the important contaminant, since sludge settled when the bath was not used.

Examination of the etchant samples corresponding to each batch of boards showed a yellowish-brown precipitate, the amount of which varied inversely with the wet resistivities of each batch. Analysis of the sediment showed it to be primarily a complex mixture of filterable copper and iron oxides. The particles seemed to be porous and to be saturated with copper and iron salts in all stages of oxidation.

► Sludge-Preventing Procedure—

Further correlation of sludge formation and etchant exhaustion with specific gravity and hydrogen-ion tests caused the following picture to take shape. Initially, there is no sludge and hence no sludge contamination. With continued use of a bath, sludge is formed and contamination of the board increases. A fresh bath with 23 deg Baume has a pH of about 0.5 which increases as the bath is used. When a pH of approximately 0.85 to 0.90 is reached, sludge formation becomes noticeable and results in contamination of the board. If the ferric-chloride bath is operated be-



SIZE
1-1/16 OD
1/2 H
6-32 MTG.

TYPES	Q max.	Freq.
MP206	140	14 KC
MP848	185	35 KC
MP608	170	60 KC
MP073	265	250 KC



SIZE
1-5/16 OD
23/32 H
6-32 MTG.

TYPES	Q max.	Freq.
MP930	160	8 KC
MP395	225	25 KC



SIZE
2 OD
1 H
8-32 MTG.

TYPE	Q max.	Freq.
MP254	210	6 KC

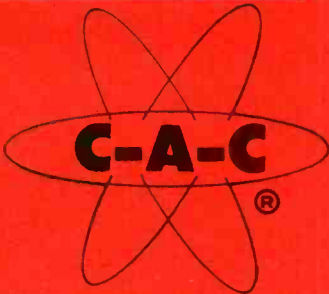

C-100

TOROIDS - PLASTIC MOLDED

Now Less Cost Than Bare Unprotected Equivalents

MP (Molded Plastic) units are the result of a long development program. CAC MP toroids have repeatedly passed all tests for MIL-T-27, Grade 1, Class A without exception. Most compact design—may be stacked—mounted by center bushing—absorbs mounting pressures—sturdy plated terminals—standard inductance values listed below shipped from stock—complete Q versus frequency data at your request.

MOLDED AND CASED TOROIDS CARRIED IN STOCK

(Order by Part Number)

MP206		MP848		MP930		MP395		MP254	
IND.	PART. No.	IND.	PART. No.	IND.	PART. No.	IND.	PART. No.	IND.	PART. No.
5.0 MH	MP-206-1-	2.0 MH	MP-848-1-	5.0 MH	MP-930-1-	5.0 MH	MP-395-1-	20 MH	MP-254-1-
6.0 MH	MP-206-2-	2.4 MH	MP-848-2-	6.0 MH	MP-930-2-	6.0 MH	MP-395-2-	24 MH	MP-254-2-
7.2 MH	MP-206-3-	3.0 MH	MP-848-3-	7.2 MH	MP-930-3-	7.2 MH	MP-395-3-	30 MH	MP-254-3-
8.6 MH	MP-206-4-	3.6 MH	MP-848-4-	8.6 MH	MP-930-4-	8.6 MH	MP-395-4-	36 MH	MP-254-4-
10 MH	MP-206-5-	4.3 MH	MP-848-5-	10 MH	MP-930-5-	10 MH	MP-395-5-	43 MH	MP-254-5-
12 MH	MP-206-6-	5.0 MH	MP-848-6-	12 MH	MP-930-6-	12 MH	MP-395-6-	50 MH	MP-254-6-
15 MH	MP-206-7-	6.0 MH	MP-848-7-	15 MH	MP-930-7-	15 MH	MP-395-7-	60 MH	MP-254-7-
17.5 MH	MP-206-8-	7.2 MH	MP-848-8-	17.5 MH	MP-930-8-	17.5 MH	MP-395-8-	72 MH	MP-254-8-
20 MH	MP-206-9-	8.6 MH	MP-848-9-	20 MH	MP-930-9-	20 MH	MP-395-9-	86 MH	MP-254-9-
24 MH	MP-206-10-	10 MH	MP-848-10-	24 MH	MP-930-10-	24 MH	MP-395-10-	100 MH	MP-254-10-
30 MH	MP-206-11-	12 MH	MP-848-11-	30 MH	MP-930-11-	30 MH	MP-395-11-	120 MH	MP-254-11-
36 MH	MP-206-12-	15 MH	MP-848-12-	36 MH	MP-930-12-	36 MH	MP-395-12-	150 MH	MP-254-12-
43 MH	MP-206-13-	17.5 MH	MP-848-13-	43 MH	MP-930-13-	43 MH	MP-395-13-	175 MH	MP-254-13-
50 MH	MP-206-14-	20 MH	MP-848-14-	50 MH	MP-930-14-	50 MH	MP-395-14-	200 MH	MP-254-14-
60 MH	MP-206-15-	24 MH	MP-848-15-	60 MH	MP-930-15-	60 MH	MP-395-15-	240 MH	MP-254-15-
72 MH	MP-206-16-	30 MH	MP-848-16-	72 MH	MP-930-16-	72 MH	MP-395-16-	300 MH	MP-254-16-
86 MH	MP-206-17-	36 MH	MP-848-17-	86 MH	MP-930-17-	86 MH	MP-395-17-	360 MH	MP-254-17-
100 MH	MP-206-18-	43 MH	MP-848-18-	100 MH	MP-930-18-	100 MH	MP-395-18-	430 MH	MP-254-18-
120 MH	MP-206-19-	50 MH	MP-848-19-	120 MH	MP-930-19-	120 MH	MP-395-19-	500 MH	MP-254-19-
150 MH	MP-206-20-	60 MH	MP-848-20-	150 MH	MP-930-20-	150 MH	MP-395-20-	600 MH	MP-254-20-
175 MH	MP-206-21-	72 MH	MP-848-21-	175 MH	MP-930-21-	175 MH	MP-395-21-	720 MH	MP-254-21-
200 MH	MP-206-22-	86 MH	MP-848-22-	200 MH	MP-930-22-	200 MH	MP-395-22-	860 MH	MP-254-22-
240 MH	MP-206-23-	100 MH	MP-848-23-	240 MH	MP-930-23-	240 MH	MP-395-23-	1.00 HY	MP-254-23-
300 MH	MP-206-24-	120 MH	MP-848-24-	300 MH	MP-930-24-	300 MH	MP-395-24-	1.20 HY	MP-254-24-
360 MH	MP-206-25-	150 MH	MP-848-25-	360 MH	MP-930-25-	360 MH	MP-395-25-	1.50 HY	MP-254-25-
430 MH	MP-206-26-	175 MH	MP-848-26-	430 MH	MP-930-26-	430 MH	MP-395-26-	1.75 HY	MP-254-26-
500 MH	MP-206-27-	200 MH	MP-848-27-	500 MH	MP-930-27-	500 MH	MP-395-27-	2.00 HY	MP-254-27-
600 MH	MP-206-28-	240 MH	MP-848-28-	600 MH	MP-930-28-	600 MH	MP-930-28-	2.40 HY	MP-254-28-
720 MH	MP-206-29-	300 MH	MP-848-29-	720 MH	MP-930-29-	720 MH	MP-930-29-	3.00 HY	MP-254-29-
860 MH	MP-206-30-	360 MH	MP-848-30-	860 MH	MP-930-30-	860 MH	MP-930-30-	3.60 HY	MP-254-30-
1.00 HY	MP-206-31-	430 MH	MP-848-31-	1.00 HY	MP-930-31-	1.00 HY	MP-930-31-	4.30 HY	MP-254-31-
1.20 HY	MP-206-32-	500 MH	MP-848-32-	1.20 HY	MP-930-32-	1.20 HY	MP-930-32-	5.00 HY	MP-254-32-
1.50 HY	MP-206-33-			1.50 HY	MP-930-33-	1.50 HY	MP-930-33-	6.00 HY	MP-254-33-
1.75 HY	MP-206-34-			1.75 HY	MP-930-34-	1.75 HY	MP-930-34-	7.20 HY	MP-254-34-
2.00 HY	MP-206-35-			2.00 HY	MP-930-35-	2.00 HY	MP-930-35-	8.60 HY	MP-254-35-
2.40 HY	MP-206-36-			2.40 HY	MP-930-36-	2.40 HY	MP-930-36-	10.0 HY	MP-254-36-
3.00 HY	MP-206-37-			3.00 HY	MP-930-37-	3.00 HY	MP-930-37-	12.0 HY	MP-254-37-
				3.60 HY	MP-930-38-	3.60 HY	MP-930-38-	15.0 HY	MP-254-38-
				4.30 HY	MP-930-39-	4.30 HY	MP-930-39-	17.5 HY	MP-254-39-
				5.00 HY	MP-930-40-	5.00 HY	MP-930-40-	20.0 HY	MP-254-40-
				6.00 HY	MP-930-41-	6.00 HY	MP-930-41-	24.0 HY	MP-254-41-
				7.20 HY	MP-930-42-	7.20 HY	MP-930-42-	30.0 HY	MP-254-42-
				8.6 HY	MP-930-43-	8.6 HY	MP-930-43-	36.0 HY	MP-254-43-
				10.0 HY	MP-930-44-	10.0 HY	MP-930-44-		
				12.0 HY	MP-930-45-	12.0 HY	MP-930-45-		
				15.0 HY	MP-930-46-	15.0 HY	MP-930-46-		
				17.5 HY	MP-930-47-	17.5 HY	MP-930-47-		

IN ORDERING: Add suffix "A" to above numbers for clear bushing. Add suffix "B" to above numbers for tapped bushings.

Hermetically sealed toroids in magnetic cases and bare coils are also stocked. Write for catalog.

COMMUNICATION ACCESSORIES COMPANY

HICKMAN MILLS, MISSOURI • PHONE KANSAS CITY, SOUTH 5528

Call
for
our

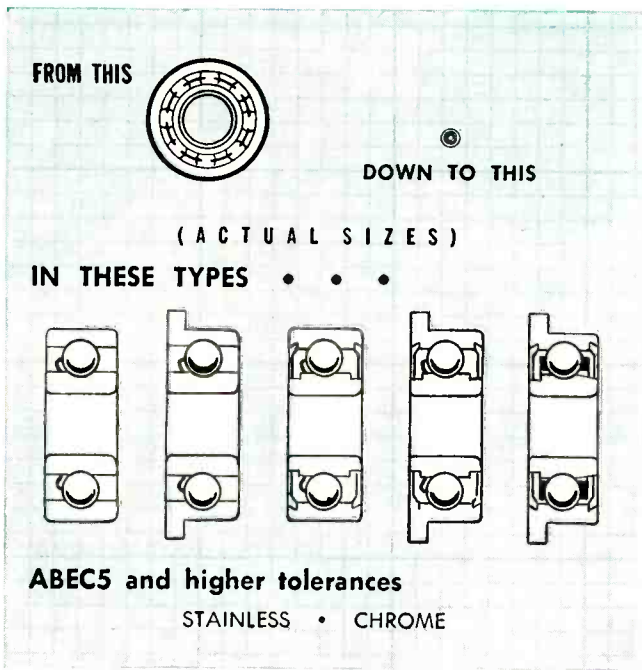

BEARING ENGINEERS

• **PACIFIC COAST**

KERMIT T. SIMONS
Tel. RYan 1-9051

434 North Lake Ave.
PASADENA 4, CALIFORNIA

• **MIDWEST**

JOSEPH W. DANIELS
Tel. Superior 7-0984

49 E. Cedar St.
CHICAGO, ILLINOIS

CHARLES S. WARD
Tel. Trinity 1-4601

646 Hazelwood
DETROIT, MICHIGAN

• **SOUTHWEST**

J. ROBERT NATOLI
Tel. Sterling 2826

P. O. Box 10203
DALLAS, TEXAS

• **EAST**

SIDNEY J. GOODRICH
Tel. HUnter 2-8633

61 Cutter Mill Rd.
GREAT NECK, NEW YORK

CARL F. GRAESSER, JR.

Tel. 424 or 425
PETERBOROUGH, N. H.

**NEW HAMPSHIRE
BALL BEARINGS, INC.**



Peterborough, N. H.
Phone 424 - 425

Call for Catalog 53 — Print 1031 — and Engineering Bulletins

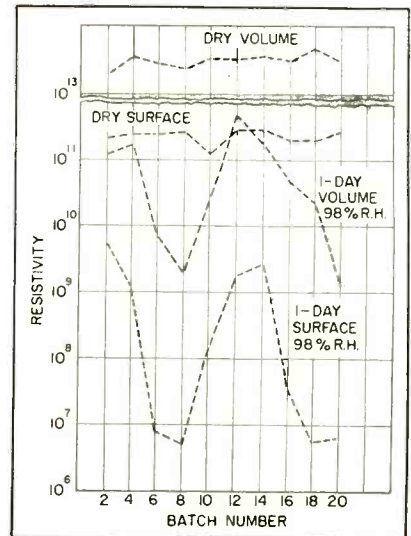

FIG. 2—Volume and surface resistivities of etched wiring boards

low a pH of 0.8, the boards can be cleaned by simple water washing with minimum contamination.

► **Cleaning Procedure**—Though a satisfactory means of preventing sludge contamination had been found, it was recognized that one should be able to salvage contaminated boards by some better cleaning method which would dislodge or dissolve the sludge deposit. Many mechanical cleaning procedures were tried, with unsatisfactory results. Abrasives capable of dislodging this tenacious deposit damaged the phenolic surface. After trying many chemical cleaning techniques it was found that the sludge scum was soluble in a 10-percent solution of oxalic acid. The cleaning procedure consisted of soaking the etched board in a 180F—10-percent oxalic-acid solution with subsequent thorough rinsing in hot water. This process produced etched boards relatively free of contamination.

Tin Reflowing Cuts Wire-Stripping Costs

WIRE preparation costs have been reduced by over 50 percent in the Grand Rapids, Mich. plant of Lear, Inc., by eliminating wire retwisting and retinning operations after cutting and stripping stranded wire. This is accomplished by a tin reflow method that uses an induc-

A GIANT FOR ITS SIZE !

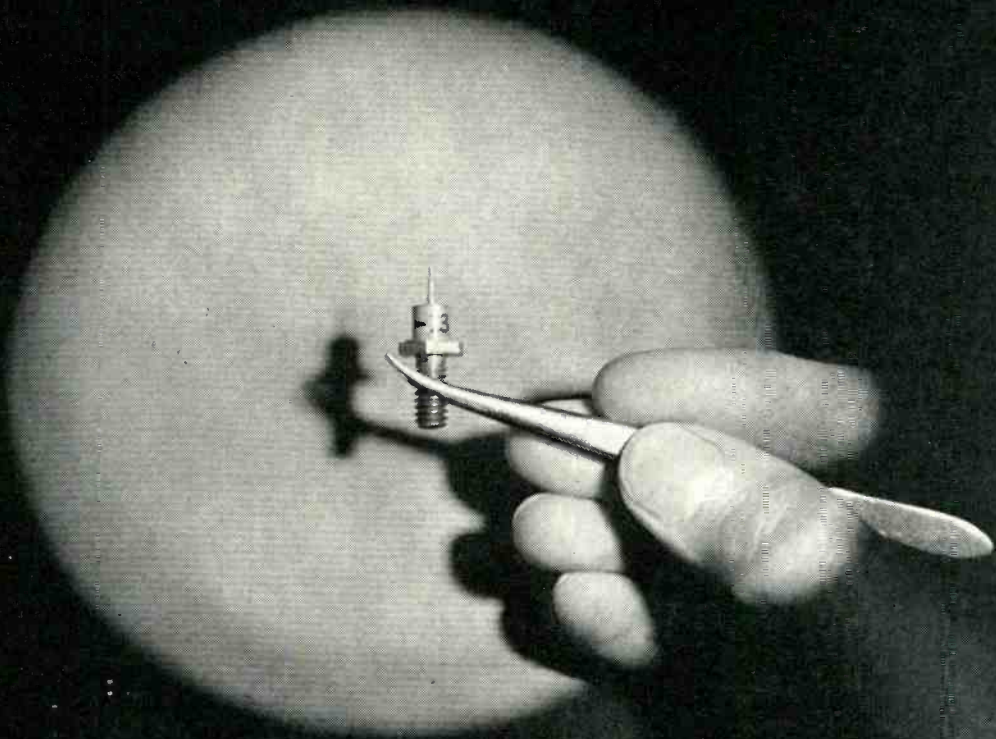

Telephone science produces an important new rectifier

At Bell Laboratories one line of research is often fruitful in many fields. Latest example is the silicon power rectifier shown above.

Product of original work with semiconductors—which earlier created the transistor and the Bell Solar Battery—the new rectifier greatly reduces the size of equipment needed to produce large direct currents. It is much smaller than a tube rectifier of equal performance and it does not require

the bulky cooling equipment of other metallic rectifiers.

In the Bell System the new rectifier will supply direct current more economically for telephone calls. It can also be adapted to important uses in television, computers, industrial machines, and military equipment. Thus, Bell Telephone Laboratories research continues to improve telephony—while it helps other fields vital to the nation.



Above, new rectifier (held in pliers) is contrasted with comparable tube rectifier and its filament transformer, rear. Mounted on a cooling plate, lower center, the new rectifier can easily supply 10 amperes of direct current at 100 volts, that is 1000 watts—enough to power 350 telephones.

BELL TELEPHONE LABORATORIES



IMPROVING TELEPHONE SERVICE FOR AMERICA PROVIDES
CAREERS FOR CREATIVE MEN IN SCIENTIFIC AND TECHNICAL FIELDS

UNIQUE SENSITIVE RELAY
incredibly small,
lightweight and
adjustable!

ADVANCE "SO" SERIES

Here for the first time is a sensitive relay only 1-7/32" x 1-1/8" x 1-1/4"... weighing only 1-1/2 ounces, and adjustable over a wide range. You get much more latitude with this relay in designing for tiny areas.

The Advance "SO" is set at the factory to operate on 10 milliwatts. User can adjust it down to 2 milliwatts, or any desired pick-up or drop-out, by means of fine screw contacts. A balanced armature provides extremely sensitive operation. The unit is highly efficient, ruggedly built, and offers excellent shock and vibration-resistant characteristics.

Contact arrangement is SPDT. Coil resistances: 4000, 6500 and 10,000 ohms. Life expectancy: 250,000 operations. Available in open types... dust-tight or hermetically sealed enclosures. Now in quantity production. Advance "SO" relays are priced amazingly low. Write for literature.

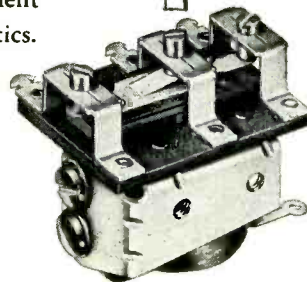

tion heating generator and special measuring devices developed by Reeve Electronics, Inc., 609 W. Lake St., Chicago.

This equipment, which is placed between the roll of wire and any wire stripper, automatically senses the points along the wire where cutting and stripping will occur. It applies a short pulse of r-f heating energy to these points as the wire travels into the wire-stripping machine to melt the tin

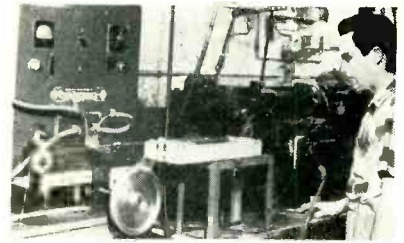

Installation of Reevelec induction heating generator mounted ahead of wire-stripping machine. After fusing of tinned strands by work coil, wire passes through pan of cooling water

on the individual strands. This effectively solders them into a solid bundle that will not fray under the strain of cutting and stripping. The wires can then be fitted into tight terminal lugs or other small orifices without retwisting.

A precision electronic timer, triggered by the wire stripper, controls the heat cycle with great accuracy, so that no overheating discoloration of wire or deformation of even low-temperature plastic jackets occurs. The equipment is being used successfully with various MIL spec wires, Teflon-jacketed wire and with Teflon-jacketed silver-plated wire.

Recorder Checks Linearity of Precision Pots

PAPER tracings showing actual performance of precision linear potentiometers are produced automatically by a motor-driven linearity checker in Fairchild's Hicksville, N. Y. plant. The potentiometer is inserted in a fixture on the motor-driven turntable and tightened to hold the housing stationary. The beginning of the winding is then

Coil Resistance	Pick Up Voltage	Pick Up Current	Drop Out Voltage	Drop Out Current	Max. Coil Voltage for Continuous Duty	Overtravel	Contact Gap
4000	6.4 V	1.6 MA	3.2 V	.8 MA	110 V	.0015	.002/.003
6500	8.1 V	1.25 MA	3.9 V	.6 MA	140 V	.0015	.002/.003
10,000	10 V	1 MA	5 V	.5 MA	175 V	.0015	.002/.003

ADVANCE ELECTRIC AND RELAY CO.

2435 N. NAOMI STREET, BURBANK, CALIF.
 AN ELGIN NATIONAL WATCH COMPANY AFFILIATE



Attention Broadcast Men!

35 History-Making Articles on "Scatter Propagation"

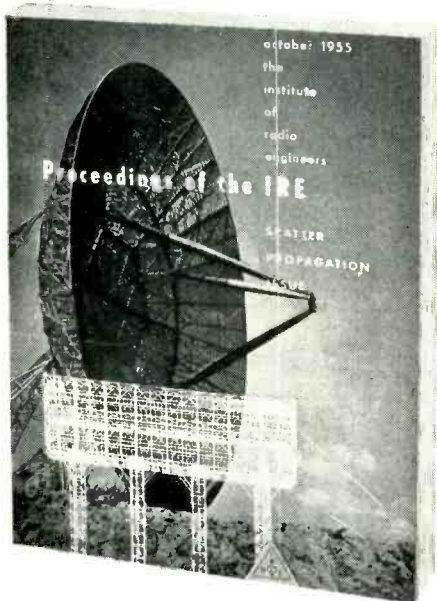

Whenever radio seemingly reaches its limit, such as the "line of sight" range of TV, then radio engineers find a way to smash that limit ... and open up whole new fields.

Now it's "Scatter Propagation"... the way to unlimited "line of sight" broadcasting ... discovered and perfected by radio engineers.

And now, for the first time, it is fully reported in 35 great articles in the October issue of "Proceedings of the IRE."

All IRE members will devour this issue and treasure it as they have the history-making issues on Color TV, Transistors, Electric Computers, etc. This October number will rank high as a practical service to the whole industry—a great reference text of 380 pages—and someday become a collector's item among radio engineers.

Price to non-members... \$3.00



The Institute of Radio Engineers

1 East 79th Street • New York 22, N. Y.

1. "Foreword", by K. A. Norton and J. B. Wiesner
2. "Characteristics of Beyond-the-Horizon Radio Transmission", by K. A. Bullington
3. "Radio Transmission at VHF by Scattering in the Lower Ionosphere", by D. K. Bailey, R. Bateman and R. C. Kirby
4. "On the Scattering of Radio Waves by Turbulent Fluctuations of the Atmosphere", by F. Villars and V. F. Weisskopf
5. "Aerodynamic Mechanisms Producing Electronic Density Fluctuations in Turbulent Ionized Layers", by R. M. Gallet
6. "Some Remarks on Scattering from Eddies", by R. A. Silverman
7. "Investigations of Ionospheric Forward-Scatter Propagation at Frequencies Exceeding MUF", by W. G. Abel, J. T. deBettencourt, J. F. Roche and J. H. Chisholm
8. "UHF Long-Range Communication Systems", by G. L. Mellen, W. E. Morrow, A. J. Pote, W. H. Radford and J. B. Weisner
9. "Diversity Reception in UHF Long-Range Communications", by C. L. Mack
10. "Factors Affecting Spacing of Radio Terminals in a UHF Link", by I. H. Gerks
11. "Demonstration of Bandwidth Capabilities of Beyond Horizon Tropospheric Radio Propagation", by W. H. Tidd
12. "Characteristics of Tropospheric Scattered Fields", by L. G. Trolese
13. "Results of Radio Propagation Tests on Beyond-Horizon Paths", by K. Bullington, A. L. Durkee and W. J. Inkster
14. "Investigations of Angular Scattering and Multipath Properties of Tropospheric Propagation of Short Radio Waves Beyond the Horizon", by J. H. Chisholm, P. A. Portmann, J. T. deBettencourt and J. F. Roche
15. "Some Tropospheric Scatter Propagation Measurements Near the Radio Horizon", by H. Janes and P. I. Wells
16. "Rate of Fading in Tropospheric Propagation", by K. A. Norton, H. B. Janes and A. P. Barsis
17. "Probability Distribution of the Amplitude of a Constant Vector plus a Raleigh Distributed Vector", by K. A. Norton, L. E. Vogler, W. V. Mansfield and T. J. Short
18. "Trans-Horizon Microwave Propagation over Hilly Terrain", by H. Kurihara
19. "VHF Tropospheric Overwater Measurements Far Beyond the Radio Horizon", by L. A. Ames, P. Newman and T. F. Rogers
20. "Foreward Scattering of Radio Waves by Anisotropic Turbulence", by H. Staras
21. "Note on Scatter Propagation with a Modified Exponential Correlation Function", by A. D. Wheelon
22. "Propagation of Short Radio Waves in a Normally Stratified Troposphere", by T. J. Carroll and R. M. Ring
23. "Measurements of the Phase of Radio Waves Received Over Transmission Paths with Electrical Lengths Varying as a Result of Atmospheric Turbulence", by J. W. Herbstreit and M. C. Thompson
24. "Phase Difference Variations in 9350 Megacycle Radio Signals Arriving at Spaced Antennas", by A. P. Deam and B. M. Fannin
25. "Survey of Airborne Microwave Refractometer Measurements", by C. M. Crain
26. "Amplitude, Scale and Spectrum of the Refractive Index Inhomogeneities in the First 125 Meters of the Atmosphere", by G. Birnbaum and H. E. Bussey
27. "Some Applications of the Monthly Median Refractivity Gradient in Tropospheric Propagation", by B. R. Bean and F. M. Meaney
28. "Some Fading Characteristics of Regular VHF Ionospheric Propagation", by G. R. Sugar
29. "Line-of-Sight Propagation Phenomena, I. Ray Treatment", by R. B. Muchmore and A. D. Wheelon
30. "Line-of-Sight Propagation Phenomena, II. Scattered Components", by A. D. Wheelon and R. B. Muchmore
31. "Near-Field Corrections to Line-of-Sight Propagation", by A. D. Wheelon
32. "Obstacle Gain Measurements over Pikes Peak at 60 to 1046 Mc", by R. S. Kirby, H. T. Dougherty and P. L. McQuate
33. "The Role of Meteors in Extended-Range VHF Propagation", by O. G. Villard, Jr., E. R. Echleman, L. A. Manning and A. M. Peterson
34. "Certain Mode Solutions of Forward Scattering by Meteor Trails", by G. H. Keitel
35. "The Use of Angular Distance in Estimating the Median Transmission Loss and Fading Range for Propagation through a Turbulent Atmosphere over Irregular Terrain", by K. A. Norton, P. L. Rice and L. E. Rogers

Proceedings of the IRE

1 East 79th Street, New York 22, N. Y.

Enclosed is \$3.00

Enclosed is company purchase order for the October, 1955 issue on "Scatter Propagation."

Send to:

Name _____

Company _____

Address _____

City & State _____

PRECISION Continental Connectors

printed circuit connectors available for 1/16", 3/32" and 1/8" board

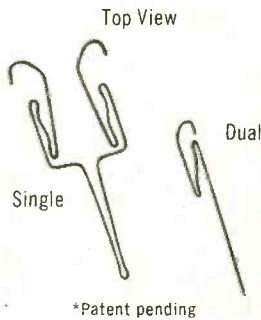

*Patent pending

NEW... "BELLOWS TYPE" CONTACTS*

Provides longer contact life and smoother engagement. Wider printed circuit cord thickness tolerances are now possible with Continental Connectors utilizing "bellows type" contacts. ON A STANDARD 1/16" COPPER CLAD LAMINATED PRINTED CIRCUIT CARD THE "BELLOWS TYPE" CONTACT ALLOWS FOR AS MUCH AS .054" TO .071" VARIATION IN BOARD THICKNESS.

SOLDER LUG CONTACTS

Single or double row contact construction (6, 10, 15, 18, 22 or 28 contacts). Up to 56 connections are possible with two rows of 28 contacts each. Polarizing stud can be placed at any contact point on the connector. Rating: 10 amps. Contacts take #16 AWG wire.

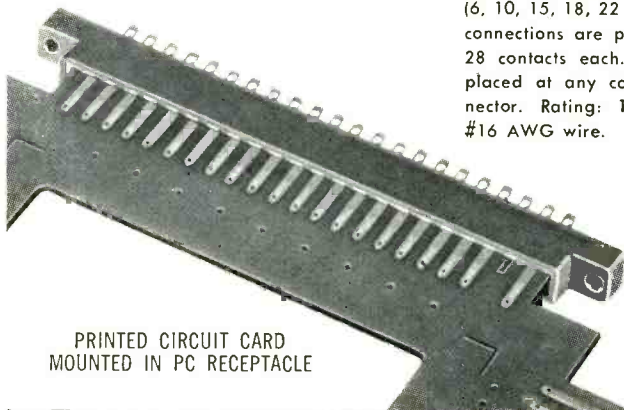

PRINTED CIRCUIT CARD MOUNTED IN PC RECEPTACLE



Linearity checker in operation

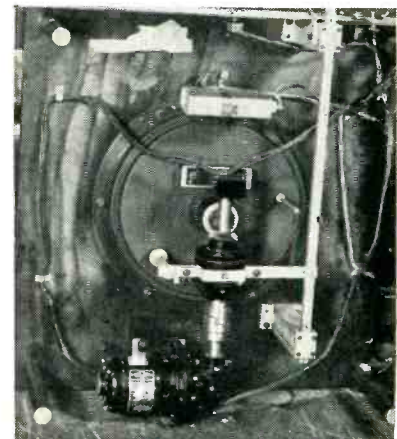

Bottom view of motor-driven turntable on which potentiometer is mounted

zeroed with the aid of a scope and a split collet is tightened over the potentiometer shaft.

The potentiometer connections made for this initial setup also serve for connecting to the checking cir-

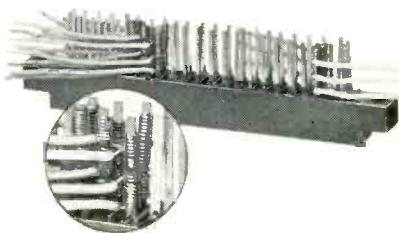

SOLDERLESS WIRE WRAP CONTACTS

No soldering required. (Name and number of tool for "wire wrap" available on request.) 44 contacts (two rows of 22) accommodate three #24 AWG wires each. Receptacle accommodates .093 board.

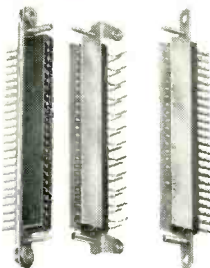

TAPER PIN CONTACTS

Accommodates "AMP 53" taper pins. No soldering necessary. Stainless steel brackets support printed circuit assembly. Illustrated (center) is a dip solder-type plug which can be mounted at 90° to printed circuit card - a Continental Connector special design which mates with receptacle at left.

Technical data on these connectors, and special designs requiring the use of sub-miniature, hermetic seal, pressurized, high voltage or power connectors, are available on request. Write today for complete catalog.

Electronic Sales Division
 DeJUR-Amsco Corporation,
 45-01 Northern Boulevard, Long Island City 1, N. Y.

DeJUR

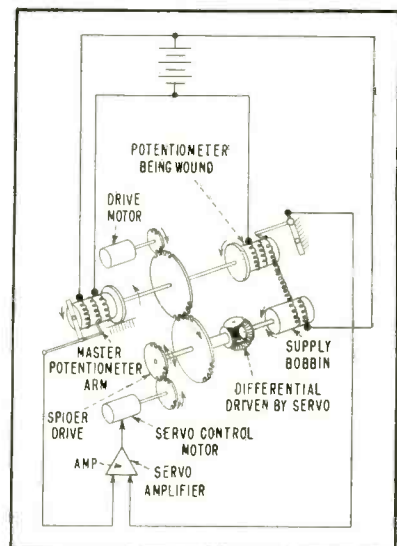

Circuit of linearity checker

**NEW HUDSON
STANDARD
CASES**

**Available
From Stock!**

**STANDARD
RECTANGULAR
SIZES**

HU-688:
DIMEN. A— $\frac{5}{8}$ "
DIMEN. B— $1\frac{5}{16}$ "
LENGTH— $\frac{3}{8}$ "

HU-734:
DIMEN. A— $1\frac{11}{16}$ "
DIMEN. B— $1\frac{9}{32}$ "
LENGTH— $1\frac{27}{64}$ "

HU-736:
DIMEN. A— $\frac{3}{4}$ "
DIMEN. B— $1\frac{15}{16}$ "
LENGTH— $\frac{7}{8}$ "

HU-745:
DIMEN. A— $\frac{3}{4}$ "
DIMEN. B— $1\frac{15}{16}$ "
LENGTH— $1\frac{3}{8}$ "

HU-750:
DIMEN. A— $\frac{7}{8}$ "
DIMEN. B— $1\frac{1}{16}$ "
LENGTH— $1\frac{3}{8}$ "

HU-796:
DIMEN. A— $\frac{5}{8}$ "
DIMEN. B— $1\frac{5}{16}$ "
LENGTH— $2\frac{1}{2}$ "

HU-826:
DIMEN. A— $1\frac{11}{16}$ "
DIMEN. B— $1\frac{9}{32}$ "
LENGTH— $1\frac{5}{8}$ "

HU-844:
DIMEN. A— $1\frac{11}{16}$ "
DIMEN. B— $1\frac{9}{32}$ "
LENGTH— $1\frac{1}{4}$ "

**STANDARD
ROUND SIZES**

HU-727:
OUTSIDE DIA.— $1\frac{1}{4}$ "
LENGTH— $\frac{1}{2}$ "

HU-728:
OUTSIDE DIA.— $1\frac{1}{16}$ "
LENGTH— $2\frac{1}{4}$ "

HU-737:
OUTSIDE DIA.— $1\frac{15}{64}$ "
LENGTH— $1\frac{13}{32}$ "

HU-760:
OUTSIDE DIA.— $2\frac{1}{32}$ "
LENGTH— $5\frac{1}{16}$ "

HU-771:
OUTSIDE DIA.—.742"
LENGTH— $\frac{3}{4}$ "

HU-773:
OUTSIDE DIA.— $1\frac{1}{16}$ "
LENGTH—1"

HU-806:
OUTSIDE DIA.— $1\frac{9}{64}$ "
LENGTH— $1\frac{7}{8}$ "

HU-819:
OUTSIDE DIA.— $4\frac{9}{64}$ "
LENGTH— $2\frac{1}{64}$ "

**STANDARD
SQUARE SIZES**

HU-709:
DIMEN. A—1"
LENGTH— $2\frac{1}{8}$ "

HU-789:
DIMEN. A—1"
LENGTH— $1\frac{1}{2}$ "

HU-793:
DIMEN. A—1"
LENGTH— $1\frac{19}{32}$ "

HU-808:
DIMEN. A— $1\frac{1}{64}$ "
LENGTH— $1\frac{25}{32}$ "

HU-810:
DIMEN. A— $4\frac{5}{64}$ "
LENGTH— $7\frac{1}{16}$ "

HU-847:
DIMEN. A—1"
LENGTH— $2\frac{1}{4}$ "

**File This Page for
Future Reference**

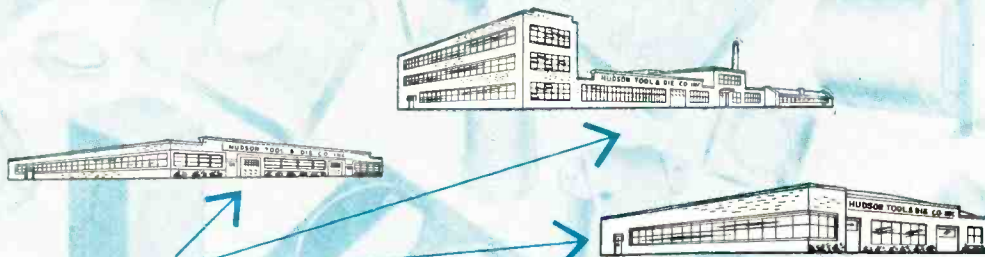

3* FULLY-EQUIPPED PLANTS

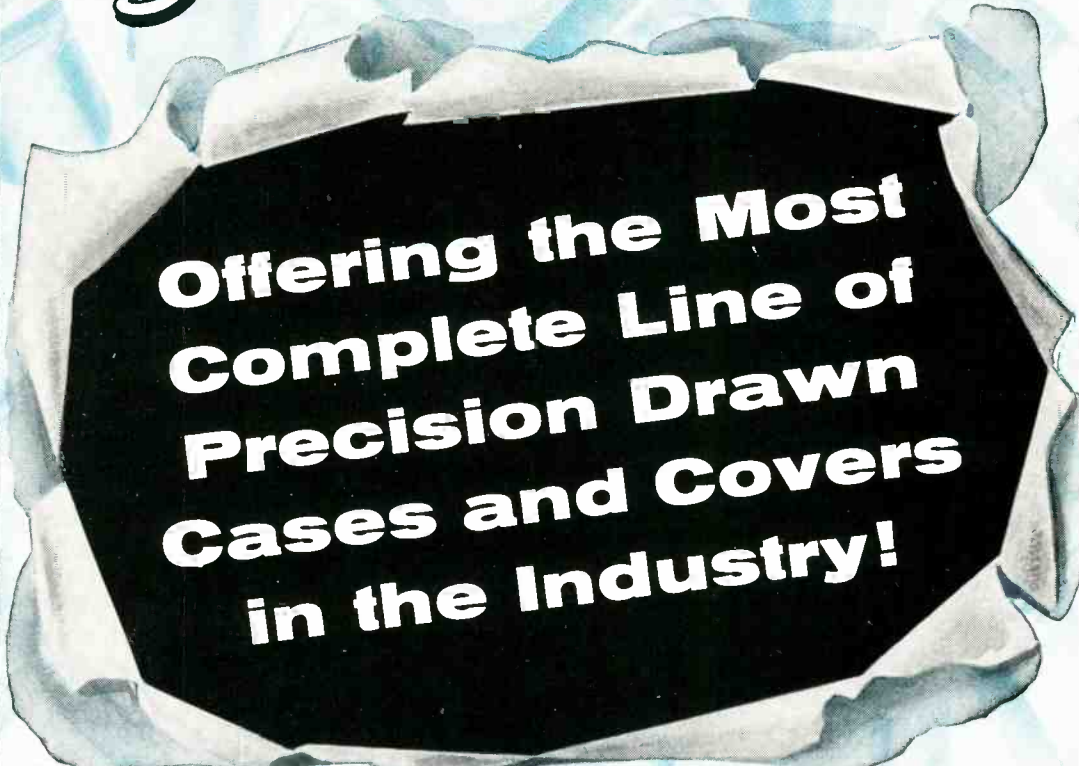

**Offering the Most
Complete Line of
Precision Drawn
Cases and Covers
in the Industry!**

...THREE COMPLETE SERVICES!*

Hudson Standard Metal Closures

Over 1000 economical standard types mean HUDSON can supply precision components at commercial prices. A wide variety of optional features make it possible to solve all but the most unusual closure requirements with standard types selected from HUDSON stocks.

Hudson Quality Metal Stampings

Metal parts produced to your exact specifications at prices that reflect the economies of mass production methods. Hudson can work to close tolerances and maintain uniformity throughout production runs. Quotations supplied promptly on receipt of drawings.

Hudson Sheet Metal Facilities

Depend on HUDSON for expert fabrication of simple or complex sub-assemblies. Facilities include certified welding of alloys, silver soldering, brazing and chrome plating.

**NEW
CATALOG
READY,
NOW!**



The Hudson story is contained in one handy catalog. Full descriptions of all standard items and complete information on Hudson metal working facilities. Call or write for your copy, now!

Precision Components of
Steel, Aluminum, Copper,
Brass, Mu Metal



**HUDSON
TOOL & DIE COMPANY • INC**
118-122 SOUTH 14th ST., NEWARK 7, N. J.

POLYPENCO® **NON-METALLIC** SHAPES

For low-cost fabrication specify POLYPENCO Shapes... modern forms for industrial non-metallics

- MACHINE ON STANDARD METALWORKING TOOLS
- HAVE COMPLETE CONTROL OVER PRODUCTION
- ELIMINATE MOLD COSTS
- DEPEND ON UNIFORM HIGH QUALITY
- IMMEDIATE DELIVERY—NO PRODUCTION LAG

NYLON

POLYPENCO 101 Nylon—the standard for quality and performance—tough, abrasion resistant, durable.

Rod • Tubular Bar
Strip • Slab
Tubing

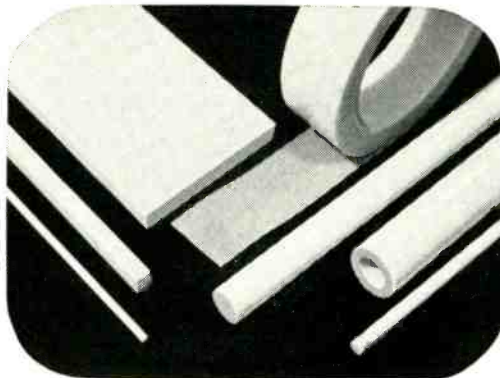

TEFLON

Provides excellent resistance to heat and moisture, with outstanding electrical and chemical properties.

Rod • Tape
Tubing • Slab
Spaghetti Tubing

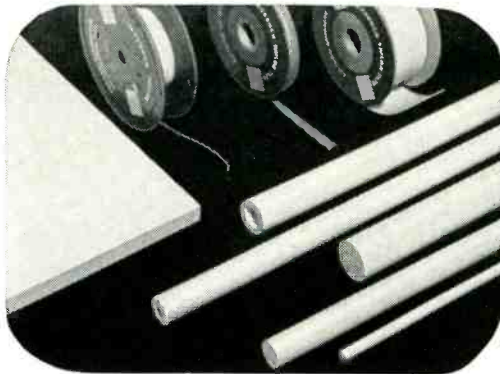

Q-200.5

Rigid, clear, transparent material widely used for r.f. and uhf. insulators.

Rod... and other shapes on special order.

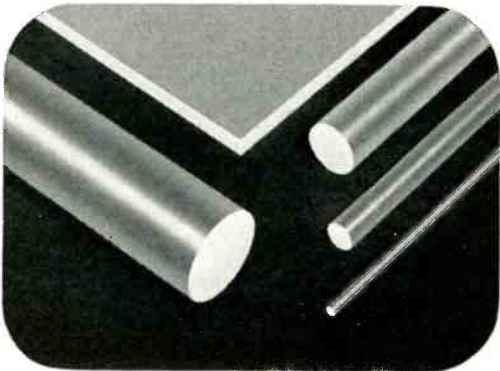

Order from your nearest warehouse...
Write for Bulletins and Price Lists

THE POLYMER CORPORATION of Penna. • Reading, Penna.
In Canada: Polypenco, Inc., 2052 St. Catherine W., Montreal, P. Q.



POLYPENCO® nylon, teflon* and other non-metallics

*DU PONT TRADEMARK

Warehouse stocks: Boston • Buffalo • Chicago • Cleveland
Dayton • Detroit • Los Angeles • Minneapolis • Montreal
New Haven • Reading • St. Louis • Toronto

cuit that includes a 10-inch-diameter 150,000-ohm master potentiometer. This provides different loading arrangements to permit checking zero-base, terminal or independent linearity as required. A Brush Magnetic Penmotor with special amplifiers serves as the recorder.

After a pattern has been run off, an appropriate template is placed over it to check at a glance whether the unit is within the established tolerance limits. The trace also reveals shorted turns at taps.

Automatic Belting for Machine-Fed Components

AUTOMATIC belting machines that place fixed resistors and capacitors on narrow belts of pressure-sensitive tape have been developed and constructed by Allen-Bradley Co., Milwaukee, Wis. to meet the growing demand for reel packaging by users of automatic assembly machines.

The machines each weigh about 350 lb and are about 4 feet high, 3½ feet long and 26 inches wide. A 1/20-hp electric motor inside each unit runs a simple chain-drive mechanism that operates the indexer (a sprocket type wheel that uniformly feeds the individual re-

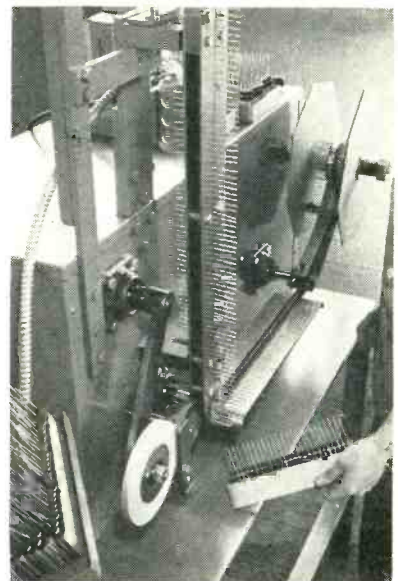

Machine in operation. Operator loads vertical slide from prefilled corrugated paper sleeves holding resistors or capacitors

Picture Quality Is Our Business Too!

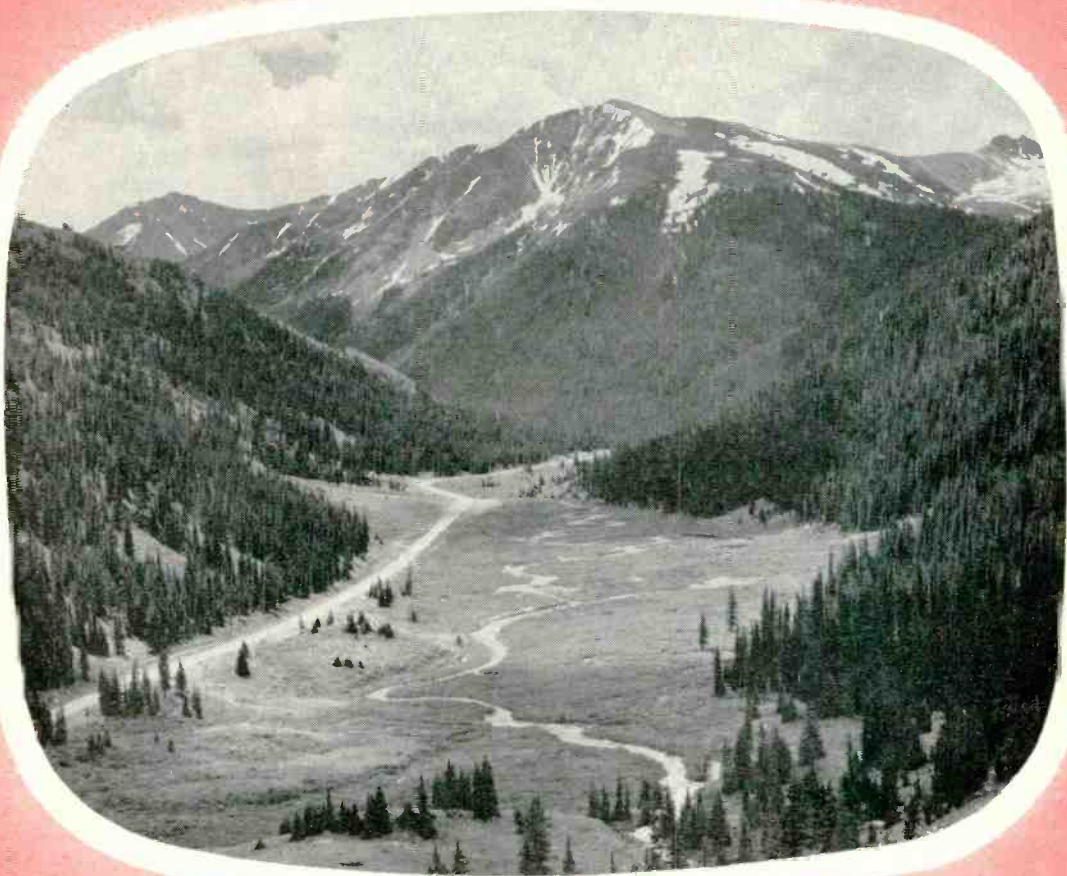

Set designers assure their customers steady, clear pictures by careful component selection. Good-All backs that selection with reliable capacitors at economical cost. The enthusiastic acceptance of **GOOD-ALL MARBELITE** and **SERAMELITE** tubulars is a measure of the confidence designers have in these capacitors. Tens of millions are in use today in TV and Radio Sets of leading manufacturers.

Good-ALL
capacitors

MARBELITE

Marbelite capacitors are best known for their physical and electrical ruggedness. Good-All type 503-M provides solid plastic construction at surprisingly low cost. A miniature series is also available for applications in which space is limited.

SERAMELITE

The seramelite family of capacitors is housed in ceramic tubes with end-seals of a tough, dense plastic. Their performance under conditions of high temperature and humidity is outstanding. Various impregnants are available and Seramelite types with "MYLAR" dielectric are becoming increasingly popular.

Get full information by writing GOOD-ALL direct or contacting our nearest sales representative.

GOOD-ALL ELECTRIC MFG. CO. • GOODALL BLDG. • OGALLALA, NEBRASKA

New, Free Catalog Helps You Solve Your Crystal Problems

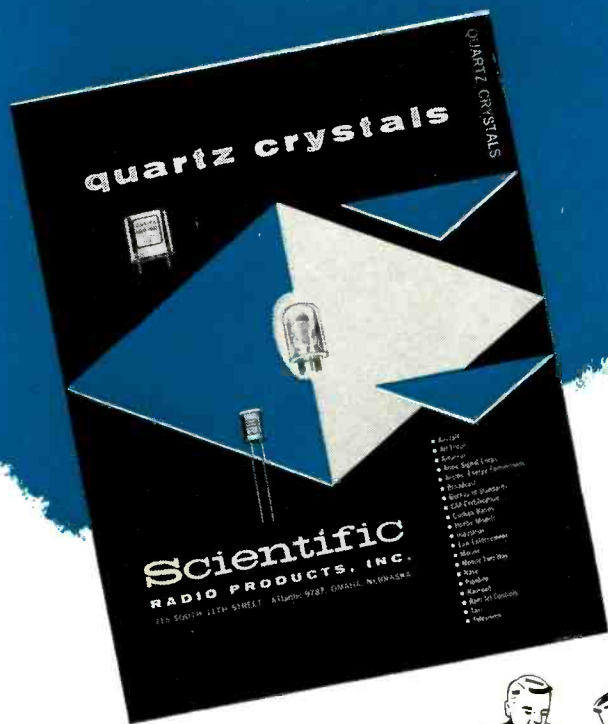

Your work will go faster and easier with Scientific's new catalog

It includes complete information on:

- All military and commercial crystals now in common use
- New developments in crystal miniaturization and glass enclosed crystals
- Scientific's free counseling service, research facilities, and prototype engineering service
- Scientific's custom production unit that manufactures crystals to your exact specifications
- Sales engineers strategically located throughout the entire United States

Be Specific — Say Scientific —

- complete line of crystals
- highest quality
- highly competitive prices
- prompt delivery

SCIENTIFIC RADIO PRODUCTS, INC.

215 South 11th St. • ATLantic 9787 • OMAHA, NEBR.

One of the Oldest Manufacturers of Crystals in the United States

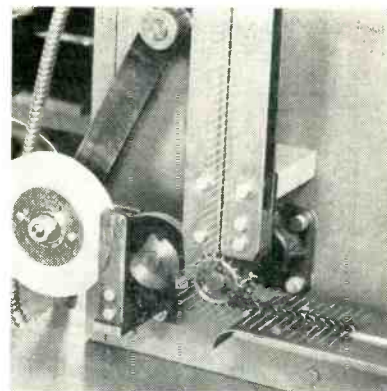
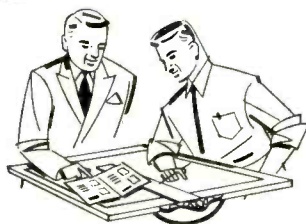

After 12-inch leader has been run out, resistors are gravity-fed onto the tape, which is pulled from bottom of white roll at left and runs over top of black rubber buffing roller

sistors or capacitors to the tape) and the rewind reel.

Each machine—manned by a single woman operator—has a production capacity of between 10 and 20 filled reels (better than 20,000 individual units) per hour. To maintain this production the operator's only duties are to replenish the supply of tape, reels and units being belted, and to control the flow of tape-beltting with a stop-start foot pedal.

► **Getting Started**—Readying a machine for use takes the operator only about a minute and calls for the following steps:

(1) Mounting a 60-yard roll of the Minnesota Mining and Manufacturing Co.'s Scotch brand No. 898 filament tape (either $\frac{1}{4}$ or $\frac{3}{8}$ inch wide depending on the size of the resistors or capacitors to be belted.)

(2) Threading the tape—adhesive side up—between a rubber pressure roller and the indexer and

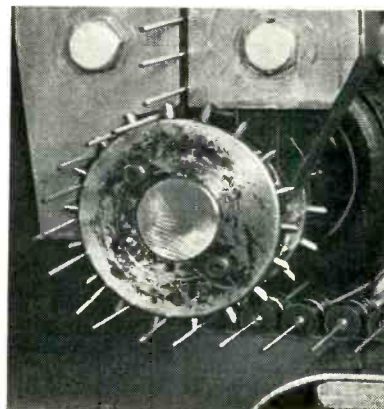

Closeup of indexer that controls spacing of units on tape belt

MAIL
COUPON
TODAY
FOR
FREE
CATALOG

SCIENTIFIC RADIO PRODUCTS, INC.
215 South 11th St., Omaha, Nebr.

Please send me your new, free catalog.
I understand there is no obligation.

NAME _____

BUSINESS ADDRESS _____

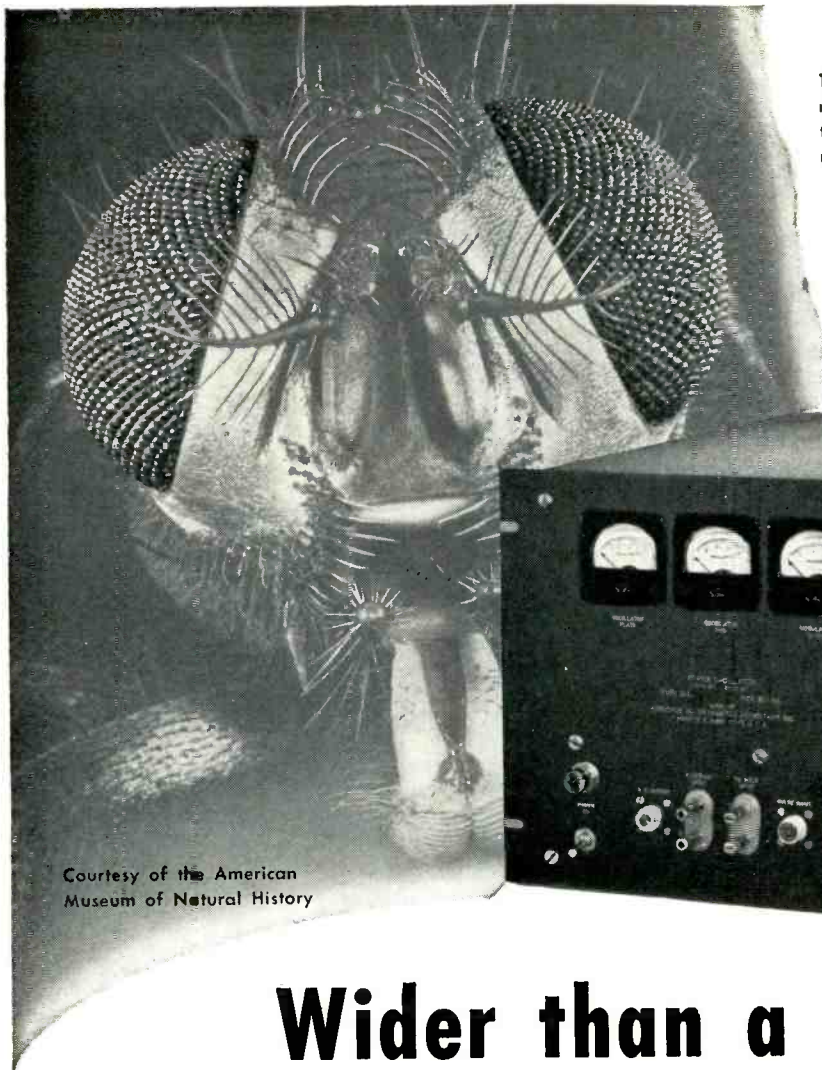

Courtesy of the American
Museum of Natural History

The unique construction of the fly's eye, with numerous tiny lenses on a convex surface, gives the insect an extensive visionary area, in all directions.



Wider than a fly can see

Unlike most of nature's children, man's endeavors have carried him far beyond the use of his natural endowments. Spurred on by mental development, human efforts have created a dynamic way of life, demanding the most versatile mechanisms man is able to devise.

Scientists at Airborne Instruments Laboratory are constantly at work, creating electronic devices to aid industrial progress. In the Wide Range Power Oscillator, they have achieved an instrument, excellent in performance and quality, for testing over the wide frequency range of 300 to 2500 mc.

Equipped with a self-contained rectifier power supply and a single tuning control for grid-cathode and grid-plate lines, the Wide Range Power Oscillator is representative of Airborne's high standard of achievement in research, development and production. Here is another example of individual design, resulting in the universal appeal of ALL products.

Write for descriptive literature.



160 OLD COUNTRY ROAD • MINEOLA, NEW YORK

your "special" transformers are stock units at *Chicago Standard*

Most CHICAGO-STANCOR transformers are available in at least three different mountings and terminal types . . . some in as many as six! You can get the one that is best for your job . . . and get it fast, from stock, through your CHICAGO-STANCOR distributor.

CHICAGO-STANCOR transformers are the logical choice for

- Industrial and military research and instrumentation
- Prototype production
- Amateur and commercial broadcasting
- Communications
- High fidelity
- Public address



<p>H Type</p>	<p>C and TD Types</p>
<p>B Type</p>	<p>S Type</p>
<p>V and C Types</p>	<p>M Type</p>
<p>A, J, L. and U Types</p>	<p>FS Type</p>

FREE: CHICAGO STANDARD catalogs listing over 1000 transformers for original equipment and replacement applications.



CHICAGO STANDARD TRANSFORMER CORPORATION

ADDISON AND ELSTON | Export Sales: Roburn Agencies, Inc.
CHICAGO 18, ILLINOIS | 431 Greenwich Street, New York 13, N. Y.

pulling out about a foot of tape to act as a leader.

(3) Loading the vertical feeder slide with 1/2-watt, 1-watt or 2-watt units from prefilled corrugated paper sleeves holding from 25 to 50 units each.

(4) Starting the machine, which in turn automatically begins applying the units to the tape and feeding the leader end of the tape out until it can be attached to the rewind reel.



Attaching tape leader to core of reel

(5) Attaching the tape-leader to the reel's core completes the operation.

► **Reel Specifications**—During production the number of reels that can be completed with one 60-yard roll of tape depends entirely on the size of the units being belted. For example, it takes about 52 feet of tape (allowing one foot on each end as a leader) to complete one 2,500-capacity reel of 1/2-watt units and about 42 feet to fill a 1,000-capacity reel with 2-watt units. In the former case about 3 1/2 reels can be done with one roll of tape, while in the latter instance about 4 1/2 reels is tops. The 12-inch leaders that precede the first unit and trail off from the last unit on the belt are designed to facilitate loading into customer machines and for splicing the new belt to the belt of an emptying reel.

The expendable 9- and 12-inch

New Resistor Stands Higher Overloads... Without Crazing!



The "Blue Ribbon", resistor with a higher wattage rating per unit space requirement. Made by Hardwick, Hindle, Inc., Newark, N. J.

because of DRIVER-HARRIS 146 ALLOY



Here is a resistor really new and different . . . the compact Hardwick, Hindle "Blue Ribbon," which stands remarkably high overloads and excessive heat without crazing.

Special design features which make this possible are: an aluminum thru-bar extending through the center of the elliptical ceramic core, which insures a more even distribution of heat to prevent "hot-spots;" and a thermo-shock-proof enamel coating which eliminates crazing.

Heretofore, crazing, which occurred mostly at terminal areas, shortened resistor life and limited the safety factor. To prevent this, an alloy with three hard-to-find qualities was needed: (1) It had to have a coefficient of expansion to match all integral parts; (2) it had to be free of gas; (3) it had to form a perfect bond with the enamel.

A large order, indeed. But Driver-Harris filled it

by developing #146, a glass-to-metal sealing Alloy. This alloy now makes it possible to operate resistors and rheostats at hitherto dangerous overloads, with no risk of breakdowns in the enamel coatings.

146 Alloy is one of 4 Driver-Harris Alloys which cover most glass-to-metal sealing needs—available as rod, wire, strip, sheet foil, and in special shapes. Today the makers of the "Blue Ribbon" use 146 Alloy for the terminals in all of their resistors and rheostats as well. They also use Nichrome*, Advance*, and other gas-free resistance alloys made by Driver-Harris in winding the cores.

What you can learn from this is clear. If you also need a special purpose alloy, send us your specifications. Our engineers with 48 years of experience are at your service.

One of a new line of "H" Series high wattage rheostats made by Hardwick, Hindle, using Driver-Harris Alloys.

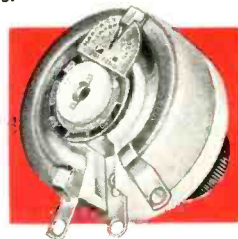

*T. M. Reg. U. S. Pat. Off.

Nichrome and Nichrome V are made only by



Driver-Harris Company HARRISON, NEW JERSEY

BRANCHES: Chicago, Detroit, Cleveland, Louisville, Los Angeles, San Francisco

In Canada: The B. GREENING WIRE COMPANY, Ltd., Hamilton, Ontario

MAKERS OF THE MOST COMPLETE LINE OF ELECTRIC HEATING, RESISTANCE, AND ELECTRONIC ALLOYS IN THE WORLD

ELECTRO TEC

Corporation
Manufacturers

Slip Ring Assemblies

of

HYSOL 6000 EPOXIDE RESINS

•

PRODUCTION TECHNIQUES

(continued)



Securing filled reel by pressing down 12-inch trailing leader

reels now being used by Allen-Bradley have a 1-inch diameter core upon which the tape-belt is started and octagon-shaped side shields of fiberboard construction. Their width varies from $3\frac{1}{4}$ inches for belted $\frac{1}{2}$ -watt units to $4\frac{1}{2}$ inches for 2-watt units.

To ready the filled reels for shipment, the packaging department merely tapes a cardboard retainer ring around the circumference of the belted units and packs the reels in individual cartons. Six such cartons are then placed in a master carton for shipment.

Water-Dip Solution Keeps Terminals Clean

CLEAN metal is kept clean for later soldering, welding or finishing operations by immersion in Water Dip No. 33, made by Maas and Waldstein Co., Newark, N. J. The resulting coating does not interfere with any electrical contacts, wiring or parts that must be attached to the chassis. The soldering operation is actually improved and speeded up by this treatment, as it keeps the plated surface chemically clean.

The coating is best applied by dipping the plated or chemically cleaned parts directly from the last hot water rinse, while the parts are still wet. This insures maintenance of a chemically clean surface free from water spots and runs. The protective coating prevents fingerprinting or staining of plated parts during assembly, storage and use.

In one test, 5,000 radio chassis units were copperplated and water-



The Electro Tec Corp. selected HYSOL 6000 Series tubes to make slip ring assemblies. That's because the outstanding electrical, thermal and mechanical properties of HYSOL 6000 epoxide compounds provided an ideal material for precise machining, intricate silverplating and ease of handling. The ability to withstand wear contributed heavily to its use in a mechanism for the transfer of electrical current from a stationary to a rotating mechanism.

Houghton Laboratories, Inc., supplies HYSOL 6000 Series tubes in certain sizes to Electro Tec Corp. and also furnishes the basic resin compound for formulating tubes in varying sizes. The 6000 Series includes a complete line of easily machined sheets, tubes and rods, room temperature and heat curing potting and casting compounds and coating and laminating varinshes.

Again, HYSOL 6000 Series epoxide compounds show a remarkable adaptability for a variety of applications. Perhaps one of your design or production problems can be solved with the use of this new plastic. Remember, complete research, design and production facilities at Houghton Laboratories, Inc., are ready to help you in any such problem. Inquiries are invited at no obligation. Learn for yourself what HYSOL 6000 Series compounds might be able to do for you. Phone, wire or write today!



houghton laboratories, inc.

OLEAN, NEW YORK

CLIFTON PRECISION'S

NEW 8

SIZE

SYNCHROS

ACTUAL SIZE



Available in all Types!



ACCURACY 7 MINUTES · WEIGHT 32 GMS.

Function	Type Number	Primary Element	Excitation Voltage 400 cy.	Input Current (ma.)	Input Power (Watts)	Primary Impedance Secondary Open (Phase)	Primary Resistance (line)	Secondary Element	Output Voltage	Secondary Impedance Primary Open (Phase)	Secondary Impedance Primary Shorted	Secondary Resistance (line)	Phase Shift Degrees	Sensitivity mv./deg.	Accuracy Minutes Max.
Transmitter	CGC-8-A-7	Rotor 1 Phase	26	100	.50	54+ j260	37.0	Stator 3 Phase	11.8	12+ j45	15+ j3.5	11.8	8	200	7
Control Transformer	CTC-8-A-1	Stator 3 Phase	11.8	90	.230	28+ j110	24.7	Rotor 1 Phase	23.6	220+ j740	246+ j60	143	8.5	400	7
Control Transformer	CTC-8-A-4	Stator 3 Phase	11.8	37	.091	67+ j270	59.5	Rotor 1 Phase	24	508+ j1680	640+ j190	381	9.2	400	7
Resolver	CSC-8-A-1	Stator 2 Phase	11.8	84	.268	38+ j136	27.0	Rotor 2 Phase	23.2	280+ j600	344+ j75	230	11	400	7
		Rotor 2 Phase	26	39	.430	280+ j600	230.	Stator 2 Phase	10.6	38+ j136	70+ j29	27.0	20	180	7
Repeater	CRC-8-A-1	Rotor 1 Phase	26	100	.50	54+ j260	37.0	Stator 3 Phase	11.8	12+ j45	15+ j3.5	11.8	8	200	30*
Differential	CDC-8-A-1	Stator 3 Phase	11.8	85	.21	27+ j120	25.0	Rotor 3 Phase	11.8	38+ j122	47+ j14	36	9	200	7 Rotor 7 Stator

Total Null max. 20mv for each unit

Also available in 115v 400 cy. primary, 90v secondary Transmitters, C.T.'s, Receivers

*Torque 2600 mg.-mm./degree from CGC-8-A-7

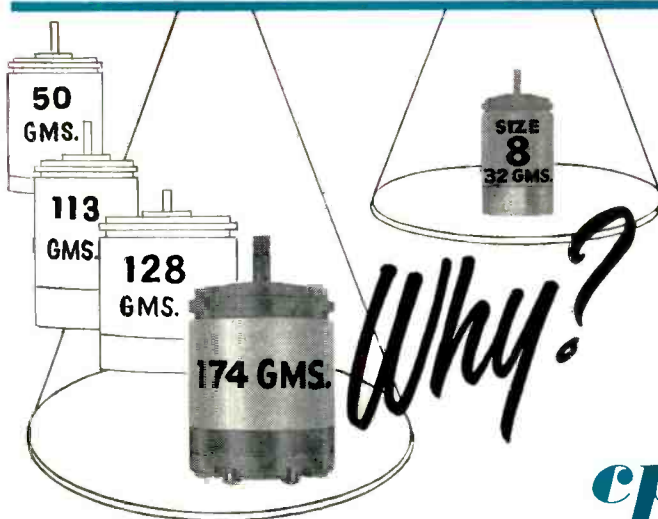

WHY USE 1945 SYNCHROS IN 1956 DESIGNS?

Clifton's new Size 8's can take the place of larger units at very significant saving in bulk and weight.

These new Size 8's are now in use in some of the latest and *lightest* avionic equipment. In equipment which must be flown, why load on extra weight?

Samples are available from stock, quantities from the production line.

LOOK TO CPPC FOR SYNCHRO PROGRESS

cppe

CLIFTON PRECISION PRODUCTS COMPANY INC.

CLIFTON HEIGHTS

PENNSYLVANIA



GATES 20 kw,
2 to 22 mc,
Short Wave
Broadcast
Transmitter
for Indonesia

FOUR REASONS WHY GATES RADIO USES JENNINGS VACUUM CAPACITORS

1. TOP PERFORMANCE IN ALL CLIMATES

They are impervious to dust and moisture and are self-healing after moderate overloads.



Two UH 10-75 mmfd
Neutralizing Capacitors.

2. TROUBLE-FREE OPERATION

They require no maintenance and are designed to last the life of the transmitter.

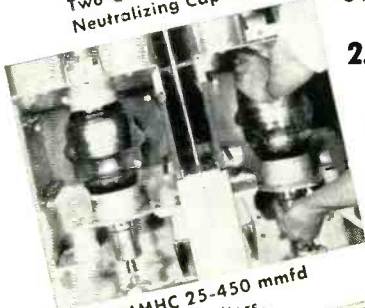

Two VMMHC 25-450 mmfd
Main Tank Capacitors.

3. WIDE CAPACITY RANGE

They make possible a continuously variable frequency range of 2 to 22 mc without complicated switching circuits.

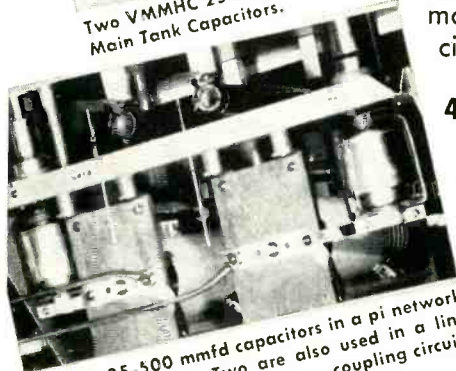

Four UCS 25-500 mmfd capacitors in a pi network
in the driver stage. Two are also used in a line
coupling circuit.

4. SMALL PHYSICAL SIZE

Their vacuum dielectric has inherent advantages of high voltage and current ratings in a small physical space.

Send for our catalogue summary of vacuum capacitors and switches.

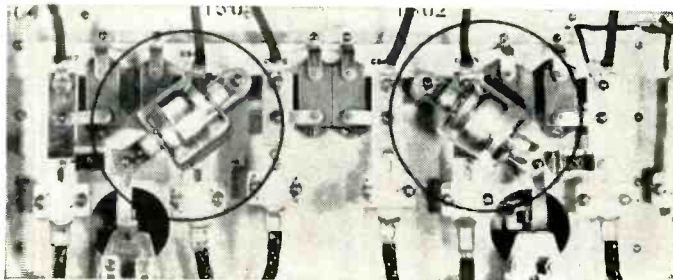

Two JCS 250 mmfd coupling capacitors.

**JENNINGS RADIO MFG. CORP. 970 McLAUGHLIN AVE.
POST OFFICE BOX 1278 • SAN JOSE 8, CALIFORNIA**

dipped. The results were: no rejects; sets looked good when shipped; good electrical contacts obtained at all riveted and soldered joints.

Television parts were nickelplated and water-dipped resulting in good electrical contact even though high currents were used between parts in mechanical contact. Television transmitter panels and racks looked good in spite of handling received during assembly. Little retouching of the finish was needed.

In another test, terminals on coils and terminal boards were plated and dipped, with a dye added for identification. This permitted easy soldering, speeded-up assembly work and reduced checking and testing time. A glance showed the inspector and operator if the correct wire was on the correct terminal. Various dye solutions are available for this use.

Electronic pianos have springs which are identical except for wire diameter. Here again, use of dyes in the dip gives easy identification along with protection.

Filament-Inserting Funnel

A SIMPLE mount assembly jig with a tiny built-in funnel is used to position parts precisely while inserting multi-leg folded filaments into the cathode sleeves of miniature tubes in the Bloomfield, N. J. tube plant of Tung-Sol Electric Inc.

The jig is rigidly mounted on the workbench, to leave both hands of the operator free for assembly. With her left hand she picks up tube mount and places it in the lower part of the jig. With her

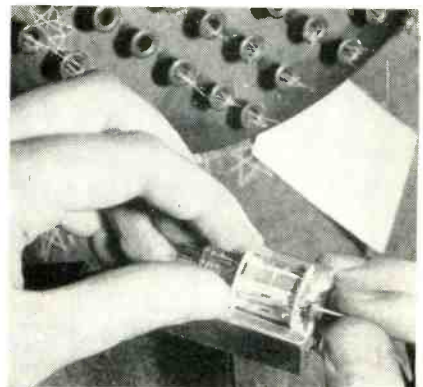

First step in inserting filament

**RATED AT:
8 AMPERES**

115 volts — 60 cycles
non-inductive load
Contact Combinations up to
3 POLE • DOUBLE THROW

The **GUARDIAN**[®]
Multi-Purpose

SERIES 1200 RELAY

... a Mighty Midget!

- Midget Size
- Versatile
- Flexible
- Rugged

APPLICATIONS:

- Automation
- Computers
- Communications
- Circuitry Projects
- Remote Control Units
- Automatic Selectors
- Electronic Controls
- Switching Devices

CHARACTERISTICS:

COIL

Standard voltages. 6 to 230 volts, 60 cycles, A.C., non-inductive; 6 to 110 volts, D.C.
Terminals. Solder lug type.

CONTACTS

Rating. Available for 1½ amperes or 8 amperes, 115 volts, 60 cycles, non-inductive load.

Combination. Available in any standard combination up to 3 P.D.T.

Material. Fine silver is standard; other materials to specification.

MOUNTING

Standard. Single hole 6-32 tapped. Bottom mounting.

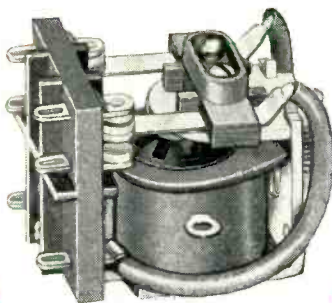

ACTUAL SIZE

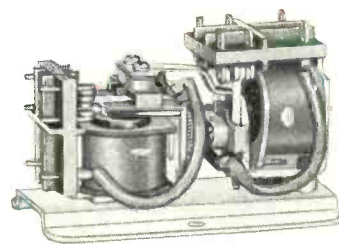

GUARDIAN

Series 1200/1200 Interlock

Standard Series 1200 is also available as an Interlocking Relay, in any A.C./A.C., D.C./D.C. or A.C./D.C. combination.

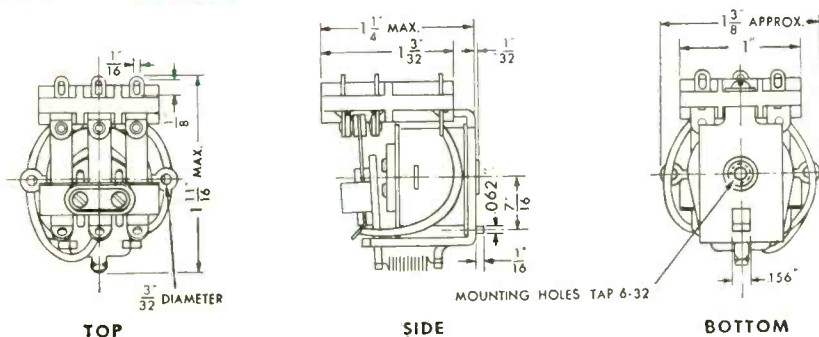

• **Ultra-small . . . but packed with power!** This compact, efficient relay is **RATED AT 8 AMPERES**, 115 volts, 60 cycles non-inductive load! Contact combinations up to 3 pole, double throw. Never before has so much power capacity been combined with so many possible contact combinations within such midget proportions. Unit measures approximately 1 5/8" long, 1" wide, by 1 1/4" high. Weighs only 1.9 ounces.

Solder Terminals molded in phenolic block, with barriers for over-surface insulation meet Underwriters' Laboratories specifications. It is extremely rugged. Series 1200 has already achieved extraordinary success in the applications listed to the left. It promises to become the most popular of all midget relays in every industry, yours included.

write today to arrange for a production sample.
Include blue print or circuit diagram if possible.

Telephone CHESAPEAKE 3-1100

GUARDIAN  **ELECTRIC**
1625-MW. WALNUT STREET CHICAGO 12, ILLINOIS
A COMPLETE LINE OF RELAYS SERVING AMERICAN INDUSTRY

Only Precision OFFERS YOU HIGHEST QUALITY, LOW COST PAPER TUBING



in
any shape
every size
any length
plus
any ID
every OD
any quantity

**DIELECTRIC KRAFT • FISH PAPER • CELLULOSE ACETATE
COMBINATIONS • PHENOL IMPREGNATED**

Round, square, rectangular, triangular, any shape, any size — Precision Paper Tube Co. can provide *all* your paper tubing needs. Your specifications are met to the most exacting tolerances. Precision Paper Tubes are sturdy, crush resistant, have high tensile strength and excellent dimensional stability.

Send in your specifications for samples. Request Arbor List of over 2000 sizes.



HIGH DIELECTRIC BOBBINS FOR BETTER COILS

Precision-made on specially designed equipment, using the finest materials, to provide maximum tensile strength, light weight, more winding space and other essential electrical and mechanical characteristics.

Furnished in any size or shape. Supplied plain or fitted with leads, slots or holes. Flanges cut to specification, plain or embossed. Tube ends swaged to lock flanges.

Send Specifications for samples. Ask for illustrated folder.

Sales Representatives in:

New England: Framingham, Massachusetts, Trinity 3-7091

Metropolitan New York, New Jersey:

Jersey City, New Jersey, Journal Square 4-3574

Upstate New York: Syracuse, New York, Syracuse 4-2141

Northern Ohio, Western Penn.: Cleveland, Ohio, Atlantic 1-1060

Indiana, Southern Ohio: Logansport, Indiana, Logansport 2555

California: Pasadena, California, Sycamore 8-3919

Canada: Montreal, Quebec, Canada, Walnut 0337



PRECISION PAPER TUBE CO.

2041 W. CHARLESTON ST.

CHICAGO 47, ILL.

Plant No. 2: 79 Chapel St., Hartford, Conn.

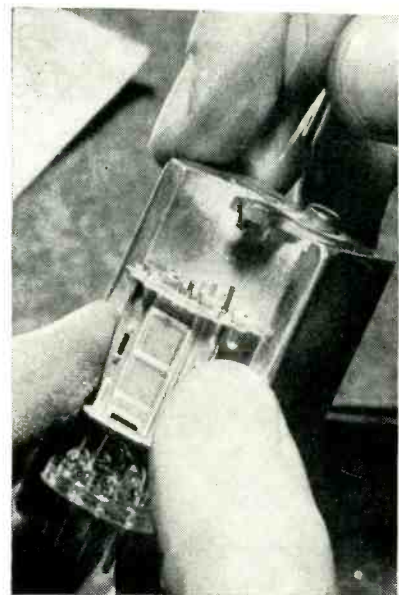

Pushing filament through funnel into cathode of tube mount

right hand she removes a folded filament from the carrying tray and inserts it in the funnel-shaped hole at the top of the jig. The final operation involves bringing the tube mount up to the funnel, which places the cathode sleeve directly under the funnel so that the filament can be pushed in easily and without damage.

Vacuum Metallizing of Selenium Rectifiers

By J. GORDON SEITER

Manager, High-Vacuum Division
F. J. Stokes Machine Company
Philadelphia, Pennsylvania

IN THE manufacture of selenium rectifiers in the Buffalo plant of Westinghouse Electric Corp., vacuum metallizing provides accurate control over the thickness of metal deposited and produces the desired crystal structure to give the required performance characteristics.

Aluminum sheets approximately 25 inches square are nickel-plated conventionally, then placed inside a stainless-steel drum and held in place against the inner surface by small spring-steel clips. This drum is then rolled into the vacuum chamber of the large metallizer made by F. J. Stokes Machine Co. of Philadelphia. The chamber is evacuated to a low pressure and selenium is evaporated onto the plates from a heat source where the temperature is precisely con-

For accuracy in flight...



*...you need accuracy
in manufacturing*

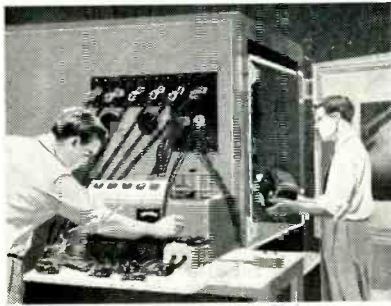

With 400-cycle equipment, you just can't take chances... the very lives of both plane and crew depend on its accurate operation. And to get accurate *output*, you need accurate *input*... during engineering and manufacturing as well as in flight. That's why makers of aircraft systems and components everywhere depend on Leach for the *precise* power needed during design and testing of 400-cycle equipment.

Now, Leach offers a new 400-cycle power supply for laboratory or in-plant use... a complete package ready to "plug-in." Characteristics equal those of Leach's widely used mobile ground-power packages—the units trusted for supplying precise power during vital pre-flight checkout— and ratings from 3 to 125 KVA are available.

**Send today for the latest brochure on
Leach's broad line of 400-cycle power supplies.**

PRECISE 400 CYCLE POWER

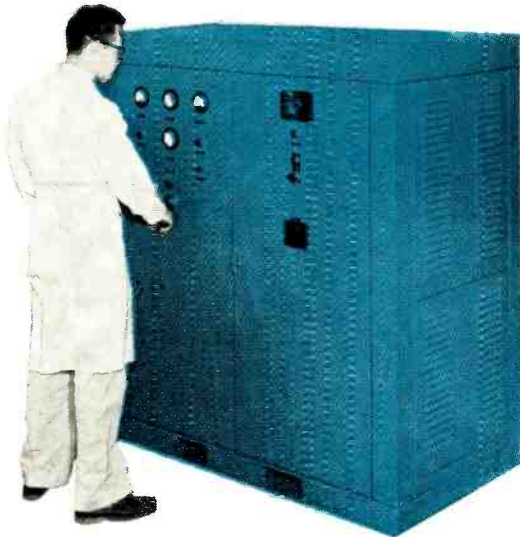

RATING	3 phase—5 to 125 KVA at .8 P.F. 1 phase—3 to 85 KVA at .8 P.F.
OVERLOAD RATING	150% for 5 minutes; 200% for 5 seconds
REGULATION:	
Frequency	400 cps \pm 0 cps with 60 \pm 0 cps input
Voltage	\pm 1%
RECOVERY TIME	100 milliseconds
VOLTAGE MODULATION	less than .25%
FREQUENCY MODULATION	less than .25%
PHASE BALANCE	per MIL-E-7894A
WAVE FORM	3% rms total harmonic content (2% rms available on special order)

LEACH

LEACH RELAY DIVISION

INET-PALMER DIVISION

CORPORATION | INET-PALMER DIVISION

4441 S. SANTA FE AVE., LOS ANGELES 58, CALIFORNIA

SERVING INDUSTRY IN THE LABORATORY—IN THE PLANT—ON THE GROUND—IN THE AIR

DISTRICT OFFICES AND REPRESENTATIVES IN PRINCIPAL CITIES OF U. S. AND CANADA

Standardized Electronic Hardware:

IMMEDIATE DELIVERIES

World's Largest Stock

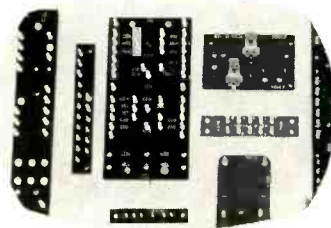
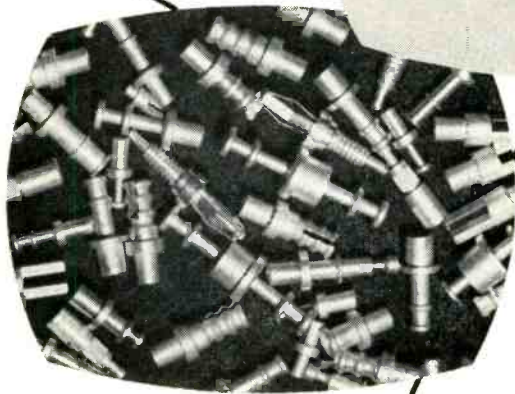

You get immediate delivery from the largest warehouse stock of silver plated terminal lugs in the world. This means you put your line into production without delay. Over 21 million pieces ready for immediate shipment.

NO JAMMING—No jammed swaging machines nor delays due to off-sized units. USECO'S precision manufacture and quality control guarantees smooth performance. Lugs are specially processed after machining to eliminate distortion.

"USECO-PLATE" — "USECO-PLATE," exclusive silver plating, insures consistent thickness over the entire surface. Meets Federal Specs. Special lacquer dip prevents corrosion, helps solder-bond. Various platings such as gold, cadmium, hot tin dipped, etc., are available on request.

TERMINAL BOARDS—Prompt stock delivery of Standard

Boards. Specials to your specifications. All operations under one roof to speed delivery and maintain undivided responsibility.

PRINTED CIRCUITS—"WRAP-AROUND," "PLATED-THRU" and "FLUSH" circuits. Noted for correct plating, extreme accuracy, excellent pattern definition, better contact, easier unplugging—all adding up to guarantee unsurpassed performance.

CATALOGS—See our condensed catalog pages in The MASTER and in ELECTRONIC BUYER'S GUIDE. For more information, write for complete catalog. Please address Dept. 16

U. S. ENGINEERING CO., INC.

A Division of Litton Industries, Inc.

521 COMMERCIAL ST., GLENDALE 3, CALIF.

trolled to produce the proper type of crystal structure. The drum is rotated within the chamber while the selenium is being evaporated so that as the vapor rises, it will coat the surface of all the sheets. The drum with the plates attached is then rolled into another evaporator for deposition of the barrier film over the selenium.

After the barrier film has been deposited, the sheets are removed from the drum and broken into



Type of metallizing unit used for depositing selenium. Drum rolls out on pipe rails for loading

small plates along scored lines, to give squares ranging up to 5 in., depending on the rectifier capacity desired. A mask is placed over the coated side of the sheets, protecting a narrow strip around the edges of the plate and a narrow band around a central hole in the plate. The unmasked portion is then sprayed with cadmium or zinc to provide a contact layer on the plate.

After this contact layer has been sprayed on, the plates go into a Stokes vacuum shelf-dryer where they are again heated, under vacuum conditions, to refine still further the crystal structure of the selenium and the barrier layers. The plates are then ready for assembling into complete rectifiers.

Resistor Lead Cutter

SIDE LEADS of flat wire-wound resistors are cut to length on an ordinary paper cutter in Emerson's Jersey City plant. Though started as an emergency procedure for small lots of resistors, the simple tech-

AMP Taper Tab
receptacles for wire
sizes 26 to 18

AMP Taper Pins
for wire sizes
26 to 16



AN CONNECTOR

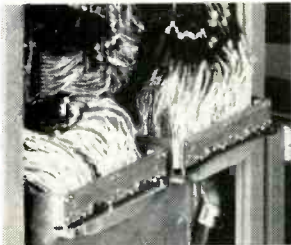

CONNECTOR BLOCK—2000 CONNECTIONS

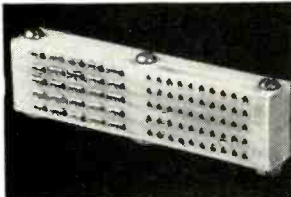

A-MP TAPER BLOK

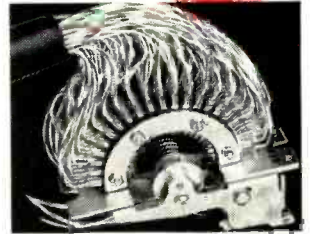
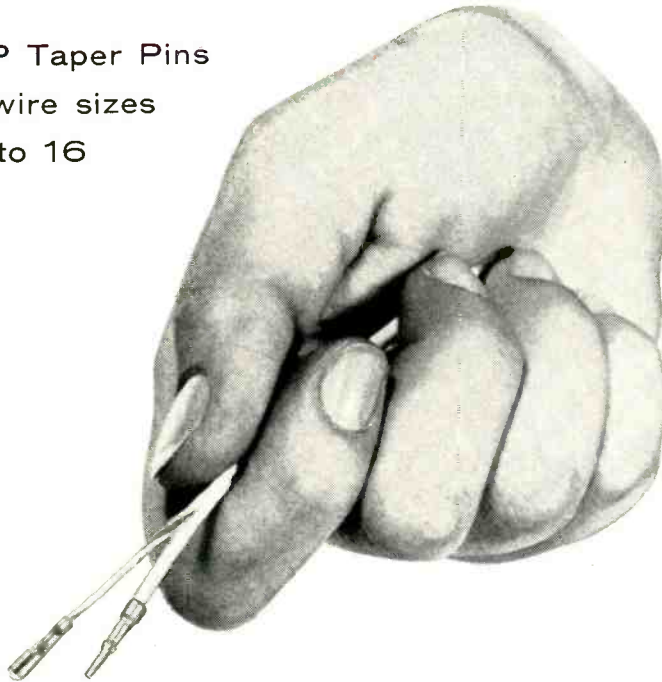

STEPPING SWITCH

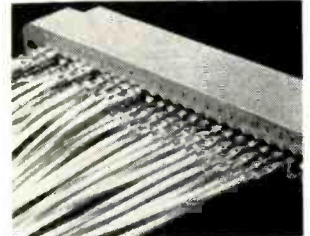

PRINTED CIRCUIT CONNECTOR

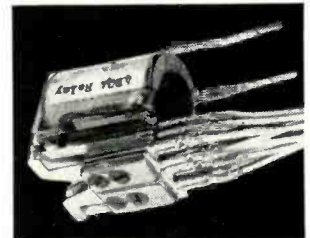

TAPER TAB RELAYS

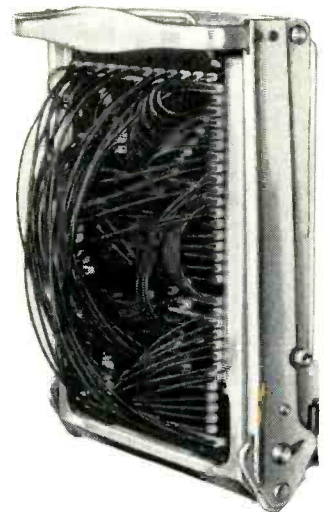

Patchcord Programming System
— for programming analogue and
digital computers, data process-
ing equipment, test equipment,
automatic control equipment and
similar devices. ©AMP®

Less Cube — Less Cost GREATER RELIABILITY

Cubic restrictions have brought about a whole new concept of wire termination. The AMP Taper Technique with AMP taper pins, tab receptacles, blocks and modified miniature components will help you take full advantage of small wire, small insulation and small space for your wire terminations.

AMP Trade-Mark Reg. U. S. Pat. Off. © AMP



AIRCRAFT-MARINE PRODUCTS, INC., 2100 Paxton Street, Harrisburg, Pa.
In Canada: AIRCRAFT-MARINE PRODUCTS OF CANADA, LTD., 1764 Avenue Road, Toronto 12, Ontario, Canada

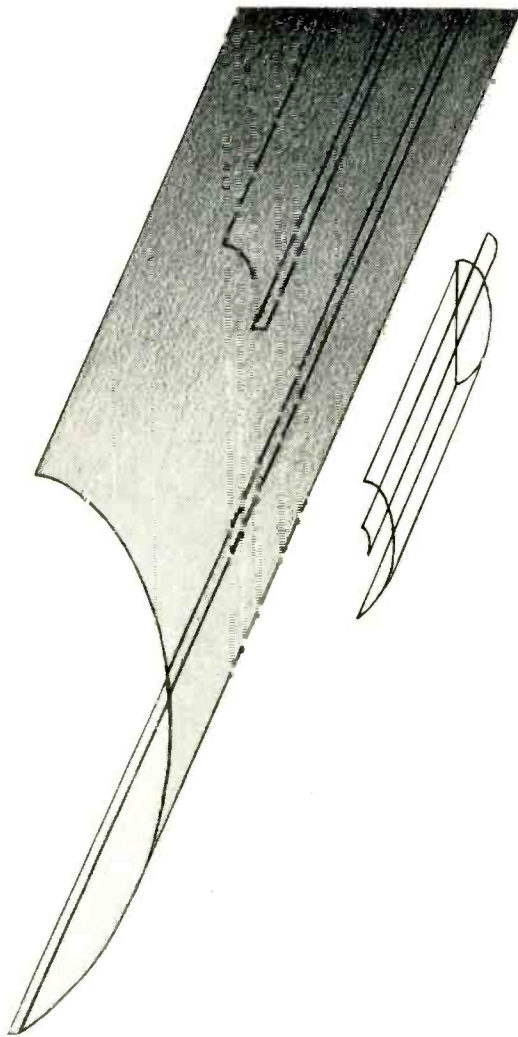

Problem shape impact extrusions?

A source . . . with sure deliveries and a 30 year old reputation . . .

SunTube
CORPORATION

HILLSIDE, NEW JERSEY

IMPACT EXTRUSIONS • CONDENSER CANS AND SHELLS

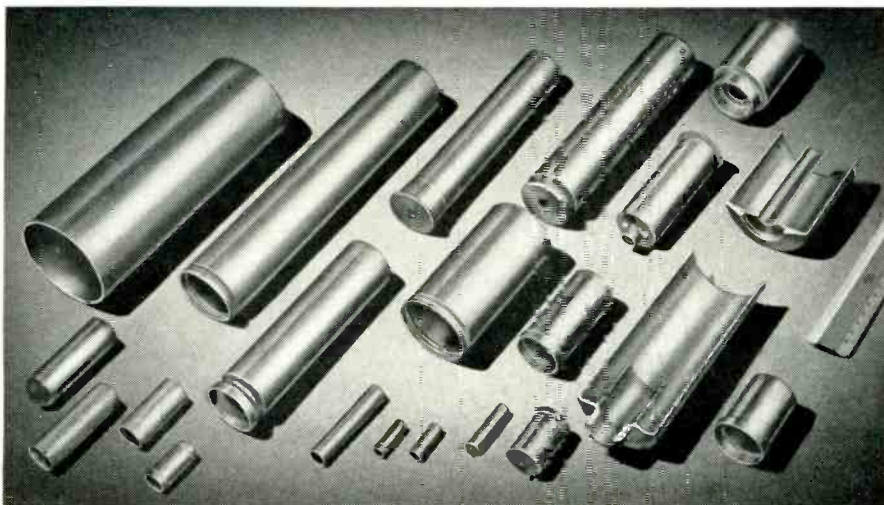

ALUMINUM • ZINC • LEAD • TIN • SILVER

nique proved surprisingly effective. The regular paper stop on the 15-inch-square board of the cutter is set to serve as a guide against which the resistors are held to give the desired lead length. The operator can easily hold two resistors against this at a time with her left hand while bringing down the cutter with her right hand.

Rotational Life-Tester

By L. KLEIST

*The Magnavox Co.
Fort Wayne, Indiana*

BASIC requirement for a rotational life-testing machine is a cyclic rotational motion variable both in magnitude of arc and speed of cycling. In the simple machine shown, this is achieved by converting the rotational motion of the motor to cyclic rotation through the reciprocating action of a rack

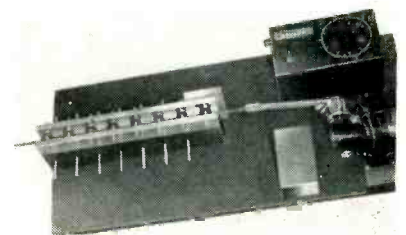

Rack-and-gear drive for fourteen components, with drive motor at lower right and Variac speed control at upper right

and gear train. The degrees of rotation are controlled by varying the distance of travel of the rack by a variable eccentric arm connected to the motor shaft.

Limits on the degree of travel are from approximately 0 to 500 degrees. The smallest arc is limited by the precision of the fit of the rack and spur gears, while the largest arc is limited by the throw allowed in the eccentric arm and rack.

Arcs larger than 360 degrees are useful when checking assemblies having a rotating component, which is connected through some type of gear train to a control knob. An example of this is the tuning assembly of a radio tuner, which is usually geared down for the purpose of finer tuning adjustments. To facilitate adjustment, a pointer and calibrated circle are attached to one



When specifications call for—

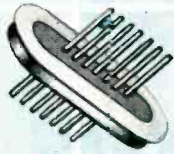

**glass-to-metal
seals***

E-I

offers—



9 MAJOR DESIGN ADVANTAGES

- ① CUSHIONED GLASS CONSTRUCTION
- ② DESIGN STANDARDIZATION
- ③ HIGH DIELECTRIC STRENGTH
- ④ VACUUM TIGHT SEALING
- ⑤ MINIATURIZATION
- ⑥ SUPER DURABILITY
- ⑦ VIBRATION RESISTANCE
- ⑧ MAXIMUM RIGIDITY
- ⑨ ECONOMY AND PROMPT DELIVERY

Check your requirements with sealed terminal specialists! Electrical Industries *specializes* in the design and manufacture of sealed terminations for all types of electronic and electrical components. Both standard and custom terminals can be supplied quickly to meet every design specification and the severest environmental condition. In most cases, specifications can be met with standard types that offer maximum economy and fast delivery!

Consult E-I First

— for Compression Seals, Multiple Headers, Sealed Terminals, Condenser End Seals, Threaded Seals, Transistor Closures, Miniature Closures and Color Coded Terminals — one dependable source for all hermetically sealed terminal requirements!



**ELECTRICAL
INDUSTRIES**

DIVISION OF AMPEREX ELECTRONIC CORPORATION
44 SUMMER AVENUE, NEWARK 4, NEW JERSEY

*PATENT PENDING—ALL RIGHTS RESERVED

AT LAST!

Rugged Field Voltmeter Measures 20 CPS to 1 MC; $\pm 5\%$ Accuracy!



**Temperature stable 0 to
120° F**

5" high, weighs just 32 oz.

Rugged printed circuits

**Battery powered; 1 mv
sensitivity**

New TRANSISTORIZED ALTO D-21 AC Voltmeter

Now—whenever you want—you have voltage measurements of laboratory accuracy and amazing convenience—without need for an ac power source.

From 20 cps to 1 MC, the revolutionary Alto D-21 provides highest accuracy, up to 1 millivolt sensitivity and complete temperature stability from 0 to 120° F. 12 decade ranges, front panel meter readings direct in db from -20 to +2 db, volts 0 to 1 or 0 to 3. Battery powered, 35 hours continuous duty. Output terminals for monitoring with 10,000 ohm and higher impedance devices. Printed circuits, transistors and heavy duty, shock-proof plastic case insure ruggedness, long life and dependability under most demanding field use.

SPECIFICATIONS

Frequency Range: 20 cps to 1MC.

Sensitivity: Max. 0.1 mv; min. 0.300 v
(12 ranges, 10 db steps).

Input Impedance: 10 megohms, 15 μ mf
shunt, 1 to 300 v; 30 μ mf shunt, 1 to
300 mv.

Accuracy: $\pm 5\%$ full scale.

Temperature Range: Stable 0 to 120° F.

Meter Calibration: Linear volt scale, 0-1,
0-3. Db -20 to +2 db each range.

Size: 5" x 3 1/4" x 3 1/4"; weight 32 oz.

Price: \$250.00.

Subminiature Square Wave Generator

Only 6" long, this amazing new addition to Alto subminiature line provides square waves from 300 to 3,000 cps, rise time less than 2 μ sec. Also ideal for modulating signal generators. Completely transistorized, rugged, provides 90 v peak-peak open circuit or 70 v into 50 K load. Wt. 27 oz. Price, \$100.00.



Data subject to change without notice. Prices f.o.b. factory.

Write Today for Complete Details

ALTO SCIENTIFIC COMPANY

855 COMMERCIAL ST. • PALO ALTO, CALIFORNIA, U. S. A.
DAVENPORT 4-4733



PRODUCTION TECHNIQUES

(continued)

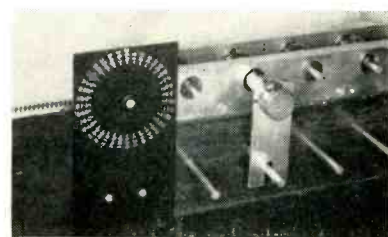

Floating mount for potentiometer eliminates side thrust

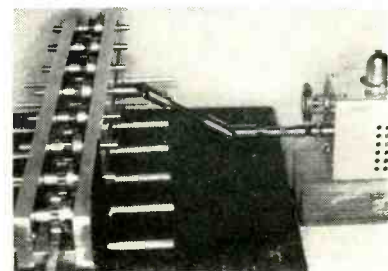

Universal joints eliminate side thrust when life-testing TV tubes

shaft to indicate degrees of rotation.

Speed of cycling is varied by controlling the voltage on a 1/25-hp, 5,000-rpm series motor with a 3-amp Variac. A 120:1 speed reducer is mounted on the motor. The speed range on this particular equipment is between 10 and 100 full cycles per minute. The number of elapsed cycles is measured on an impulse counter connected to a snap-action switch actuated by a cam on the motor shaft. Total count available is 999,999 cycles.

The entire unit is mounted on a plywood base $\frac{3}{4}$ x 15 x 32 inches, with fourteen shafts readily available for attaching components to be tested. The motor will develop enough torque to swing fourteen light components such as potentiometers and variable capacitors.

For light components normally supported by their shafts, the component is held only by the shaft and is free of any side thrusts, except for the weight of the component and bracket, which is negligible. With larger components or assemblies, too large to be supported by this shaft, two $\frac{1}{4}$ -inch universal joints are used to eliminate side thrusts.

If a component under test freezes and refuses to turn, the sleeve connecting the component to the machine will slip on the machine shaft or the additional load will stall the machine.

Sometimes it may be desirable

electronic engineers:

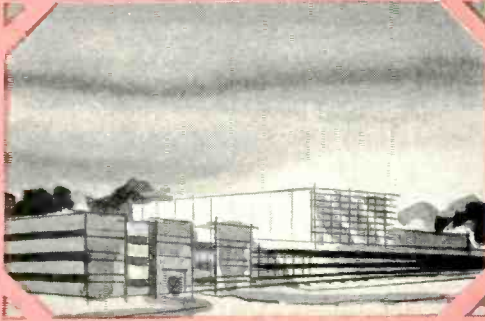

REASON 1

Interesting, creative work in modern, expanding facilities . . . Association with electronics industry leaders . . . Top income, excellent advancement opportunity.



REASON 2

Advanced education at company expense at the Johns Hopkins University or the University of Maryland.

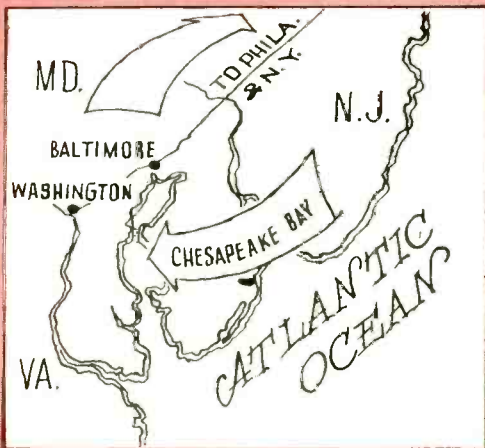

REASON 3

Ideal geographic location in the beautiful Chesapeake Bay country . . . 38 miles from the Nation's Capital, 198 miles from New York.

YOU CAN BE **SURE**...IF IT'S
Westinghouse

Here's Why So Many
EXPERIENCED
ENGINEERS
choose

Westinghouse

BALTIMORE DIVISIONS

Who is joining Westinghouse? Experienced engineers in the fields of — CIRCUITRY • MICROWAVES • SERVOMECHANISMS • PACKAGING • VIBRATION • TRANSFORMERS • FIRE CONTROL • RADAR • COMPUTER DESIGN AND PROGRAMMING.

Why do they prefer Westinghouse? An ideal combination of interesting long-range advanced development work, top income and outstanding benefits has led to this preference among experienced electronic engineers for the Westinghouse Baltimore Divisions.

Are full details available? A full description of the projects, opportunities, professional recognition and benefits of professional employment at Westinghouse is contained in our 24-page brochure, "Gateway to an Engineering Future." Send for your copy *today!*

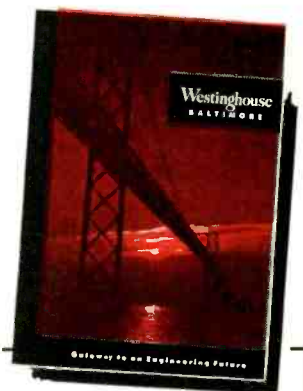

Technical Director, Dept. 265
Westinghouse Electric Corporation
2519 Wilkens Avenue
Baltimore 3, Maryland

Gentlemen:

Please forward at once a copy of your brochure . . . "Gateway to an Engineering Future."

Name

Address

City Zone State

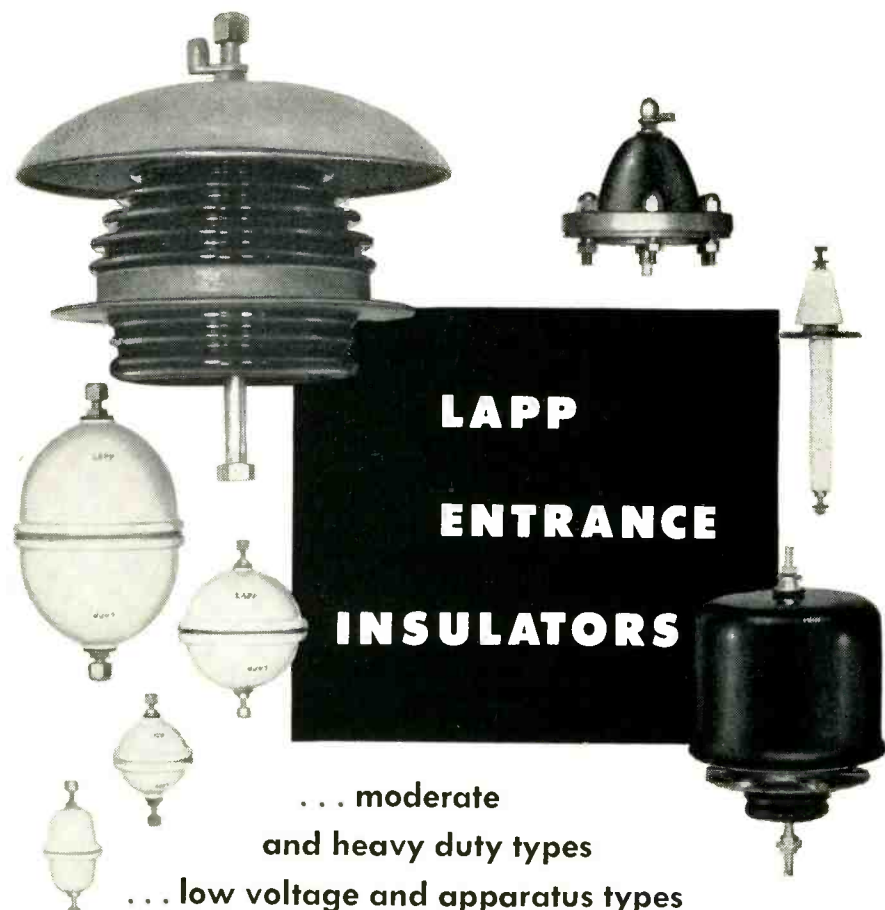

**LAPP
ENTRANCE
INSULATORS**

... moderate
and heavy duty types

... low voltage and apparatus types

A design which uses air as major insulation, with leakage path lengthened by forming porcelain into a bowl, eliminates losses which occur in ordinary types of bushings at radio frequency.

Lapp moderate duty insulators, suitable for a variety of low or medium voltage applications, are the standard type bowls for carrying leads through shields, equipment cases, walls, etc., and practically any indoor use where duty is not too severe.

Outdoor units are designed with corrugated surfaces which provide extra leakage distance for use in contaminated atmosphere. Corrosion-resistant hardware.

A wide variety of types of these insulators is now available as catalog items . . . or where requirements necessitate, on special design—for which Lapp engineering and production facilities are excellently qualified. Write for complete descriptive data and specifications. Lapp Insulator Co., Inc., Radio Specialties Division, 243 Sumner Street, Le Roy, N. Y.



to place weights on the mounting bracket to simulate a side thrust placed on a control by a belt-and-pulley arrangement. Nearly always it is necessary to supply rated electrical conditions to the unit under test to evaluate fully the expected life.

Cutting Tapered Cards for Precision Potentiometers



Placing resistor card in position on cutting anvils. Hole in left end of card, fitting over positioning peg, is cut off along with surplus length at other end of card

A BENCH tool developed in the Hicksville, N. Y. plant of Fairchild Controls Corp. accurately cuts wound cards to specified length within a tolerance of five thousandths of an inch, yet can be quickly reset to a new value. The operator merely places the wound card over a positioning peg on the cutting anvil, then brings down a spring-loaded overhead lever to shear off the ends of the card so it will fit precisely when bent into a circle for insertion in the housing of a precision potentiometer.

The setup procedure involves removing a positioning pin and sliding the left-hand anvil and blade assembly along the ways to a hole marked within the integral inch of the desired length value. The pin is then pushed through the anvil into the drill bushing set into that hole.

A micrometer on the right-hand side of the tool is then set to the exact decimal-inch value desired, moving the other anvil and blade. This section is spring-loaded

International Rectifier

Selenium and Germanium Rectifiers

International Selenium Products

Pressed powder or vacuum process used as determined by our Applications Engineering Dept. The most widely used Industrial Power Rectifiers in Industry today!

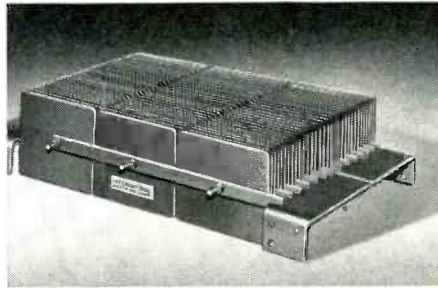

INDUSTRIAL POWER RECTIFIERS

For all DC power needs from microwatts to kilowatts. Features: long life; compact, light weight and low initial cost. Ratings: to 250 KW, 50 ma to 2,300 amperes and up. 6 volts to 30,000 volts and up. Efficiency to 87%. Power factor to 95%. **Bulletin C-349**

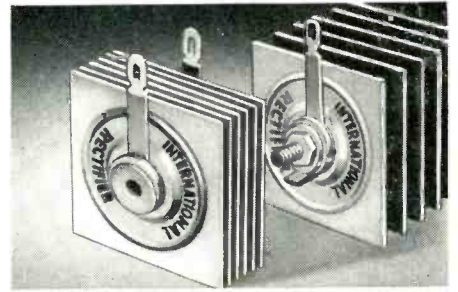

TV AND RADIO RECTIFIERS

The widest range in the industry! Designed for Radio, Television, TV booster, UHF converter and experimental applications. Input ratings from 25 to 195 volts AC and up. DC output current 10 to 1,200 MA. Write for application information. **Bulletin ER-178-A**



HIGH VOLTAGE CARTRIDGE RECTIFIERS

Designed for long life and reliability in Half-Wave, Voltage Doubler, Bridge, Center-Tap Circuits, and 3-Phase Circuit Types. Phenolic Cartridge and Hermetically Sealed types available. Operating temperature range: -65°C to $+100^{\circ}\text{C}$. Specify **Bulletin H-2**

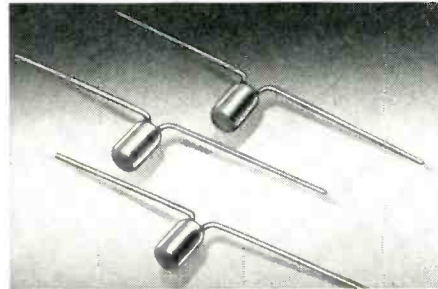

SUB-MINIATURE SELENIUM DIODES

Developed for use in limited space at ambient temperatures ranging from -50°C to $+100^{\circ}\text{C}$. Encapsulated to resist adverse environmental conditions. Output voltages from 20 to 160 volts; output currents of 100 microamperes to 11 MA. **Bulletin SD-1B**

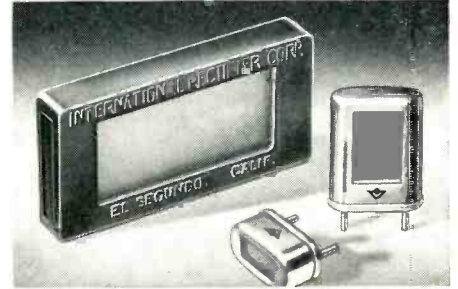

PHOTOELECTRIC CELLS

Self-generating photocells available in standard or custom sizes, mounted or unmounted. Optimum load resistance range: 10 to 10,000 ohms. Output from .2 MA to 60 MA in ave. sunlight. Ambient temperature range: -65°C to $+100^{\circ}\text{C}$. **Bulletin PC 649**

International Germanium Products

High quality units of improved design are the results of years of experience in the production of exceptionally fine germanium crystals plus extensive research, development and field performance testing!

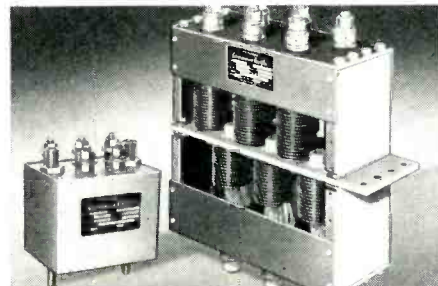

GERMANIUM POWER RECTIFIERS

This new line features: High efficiency—up to 97%, Lowest forward drop, High reverse to forward current ratio, unlimited life expectancy. No reforming required after storage. Ratings: 26 to 66 AC input v. per junction: 150 to 100,000 amps DC output. Operating temperature range: -55°C to $+75^{\circ}\text{C}$. In three styles. **Bulletin GPR-1**

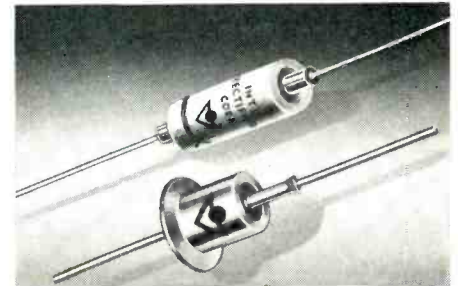

GERMANIUM DIODES

POINT CONTACT. High quality crystals—long reliable life—superior resistance to humidity, shock, temp.-cycling. **Bulletin GD-2**
JUNCTION POWER. Hermetically sealed—welded construction. Available in Standard JETEC 1N91, 1N92, 1N93 types. For diodes to meet your specific requirements, consult our Semiconductor Division.

a world of difference through research!



For bulletins on products described WRITE ON YOUR LETTERHEAD to our PRODUCT INFORMATION DEPARTMENT

International Rectifier

C O R P O R A T I O N

EXECUTIVE OFFICES: 1521 E. GRAND AVE., EL SEGUNDO, CALIFORNIA • PHONE OREGON 8-6281

WORLD'S LARGEST SUPPLIER OF INDUSTRIAL METALLIC RECTIFIERS

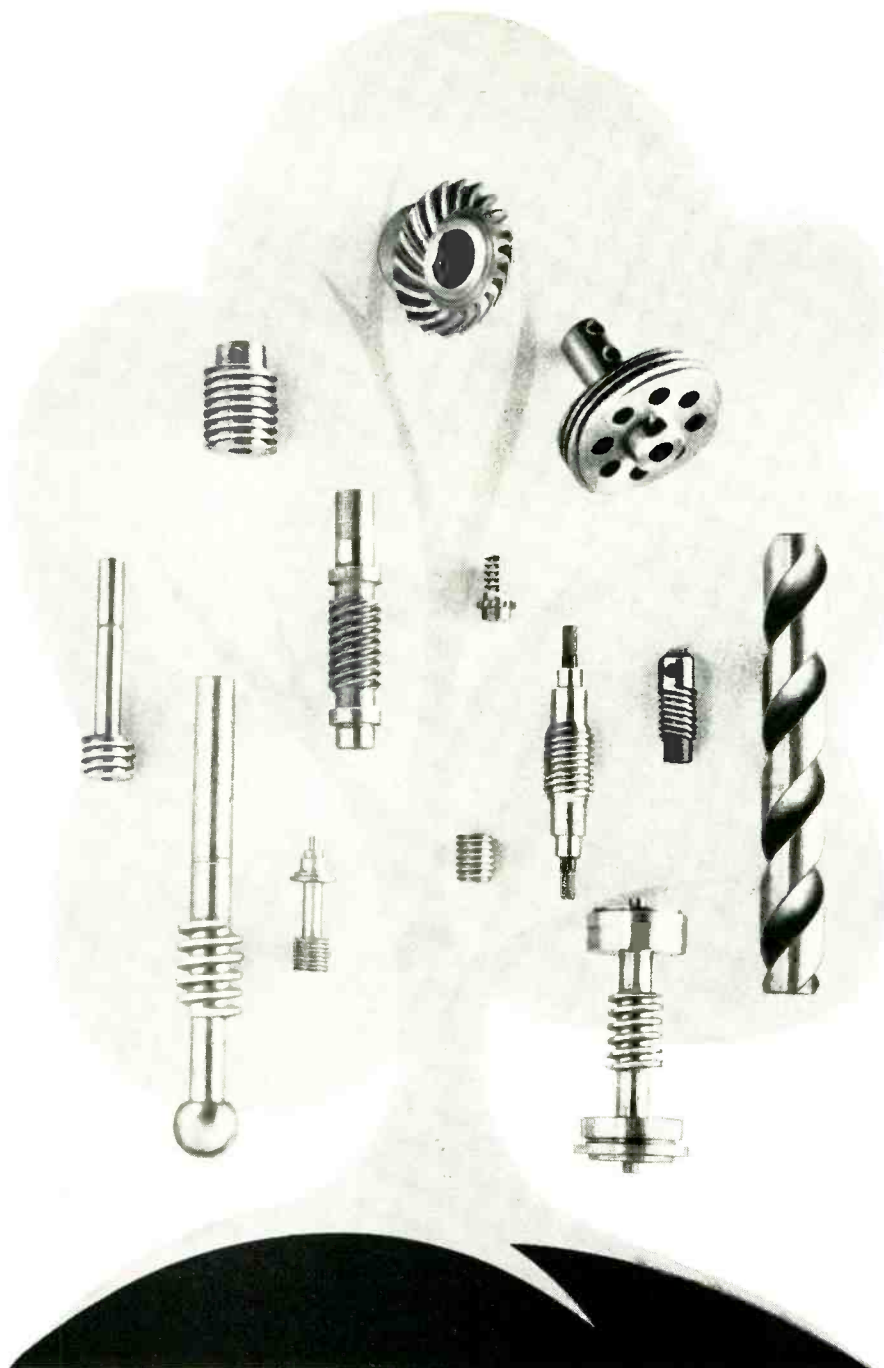

Placing positioning pin of left-hand anvil-blade unit in 4-inch position hole on bed of tool, as initial step in setting cutting blades for desired length of cut

against the micrometer to give the required accuracy.

The third setup step involves placing a card on the positioning peg, then loosening a set-screw and sliding this peg to locate the two cuts where they will give maximum strength to the card. The steel cross-bar on the handle slides freely in the left-hand blade arm, to permit this change in cutting length.

The cutting blades are of hardened steel, ground razor-sharp. This gives a smoothly sheared edge on the paper-base phenolic that serves as the winding card for a linear or nonlinear unit.



Adjusting micrometer to set right-hand anvil-blade combination to desired thousandth of inch

THE FRUITS OF "KNOW HOW"

- ★ HARDENED AND GROUND GEARS
- ★ MASTER GEARS AND INVOLUTE SPLINE GAUGES
- ★ CONIFLEX AND SPIRAL BEVEL GEARS
- ★ THREAD GROUND WORMS
- ★ GEAR ASSEMBLIES

QUAKER CITY GEAR WORKS

INCORPORATED

BETHAYRES, PA., CHAPEL HILL 0800

FOR A WORLD OF TOMORROW

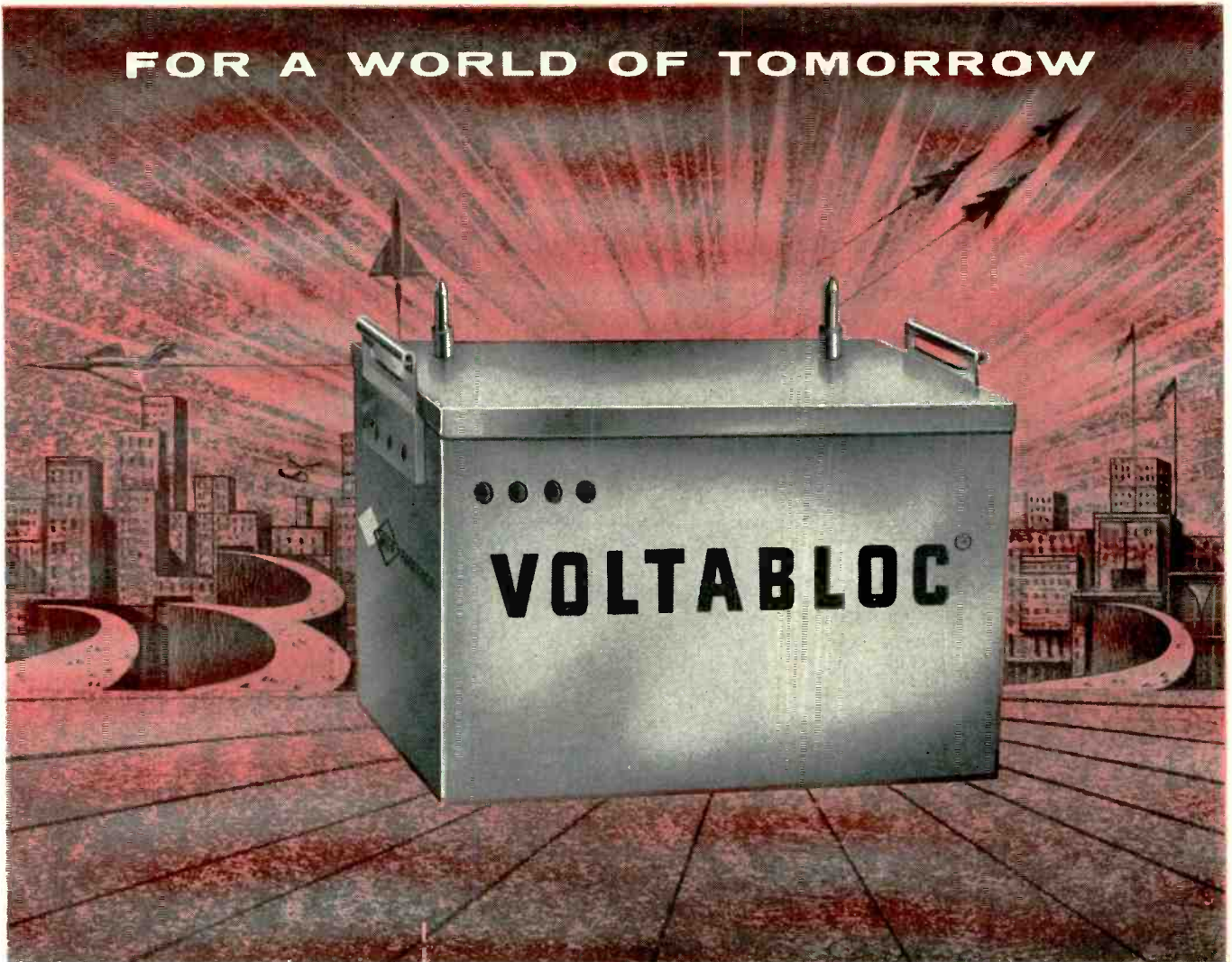

V O L T A B L O C[®]

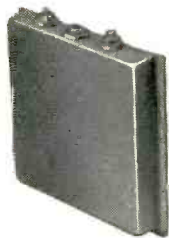

- repeated peak discharge rates up to 20C
- high sustained discharge rates
- unharmed by short-circuit
- withstands severe shock and vibration
- hermetically sealed, no gassing—leakproof
- requires no maintenance
- outlasts conventional batteries 5 to 1

—The Hermetically Sealed Battery
DOES MORE
DOES IT BETTER

Every function that a battery can perform, from the smallest to the largest, can be done better — more dependably — longer, as a result of this great new development in battery construction.

The secret lies in the new VOLTABLOC[®] patented construction with sintered nickel and cadmium plates tightly compressed in a hermetically sealed metal case.

VOLTABLOC[®] new type batteries give you an entirely new conception of battery service and economy. Send today for complete information on your specific applications. Write to SAFT Corporation of America, 2 Gregg Street, Lodi, N. J., for Bulletin #300.

A complete line from 0.8 a.h. to largest peak discharge requirements.

©NTI



AMERICA

New Products

Edited by WILLIAM P. O'BRIEN

86 New Products and 51 Manufacturers' Bulletins Are Reviewed
. . . Control, Testing and Measuring Equipment Described and
Illustrated . . . Recent Tubes and Components Are Covered

HIGH-SPEED RECORDER

logs any changing variable

MINNEAPOLIS-HONEYWELL REGULATOR Co., Industrial Division 4428 Wayne Ave., Philadelphia 44, Pa. A high-speed electronic recorder, capable of logging any changing variable literally within a split second, has been developed. The strip chart instrument requires only $\frac{1}{4}$ sec for its pen to cover the full 11-in. chart width. It was designed primarily for research

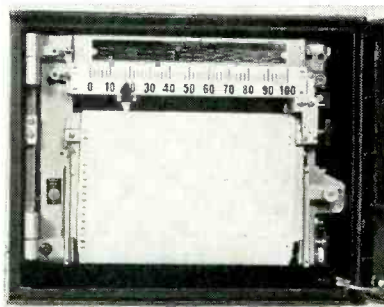

centers, laboratories and experimental stations where emphasis is on high-speed measurement and charting of changing conditions which can be measured by d-c output transducers. The amplifier of the new recorder has a high input impedance and increased output power. It is of plug-in construction. A manual pen lifter prevents ink clogging or tearing of chart paper. Accelerated chart speeds, appropriate to the split-second pen speed, are available.

ELECTRONIC COUNTER

features small size

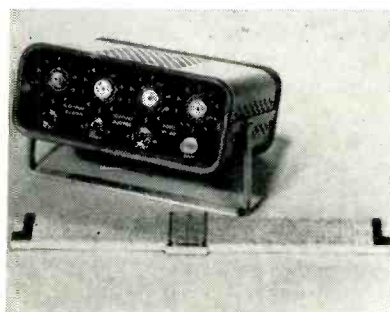

WESTPORT ELECTRIC, 149 Lomita St., El Segundo, Calif. Model WE-610 is a portable, 4-decade, electronic counter featuring small size (3 models can be mounted side-by-side in a $3\frac{1}{2}$ by 19-in. panel) and light-weight construction (6 lb complete, 12 oz without power supply). Combination of glow transfer tubes and simplified circuitry results in an attractive unit which is

reliable and long lived despite its small size and relatively low cost. When using 60-cycle power frequency as a time base this unit can be used to calibrate timing devices such as x-ray timers, relays and actuators. Because of its high counting rate it makes an excellent radiation counter, and in conjunction with an external timer, an ideal radiation rate meter. Response is 0 to 5,000 pps; maximum indicated count, 10,000 units; sensitivity, 50 mv rms.

SWEEP GENERATOR

operates automatically

CHADWICK-HELMUTH Co., P.O. Box 321, Monrovia, Calif. The new Sweep-Sync, model 201, produces linear horizontal sweep on oscilloscopes for the display of a selected number of cycles on the vertical axis signal. This number, once set by a front panel control, remains constant over the sweep rates 5 cps to 100 kc automatically, and no adjustments are required for changes in signal amplitude or frequency. The instrument is designed to be used in sine wave or pulse testing



where frequency or prr variations make conventional procedures inadequate. Features include complete printed wiring and miniaturization, small size occupying only 4 in. of front panel width, and cabinet design allowing access to all parts with no disassembly.

CAPACITORS of the flat Mylar type

SANDERS ASSOCIATES, INC., Nashua, N. H. Type KFM series of flat Mylar capacitors can readily be used

Closest thing yet to zero hum level

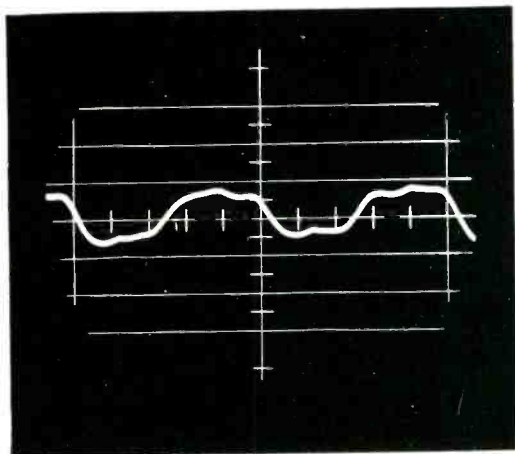

Standard audio preamp tube

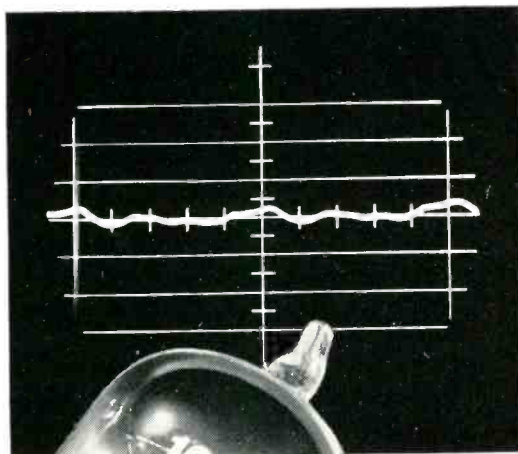

The new 12AD7

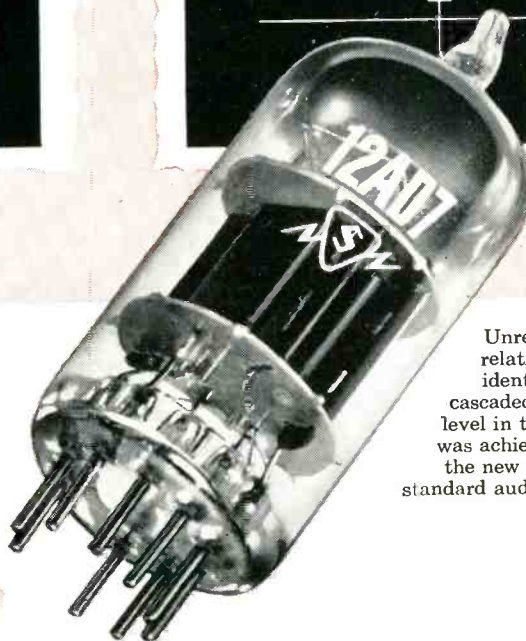

Unretouched oscillograms show relative hum levels taken under identical conditions in a typical cascaded preamp circuit. Low hum level in the oscillogram on the right was achieved simply by substituting the new Sylvania type 12AD7 for a standard audio preamp tube.

Sylvania 12AD7...the low-hum, low-micro preamp tube you've been waiting for

Sylvania has been working two full years to bring you an audio preamp tube with exceptionally low hum and micro characteristics. It is a 9-pin miniature, high mu (100) double triode.

You can incorporate the new 12AD7 into both existing and new audio equip-

ment designs . . . with improved performance.

The 12AD7 reduces cost of incoming inspection for low hum. That's because the 12AD7 has been circuit designed, and circuit tested for minimum hum and microphonism.

Write for complete details on the new 12AD7 plus these other important Sylvania audio tube types

6SN7GTA	6L6GB
12AU7A	6V6GT
	12AX7



SYLVANIA®

SYLVANIA ELECTRIC PRODUCTS INC.
1740 Broadway, New York 19, N. Y.
In Canada: Sylvania Electric (Canada) Ltd.
University Tower Bldg., Montreal

LIGHTING • RADIO • ELECTRONICS • TELEVISION • ATOMIC ENERGY

with printed circuits and automatic assembly processes. All sizes are supplied with 2 sets of parallel leads for convenient mounting. They are made of Mylar polyester film dielectric material and are encapsulated in high quality Kel-F. This con-

struction provides a moisture seal, and stable operating characteristics over a wide temperature range. Multiple lead wires, securely attached to capacitor foils and held rigidly in place by a Kel-F seal, permit varied arrangements of lead connections

and reliable attachment to printed circuit baseplates and modular wafers. Standard sizes are rated at 150 and 250 v d-c working at 125 C. For use at 85 C and below, these ratings are increased to 250 and 350 v d-cw respectively.

TERMINAL EQUIPMENT

for control signals

RADIO FREQUENCY LABORATORIES INC., Powerville Rd., Boonton, N. J. Model 983 Voicon terminal is used for the transmission and reception of control signals over an in-use telephone channel without impairing the quality of the speech. Primarily designed for use by airlines to control unattended slave radio stations, it is equally useful for many industrial applications. Two tone channels are placed above 2,400 cps and are isolated with respect to the voice circuit by voice bandpass filters. Model 983 is ap-

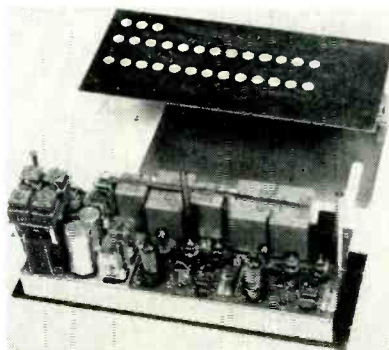

licable to microwave and power line carrier voice channels as well as those derived on physical pairs.

The equipment consists of a 2-channel frequency shift tone transmitter and a 2-channel frequency shift tone receiver, each with power supply, voice band-pass filters and isolation transformers. Each receiver channel is provided with a dpdt relay in its output circuit. Relay contacts are rated at 2 amperes for direct connection to the controlled function, stepping switches, or power relays. Design of the equipment provides fail-safe operation in the event of signal or equipment failure. The basic terminal provides for 2 control channels with center frequencies of 2,800 and 3,000 cps.

RESISTOR ASSEMBLY

thermally similar

CLAROSTAT MFG. Co., INC., Dover, N. H., has announced a method of encapsulating two precision deposited carbon resistors with nearly identical temperature coefficients in a single enclosure to provide highly similar thermal conditions within the capsule as

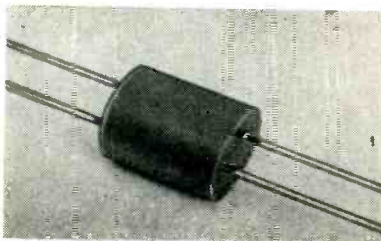

the ambient temperatures vary. The newly developed thermally similar resistor assembly has been designed to meet the needs of those applications requiring identical resistance change characteristics, such as in color tv, electronic computers, specialized test equipment and guided missile controls, where accurate balancing of circuitry is required.

AUTOMATIC IRIS

for industrial tv camera

RADIO CORP. OF AMERICA, Camden, N. J. Developed for use with the ITV-6 closed-circuit system, the iris illustrated automatically provides constant lighting for the camera's Vidicon pickup tube regardless of external light levels. The iris mechanism automatically masks the lens with the proper filter for any given external light condition. In much the same manner that a phototube responds to light, the camera's Vidicon pickup tube responds to the intensity of external light striking it. With



corresponding intensity, the Vidicon activates the iris control mechanism which, in turn, triggers the motor regulators on the camera. The motors automatically unreel the film between the lens and the Vidicon tube until the filter of proper density is in place.

R-F FITTINGS made of magnesium

MODEL ENGINEERING AND MFG., INC., 65 Frederick St., Huntington, Ind., has developed and produced magnesium fittings fabricated

Now available

the revolutionary
ELECTRO TEC
 process* for your
LARGE
SLIP RING
ASSEMBLIES

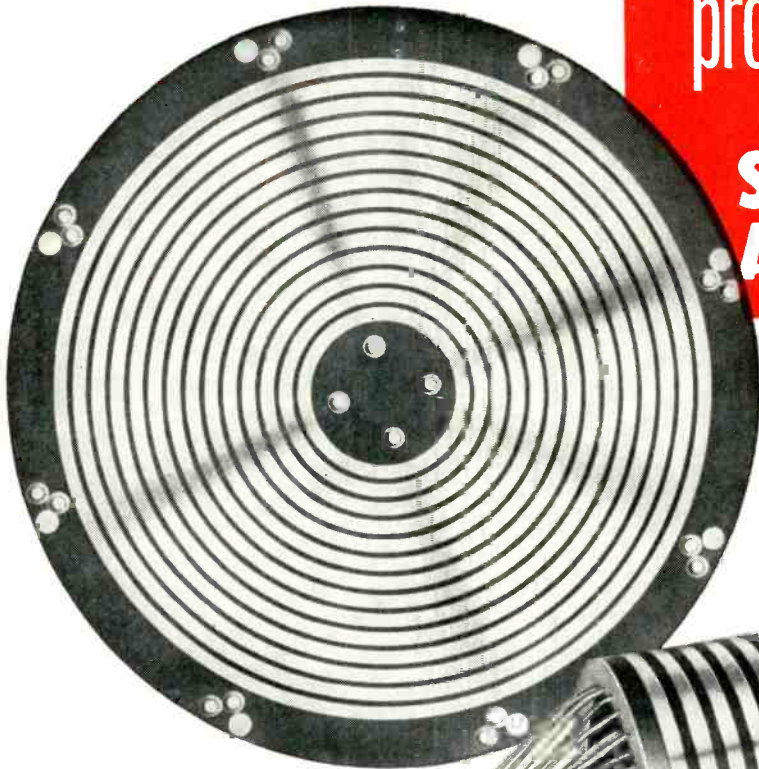

◆ An assembly with 14 concentric, hard silver rings electro deposited into machined plastic blank. Dovetail locks rings in place. Machined blank insures accuracy. Diameter approx. 11", thickness approx. 5/16".

◆ Cylindrical assembly with 25 rings. Three wide rings accommodate large contact brushes for high current capacity. Length 14", O.D. approx. 5 3/8".

◆ An assembly with 30 rings of various widths to accommodate various current requirements. Unit is approx. 4-5/16" long, designed for flange mounting.

◆ Cylinder type assembly approx. 3 3/4" long with 24 hard silver rings. 1 5/8" O.D. with wall thickness less than 1/4".



*PAT. NO.
2,696,570

Our Engineering Department is available for consultation on any of your slip ring problems without obligation.



ELECTRO TEC CORPORATION
 SOUTH HACKENSACK • NEW JERSEY

featuring

- LOWER COST • CLOSER TOLERANCES
- ONE-PIECE CONSTRUCTION • JEWEL-LIKE FINISH • UNIFORM RING HARDNESS
- REDUCED WEIGHT



**Now a Complete Service
 in all sizes of Slip Ring Assemblies**

ELECTRO TEC is now tooled up, with new expanded facilities for production of large Slip Ring Assemblies to exact customer specification. Sizes range up to 36" in diameter, either cylindrical or disc type.

The exclusive ELECTRO TEC PROCESS*—the electro-deposition of hard silver rings into an accurately machined plastic blank—consistently yields a high degree of dimensional accuracy, excellent concentricity, and a jewel-like ring finish. This process also eliminates expensive tooling and mold charges, frequently lowers costs to 30% of other methods of manufacture. The silver rings are uniformly hard for long life—70-95 Brinell.

ELECTRO TEC one-piece construction precludes dimensional variation due to accumulated errors. The plastic base is fully cured before rings are plated into it, thus preventing separation of base material from the rings.

ELECTRO TEC LARGE SLIP RING Assemblies are widely used in Radar Equipment, Fire Control Systems, Test Tables and many other critical applications. Light weight combined with rugged durability recommends their use in airborne applications.

Every user knows the ELECTRO TEC reputation for quality and superiority in miniature and sub-miniature slip ring assemblies.



is
that

PHILLIP'S or PHILLIPS?"

Your first "here's-my-problem" letter to Phillips will bring you a pleasant surprise. It will introduce you to the *Phillips Plan* . . . a combination of engineering skill* and personal service unique in this field. Why not write us today—Phillips is the name. Or phone for your local Phillips man to call.

*
FOR EXAMPLE:
Phillips Engineered Relays provide the long life and extreme reliability required by today's high speed computers.



TYPE 4BQA — Miniature multi-contact relay; high speed, sensitive, available with printed circuit or taper tabs. O.D. 1-11/16" L x 1 1/8" W

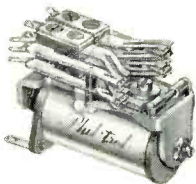

TYPE 8QA — Multi-contact relay with twin contacts; highly sensitive, long lived, precision operation, available with taper tabs. O.D. 2-7/32" L x 1-3/32" W

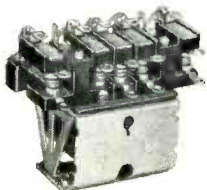

TYPE 27QA — Power relay; five pole, two coils for high efficiency; very rugged, small size, commonly used for aircraft. O.D. 2-17/32" W x 2 1/8" H x 1 1/8" L

MULTI-CONTACT, POWER, HERMETICALLY SEALED RELAYS - ACTUATORS

PHILLIPS

PHILLIPS CONTROL CORPORATION . . . JOLIET, ILLINOIS

SALES OFFICES: NEW YORK - PHILADELPHIA - BUFFALO - SAN FRANCISCO
DENVER - ATLANTA - DETROIT - CLEVELAND - DALLAS - SEATTLE

NEW PRODUCTS

(continued)

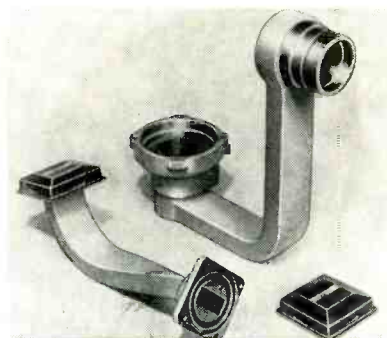

from RG-170/U, RG-171/U and RG-172/U waveguides, and equivalent respectively to RG-68/U and RG-67/U (both aluminum), and RG-91/U (brass). Besides these three standard sizes, the firm is also making special Tru-Guide magnesium waveguides for non-standard or custom applications. The magnesium components, which are $\frac{3}{4}$ as heavy as aluminum and $\frac{1}{4}$ as heavy as brass, possess higher strength-to-weight ratios than the heavier metals. They conform to military specification MIL-T-85C. A special approved coating process imparts maximum resistance to corrosion and electrolytic action, without impairing physical or electrical performance. Standard sizes are available in any configurations of E and H bends, twists, and lengths up to 10 ft, mounted to any type flange.



POWER SUPPLIES are semiregulated

NJE CORP., 345 Carnegie Ave., Kenilworth, N. J. The ELG line of semiregulated power supplies employ germanium power rectifiers in conjunction with automatic line-regulating transformers and extremely stiff transformers and filters. In most models efficiency is of the order of 94 percent. Average temperature rise is 5 C. Circuitry is extremely simple, and no component is rated at less than 30,000 hr of continuous duty. A typical unit delivers 100 v at 2

November, 1955 — ELECTRONICS

DEVELOPED FOR APPLICATIONS, ...

... beyond today's horizons

Today's design requirements foreshadow tomorrow's revolutionary applications... imposing critical new areas of performance on electronic components.

The vexing problem of efficient capacitor and R.F. filter operation under these ultra-severe conditions of extreme heat, cold, moisture and vibration challenges the imagination of the component manufacturer... Truly he must create "something completely new under the sun"!

A foremost pioneer in the exacting development of advance-design components, to cope with these requirements, is Astron... leader in miniaturization, manufacturer of industry's widest variety of types, whose experience, ability and creative far-reaching point of view produces the significant, highly-engineered designs pictured here... proof of a dedication to progress.

The types and styles illustrated are but a few of the many available... for complete technical and application information on all Astron products, please request catalog AC-4.

New HEIGHTS OF PERFORMANCE
Achieved by advance-design
ASTRON CAPACITORS AND R.F. FILTERS

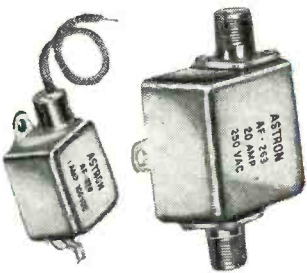

R. F. Noise Suppression Filters.
Complete noise suppression "Packaged" service—Definition of requirements • Engineering analysis • Efficient solutions • Advance-type components • Quality production.

Attention: West Coast Buyers
Astron now maintains a complete West Coast Stock of all standard items... see your local Astron distributor.



Blue • Point® Molded Plastic Paper Capacitors



Comet* Molded Plastic Metallized Paper Capacitors

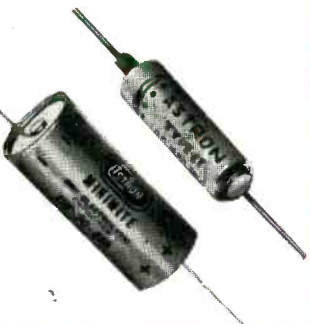

Safety Margin "SM"* Miniature Electrolytic Capacitors



Meteor® High Temperature Miniaturized Capacitors

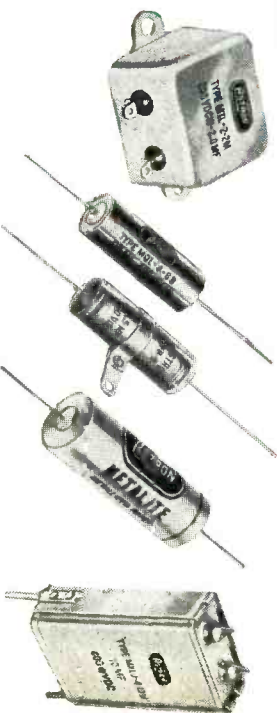

Metalite® and Hy-Met* Sub-Miniature Metallized Paper Capacitors

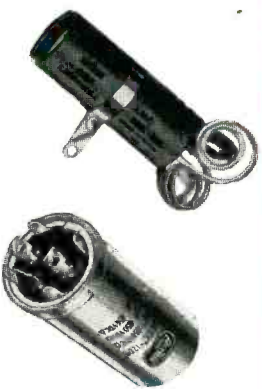

Safety Margin "SM"* Twist Prong and Cardboard Cased Electrolytic Capacitors



MIL-Type Hermetically Sealed Paper Capacitors

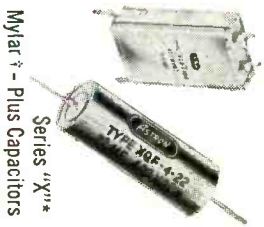

Series "X"* Mylar* - Plus Capacitors



ASTRON CORPORATION
255 GRANT AVENUE EAST NEWARK, N. J.

Export Division: Astron International Corp., 13 E. 40th St., N. Y. C.

In Canada: Charles W. Peinton, 6 Altona Ave., Toronto 10.

Reg. Du Pont Trademark
Trademark

COAXWITCH

COAXIAL SELECTOR SWITCH

50 Ohms —
Type N Connectors—Manually Controlled
Low VSWR—4 Models

CUT-A-WAY VIEW, MODEL 74

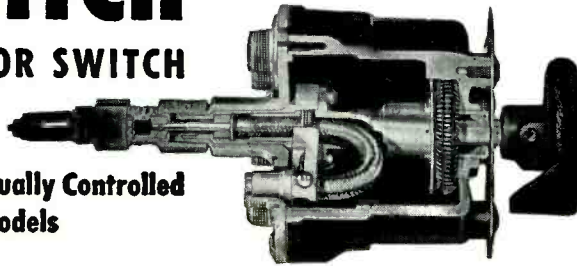

The COAXWITCH is an RF switch for use in coaxial circuits where it is important that the 50 OHM impedance of the cables be maintained. In a circuit sense, this switch consists of two pairs of "N" connectors spaced 4 1/2" apart using RG-8/U as the connecting link. The COAXWITCH itself introduces no VSWR other than that of connectors. Characteristic impedance is maintained thru all switch details. Cut-

away view shows that shield as well as center conductor is switched. Beryllium copper contacts, on the gooseneck, mate directly with male "N" (Type UG-21B/U) connectors, which connect directly to back plate of switch. Since all connectors come out in line with axis of switch, right angle connectors are usually unnecessary.

Literature Gladly Sent

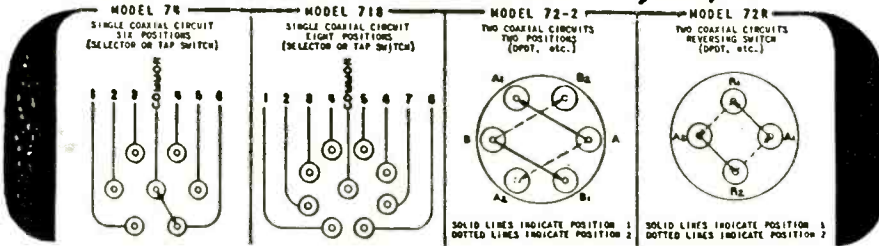

BIRD ELECTRONIC CORP.
1800 EAST 38TH ST., CLEVELAND 14, OHIO
TERMALINE Coaxial Line Instruments

VAN GROS COMPANY
Sherman Oaks, Cal.
RON MERRITT COMPANY
Seattle



ATOMIC'S INDUSTRIAL COUNTERS AND CONTROLLERS

with **UNITIZED CONSTRUCTION**

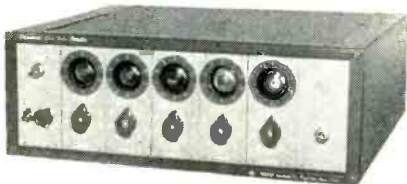

for

- Straight Counting
- Process Control
- Quality Control
- Specialized Counting

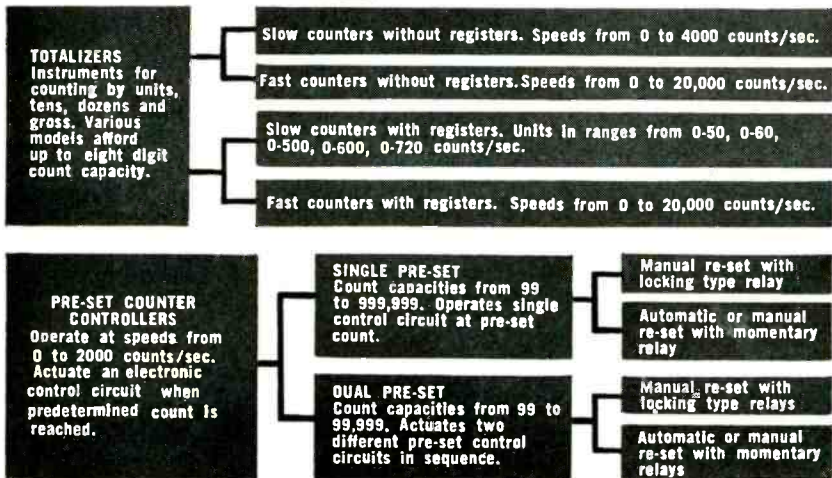

amperes, regulated to better than 1 percent against line and load changes, and has less than 0.1 percent rms ripple. Transient response is excellent, and most units can be economically designed for zero-lag response, so as to exhibit no transient deviation outside the regulated zone.



RADIO RECEIVER is all-transistorized

TOKYO TSUSHIN KOGYO, LTD., Shinagawa, Tokyo, Japan. The Sony TR-55 portable superheterodyne radio receiver uses 5 transistors and 4 penlight 6-v batteries. It is equipped with a 2.5-in. dynamic loud speaker. Weight of the unit is 560 grams; frequency range, 535 to 1,605 kc; practical field strength, 1 to 2 mv per meter; electrical maximum output, 20 mw; undistorted maximum output, 10 mw; and selectivity, approximately 15 decibels.

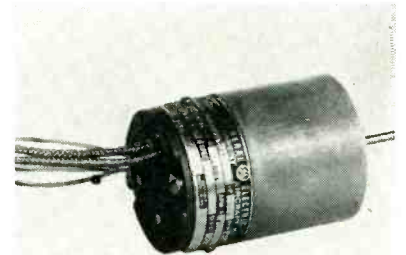

D-C SERVO MOTOR for aircraft applications

GENERAL ELECTRIC Co., Schenectady 5, N. Y., has announced a new miniature d-c servo motor capable of withstanding a high potential of 1,500 v and of responding to field currents of 0.0075 ampere. Suited for aircraft applications on blowers, actuators, tuners and

... please request Atomic's *Representatives in principal cities—U.S. and abroad*
Industrial Counting and Control Catalog C-6.

> Radioactivity Measurement Instrumentation
> Electronic Counting and Control Equipment

ATOMIC INSTRUMENT COMPANY
CAMBRIDGE 39, MASSACHUSETTS, U. S. A.

3 ways better...

One look tells you 3 ways this new Sylvania socket can help you produce a better printed circuit chassis

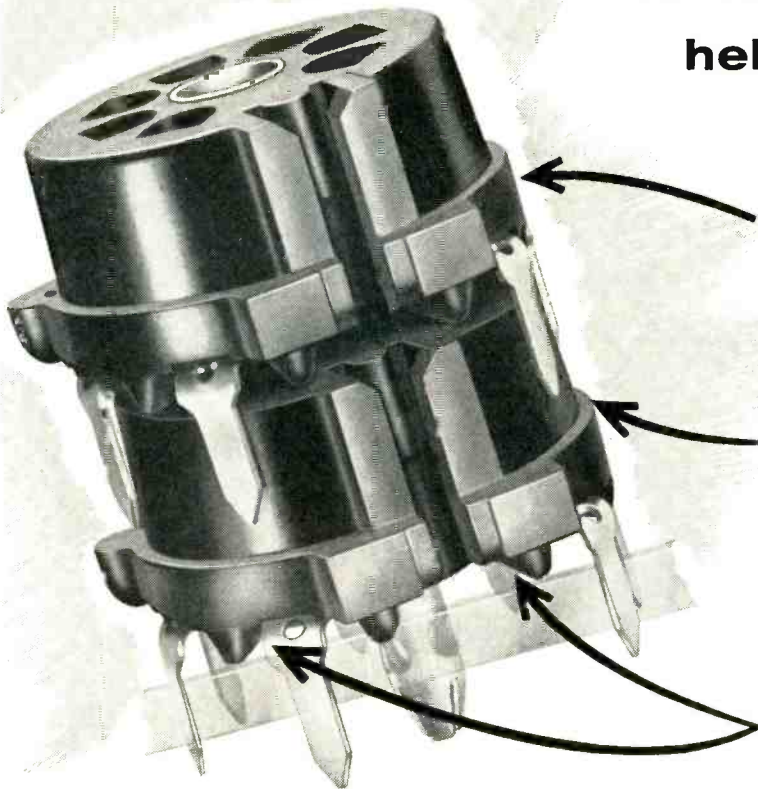

1. "It supports"

new collar design supports the metal tube shield isolating it from the printed circuit board and contact tails. Short circuits are eliminated.

2. "It stacks"

designed for foolproof nesting to accommodate automatic assembly techniques. Ground-strap slot keys sockets for proper orientation.

3. "It sits up"

contact-tail barriers keep the socket perched higher off the printed circuit board for greater heat dissipation and freedom from flux contamination.

← Available in 7- and 9-pin types



Sylvania printed circuit sockets offer you all the important advantages you need for design efficiency. You get freedom of layout. Contacts fit through smaller holes in the circuit board. You can arrange your circuits for shortest conductor paths.

Sylvania sockets are all-molded. Moisture traps are eliminated; insula-

tion qualities are higher. Contact characteristics are superior. Printed circuit production is more economical because Sylvania sockets are designed for automatic production methods.

Before you package your printed circuit design be sure you take a close look at these sockets. Write for data or samples. Address Dept. L20S.



SYLVANIA®

SYLVANIA ELECTRIC PRODUCTS INC.
1740 Broadway, New York 19, N. Y.
In Canada: Sylvania Electric (Canada) Ltd.
University Tower Bldg., Montreal

LIGHTING • RADIO • ELECTRONICS • TELEVISION • ATOMIC ENERGY

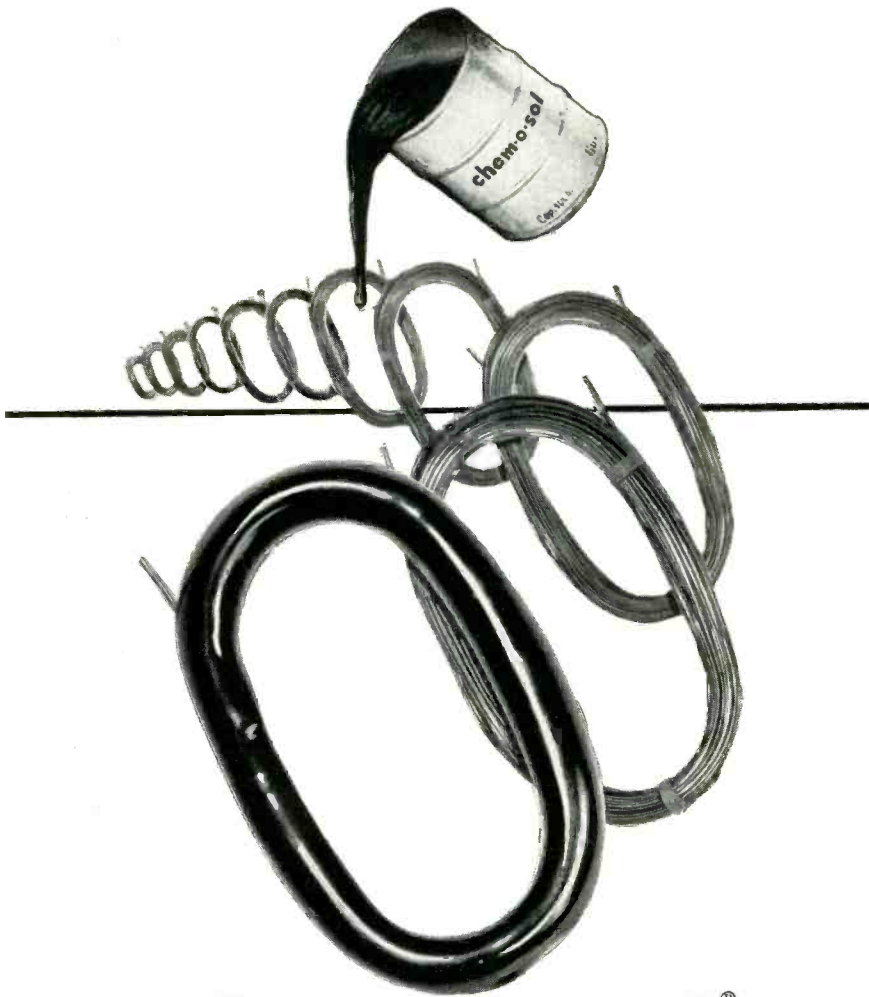

chem-o-sol[®]
(a plastisol formulation)

**solves another problem
by coating
ELECTRIC COILS**

Our client required a tough, abrasion-resistant insulation which could be quickly and economically applied to these motor coils. Our formulating knowledge and experience allowed us to give them a *chem-o-sol* which not only had the necessary electrical and physical properties but also could be handled on a production line basis.

This particular *chem-o-sol* was applied by dipping. But this versatile basic material can also be molded, sprayed, die-wiped, and knife- or roller-coated—and comes in practically any color.

The possibilities of new and improved products through the use of *chem-o-sol* are unlimited.

Take advantage of our experience and laboratory facilities.

Write for Bulletin 141

Chemical Products CORPORATION
KING PHILIP ROAD • EAST PROVIDENCE, R I



similar devices, the new motor will operate equally well at sea level or at 50,000-ft altitude and within temperature limits of -65 F to 165 F. It is also used as a prime mover in gun direction computer systems, electronic devices, and can be modified for other aircraft and missile applications. The new motor, designated 5BBY13DJ7, draws maximum armature current of 0.8 ampere from a 28-v line. It is rated at 0.002 hp at 6,500 rpm and can be geared to speeds as low as 130 rpm.

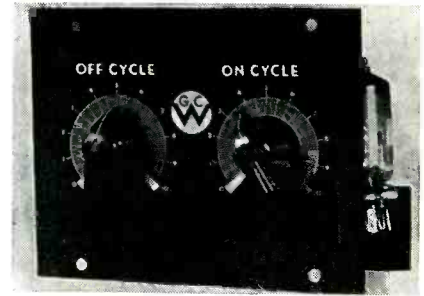

**REPEAT CYCLE TIMER
uses minimum power**

G. C. WILSON & Co., 1915 Eighth Ave., Huntington, West Virginia, has announced a new low cost electronic repeat cycle timer, suitable for design into automatic machines or for process control. Typical applications include sign flashing, life testing, bag filling, refluxing and automatic weighing. Design of the model No. 4 repeat cycle timer utilizes an electronic circuit with two cold-cathode triodes. No warmup is required and no filament power is consumed. Complete, independent adjustability of both ON and OFF cycles from 0.1 to 12 sec is provided. Output is a spdt relay with 5-ampere contacts.

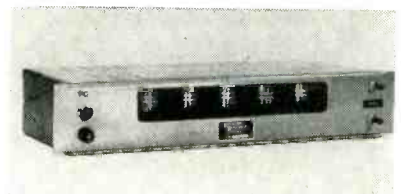

**ELECTRONIC COUNTER
features compactness**

RANSOM RESEARCH, P. O. Box 382, San Pedro, Calif. Type 200 series

BENDIX-PACIFIC SPECIALIZES IN AIRBORNE RADAR

WHICH IS YOUR RADAR REQUIREMENT?



**TERRAIN
CLEARANCE
RADAR**



**NAVIGATIONAL
RADAR**



**TAIL-WARNING
RADAR**



**MISSILE
GUIDANCE**



**MAPPING
RADAR**

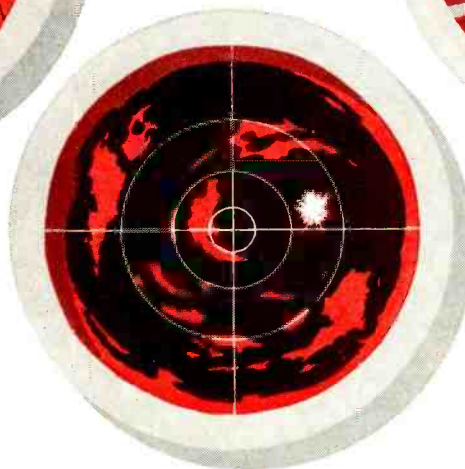

**RADAR
BEACONS**

Bendix-Pacific specializes in airborne radar, having design experience and manufacturing ability to develop and produce systems radar to meet your requirements.

Let us send a qualified radar systems engineer to visit you at your convenience.



EAST COAST OFFICE: 475 5th AVE., N.Y. 17 • **DAYTON, OHIO**—1207 AMERICAN BLDG., DAYTON 2, OHIO • **WASHINGTON, D.C.**—SUITE 803, 1701 "K" ST., N.W.
CANADIAN DISTRIBUTORS: AVIATION ELECTRIC, LTD., MONTREAL 9 • **EXPORT DIVISION:** BENDIX INTERNATIONAL, 205 E. 42nd ST., NEW YORK 17

"The best laid schemes 'o mice and men

Gang aft a-gley."

BURNS

A year or so ago we advertised our new series AM relays designed for AUTOMATION. The response was overwhelming and for a while we believed that we were really "in business." Yet, because of circumstances beyond our control, the entire project had to be scrapped, at no small loss to both our pride and resources. We feel that we owe our sincere apologies. Perhaps the following explanation is in order.

On October 15th, a fully automated pilot run of 4¾ AM units was completed, the first such production, we believe, ever to be achieved. Full-scale production facilities were immediately set up in an adjoining structure, acquired when the lessee, an abacus manufacturer, sold out last year to an associate of Gen. MacArthur. Production of AM relays in commercial quantities (as advertised) began, directed by digital tape recordings of the last board of director's meeting (with quantitative control, of course, being provided by simple "Start-Stop" switching circuits installed on our Production

Manager's desk).

We are certain this arrangement would have been wholly satisfactory, had not one serious oversight been made. Our (former) production manager failed to adjust the automated timing cycle to coincide with a recent shift from Daylight Saving Time, with the result that AM production became a continuous feedback arrangement of finished relays to initial assembly. Not only did this destroy our costly facilities, but resulted in a finished product which was not a true AM relay, but instead a null-seeking abacus

We sincerely regret our inability to make delivery of our Automation Relays at this time (or any time), but trust you will inform us of any future need for conventional Sigma relays (produced under somewhat more normal circumstances). In case you have hopes of obtaining a n.-s.a. from us, forget it. The entire lot has been dispatched, with our Production Manager and advertising counsel, to a point just inside Outer Mongolia

SIGMA

SIGMA INSTRUMENTS, INC.

62 Pearl Street, So. Braintree, Boston 85, Mass.

25 Ampere Sensitive Contactors	General Purpose Sensitive DC Relays
Missile Relays	High Speed Relays
Sensitive, Low Cost AC Relays	Low Cost Polar Relay
Miniature Sensitive, General Purpose DC Relays	High Speed Electromagnetic Counters
	Null-Seeking Relays

high-speed digital electronic counter is capable of up to 250,000 counts per sec. Modular design of basic plug-in components and the employment of printed circuits make it unusually compact. The basic chassis mounts in only 3½ in. of standard relay rack space and may be mounted on drawer slides or in rugged cabinets. Uses include counting and frequency measurement in laboratory, industrial, military and maintenance applications as a separate instrument or as an integral part of a computer or other device.



FREQUENCY METER is 0.01 percent accurate

RADIO FREQUENCY LABORATORIES, INC., Powerville Road, Boonton 3, N. J. Model 591 heterodyne frequency meter (military type AN/URM-32) is a portable unit of 0.01-percent accuracy using three fundamental frequency ranges and their selected harmonics to measure frequencies between 10 kc and 1,000 mc. The instrument is used to generate a standard frequency voltage between 125 kc and 1,000 mc or to accept a signal from an external source of 10 kc to 1,000 mc and compare it with either a calibrated vfo or a quartz crystal oscillator. The vfo's cover the basic ranges of 125 to 250 kc, 2.5 to 5.0 mc and 65 to 130 mc. The vfo dials permit readings to one part in 50,000. Front panel controls on the unit consist of: (1) a function switch with position for on-off, operate-modulate, and crystal check conditions; (2) a 3-position range switch for selecting the frequency range of the vfo; (3) a single panel zero-beat corrector for standardizing the vfo against the internal crystal oscillators; (4) an age; and (5) a voltage switch for measuring A and B bat-

**FEATURING TEMPERATURE COEFFICIENTS AS LOW AS
10 PARTS PER MILLION PER °C. BETWEEN -55° AND +85°**

**NEW FREED
HIGH FREQUENCY - HIGH "Q"
TOROIDAL INDUCTORS**

**PRODUCTS OF
QUALITY - DEPENDABILITY
RESULTS OF
EXTENSIVE ENGINEERING**

**HIGH FREQUENCY
TOROIDAL INDUCTORS**
featuring very high Q,
temperature stabilization
and low pickup
utilizing the latest ma-
terials and techniques.

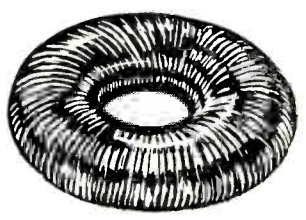

TI-20S

14 stock values
from 0.05 Mhy. to
4.5 Mhy.



TI-23S

15 stock values
from 10 Mhy. to
700 Mhy.

TI-21S

15 stock values
from .01 Mhy. to
1 Mhy.

TI-22S

10 stock values
from 10 Mhy. to
150 Mhy.

	OD	H
TI-20	1"	3/16
TI-21	5/8	3/16
TI-22	7/8	3/8
TI-23	7/8	3/8

Can be supplied hermetically-sealed, encapsulated or in a metal can.

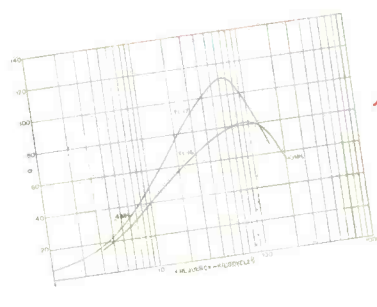
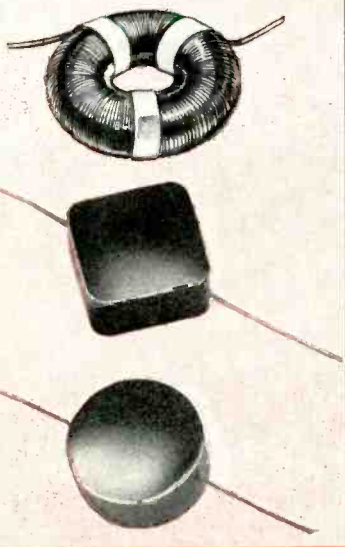

TI-16

20 stock values
from .1 Mhy. to
100 Mhy.

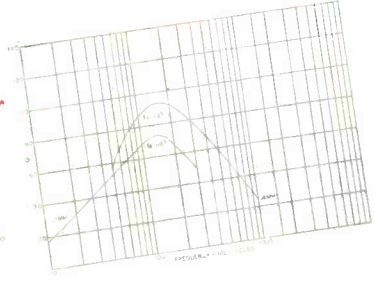

TI-17

18 stock values
from .1 Mhy. to
100 Mhy.

TI-18

18 stock values
from .1 Mhy. to
100 Mhy.

TI-19

13 stock values
from .1 Mhy. to 5
Mhy.

THESE TOROIDS ARE
FEATURING HIGH Q
AND SUBMINIATURE
SIZE. Our unique wind-
ing and impregnation
process insures very
low distributed capac-
ity and consequently
self-resonant frequen-
cies far removed from
the operating range.

NOW AVAILABLE FROM STOCK FOR IMMEDIATE DELIVERY

FREED TRANSFORMER CO., INC.

1722 WEIRFIELD ST., BROOKLYN (Ridgewood) 27, NEW YORK
Phone: EVergreen 6-1300

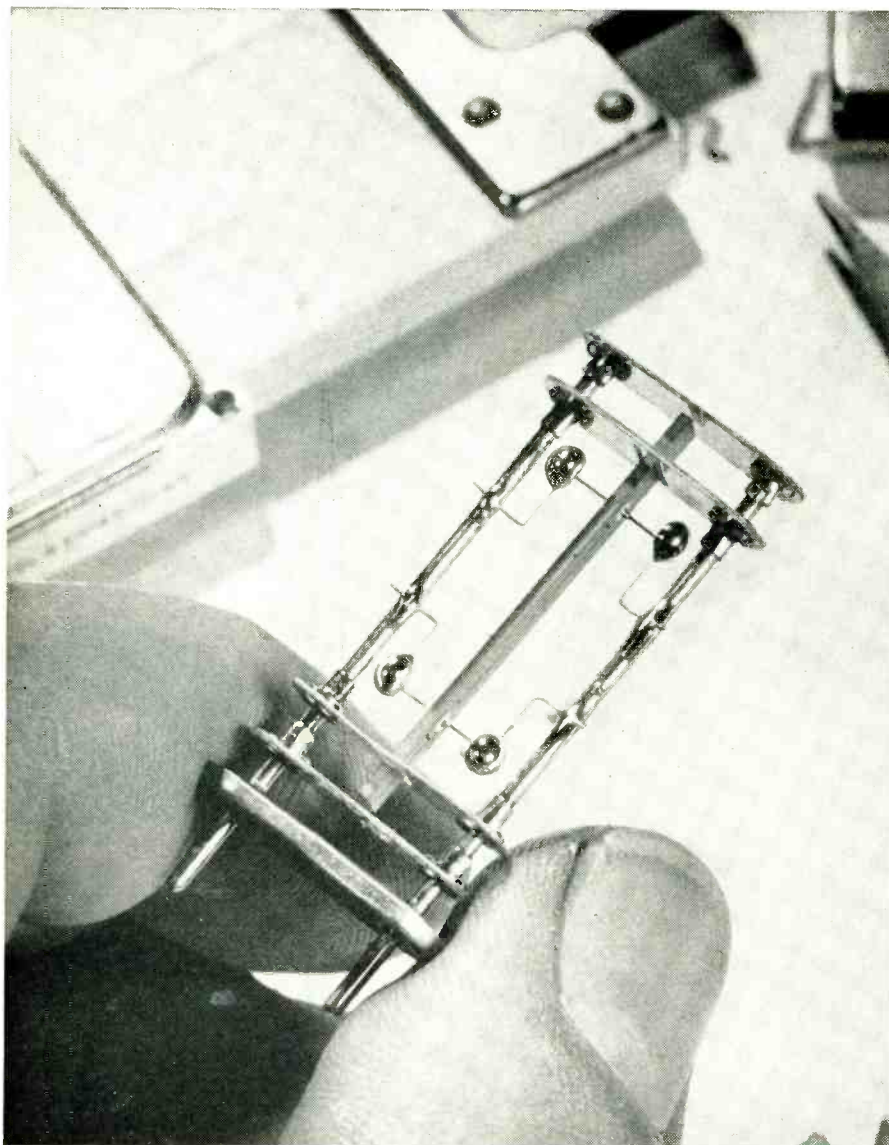

tery voltages with the panel voltmeter.



RESISTANCE DECADE
1 to 0.01 percent accurate

CONSOLIDATED RESISTANCE CO. OF AMERICA, INC., 44 Prospect St., Yonkers, N. Y. Series 1000 Vari-Plug resistance decade consists of extremely accurate (1 to 0.01 percent) resistances encapsulated in epoxy-resin, adjustable by interlocking, shock and vibration-proof plug-in connectors, instead of switches. Design permits the provision of a thermometer well for measurement of temperature rise of individual resistances. This enables accurate determination of minutest resistance changes due to current flow and also the selection of optimum wattage ratings to provide the maximum sensitivity without affecting the accuracy. The decade measures 2 3/4 in. diameter by 2 1/2 in. depth, weighs barely 8 oz. Resistance adjustment can be made in 0.1 or in 1-ohm steps and takes only a few seconds. Nominal power rating of individual resistances is 0.5 w. Versatile application is possible.

SMALL TUBE SOCKET
for use in printed circuits

INDUSTRIAL HARDWARE MFG. CO., INC., 109 Prince St., New York 12, N. Y., has developed a new type miniature tube socket designed for use in printed circuitry. Made of laminated Bakelite, the product snaps and locks into place mechanically when pressure is applied, employing a principle similar to that of a snap fastener. By way

PRACTICE MAKES *Perfect*

Consistent quality is a must characteristic with Bliley BH9A units.

Resonant wire supports, precision alignment, controlled soldering and plating, are the fine points that get special scrutiny, under binocular microscopes, in Bliley production. These minute details can determine performance of an otherwise perfect crystal.

Bliley BH9A units, in the frequency range 16kc to 250kc, are supplied to individual specifications as military types: CR-37, CR-38, CR-42, and CR-50.



BLILEY ELECTRIC COMPANY

UNION STATION BUILDING • ERIE, PENNSYLVANIA

THE GREATEST NAMES IN BRITISH ELECTRONICS USE

BURNDEPT VIDOR
ICTA BUSH ALBA
BUSH PAMPHONIC
RAYMOND B
McMICHAEL
AMPHONIC
EKCO RAYMOND
McMICHAEL R.G.D. (RADIO GRAMOPHONE L
LTD.) REGENTONE BUSH PAMPHONIC INVICTA
BEREC EKCO RAYMOND TRIX ELECTRICAL RO
FERRANTI McMICHAEL VORTEXION H. J. LEAK

TS GRAMPIAN FERRANTI McMICHAEL
VORTEXION H. J. LEAK PARMEKO FER
BUSH ALBA PYE BAIRD EKCO RA
TANNOY FERGUSON PARMEKO M
GRAMOPHONE DEVELOPMENT CO, LT
INVICTA DECCA OF ENGLAND
R ROBERTS FERGUSON FERRA
GRAMOPHONE DEVELOPMENT CO.
C INVICTA DECCA OF ENC
ICAL ROBERTS FERGUSON
GRAMPIAN VIDOR PARM

British equipment manufacturers are making a vital contribution to the development of electronics in all fields of application.

Their products are being exported to every corner of the world, earning a universal reputation for advanced techniques and excellent performance.

The majority of these electronic equipment manufacturers consistently use Mullard tubes. This choice is decided upon because they prefer the greater assurance of efficiency and dependability, and because the vast manufacturing resources of the Mullard organisation guarantee ready availability of Mullard tubes wherever they are needed. Supplies of Mullard tubes for replacement in British equipments are available from the companies mentioned below:—

In the U.S.A. International Electronics Corporation,
Department E11,
81, Spring Street, N.Y. 12, New York,
U.S.A.

In Canada Rogers Majestic Electronics Limited,
Department IC,
11-19 Brentcliffe Road, Toronto 17,
Ontario, Canada.

Mullard

Electronic Tubes— used throughout the world

MULLARD OVERSEAS LTD., CENTURY HOUSE, SHAFTESBURY AVE., LONDON, ENGLAND

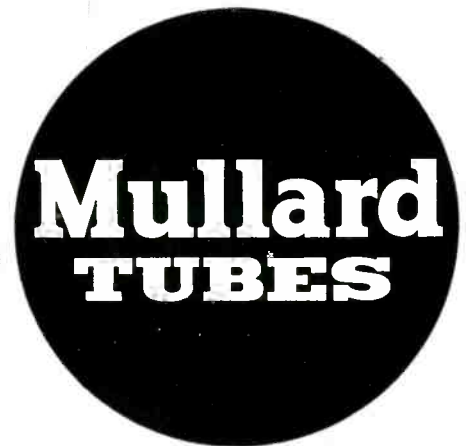

Mullard is the Trade Mark of Mullard Ltd., and is registered in most of the principal countries of the world.

MEV 30

AUTOMATIC PRODUCTION AND QUALITY CONTROL TESTING

with the

CTI Supertester

The CTI Supertester is an automatic, precision instrument for production testing, fault analysis, and preventive maintenance. It checks electronic and electrical products more completely and in a fraction of the time required by present methods.

Providing complete flexibility and rapid interchangeability between products, the Supertester can be programmed for any combination or sequence of the following measurements:

Impedance	A-C Voltage	Leakage
Resistance	D-C Voltage	Continuity



★ REDUCE TEST COSTS

Requiring only an untrained operator, the Supertester frees valuable technical personnel for specialized work. One

Supertester is the equivalent of a series of custom built, single product testers, or a benchful of precision bridges and meters.

★ SPEED PRODUCTION

Complex circuits, gain and frequency measurements, involved relay operations—all are checked at the rate of 180

tests per minute. Hours of manual test procedure have been reduced to minutes. Time is not wasted checking good units.

★ INCREASE PRODUCT QUALITY

Accurately checking every production unit against design values and tolerances, the Supertester does not overlook tests or pass questionable circuits. Original specifications are

tirelessly and rigidly adhered to. Instead of checking only the essential circuit parameters, the Supertester tests equipment completely, quickly, and at far less cost.

Proved in Use!

The Supertester is being used daily by a number of the nation's leading manufacturers. Their testing applications include printed circuits, telemetering units, guided missile circuitry and pre-flight tests, and aircraft electronic equipment.

Whatever the problem, rigid test specifications, high production rates, or reducing test costs, automatic testing is the solution, and the CTI Supertester has proved itself to be the efficient, money saving means to this solution.

COLOR TELEVISION INCORPORATED



SAN CARLOS 1, CALIF.

of this self-locking principle, the socket is kept securely in place in the chassis and cannot be jarred loose by vibration or handling, thus eliminating the need to replace parts that have fallen out prior to the final soldering. The contact tails of the product are rigid and therefore cannot flare outward, which permits easy and quick alignment with the chassis holes.

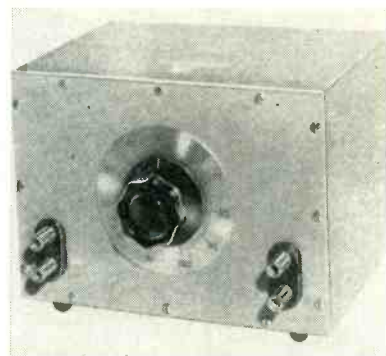

VARIABLE DELAY NETWORK

in ranges of 2 to 2,000 μ sec

ESC CORP., 534 Bergen Blvd., Palisades Park, N. J. Unlike conventional tapped delay lines which must be terminated in a high impedance at the selected tap this new variable delay network provides a variable delay between matched impedances. Available in ranges of 2 μ sec to 2,000 μ sec, the No. 300 series illustrated afford flexibility in obtaining long delays, with time delay proportional to angular rotation of the control shaft.

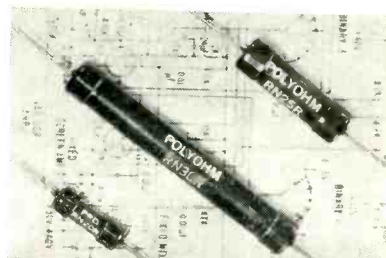

POLYOHM RESISTOR exceeds MIL-R-10509A specs

POLYTECHNIC RESEARCH AND DEVELOPMENT Co., INC., 202 Tillary St., Brooklyn 1, N. Y. The Polyohm 1-percent resistor exceeds all MIL-R-10509A specifications. Taking



HOW ARE YOUR COMMUNICATIONS ?

Do the booklets, pamphlets, and manuals you use really *work* for you? Are these vital publications, that tell the story of your products and your company, as effective, readable, well designed and illustrated as they can be? Today more than ever, your entire operation is judged by each annual report, employee manual, and public relations piece that you produce. Have you examined your communications lately? If you have any doubt as to the impact of your instructional and promotional literature, remember . . .

COMMUNICATION IS OUR BUSINESS

For a good many decades McGraw-Hill has stood for complete coverage in the business literature field. Now the McGraw-Hill TECHNICAL WRITING SERVICE offers a new approach to your publication problems — an *integrated* writing, editing, illustrating, and printing service for the *custom* production of: INSTRUCTION MANUALS, PRODUCT BULLETINS, TRAINING AIDS, INDUSTRIAL RELATIONS LITERATURE, ANNUAL REPORTS, COMPANY HISTORIES, PROCEDURAL GUIDES and other collateral literature. More than 150 editorial and graphic experts are at your disposal, ready to prepare high-quality material to your own or government specifications. Save time, save money . . . and make your communications work! Let *our* staff be your staff for technical and business publications.

McGraw-Hill Book Co. TECHNICAL WRITING SERVICE

Write or phone Technical Writing Service, McGraw-Hill Book Co., Inc.
330 West 42nd Street, New York 36, N. Y. • LOnacre 4-3000

This service is available through ad agencies.

Some Plugs Cause No End of Trouble



But Not PHALO Custom Plugs

... On *PHALO Cord* Assemblies!



You build a fine appliance, you promote it as top quality, the latest in modern appliance conveniences, and just when success seems assured, the plug lets you down!

Or perhaps you design a better production unit, you prove it does the job faster,

cheaper, you find a fine market for the product then the power supply plug throws up a road block!

This *does not need to happen* because PHALO CUSTOM PLUGS are designed to give your product the power it needs when it needs it for as long as it needs it!

Ask For The Complete Phalo Catalog

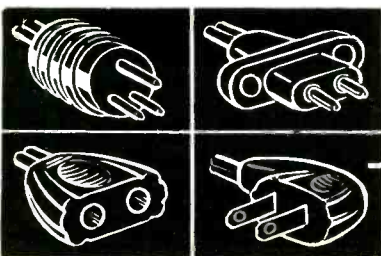

PHALO

PLASTICS CORPORATION

The Custom Cord Set House

CORNER OF COMMERCIAL STREET
WORCESTER, MASS.

Insulated Wires, Cables - Cord Set Assemblies

NEW PRODUCTS

(continued)

full power at ambient temperatures up to 120C, it is ideal for use in aircraft, guided missiles and other applications where high ambient temperatures rule out ordinary 1-percent resistors. Polyohms are also suited for applications where wire-wound resistors are too expensive or bulky or the effect of their inductive and capacitive reactance cannot be tolerated. Unlike usual film resistors, this resistor will remain well within its 1-percent tolerance even under conditions of high humidity. Its temperature coefficient is only -150 ppm per deg C, which is lower than both the R and X characteristics. The resistor is made in $\frac{1}{2}$, 1 and 2-w sizes.



ROTARY SOLENOID for 60-cycle operation

ELECTRONICS, DIVISION OF LEE SPRING Co., 30 Main St., Brooklyn, N. Y. Designed basically for 60-cycle a-c- use, this solenoid can be operated by standard voltages without the use of rectifiers or transformers. The pure rotary movement produced at the shaft simplifies application by eliminating the need for counter-balancing the spiral action of some rotary devices. The torque developed by the solenoid provides all the desirable force characteristics of conventional linear type solenoids, but permits easy installation without levers and linkages. The solenoid is essentially a toroidal coil system wound on a stator and a shaft mounted rotor. When energized, the magnetic field causes the rotor and shaft to turn. The solenoid is unaffected by vibration and shock, and operates perfectly in any mounting position. Eight basic sizes provide a wide

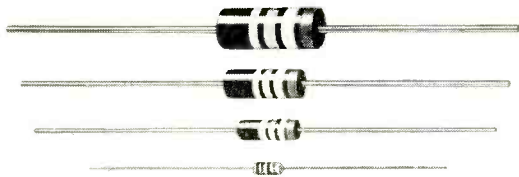

Allen-Bradley molded fixed resistors are available in four sizes—Type TR 1/10 watt; Type EB 1/2 watt; Type GB 1 watt; and Type HB 2 watt. They meet RETMA, JAN-R-11 and MIL-R-11 specifications. Rated at 70C ambient, they require no derating if used on plastic board assemblies. When used according to published ratings, they will not open circuit nor have large erratic resistance changes. In cartons or on reels for automatic assembly.



Allen-Bradley Type J molded variable resistors are made in single, dual, and triple unit construction in total resistance values from 50 ohms to 5 megohms. They are rated at 2 watts at 70C ambient. They are outstanding for their low noise characteristics, initially and after use. Metal parts are made of corrosion-resistant materials. Taps can be supplied at 40, 53, and 68% of effective rotation. A Quality product throughout.

ALLEN-BRADLEY QUALITY COMPONENTS for ELECTRONIC CIRCUITS

Type G molded variable resistors (1/2 inch diam) are ideal for subminiature assemblies. Available with plain bushings or lock-type bushings with plain or screwdriver shafts. Rated at 1/2 watt. Total resistance from 100 ohms to 5 megohms.

Type T molded variable resistor (1 inch diam) are compact 1/2 watt rheostats or potentiometers for hearing aids and other compact applications. Rated at 70C ambient. Total resistance available from 100 ohms to 5 megohms.

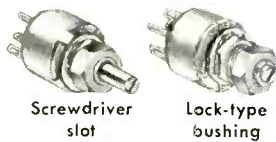

Screwdriver slot Lock-type bushing

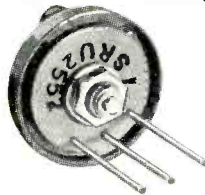

Type T potentiometer

Ceramic dielectric capacitors Type GP—General purpose capacitors for by-pass and filtering at ambient temperatures up to 85C. In RETMA, JAN, and MIL values from 10 mmfd to .022 mfd in d-c voltage ratings of 500, 1000, 2500, and 5000 volts.

Other capacitors are Type TC temperature compensating; Type LB line by-pass; and Type DY deflection yoke capacitors for television scanning frequencies and voltages in standard nominal values from 5 mmf to 470 mmf.

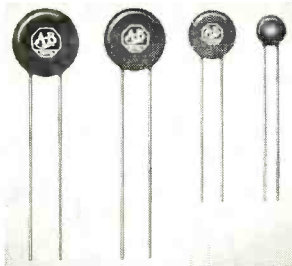

Every step in the manufacture of these capacitors is performed in the Allen-Bradley plant.



Type SO stand-off capacitors



Type FT feed-thru capacitors

Type FT feed-thru and Type SO stand-off discoidal capacitors exhibit no parallel resonance effects normally encountered with tubular capacitors in VHF and UHF frequency ranges.

Type FT feed-thru capacitors are furnished with soldering tabs or with screw thread mountings.

Type SO stand-off capacitors have soldering tabs, screw thread mountings or self-tapping threads.

Both types are available from 5 mmf to 1000 mmf.



Available in various shapes and sizes to fit black and white and color television circuits or for general electronic applications.

A-B ferrite cores are offered in 3 performance classifications—WO-1, WO-2, and WO-3. The WO-2 material has lower losses and higher permeability, making possible appreciable cost savings in designs of television receivers. Write for performance data on Allen-Bradley ferrite cores.

Allen-Bradley radio, electronic, and television components are a QUALITY line of basic units for all types of electronic equipment. Their stable performance characteristics and their conservative ratings make them ideal components for critical applications in military electronic devices. They are widely used in industry, and

by manufacturers of radio and television receivers. There are many additional QUALITY items in the Allen-Bradley line, that are not shown here, which merit your consideration. Allen-Bradley sales engineers are located in principal cities from coast to coast. Call your nearest Allen-Bradley office for technical data, today.

Allen-Bradley Co.
110 W. Greenfield Ave.
Milwaukee 4, Wis.

In Canada
Allen-Bradley Canada, Ltd.
Galt, Ont.



REVERE

Revcothene*

**INSULATED
WIRE**

TOUGH

HEAT-RESISTANT

CHEMICALLY INERT

NON-VOLATILE

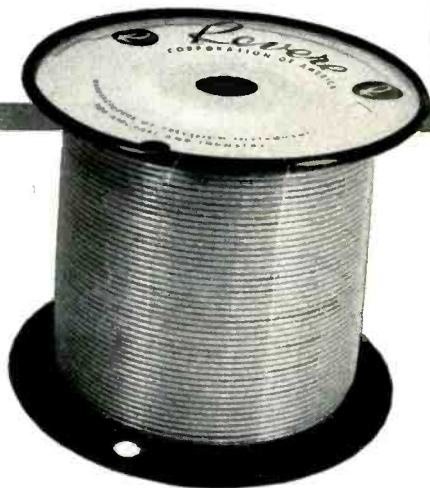

Because of its extreme toughness, high heat resistance, and chemical inertness, Revcothene insulated wire is widely recommended for hermetically sealed equipment . . . for devices operating with small gauge wire at high temperatures . . . and for conditions where corrosion is a problem.

Revcothene is silver-plated copper wire with an extruded coating of monochlorotrifluoroethylene. Even at 150° C. (302° F.) the insulation is inert . . . with no volatile lacquers or plasticizers to ruin contacts. Revcothene withstands abrasion and flexing, and resists such corrosives as ozone, acids, alkalis and petroleum products.

Available in eight standard sizes from 28 to 10 gauge . . . in 15 colors. Flexible strandings, copper or silver braid shielding, heavy wall insulation and jacketing can also be furnished. Multiple-conductor cables are also available.

Revcothene is only one of many insulated wire and thermocouple wire products made to exacting specifications by Revere Corporation of America. Technical design assistance gladly offered. Write today.

TYPICAL SPECIFICATIONS — 22-Gauge Revcothene Wire

Spark Test Voltage	7500
Insulation Resistance	1000 megohms/1000'
Operating Temperatures:	
Flexing Application	—40° C. to 135° C.
Non-Flexing Application	—65° C. to 150° C.
Flammability	Does not support combustion
Operating Voltage	1000 volts
Water Absorption	0.00
Effect of Acids & Alkalis	Generally unaffected
Cold Flow (Compressive Strength)	32,000 PSI
Abrasion Resistance (MIL-T-5438)	Passes 36"-400 grit aluminum oxide with 0.3 pound weight

* Revere's tradename for monochlorotrifluoroethylene



Revere CORPORATION OF AMERICA

WALLINGFORD, CONNECTICUT A subsidiary of Neptune Meter Company

range of forms—offering a variety of torque values from fractional in.-lb to 62.5 in.-lb at maximum stroke on continuous duty models. Stock models give 20, 30 and 45-deg rotation.

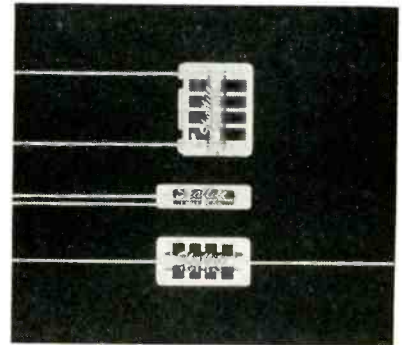
**WIRE-WOUND RESISTORS**
of the wire-lead type

SHALLITE, INC., 10 Mill St., Paterson 1, N. J., has developed a wire-lead precision wire-wound resistor based on transparent encapsulation. The visibility feature, resulting from the transparent encapsulation, assists materially in precluding service failures caused either by bubbles or strains. The new resistors include other outstanding improvements, such as the electric welding of wire to the phosphor bronze leads—all being completely visible through the transparent encapsulation and exceptional compactness. These wire-lead type resistors will exceed the requirements of Government Specification MIL-R-93A. A single-page bulletin now available contains a dimensional diagram, chief features and a table of specifications.

**STROBO-SYNC**
for vibration analysis

WINKLER LABORATORIES, 5225 North 20th St., Phoenix, Arizona. Model

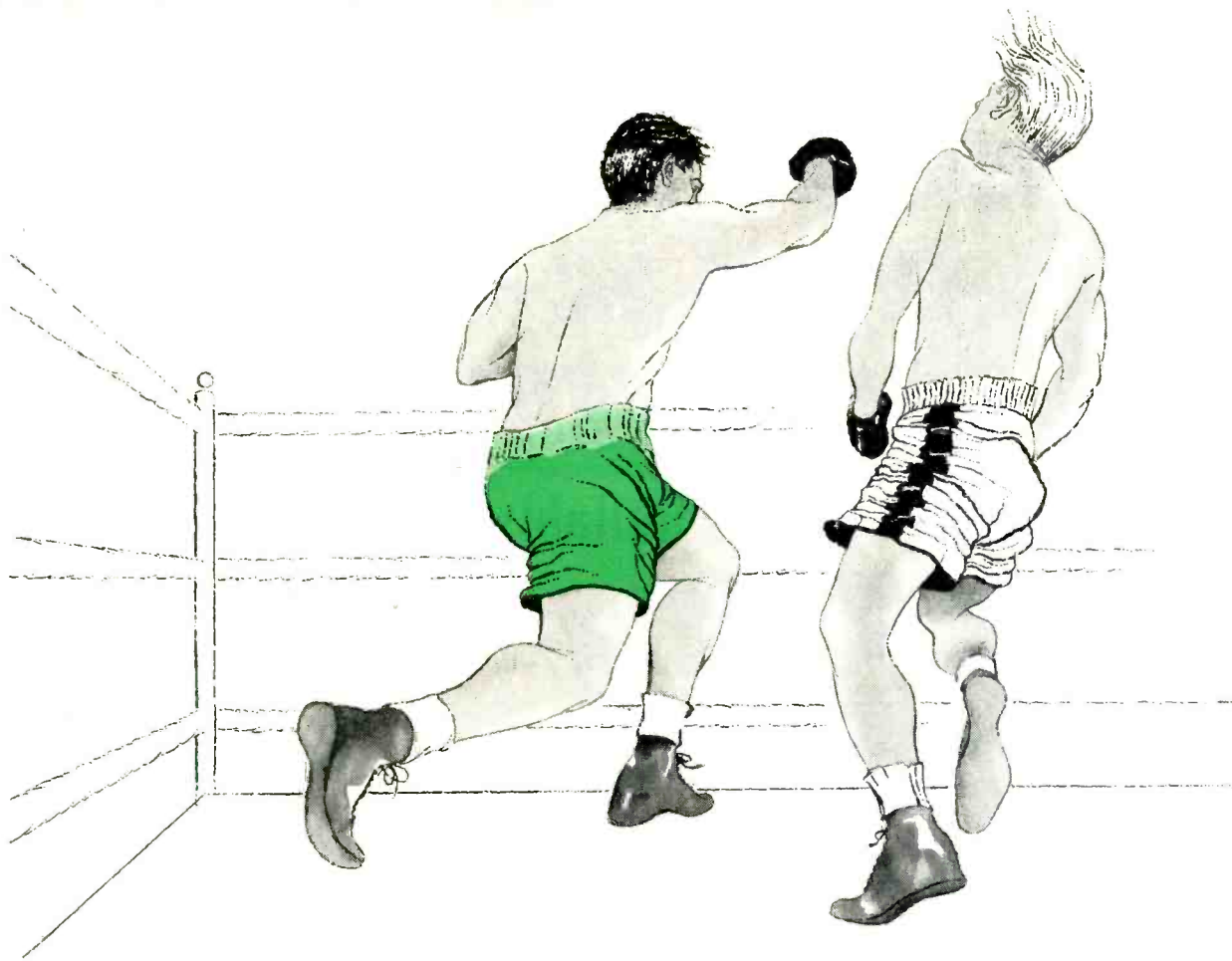

*Constantin K.O.'s your production problems
with another modern, complete plant.*



Plant No. 1
Route 46,
Lodi, New Jersey

Now Plant No. 2

187 Sargeant Avenue Clifton, New Jersey

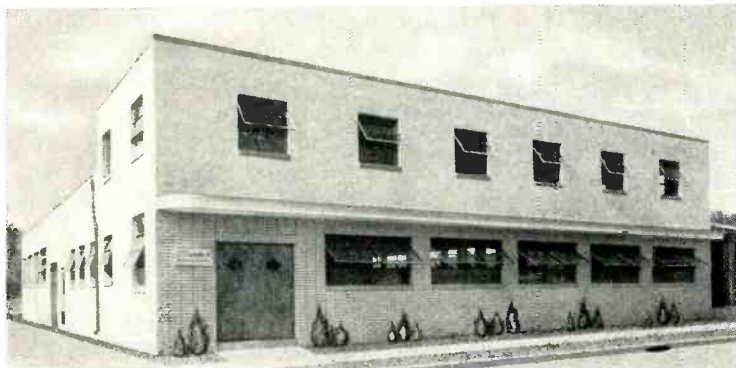

In order to meet the increased demands of the Electronic Industry, L. L. Constantin continues its expansion program by the opening of another, modern plant at 187 Sargeant Avenue, Clifton, New Jersey. Equipped with complete facilities for **VOLUME PRODUCTION**, the Clifton Plant will manufacture the full line of Constantin's high-quality, glass-to-metal vacuum seals.

L. L. Constantin & Co.
MANUFACTURING ENGINEERS

TRANSISTOR MOUNTS • SINGLE TERMINALS • COMPRESSION HEADERS • END SEALS • CRYSTAL BASES • AN CONNECTORS • MINIATURIZATION

MEASURE NOISE AND FIELD INTENSITY FROM 150 KC TO 1000 MC— WITH ONE METER!

Quickly • Accurately • Reliably

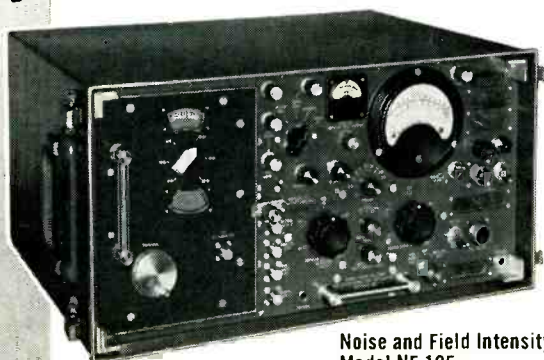

Noise and Field Intensity Meter
Model NF-105
(Commercial Equivalent of AN/URM-7)



TA/NF-105:
150 KC-20MC



T1/NF-105:
20-200MC



T2/NF-105:
200-400MC



T3/NF-105:
400-1000MC

Empire Devices Noise and Field Intensity Meter Model NF-105 permits measurements of RF interference and field intensity over the entire frequency range from 150 kilocycles to 1000 megacycles. It is merely necessary to select one of four individual plug-in tuning units, depending on the frequency range desired. Tuning units are readily interchangeable... can be used with all Empire Devices Noise and Field Intensity Meters Model NF-105 now in the field.

Each of the four separate tuning units employs at least one RF amplifier stage with tuned input. Calibration for noise measurements is easily accomplished by means of the built-in impulse noise calibrator. With this instrument costly repetition of components common to all frequency ranges is eliminated because only the tuners need be changed. The same components... indicating circuits, calibrators, RF attenuators, detectors and audio amplifier, and power supplies... are used at all times.

Noise and Field Intensity Meter Model NF-105 is accurate and versatile, it may be used for measuring field intensity, RF interference, or as an ultra-sensitive VTVM. A complete line of accessories is available.

Additional information and literature upon request

NEW YORK—Digby 9-1240 • SYRACUSE—Syracuse 2-6253 • PHILADELPHIA—Sherwood 7-9080 • BOSTON—Waltham 5-1955 • WASHINGTON, D. C.—DEcaur 2-8000 • ATLANTA—EXchange 7801 • DETROIT—Broadway 3-2900 • CLEVELAND—EVERgreen 2-4114 • DAYTON—Fulton 8794 • CHICAGO—Columbus 1-1566 • DENVER—MAin 3-0343 • FORT WORTH—WEHster 8811 • ALBUQUERQUE—Albuquerque 5-9632 • LOS ANGELES—REpublic 2-8103 • PALO ALTO—DAvenport 3-4455 • CANADA: MONTREAL—UNiversity 6-5149 • TORONTO—WAlnut 4-1226 • HALifax 4-6487
EXPORT: NEW YORK—Murray Hill 2-3760

**EMPIRE DEVICES
PRODUCTS CORPORATION**

38-15 BELL BOULEVARD • BAYSIDE 61 • NEW YORK
manufacturers of

FIELD INTENSITY METERS • DISTORTION ANALYZERS • IMPULSE GENERATORS • COAXIAL ATTENUATORS • CRYSTAL MIXERS

NEW PRODUCTS

(continued)

201A Strobe-Sync automatically synchronizes commercial and existing stroboscopic light sources with electrically driven h-f shake machines so that objects may be observed in apparent slow motion. The visual frequency is adjustable from zero to over 2 cps and once adjusted remains constant over the entire range of shake frequencies from 20 to 2,000 cps. No adjustment of amplitude is required over a 40-db range. No other adjustments exist or are required. It eliminates the need for an operator normally required to constantly adjust the stroboscopic light frequency. A single-page bulletin giving specifications and price is available.

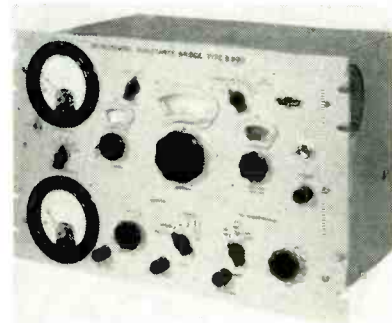

HAY BRIDGE for reading inductance and Q

FURZEHILL LABORATORIES LTD., 57 Clarendon Road, Watford, Herts., England. Type B.800 incremental inductance bridge gives direct reading of inductance and Q of iron-cored inductors with or without d-c flowing. Both these parameters are dependent on the value of a-c excitation and accurate metering facilities are included to measure the a-c voltage across the choke under test. A particular feature of the bridge is that it is designed for operation of a range from 25 to 3,000 cps. This has been done to cope with the increasing demand for measurements at frequencies other than 50 cps, such as the checking of inductors for polyphase rectifiers, radar systems and aircraft equipment. Balance is indicated on a logarithmic meter having 5 ranges of sensitivity, fed from the bridge output through a selective amplifier which eliminates waveform errors. This results in a sharp null so that precise and repeatable readings are

Another example of EDO's Ever-Increasing Role in the
Field of MARINE ELECTRONICS

WITH THE NEW
EDO *Direct-Reading* **LORAN**

Now, Edo, a recognized leader in marine electronic development, announces a new Loran at a practical price. Built to the highest electronic standards, the Edo Loran gives quick, directly-read time difference readings for accurate plots in a matter of seconds. No calculations, no computations, no tables, no special training needed to operate.

Edo has achieved a practical low price for its new Loran with no compromise in quality by applying the most advanced electronics circuitry. For instance there are less than half the number of tubes in the Edo Loran (only 28) than in any other currently available equipment. This at no sacrifice in accuracy and with the advantage of lower power requirements, easier maintenance, and greater dependability.

Features of the



Model 262 Loran

- ★ Only 28 tubes including cathode-ray tube and rectifiers.
- ★ Single, compact, light-weight, self-contained unit.
- ★ Low power consumption, 200 watts, 117 volts @ 60 cycles.
- ★ The unit can be mounted on a table, suspended from overhead or bulk-head.
- ★ Large direct reading dials especially illuminated for night use. Recessed CRT requires no hood.
- ★ Delay is not stored and cannot drift.

**SEND FOR THE NEW BROCHURE ON
THE EDO MODEL 262 LORAN.**

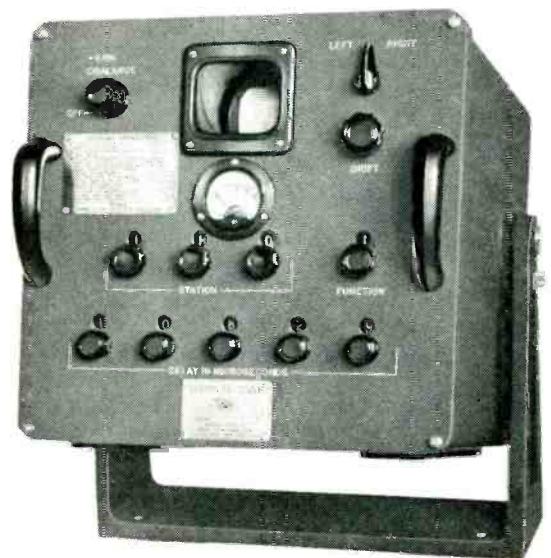

Edo

CORPORATION

College Point, L.I., N. Y.

SINCE
1925

easily obtained. Leaflet B.1 gives circuit description and specifications.

POWER CONNECTORS meet new military specs

AUTOMATIC AND PRECISION MFG. Co., 252 Hawthorne Ave., Yonkers, N. Y., has announced miniature armored connectors that meet the requirements of the recently amended military specification MIL-C-3767. Plugs are rated for 125 v 15 amperes up to 250 v 10 amperes, and will accommodate cables from 0.125 in. to 0.450 in. in diameter. Insert material is glass-filled melamine (under MIL-P-14). It withstands high impact and retains dielectric properties even after long exposure to moisture while under polarized voltages. Grounding blade on one type (the UP121M) is removable, making the connector serviceable where grounding receptacles have not been provided.



SENSITIVE RELAY of the miniature type

MAGNADYNE Co., 84 S. Water St., Port Chester, N. Y. Model No. 10 miniature sensitive relay is suited for both commercial and military applications where either single or double-pole miniature sensitive relays meeting high standard shock, temperature, minimum space, and vibration requirements are needed. It has a 10-g standard vibration immunity and a 100-g nonoperating shock resistance. Units are hermetically sealed and conform to MIL-R-5757 specifications. Con-

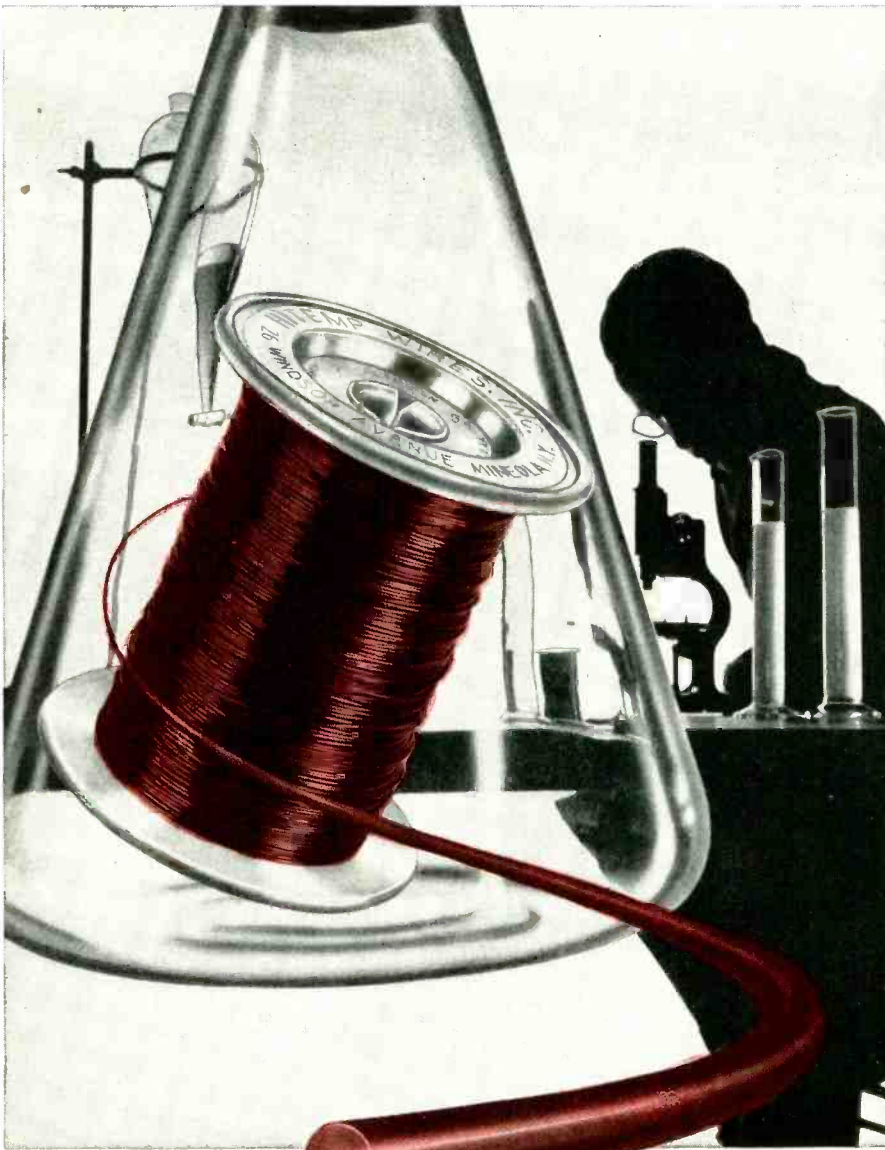

for Teflon* on wire

From advanced know-how and industrial chemistry . . . came "Teflon." Through unique applications of "Teflon" on wire and cable . . . Hitemp Wires, Inc. has opened new horizons for the electronic and electrical industries.

With "Teflon" insulated wire, tubing, multi-conductor cables, lacing cord, tape and sewing thread, miniaturized electronic and electrical components are now possible . . . with the amazing working temperature range of $-70^{\circ}\text{C}.$ to $+260^{\circ}\text{C}.$

"Teflon" insulated products offer this unexcelled combination of properties: low loss factor, low dielectric constant, high volume resistivity, nonflammable, low coefficient of friction, unaffected by moisture, tough . . . yet flexible, and completely inert to all known commercial solvents.

For better products . . . for lower production costs, call the leading specialist in high temperature insulations . . . your nearest Hitemp Wire, Inc. sales engineer.

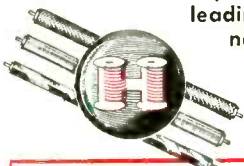

HITEMP WIRES, INC.

26 WINDSOR AVE., MINEOLA, NEW YORK

NATIONAL REPRESENTATIVES

FLORIDA Larry Johnson 117 N. W. 107th St. Miami, Florida	UPPER NEW YORK STATE Philip L. Kirsch 223 Winemere Road Rochester, N. Y.	ARIZ. & N. MEX. Russell Engineering 2145 Westwood Blvd. Los Angeles 25, Cal.	TEXAS General Power Equipment 4515 Pringle Street Dallas, Texas	CANADA, ALA., GA., LA., MISS., PA., VA., W. VA. Alcon Accessory Co. 181 Orasco Drive Birmingham, N. Y.	MO. & DEL. Sol W. Goodman 22 W. Bluff St. Baltimore, Md.	CALIF. & WASH. Standard Wire & Cable 3440 Overland Ave. Los Angeles, Calif. 710 Post St., Rm. 915 San Francisco, Cal.	KENTUCKY & OHIO Galagher Company 15 Racine Avenue Cincinnati, Ohio	WASH. D.C.—GOV. John W. Houston Jr. 748 Washington Bldg. Washington 5, D. C.
INDIANA Richard C. Warner Box 338 South Whitley, Ind.	ARK. IOWA, ILL., MO., N.E. White Supply Co. 4263 Durbin Ave. St. Louis, Mo.	MAINE, N. H., MASS., N. J., N. Y., R. I. Ward F. Humphrey 33 Earl Plain St. Cohasset, Mass.	MICHIGAN James B. Morrow 85 Louise Ave. Michigan Park, Mich.	NEW YORK & NEW JERSEY Pat Distributors 240 Old Country Rd. Richville, N. Y.	ILL. & WIS. Wesley L. Wilson 2750 West North Ave. Chicago, Ill.	CONNECTICUT Richard Whitstead, Jr. Guilford, Conn.	M. C., S. C. & TENN. Cohen & Larson 123 Brewer Court Charleston, W. C.	SPRINGFIELD Baltimore Trading Co. 1505 Race St. Phila. 2, Pa.

*DuPont's Trade Name for POLYTETRAFLUOROETHYLENE

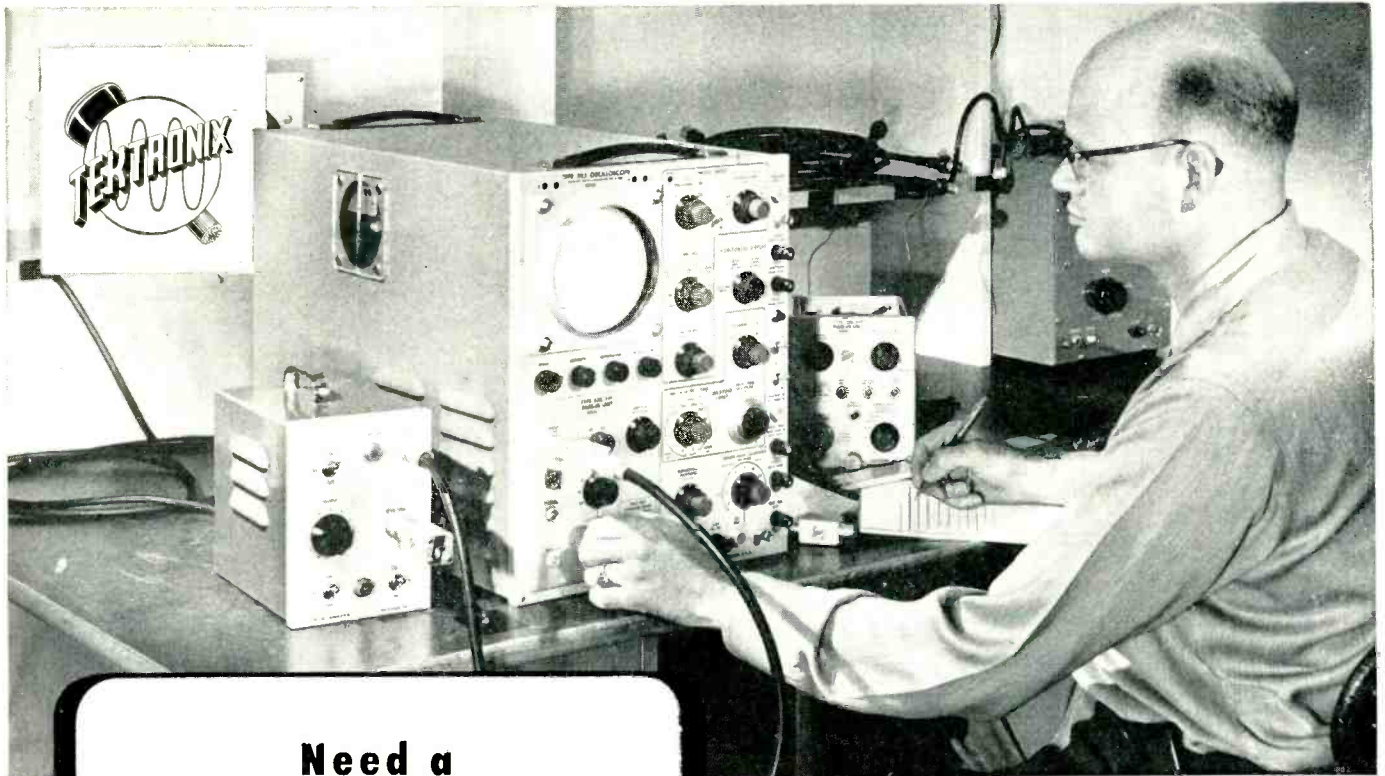

Need a VERSATILE OSCILLOSCOPE?

Most of the oscilloscope applications you are likely to encounter can now be handled by a single instrument. Tektronix Oscilloscopes of the Type 540 and Type 530 Series have the wide sweep range, triggering flexibility, bright display, and accurate calibration essential to broad application coverage. With one of the wide-band vertical preamplifiers plugged in, the versatility of these oscilloscopes leaves few applications out of range.

Usefulness of these oscilloscopes is further increased by the availability of extra plug-in units for several specialized applications at small additional cost. Conversion is a simple mechanical operation that takes only a few seconds. For instance, if the next job requires sensitivity to a fraction of a millivolt, just remove the plug-in unit previously in use and insert the Type 53/54E unit. You change from one set of requirements to another without handling heavy, bulky equipment.

For complete specifications on these or other Tektronix oscilloscopes, please call or write your Tektronix Field Engineer or Representative, or write us at address below.

Tektronix, Inc.

P. O. BOX 831, PORTLAND 7, OREGON
CYpress 2-2611 • Cable: TEKTRONIX

DC TO 30 MC OSCILLOSCOPES

Type 541 Oscilloscope, in combination with the Type 53/54K Plug-In Unit, has a dc-to-30 mc vertical passband, risetime of 12 millimicroseconds, and sensitivity to 0.05 v/cm; 600,000,000 to 1 sweep range is continuously variable from 0.02 μ sec/cm to 12 sec/cm, with 24 calibrated steps from 0.1 μ sec/cm to 5 sec/div and accurate 5x magnifier. 10-kv accelerating potential on Tektronix precision C-R tube. **Type 541—\$1145** plus price of desired plug-in units.

Type 545 Oscilloscope has same specifications plus accurate delayed-sweep circuitry. Sweep delay is continuously variable from 1 μ sec to 0.1 sec; 12 calibrated ranges are accurate within 2%. Incremental accuracy is within 0.2% of full scale. Delayed sweep can be triggered by observed signal for jitter-free display. **Type 545—\$1450** plus price of desired plug-in units.

DC TO 10 MC OSCILLOSCOPES

Type 531 Oscilloscope has dc-to-10 mc passband, 0.035- μ sec risetime with wide-band plug-in units. Sweeps and accelerating potential same as Type 541. **Type 531—\$995** plus price of desired plug-in units.

Type 535 Oscilloscope has same specifications as Type 531 plus delayed sweeps as described for Type 545.

Type 535 — \$1300 plus price of desired plug-in units.

DC TO 5 MC OSCILLOSCOPE

Type 532 Oscilloscope has dc-to-5 mc passband, 0.07- μ sec risetime. Sweep range is 0.2 μ sec/cm to 12 sec/cm continuously variable, with 21 calibrated steps from 1 μ sec/cm to 5 sec/cm and accurate 5x magnifier. 4-kv accelerating potential on Tektronix precision C-R tube.

Type 532 — \$825 plus price of desired plug-in units.

PLUG-IN PREAMPLIFIERS

for Type 540-Series and Type 530-Series Oscilloscopes

Type 53A Wide-Band DC unit.....	\$ 85
Type 53B Wide-Band High-Gain Unit.....	125
Type 53C Dual-Trace DC Unit.....	275
Type 53/54D Differential High-Gain DC Unit.....	145
Type 53/54E Low-Level Differential AC Unit.....	165
Type 53G Differential Wide-Band DC Unit.....	175
Type 53/54K Fast-Rise DC Unit.....	125

All prices f.o.b. Portland (Beaverton), Oregon

AUTOMATIC ELECTRONIC DECADE SCALER and TIMER for optimum speed and accuracy

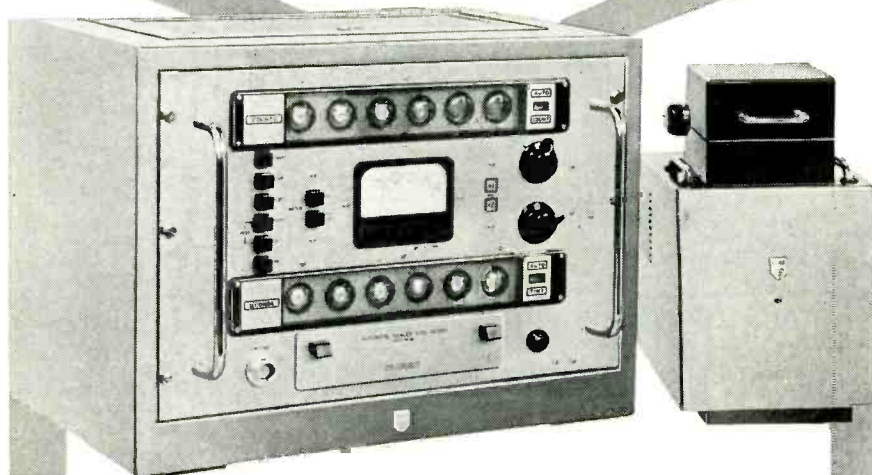

The simplicity and accuracy of Dekatron counting and timing circuits make the Ekco Model N-530A Automatic Scaler the most outstanding and most versatile instrument of its kind. This scaler will time a pre-determined count, count for a pre-determined time, or can be manually operated.

FEATURES:

- Preset/elapsed time interval—100-100,000 seconds in 10ths
- Preset/elapsed count interval—100-1,000,000 counts
- Maximum counting rate—60,000 counts/second
- Maximum stopping time—2 milliseconds
- Six electronic decades
- Dekatron direct-reading counting and timing tubes
- Pulse height discriminator permits use with G-M, scintillation, flow or proportional counters—variable 5-50 volt acceptance level

SPECIFICATIONS:

- Input sensitivity—negative 0.1 volt and positive 5 volts
- Input resolution time—5 microseconds, low coincidence loss
- Power Requirements—110-250v, 50/60 cycles, 130 watts
- Dual-range Power Supply—250-1000 and 500-2000 volts
Stability — $\pm 0.5\%$ for variations up to $\pm 10\%$
Ripple—less than 5 mv. rms peak

Write TODAY to our American representative for technical data on the complete line of EKCO equipment.

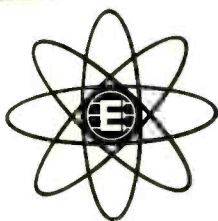

EKCO

ELECTRONICS, LTD. Southend-on-Sea, Essex, England
U. S. Sales and Service
AMERICAN TRADAIR CORP. • Long Island City 6, New York

tacts are silver, rated 2 amperes, 28 v d-c and 115 v a-c. Life expectancy at rated resistive loads is 100,000 operations. Operating power is 40 mw for dpdt and 20 mw for spdt. The model No. 10 contains a high-efficiency double coil magnetic circuit with a resistance up to 12,000 ohms, with a maximum dissipation of 1 w. Size is approximately 1 in. by 1 in. square by 2 in. in overall length.

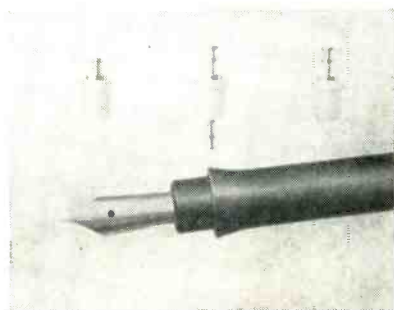

PUSH-IN TERMINALS mount by a press fit

CAMBRIDGE THERMIONIC CORP., 445 Concord Ave., Cambridge 38, Mass., announces a new series of push-in insulated terminals, designated as X-2182, that mount by a press fit, using Teflon both as a holding material and as an insulator. The new terminals permit a press-fit into mounting panels of $\frac{1}{16}$ in. to $\frac{1}{8}$ in. in thickness, with secure seating that keeps terminals shake proof and firmly attached. These terminals feature high terminal pull strength in any direction. Complete specifications, information and prices are available from the manufacturer.



WIDE-BAND AMPLIFIER is feedback stabilized

ELECTRICAL AND PHYSICAL INSTRUMENT CORP., 42-19 27th St., Long

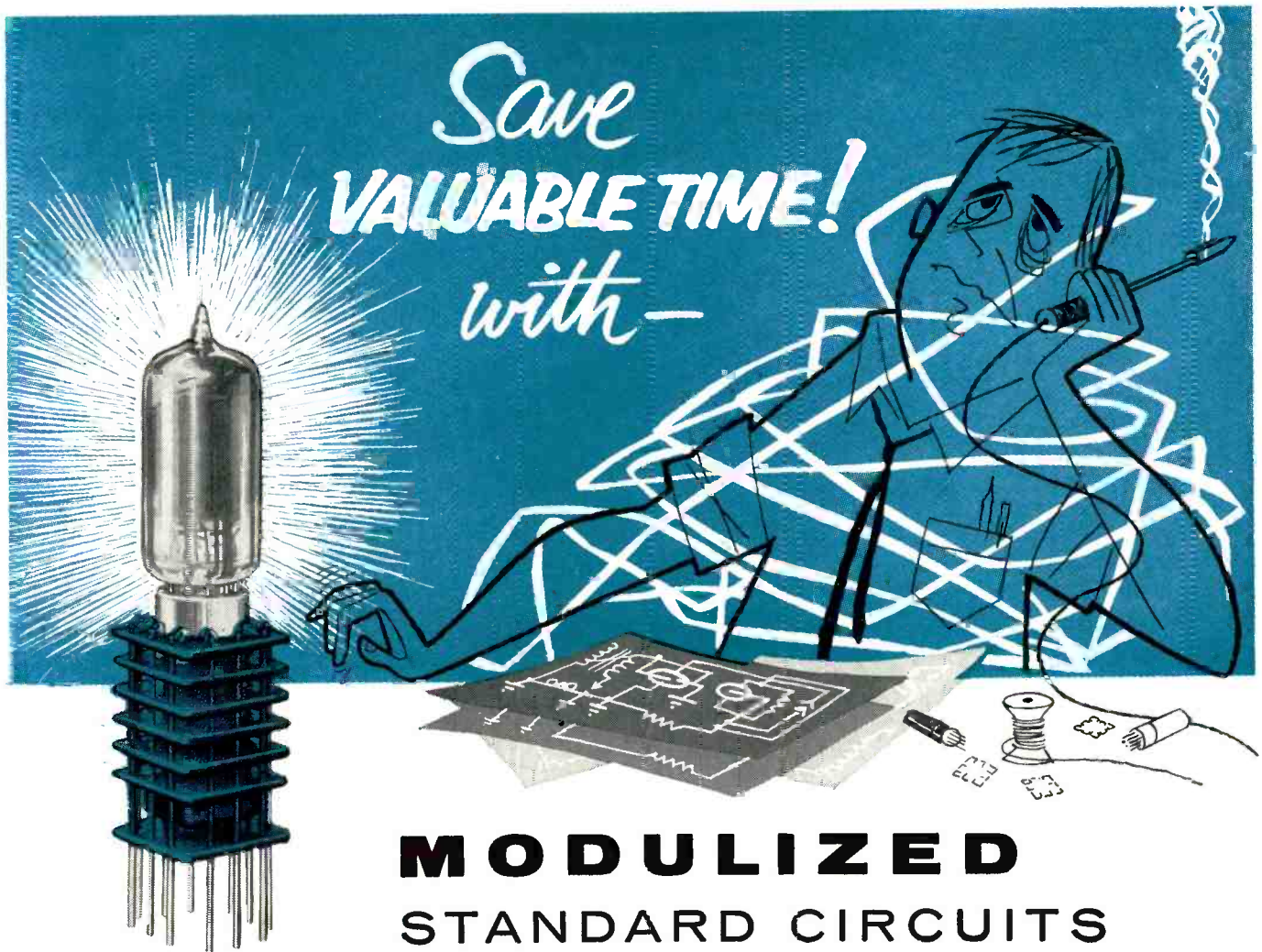

MODULIZED STANDARD CIRCUITS

Why fuss and fume over basic circuit details? That's the technician's, not the engineer's job, when dealing with standard circuitry. There's more important, more profitable, more rewarding work to do in creative design.

Which accounts for Aerovox Modulated Standard Circuits. Block diagrams are reduced to functional units that plug or otherwise connect into your designs and assemblies. Modules are complete, wired, tested sub-assemblies to save you untold time, effort, expense. They provide that firm foundation on which you can build up your creative talents. And especially vital in facing today's engineering shortage.

Seven standard circuits are now available in handy module form. Others to follow for both standard and special circuit requirements. These modules are but part of the Aerovox Automation Program. New type capacitors, resistors, sockets and other components, in conjunction with advanced printed wiring and ingenious automatic assembly techniques, are available to those interested in radio-electronic Automation.

WRITE FOR BROCHURE! Engineering details available to anyone writing on business stationery. Let our module specialists show you how to apply these basic circuit assemblies in gaining released time for your creative efforts.



AEROVOX CORPORATION

ARLINGTON, VIRGINIA

In Canada: AEROVOX CANADA LTD., Hamilton, Ont.

Export: Ad. Auriema, Inc., 89 Broad St., New York, N. Y. • Cable: Auriema, N. Y.

AEROVOX CORPORATION, NEW BEDFORD, MASS. • HI-Q DIVISION, OLEAN, N. Y. • ACME ELECTRONICS, INC., MONROVIA, CALIF. • CINEMA ENGINEERING CO., BURBANK, CALIF. • HENRY L. CROWLEY & CO., WEST ORANGE, N. J.

WHY WIRE when
you have this convincing proof of
the many benefits of "PHOTOCIRCUITS" . . .

OVER

4,000

**DIFFERENT
APPLICATIONS**

of Printed Circuits and Associated Assemblies
HAVE BEEN PRODUCED TO DATE by

Photocircuits
CORPORATION

These are YOUR BENEFITS:

- SHORTER ASSEMBLY LINES
- IMPROVED RELIABILITY
- REDUCED ASSEMBLY TIME
- MINIATURIZATION
- CIRCUIT REPRODUCIBILITY
- LOWER INSPECTION COSTS
- PRODUCT IMPROVEMENT

**WE ARE NOW BUILDING A NEW PLANT TO
MORE THAN DOUBLE OUR PRESENT FACILITIES!**

Consult our Engineering Department or any of our Sales-Engineering Field Offices.

Photocircuits
CORPORATION

DEPT. E11, GLEN COVE, NEW YORK

TELEPHONE: GLEN COVE 4-4000 • FLUSHING 3-5050



® Trade Mark

**EXCLUSIVELY PRINTED CIRCUITS
and Associated Sub-Assemblies
ADVANCED DESIGN & TECHNIQUE
MAXIMUM EXPERIENCE**

BOSTON: 25 Huntington Ave. • Commonwealth 6-7705
BIRMINGHAM, ALA.: 404 Dexter Ave. • Phone 2-1349
CHARLOTTE, N. C.: 222 Providence Rd. • Franklin 5-8958
CHICAGO: 3347 W. Irving Park Rd. • Keystone 9-7355
DALLAS: 2011 Cedar Springs • Sterling 3335
DAYTON, O.: 25 So. Main Bldg. • Fulton 6377
LOS ANGELES: 7407 Melrose Ave. • Webster 3-7274
PHILADELPHIA: 1531 Spruce St. • Kingsley 5-1205
ROCHESTER, N. Y.: 3 Jupiter St. • Culver 7635
SPOKANE: W. 112 Montgomery • Glenwood 2307

Island City 1, N. Y. Model 720 is a feedback stabilized wide-band amplifier designed for use in amplifying to a high output level the fast pulses encountered in nuclear research, tv, transient studies and other applications where a wide bandwidth and a faithful pulse reproduction are required. The bandwidth is from below 2,000 cycles to 10 mc. Gain is continuously variable by coarse and fine attenuators from 60 db to 20 db. The output stages deliver up to 50 v pulses into a 1,500 ohm load or 10 v into a 200 ohm load. An input polarity switch allows either positive or negative input pulses to appear as positive output pulses. A switch selects either high or low input impedance.

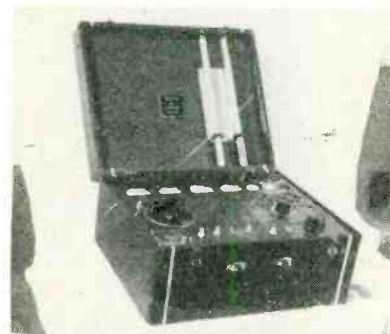

TUBE ANALYZER tests thyratrons, phanotrons

ELECTRIC MFG. Co., 7842 39th Ave., Kenosha, Wisc. Model No. JB-16A tube analyzer tests tubes under actual circuit operating potentials. The thyatron actually functions in an operating circuit with meters indicating operating points, permitting quick comparison with tube manufacturers' specifications and curves, and automatic indication of critical grid volts. All common industrial tubes are accommodated, from 1 ampere upwards. Average arc-drop voltmeter provides direct indication. Input of the analyzer is 105 to 130 v a-c, 1 phase, 60 cycle. A bulletin on the unit is available.

TRANSISTOR features low cost

GENERAL ELECTRIC Co., Syracuse, N. Y., has placed on the market a

IN COUNTING THE COUNTLESS...

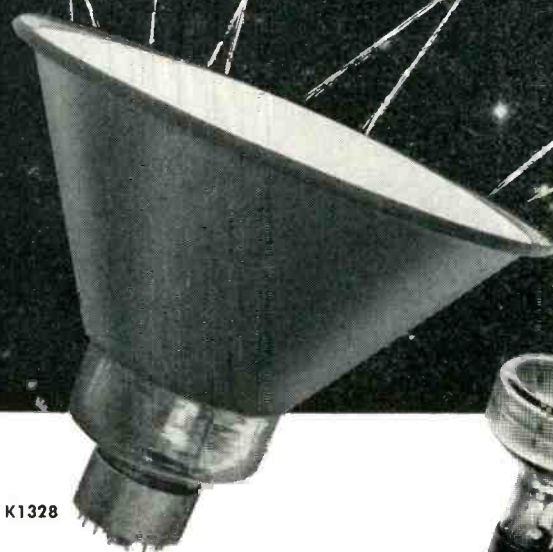

TYPE K1328



TYPE 6364



TYPE 6363

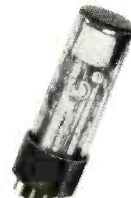

TYPE 6467



TYPE 6292



TYPE 6365

Count on DuMont multiplier phototubes — whether you're counting stars, scintillations or holes in punched cards.

DuMont multiplier phototubes have become a *standard for comparison*. Their superior long-term stability, their high cathode sensitivity, their excellent signal to noise ratio and their very high amplification are all well known by critical users of multiplier phototubes.

From 3/4" size used in oil-well exploration and medical research to the 16" giants used for large area counting in astronomy and critical radiation studies, DuMont multiplier phototubes share the same fine characteristics.

If you aren't familiar with DuMont multiplier phototubes and want the complete story, just write on your company letterhead to:

DU MONT

Technical Sales Dept. ALLEN B. DU MONT LABORATORIES, Inc. 760 Bloomfield Avenue, Clifton, N. J.



MISSILE SYSTEMS

PHYSICISTS AND ENGINEERS

Research and development in the technology of guided missiles is not confined to any one field of physics. Broad interests and exceptional abilities are required by the participants. Typical areas at Lockheed Missile Systems Division include:

- Applied mathematics such as the numerical solution of physical problems on complex computers
- Analytical systems analysis of guidance and control problems
- Ballistics and the integration of ballistic type missiles with vertical guidance
- RF propagation, microwave and antenna research and development
- Integration of ground and flight test data to evaluate dynamic performance
- Stress and structures
- Instrumentation and telemetering
- Advanced electronics and radar systems

Continuing developments are creating new positions for those capable of significant contributions to the technology of guided missiles.

Lockheed

**MISSILE
SYSTEMS
DIVISION**

research and engineering staff

LOCKHEED AIRCRAFT CORPORATION

VAN NUYS • CALIFORNIA

new stable, inexpensive transistor. The 2N107 is a *pn*p audio transistor produced by the company's fused junction process. It has an all-metal case and is hermetically sealed for the maximum in reliability. Hermetic sealing is accomplished by the use of glass-to-metal seals and resistance-welded seams. The 2N107 in a typical common emitter circuit has a power gain of 38 db. Maximum frequency cutoff is 2.5 mc with the design center at 1.0 mc. Alpha design center is 0.95. Maximum collector voltage is -12 v and the maximum junction temperature is specified at 60 C. The transistor is capable of dissipating 50 mw in 25 C free air.



TIME DELAY RELAY is highly reliable

E.V. NAYBOR LABORATORIES, 30 Manorhaven Blvd., Port Washington, N. Y. Type TD6H time delay relay uses an air dashpot for the delay function which affords good stability under various environmental conditions. Resistance to high shock and to vibration at all frequencies is inherent in the design. Contacts provide direct control of equipment in most cases, thus eliminating the need for an auxiliary relay. The snap-action switch is operated by an efficient magnetic actuator. Relay operation is d-c at standard nominal voltages. Coil resistance values to 12,000 ohms can be supplied and relays for a-c operation are obtainable on special order. Contact arrangement is single or dpdt and contacts are rated at 5 amperes for 115 v a-c or 26.5 v d-c. Temperature range is

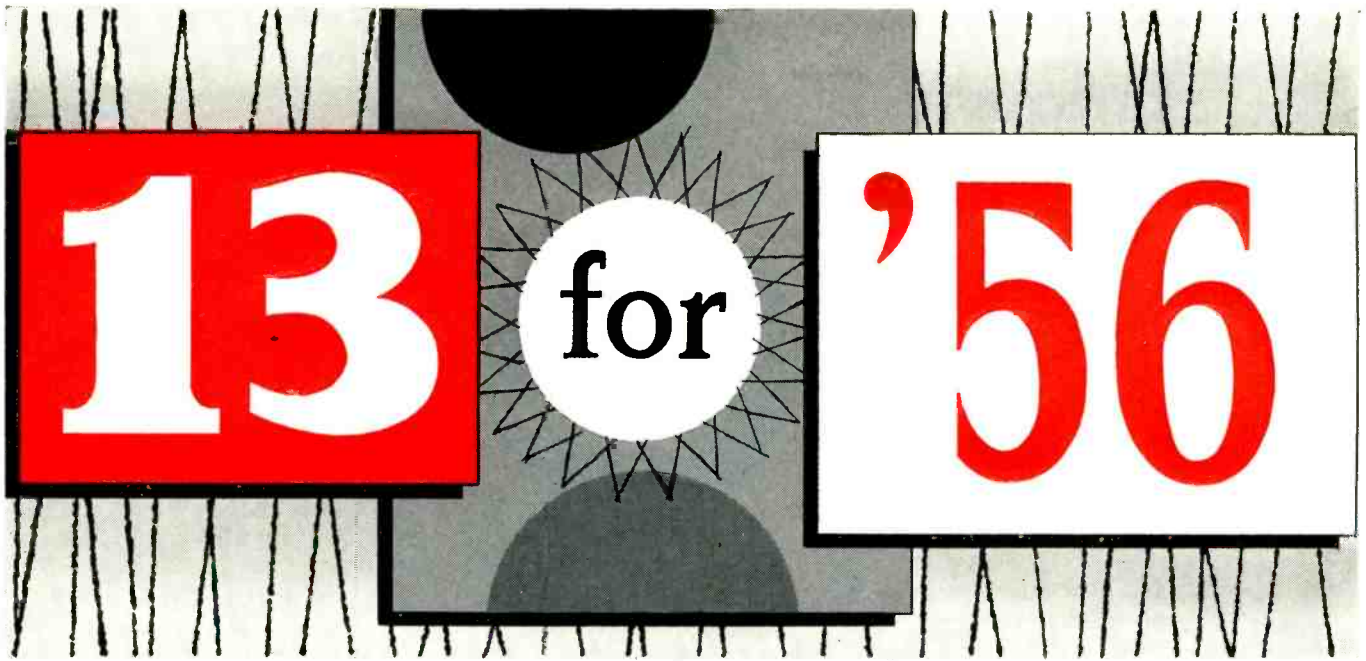

... what we mean is a promotion package of
12 REGULAR ISSUES OF **ELECTRONICS** plus the **BUYERS' GUIDE**

Whatever other dilemma the advertising budget planner may be in, he is in agreement on one salient point: *advertising, to develop maximum effectiveness, must be continuous.* Nothing, absolutely nothing, pays off on the long run more than getting potential buyers familiar with your product and trade name by way of consistent, all-the-year-'round advertising. Once ascertaining what your market is, the logical approach is to keep your product in view of this market through continuous, consistent advertising.

For instance, the value of continuity in advertising was demonstrated by a series of surveys conducted by McGraw-Hill's Research Department. It was found through the results of these surveys that continuity in advertising increased the recognition of an electronic firm's products 26% in nineteen months.

For the budget planner with an electronic account, there is a ready-made promotion

package for the consistent, continuous year 'round advertising program. That program is 12 regular issues of **ELECTRONICS** plus the 1 issue of the **ELECTRONICS BUYERS' GUIDE** . . . 13 insertions for 1956! Here you will reach more than 40,000 subscribers who *pay* to get **ELECTRONICS** — owners, partners, corporate officers, managers, department heads, chief engineers and especially: electronic, electrical, design and research engineers; in brief, the people of the industry who are responsible for buying the products you promote in the sales pages of **ELECTRONICS** and the buying reference pages of the "Guide." With a consistent, continuous advertising program in 13 issues of **ELECTRONICS** (12 regular issues plus the "Guide") manufacturers have discovered that they get the greatest return from their advertising dollar investment because **ELECTRONICS** reaches the men who influence purchasing.

BUDGET NOW FOR 13 INSERTIONS IN '56!



electronics

A McGraw-Hill Publication



BUYERS' GUIDE



330 West 42nd Street, New York 36

Extend your future in

CIRCUIT DESIGN

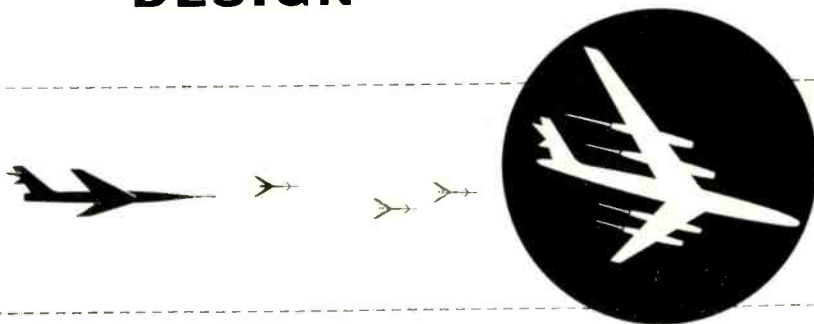

At Hughes we have undertaken development of a system in which advanced radars using array antennas and newer traveling wave tube developments are combined with digital data handling and processing equipment to solve the complex problems of aircraft detection and assignment.

We are already in an enviable position in the intercept and destruction phase of defense through the Hughes airborne radar fire control systems and the Hughes Falcon guided missile. Achievement of these objectives in the very limited space and stringent environmental conditions of the modern defense system provides an unusual challenge to the creative circuit design engineer.

If you are interested in joining us you should have experience in one or more of the following circuit areas:

Transistor—Video—Microwave—Pulse—IF and RF—Switching—Clamping—Phase Shift—Power Supply—Modulator—Electromechanical.



Scientific Staff Relations

HUGHES

RESEARCH AND DEVELOPMENT LABORATORIES

Culver City, Los Angeles County, California

NEW PRODUCTS

(continued)

—65 C to 125 C with altitude to 70,000 ft.

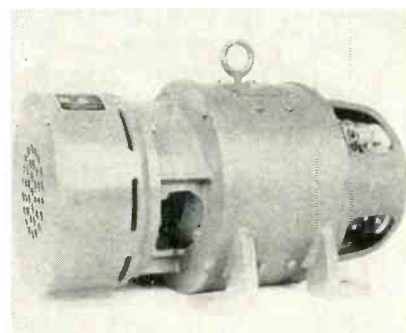

CONVERTER

28 v d-c to 400 cycle a-c

GEORATOR CORP., Manassas, Va., has developed the unit illustrated to meet the need for a converter to supply 400 cycles where only 28 v d-c is available. It consists of a continuous duty, 28 v d-c motor, direct coupled to a Nobrush generator. The generator rotor is mounted directly on the motor shaft and the generator stator and its housing bolted directly to the motor housing. This eliminates couplings and results in an overall size little greater than that of the motor alone. The converter pictured delivers 1.5 kva single phase 400 cycles, 115 v. Other outputs are available. Two or three phase can also be supplied on the output. No brushes, slip rings or commutators are used in the generator. Thus there is no r-f interference originating there, and virtually no maintenance required for the generator portion.

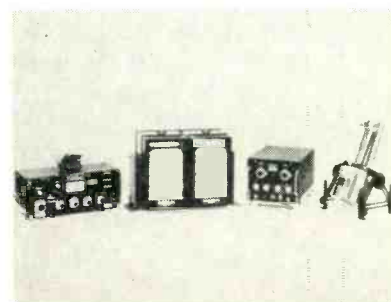

SCINTILLATION COUNTER

for geophysical exploration

MT. SOPRIS INSTRUMENT CORP., 1320 Pearl St., Boulder, Colo., has announced the model SC188DA air-



Puts your business on a cash basis

If you are an electronics manufacturer or a wholesaler with annual or potential sales of \$1,000,000 or more you can profitably use our kind of banking service to provide increased working capital without increased indebtedness or dilution of profits.

Why not investigate this modern approach to your money problems and learn how you can put your business on an all-cash basis, with wider opportunities for sales and profits.

More than four hundred companies in various industries are now profitably using our banking services.



Textile Banking Co., Inc.

Providing operational financing for manufacturers and distributors of furniture, apparel, electronics, plastics and textiles.

55 Madison Avenue, New York 10, N. Y.

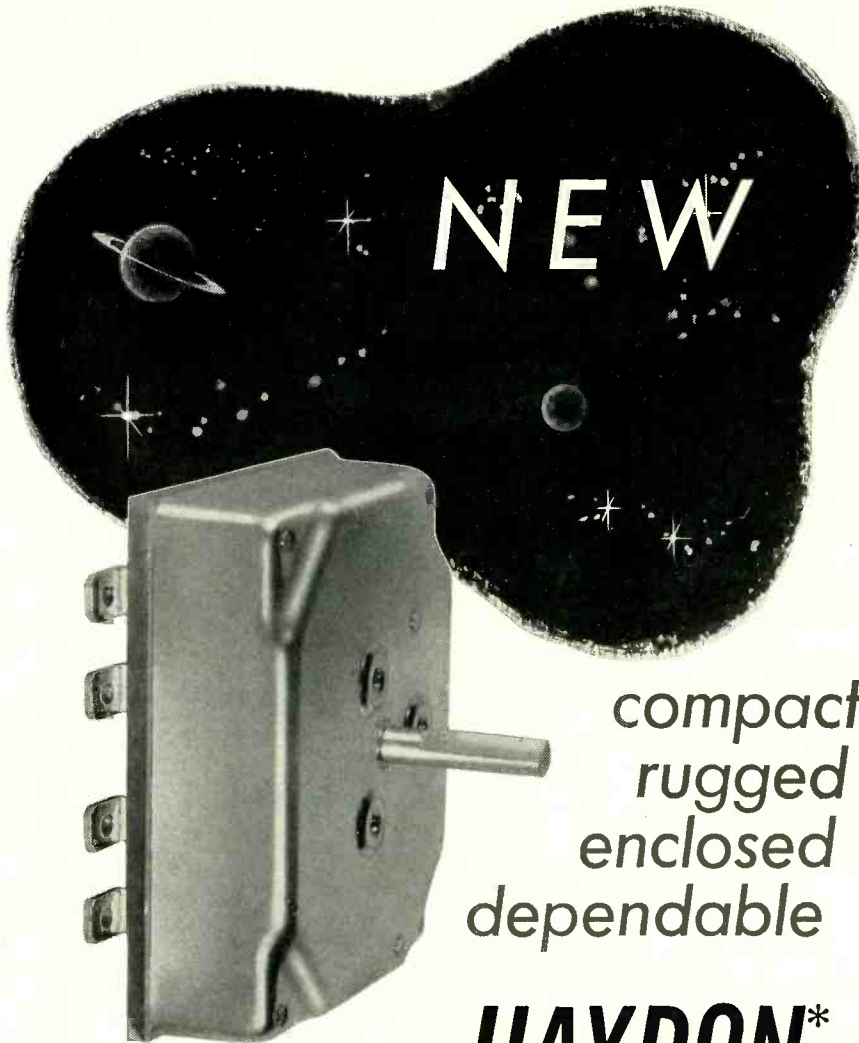

compact
rugged
enclosed
dependable

HAYDON* APPLIANCE TIMER

A new Haydon Interval Timer with the rugged construction needed for long appliance life . . . at an attractive price. Highest quality throughout. New cantilever contact principle gives crisp break and fast, sliding contact make. Number or type of terminals can be specified. Roller-cam follower minimizes wear and contributes to smooth, easy-turning settings in either direction. Unusual compactness and all-position operation allows freedom in choice of timer location.

If the HAYDON Field Engineer in your area has not shown you this new Series 8028 Interval Timer — write for information.

*Trademark Reg. U.S. Patent Office



A SUBSIDIARY OF GENERAL TIME CORPORATION

HAYDON Manufacturing Company, Inc.
2435 ELM STREET, TORRINGTON, CONN.

borne-carborne scintillation counter. Some of the features are: dual level discrimination against high and low energy radiation for limited spectral selection; range expanding at no sacrifice in sensitivity with a zero displacement control; synchronous logging of absolute altitude and counting rate with a dual recorder; and advanced circuitry for high pulse resolution, linearity and accuracy. The system is completely shock mounted and uses ruggedized vacuum tubes throughout. A 4-page folder contains illustrations and specifications.

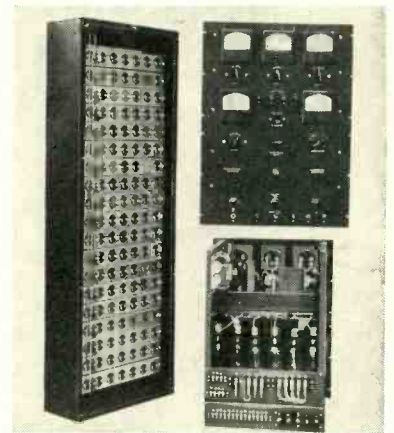

POWER SUPPLIES with 0.5 percent regulation

NJE CORP., 345 Carnegie Ave., Kenilworth, N. J. A new group of high-current regulated supplies exhibit the characteristic of zero recovery time from a line or load transient. Designed around a fast-response thyatron rectifier, a stiff filter, and a large output storage capacitance, these units have been successfully used in computers, telemetering systems and aircraft-control applications in which the power supply must simulate an ideal battery. Instead of the 200 to 500-millisecond time-lag between a step change in line or load and the correction for it, in the zero-lag system the voltage never leaves the regulated region. Standard regulation is 0.5 percent against static line changes of 20 percent, static load changes of 100 percent, dynamic line changes of 10 percent, and dynamic load changes of 25 percent. Standard ripple is less

Why take **"FISHERMAN'S LUCK"?** ...

trying to pick the correct resistors for your circuits from "stock" items or catalog pages? Specify GLOBAR® Resistors and be *sure* of getting *exactly* what you want.

Over ninety percent of the GLOBAR® Resistors made are "custom-engineered" in the correct sizes, shapes, resistance values and characteristics—to solve *specific* circuit problems. Try us and see!

It costs no more to use

GLOBAR®

Ceramic Resistors

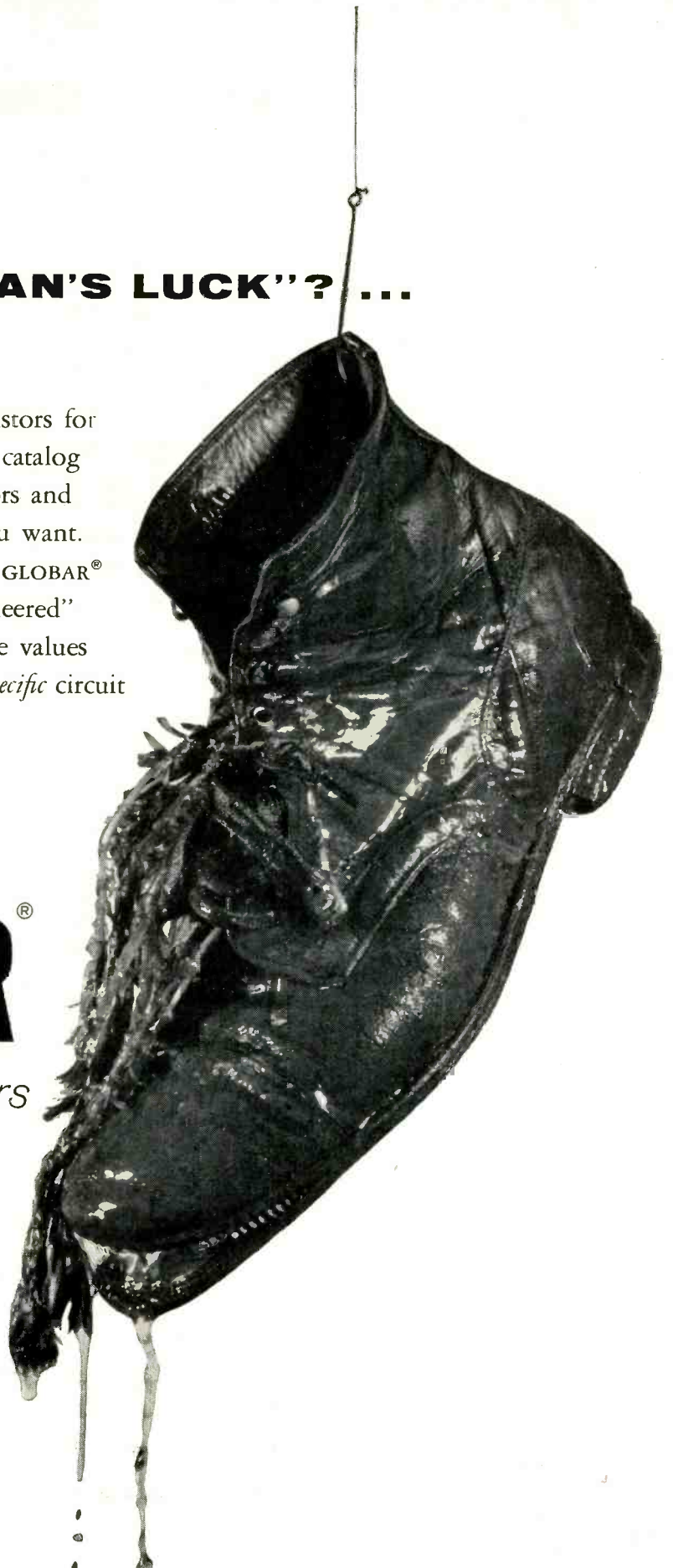

GLOBAR Division, The Carborundum Company, Niagara Falls, New York



SERVO MOTOR-GENERATORS FOR EVERY PURPOSE

Kearfott Servo Motor-Generators are characterized by low rotor inertia, low time constants and high stall torque. Motor-Generator combinations provide 1/2 to 3.1 volts per 1000 R.P.M. with an extremely linear output over a speed range of 0—3600 R.P.M. and useful output up to 10,000 R.P.M.

CHARACTERISTICS				
TYPE	MOTOR		GENERATOR	
	STALL TORQUE	NO LOAD SPEED	OUTPUT FUND. NULL	LINEARITY
DAMPING				
SIZE 10	.35 OZ. IN.	6000	21/1	.5%
SIZE 10	.30 OZ. IN.	8500	23/1	.5%
SIZE 11	.63 OZ. IN.	5900	25/1	.5%
SIZE 15	1.5 OZ. IN.	5000	25/1	.5%
SIZE 18	2.4 OZ. IN.	5000	25/1	.5%
SIZE 18	3.0 OZ. IN.	9600	23/1	.5%
RATE				
SIZE 15	.45 OZ. IN.	10,500	170/1	.5%
SIZE 15	1.5 OZ. IN.	4700	350/1	.2%
SIZE 18	2.4 OZ. IN.	4700	350/1	.2%
SIZE 18	3.0 OZ. IN.	8400	350/1	.2%
*INTEGRATOR				
SIZE 15	.70 OZ. IN.	6300	400/1	.1%
SIZE 15	1.25 OZ. IN.	4500	400/1	.1%
SIZE 18	1.35 OZ. IN.	7200	400/1	.1%
SIZE 18	2.4 OZ. IN.	5200	333/1	.05%
SIZE 18	3.0 OZ. IN.	8000	333/1	.05%

*Integrator Tachometers are temperature stabilized

Send for Bulletin describing Servo Motor-Generators of interest to you.

ENGINEERS

Many opportunities in the field of Precision components are open. Write for details today.



A SUBSIDIARY OF GENERAL PRECISION EQUIPMENT CORPORATION

KEARFOTT COMPANY, INC., LITTLE FALLS, N. J.

Sales and Engineering Offices: 1378 Main Avenue, Clifton, N. J.
 Midwest Office: 188 W. Randolph Street, Chicago, Ill. South Central Office: 6115 Denton Drive, Dallas, Texas
 West Coast Office: 253 N. Vinedo Avenue, Pasadena, Calif.

than 0.1 percent. Thirty stock models are described in catalog Z-5.

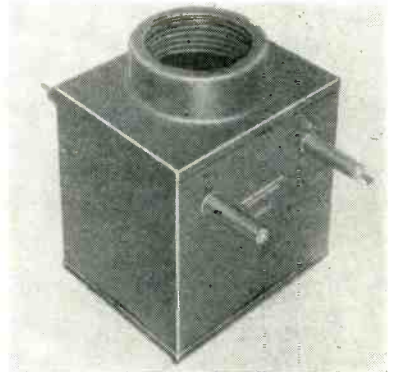

PULSE TRANSFORMER features high power rating

FISHER ENGINEERING, INC., Huntington, Ind. The D211C4B pulse transformer will handle 15,000 v. The transformer is designed to operate with pulse widths of 20 μsec and features a rise time of less than 1 μsec. Duty cycle is 4 milliseconds, continuous. Total maximum variation of output pulse from nominal peak value is less than 5 percent. Weighing 45 lb, the unit measures 8 by 6½ by 9 in., including four stud mounts on the base, but not four 3-in. feedthrough insulators on the primary and secondary sides. The transformer is hermetically sealed and oil filled, and has the bellows-type expansion drum.

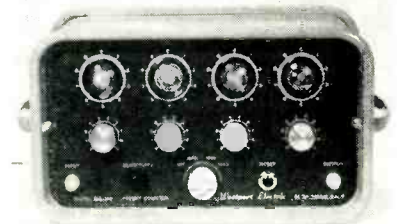

PRESET COUNTER has 0 to 5,000 pps response

WESTPORT ELECTRIC, 149 Lomita St., El Segundo, Calif. Model WE-310 is a small, lightweight preset electronic counter featuring basic simplicity and long term dependability. An operator may set in any number from 1 to 9,999 by rotating each of the four decade

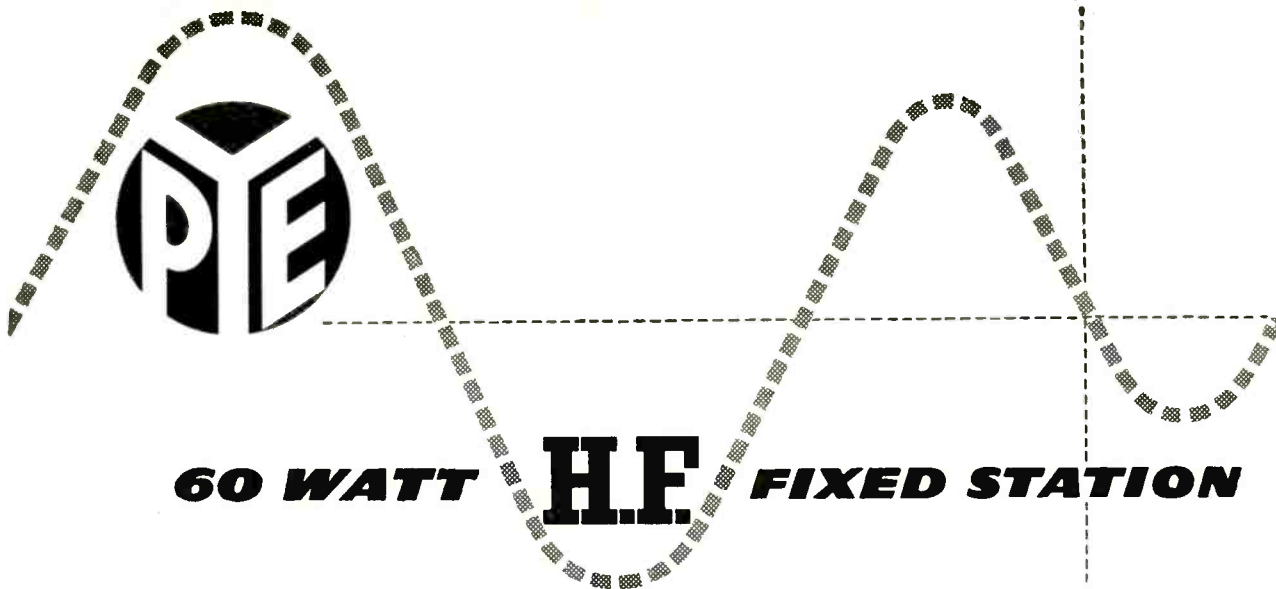

60 WATT H.F. FIXED STATION

This completely new Pye equipment has been specifically designed for point-to-point communication and will fulfil equally well a ground-to-air role in air traffic control systems.

Push button control brings any one of four preselected channels into immediate operation; this facility is also available when the equipment is installed for remote unattended operation. The 60 watt Fixed Station Transmitter offers R/T, C/W, or M.C.W. operation with 'break-in' facilities on telegraphy.

The equipment is suitable for unattended operation in the tropics.

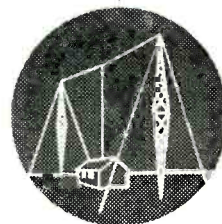
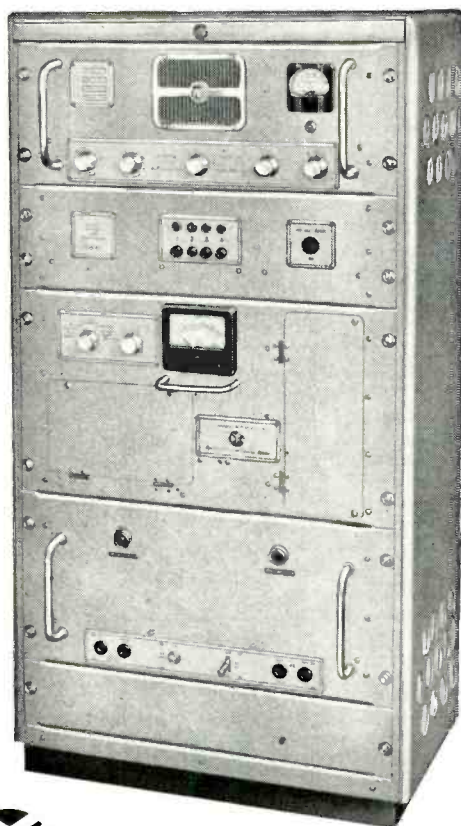

Telecommunications

CAMBRIDGE ENGLAND



<p>Pye (New Zealand) Ltd. Auckland C.I., New Zealand</p> <p>Pye Radio & Television (Pty.) Ltd. Johannesburg South Africa</p> <p>PYE LIMITED</p>	<p>Pye Canada Ltd. Ajax, Canada</p> <p>Pye Limited Mexico City</p> <p>CAMBRIDGE</p>	<p>Pye Pty Ltd. Melbourne, Australia</p> <p>Pye Limited Tucuman 829 Buenos Aires</p> <p>ENGLAND</p>	<p>Pye (Ireland), Ltd. Dublin, Eire</p> <p>Pye Corporation of America 270 Park Avenue New York</p>
--	--	--	--

Telephone: Teversham 311

MORE WAYS TO SQUEEZE PENNIES OUT OF UPSET SPECIALS COSTS

Specially designed upset products are solving thousands of problems. Dozens of design pointers on them are yours for the asking. Send us your sketches, prints, finished products for suggestions.

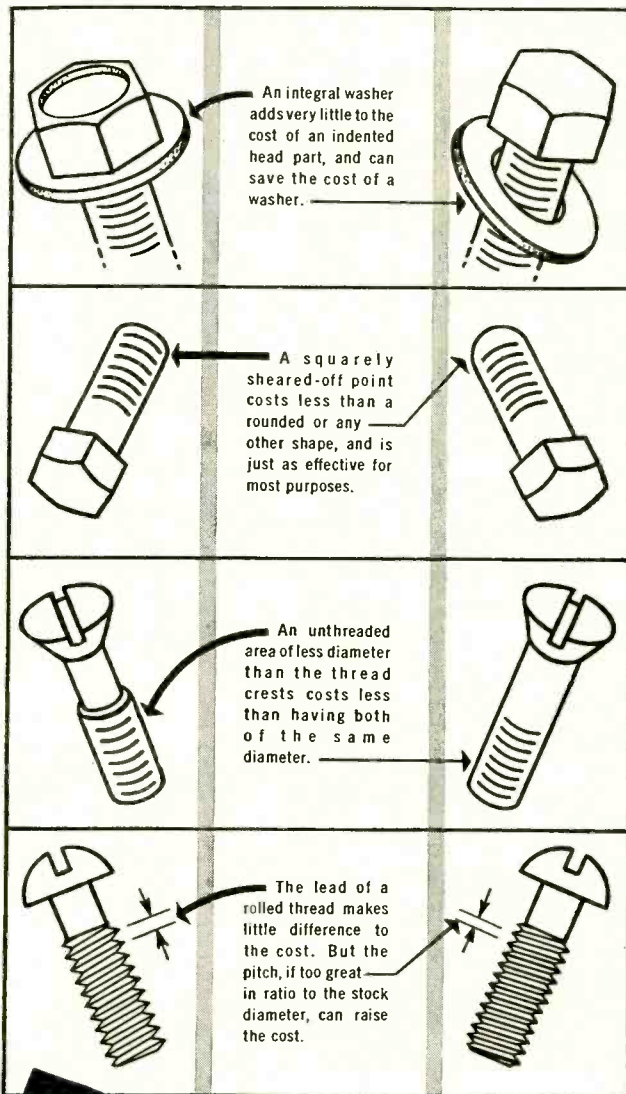

REPRINTS

of this chart are available on request for use in drafting and purchasing departments.



A HALF-CENTURY OF MACHINE SCREWS AND SPECIAL FASTENERS



WRITE FOR
OUR CATALOG

**THE PROGRESSIVE
MANUFACTURING COMPANY**
50 NORWOOD ST., TORRINGTON, CONN.

NEW PRODUCTS

(continued)

selector switches to the appropriate number. The unit will count until this total has occurred; then, coincident with the last input pulse, it provides an output pulse. Either of two modes of operation is selected by means of a front panel selector switch. On **CYCLE**, the WE-310 counts to the present number, produces an output pulse, resets itself automatically, and resumes counting. Thus, the instrument is ideal for grouping or batching any items which can be counted. In the **MANUAL** position of the selector, the instrument counts to the preset number and then opens or closes a pair of relay contacts which hold until the unit is manually reset. Response is 0 to 5,000 pps. Size is 6 by 6 by 11 in.; weight, 12 lb; price, \$449.

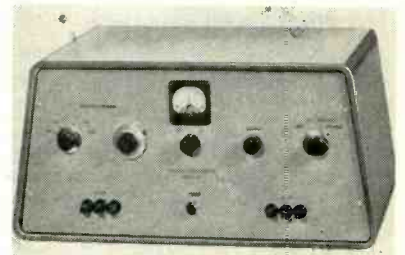

STABILIZED AMPLIFIER is wide-band type

PHOTRON INSTRUMENT Co., 6516 Detroit Ave., Cleveland 2, Ohio. Model D4 d-c amplifier has a gain of 50,000 with drift referred to input of less than 25 μ v per hr. Frequency response is d-c to 100 kc for gain up to 1,000. Gain is continuously adjustable from 0.001 to 50,000 by a 10-turn precision potentiometer and a 6-step decade attenuator. Accuracy of gain settings is ± 1.5 percent. Input impedance is 1 megohm. Either pen or string galvanometer can be driven directly from output. Adjustable frequency-compensation for the Photron pen galvanometer is provided.

MEGOHMMETER is battery operated

FREED TRANSFORMER Co., INC., 1715 Weirfield St., Brooklyn 27, N. Y. Model 2030 battery-operated portable megohmmeter measures

Fixed paper capacitors are cased

in low-loss **RESINOX* 10900**



MONSANTO PHENOLIC SELECTED BY JOHN E. FAST & CO. BECAUSE OF OUTSTANDING ELECTRICAL PROPERTIES

For components requiring low electrical loss characteristics at high frequencies, it will pay you to consider Resinox 10900 Natural.

This thermosetting material has proved its outstanding dielectric strength in a wide variety of critical radio, television and electronic applications. Its water absorption (percentage by weight) is rated at 0.03.

In addition to superior electrical loss properties, Resinox 10900 offers excellent moldability and fast cure, as well as low after-shrinkage.

Perhaps Resinox 10900 is exactly what you need to solve an electrical parts problem. Write today for full information. Monsanto Chemical Company, Plastics Division, Dept. E-11, Springfield 2, Mass.



*Resinox: Reg. U. S. Pat. Off.

Even for the special
"out of this world"
wiring problem . . .
a down-to-earth
solution —
Continental Wire

Whether it's a rocket to the moon or a radio for a room—chances are you'll find Continental ready to serve your wiring needs exactly—with both speed and efficiency.

With many quality insulations of Asbestos . . . Glass . . . Nylon . . . Varnished Cambric . . . Polyethylene . . . Polyvinyl . . . Teflon . . . Zytel, among others, Continental also offers a wide range of wire sizes—in stock and on special order. For instance, Continental's ELECTRONIC HOOK-UP WIRE. This nylon-insulated, hook-up wire saves TIME . . . LABOR . . . and GUESS-WORK in assembly. Resistance to abrasion, acids, alkalis and petroleum solvents—and temperatures ranging from -50°C to $+125^{\circ}\text{C}$ —assures dependability plus versatility. Available in AWG SIZES 18 to 32.

One source to . . . our many wiring requirements—Continental. Write today for Continental's complete catalog of heat-resistant, moisture-resistant wires, cables and cords. Serving 600-5000 volts. Sizes, 18 AWG—2,000,000 CM.

Continental's industrial wire and cable specialists are available to serve you at any time.

Contact: Continental Sales, Box 363, Dept. C
Wallingford, Conn., Phone COlony 9-7718

Continental
WIRE CORPORATION
WALLINGFORD, CONNECTICUT • YORK, PENNSYLVANIA

leakage resistance from 5 megohms to 10,000,000 megohms in 5 ranges with an accuracy of ± 3 percent. A regulated 500 v supply is incorporated in the instrument for supplying test potential. The instrument is entirely self contained, safe and rapid to use. Readings are obtained instantaneously on a large easy-to-read meter. Battery drain has been reduced to a minimum in order to insure long term reliable operation. A standard resistor is incorporated for fast checking of instrument accuracy and calibration. For further information on model 2030 and the complete Freed catalogs covering transformers and laboratory test instruments, write directly to the manufacturer.

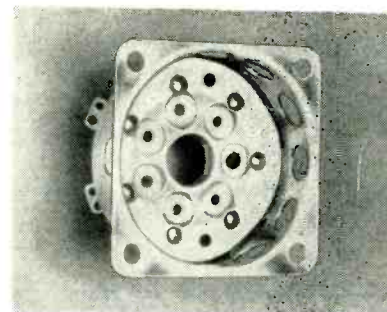

TUBE SOCKET
is 7-pin, steatite insulated

E. F. JOHNSON Co., Waseca, Minn. A compact new vhf septar steatite insulated tube socket requires $\frac{1}{2}$ in. less chassis mounting space than previously available types. The socket has an integral ventilated aluminum shield base which submounts the tube for optimum input and output shielding. The socket will permit more compact equipment design in mobile, aircraft and other types of transmitting equipment.

POTTING PLASTIC
is Teflon based

TOPPER MFG. Co., INC., 43 Roselle St., Mineola, L. I., N. Y. Electroplast is a new development in the field of potting plastics. It is a Teflon based general purpose encapsulating plastic, hardened through addition of an activated curing agent which permits the curing to proceed at room tem-

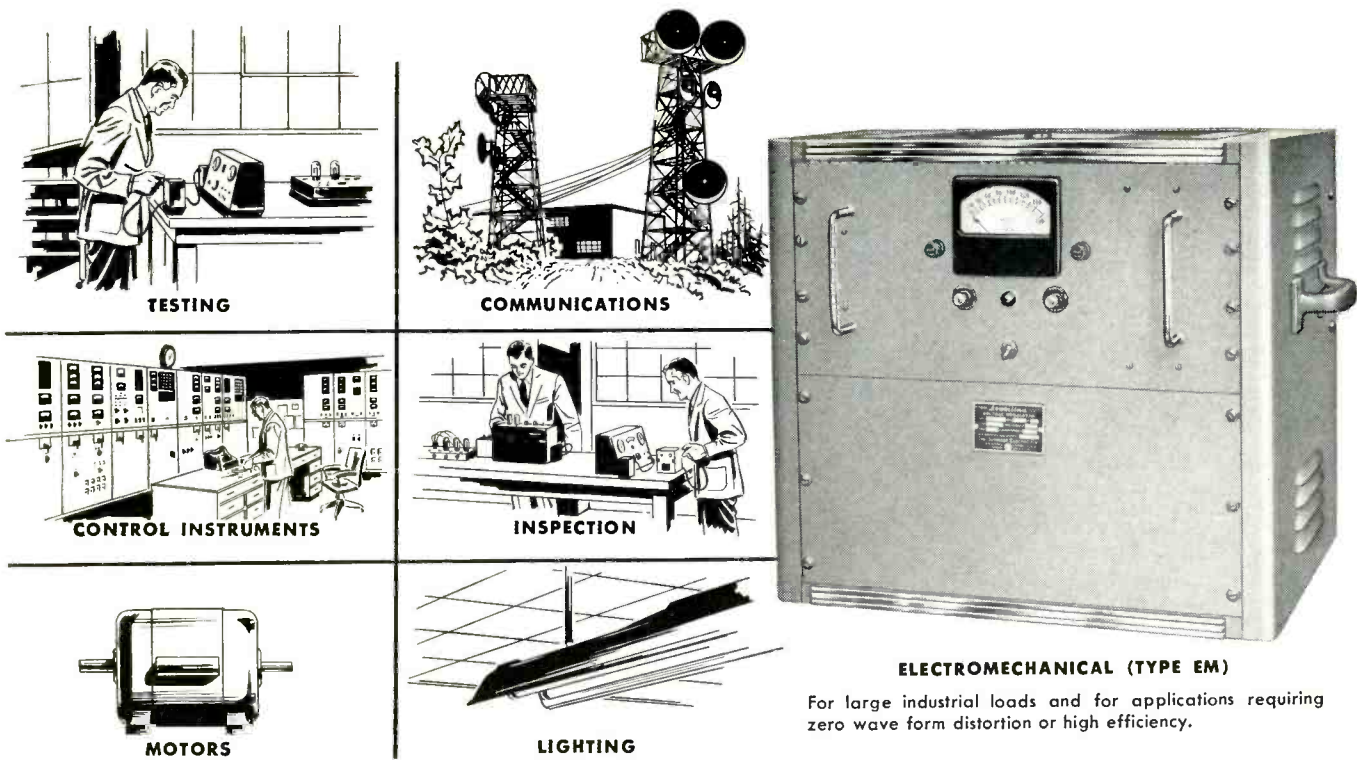

ELECTROMECHANICAL (TYPE EM)
 For large industrial loads and for applications requiring zero wave form distortion or high efficiency.

STABILINE AUTOMATIC VOLTAGE REGULATORS TYPE EM

*Get
 Zero Wave Form
 Distortion -
 with Precise
 Root Mean Square
 Voltage Control*

When you use *heat, light, sound, power or electronic gear*, you need to control voltage to closer limits than it is available commercially.

In thousands of installations the STABILINE Automatic Voltage Regulator type EM has proved itself a rugged "work horse" and an accurate means of maintaining *root mean square* voltage — the rating for which all electrical equipment is designed. Its zero wave form distortion makes it a "must" for many types of electronic equipment. Its efficiency is comparable to fixed-ratio transformers.

STABILINES type EM are available in 115, 230 and 460 ratings for single and three phase duty in capacities up to 100 KVA with correction speeds from .075 to .32 seconds per volt. Send for bulletin for full details.



See Superior Electric's Mobile Display when it is in your area.



THE SUPERIOR ELECTRIC COMPANY

SALES OFFICES: The Superior Electric Company
 1436 N. Serrano Avenue
 Hollywood 27, California
 P. O. Box 946, 2881 El Camino Real
 Redwood City, Cal.
 453-A Eglinton Ave., West, Rm. 202
 Toronto 12, Ontario, Canada
 P. O. Box 48, 721 So. Boulevard
 Oak Park, Illinois

REPRESENTATIVES
 Beryl R. Hill Co.
 17481 James Couzens Hwy
 Detroit 35, Mich.
 Fred H. Haight Co.
 2212 Equitake
 Seattle 2, Wash.

THE SUPERIOR ELECTRIC COMPANY
 217 Reynolds Avenue, Bristol, Conn.

Please send my copy of the STABILINE Bulletin.

Name.....
 Position.....
 Company Name.....
 Company Address.....
 City..... Zone..... State.....



takes $\frac{1}{3}$ less space
than previously
available types

NEW!

smaller socket for septar based tubes such as the 5894, 6524, 6252

Considerably smaller than previously available types, this new 7-pin VHF septar socket permits compact design in mobile, aircraft, and other types of transmitting equipment. Bases on all three types are grade L4 steatite, glazed on top and sides—underside DC200 impregnated.

Available in three grades to meet all applications:

Standard—122-105-1
Industrial—122-105-100
Military—122-105-200

Contacts on the standard grade are cadmium plated, with brass clips and steel springs. Contacts on industrial and military grades consist of phosphor bronze clips with beryllium copper springs. Contact plating on industrial type, .0005 silver; military, .001 silver. Aluminum shell finish is etched on standard; Iridite No. 14 on industrial and military types.

Additional Features

- Molded recesses in base for each contact—prevents turning
- Contact cushion washers of fungus resistant glass base melamine
- Sockets molded with pin circle groove and recessed tube pin holes for easy tube insertion
- Aluminum shell submounts tube for optimum input and output shielding, $\frac{3}{8}$ " hole provides adequate ventilation.

Special Types Available

Wafer socket alone, without shield base. Sockets with special grid terminal for direct mounting of components.

Write today for prices or further information.

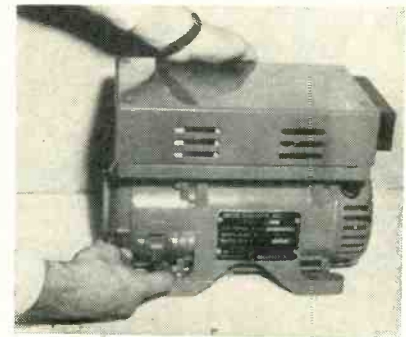
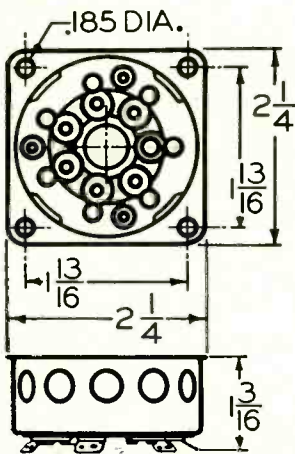

AIRCRAFT INVERTER is a high-output unit

LELAND ELECTRIC Co., division of American Machine & Foundry Co., 1501 Webster St., Dayton 1, Ohio. A new 41-lb aircraft inverter, model SE-24-1, rated 2,250 v-a at 35,000 ft (44 C) is being produced. As the inverter has electronically controlled carbon piles which regulate power for shunt and exciter fields, both voltage and frequency modulation are a fraction of the allowable specification value resulting in a reduction in the noise level of the servo system. The unit measures $13\frac{1}{4}$ in. long by $9\frac{1}{4}$ in. high by $7\frac{1}{2}$ in. wide.

TWIN-TRIODE for tv cascade use

GENERAL ELECTRIC Co., Schenectady 5, N. Y., has developed the 6CH7 twin-triode for tv cascade r-f amplifier circuits. It is designed to give considerably more gain and a better noise factor on the higher vhf channels than previous cascade tubes. The increased gain is achieved by a new basing connec-



E. F. JOHNSON COMPANY

2334 Second Avenue Southwest • Waseca, Minnesota

We took the out of vacuum !

Here's the kind of curve an ordinary vacuum pump plots on a vibrograph. This might be called "nerve-shattering" performance.

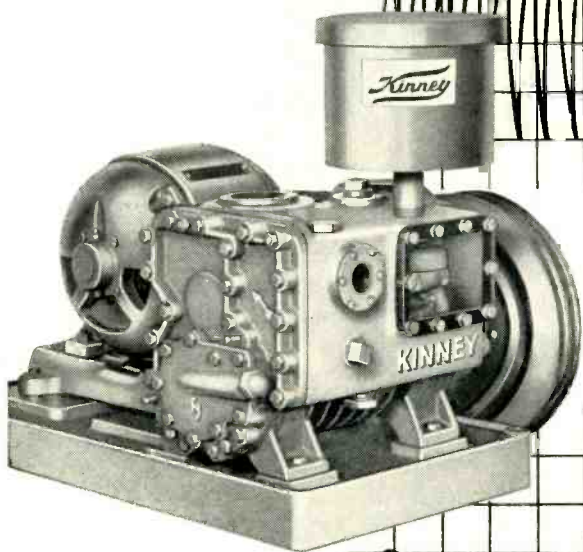
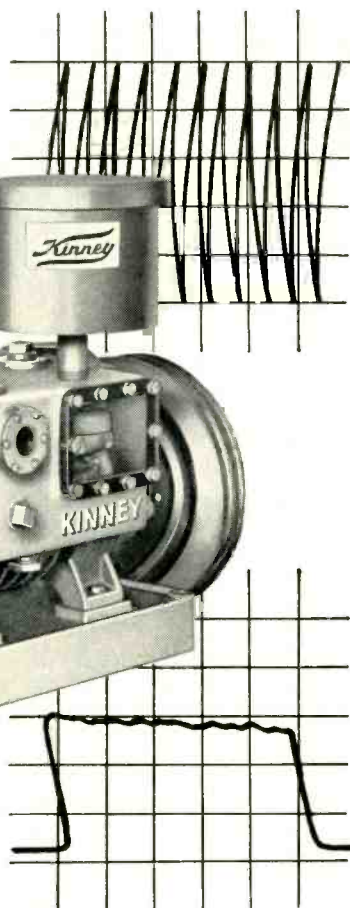

Kinney dynamically balanced Pumps plot a curve like this. If you need vacuum, balanced performance is another reason why you need Kinney.

Vibration, that is. Yes, the complete line of Kinney Compound High Vacuum Pumps, now dynamically balanced, is functionally vibration-free . . . another big plus for Kinney:

Ideal for Portable Jobs — Balanced performance is vitally important on light flowing vacuum jobs — and also on cabinet-enclosed installations.

Easier Installation, Less Maintenance — No need for flexible tubing to isolate pump from piping. Less vibration also means longer life for connecting piping, fittings, valves, etc.

Write us today for information of Kinney Balanced Compound Vacuum Pumps—and also about conversion kits for gaining vibration-free performance from Kinney Pumps now in use. Kinney Manufacturing Division, Boston 30, Mass. District offices in Boston, New York, Philadelphia, Cleveland, Chicago, and Los Angeles are all competently staffed to discuss vacuum with you. Los Angeles office carries complete stock and has full service facilities.

WRITE TODAY

KINNEY MFG. DIVISION
THE NEW YORK AIR BRAKE COMPANY
3565 WASHINGTON STREET • BOSTON 30 • MASS.
INTERNATIONAL SALES OFFICE, 90 WEST ST., NEW YORK 4, N.Y.



Please send engineering information on Kinney Dynamically Balanced Vacuum Pumps.

Name

Company

Address

City State

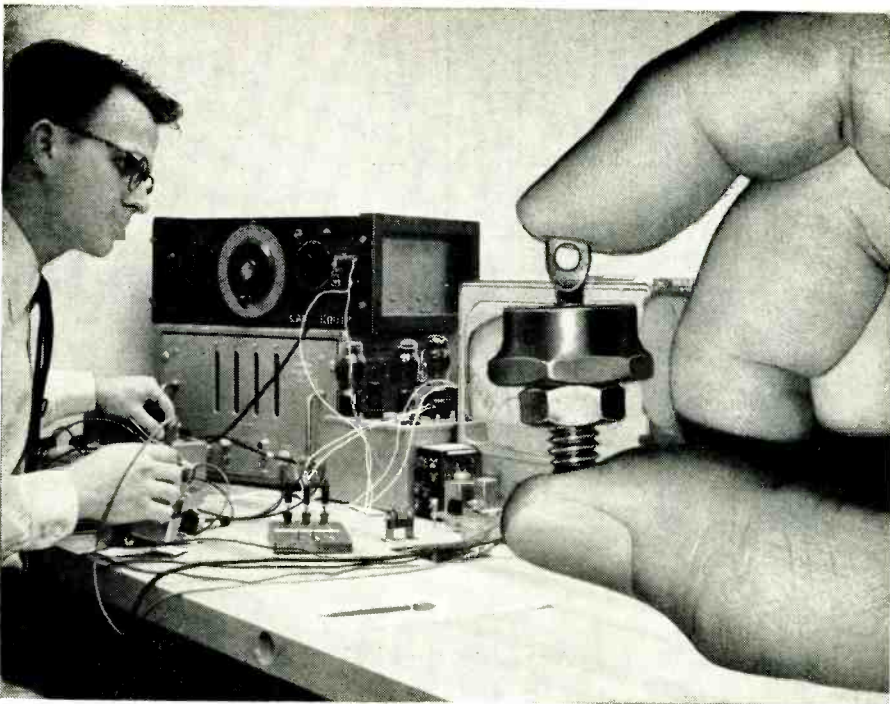

tion featuring two cathode leads for the driven-grid section, with the shield between sections internally connected to the grid of the grounded-grid section. Ratings in typical operation as a class A1 amplifier show that with 150 plate volts and a 220-ohm cathode bias resistor, each section has an amplification factor of 36, plate resistance of 5,300 ohms, and transconductance of 6,800 μ mhos.

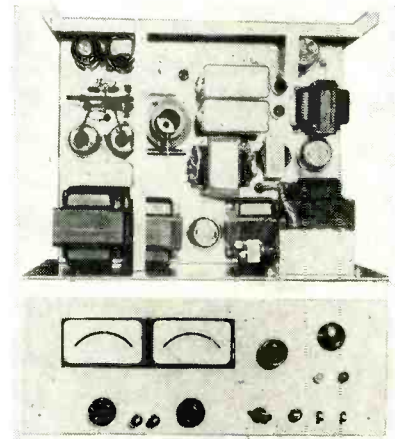

H-V POWER SUPPLY
has 8 ma output at 5,000 v

NEUTRONIC ASSOCIATES, 87-16 116th St., Richmond Hill 18, N. Y. Model R-500A high-voltage power supply is a precision type instrument designed for extra stable, well filtered and uniform operation. Voltage range is 100 v to 5,000 v d-c; current output, 8 ma at 5,000 v; output polarity, either positive or negative, is switch controlled on front panel; regulation, 0.5 percent or better, no load to full load, and with line voltage variation from 105 to 130 v; stability, 0.25 percent; ripple 0.05 percent; and response time, better than 5 milliseconds from 1 kv to 5 kv.

I-F AMPLIFIER
has 100-db gain

LINEAR EQUIPMENT LABORATORIES, 380 Oak St., Copiague, Long Island, N. Y., has announced a new addition to its line of miniature and sub-miniature i-f amplifiers. The model I.F. 30 is intended for direct incorporation into prototype radar equipments. It has 100-db gain,

WESTINGHOUSE
NEW SILICON POWER
RECTIFIER puts you ahead...

High-temperature operation. Exhaustive tests have shown that these units are capable of operation up to 200°C with no detectable aging in their characteristics.

In rectifier efficiency. Forward voltage drop reaches only 0.85 volts at 40 amperes, 190°C junction temperature. Efficiency is over 99%. Ratings up to 200 volts maximum peak inverse are available in four classifications: 50, 100, 150 and 200 volts.

In compact design. Westinghouse silicon power rectifier (shown actual size above) takes only 1/50th the volume of the comparable selenium rectifier.

Write today for your free application *Facts Folder* describing the full range of silicon power rectifier characteristics. These rectifiers are available for immediate delivery. Call your local Westinghouse sales office, or write: Westinghouse Electric Corporation, 3 Gateway Center, P. O. Box 868, Pittsburgh 30, Pa.

J-80002



YOU CAN BE SURE...IF IT'S
Westinghouse



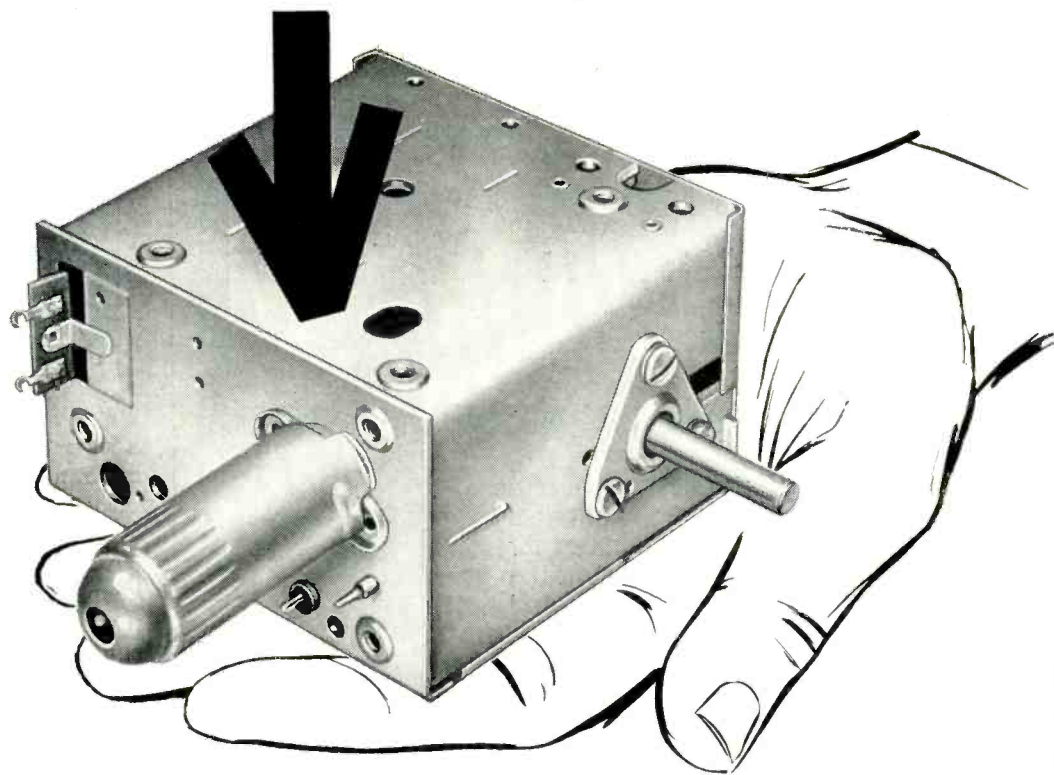

NEW

low cost UHF tuner

FEATURES OSCILLATOR RADIATION FIXES

Here's famous R/C quality at the lowest price ever! The new T-90 Series uhf t-v tuner meets all RETMA spurious radiation requirements. Yet it costs less than any previous Radio Condenser uhf tuner.

The double-circuit tuned T-90 Series has excellent i-f and image rejection, giving remarkably high selectivity. As indicated by R/C statistical quality control, the noise figure of the new tuner exceeds most requirements, and the drift characteristics are equally good. Field results to date have been uniformly excellent.

If you want information fast on the T-90 Series, we'll be happy to have one of our engineers call at your convenience.

Get Complete Engineering and Performance Data.
Write Radio Condenser for your free copy of Bulletin T-90.

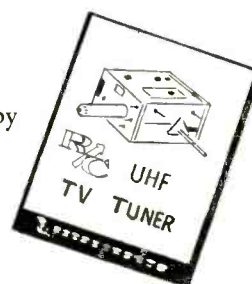

RADIO CONDENSER CO.

Davis & Copewood Streets • Camden 3, New Jersey

EXPORT: Radio Condenser Co., International Div., 15 Moore St., N.Y. 4, N.Y. CABLE: MINTHORNE
CANADA: Radio Condenser Co., Ltd., 6 Bermondsey Rd., Toronto, Ontario

Fairchild Guided Missiles Division Offers:

CHALLENGING WORK, RECOGNITION

to Outstanding Engineers

Pioneer in guided missile development and production, Fairchild Guided Missiles Division now has openings for outstanding engineers who want the opportunity to advance their fields and work at the forefront of a challenging, stimulating guided missiles program.

**MISSILES ENGINEERS
AERONAUTICAL ENGINEERS
STRUCTURAL ENGINEERS
ELECTRONICS ENGINEERS
PROPULSION ENGINEERS**

Fairchild wants imagination and originality in engineers with proven ability and long experience in these fields:

**ADVANCED RADARS
COUNTER MEASURES
MICROWAVE NAVIGATIONAL SYSTEMS
COMPUTER CIRCUITRY
DIRECTION FINDERS
AUTOMATIC RADAR
SPECIAL RECEIVERS & TRANSMITTERS**

The men chosen can have splendid futures and ample reward for their own contributions to Fairchild's growing guided missiles program.

They'll find their work constantly challenging, constantly fascinating. And, they'll find attractive Long Island a wonderful place to live. Housing is excellent; recreational facilities are superb.

**SEND YOUR RESUME
TODAY TO:**

Personnel Manager
Fairchild
Guided Missiles Division
Wyandanch, N. Y.

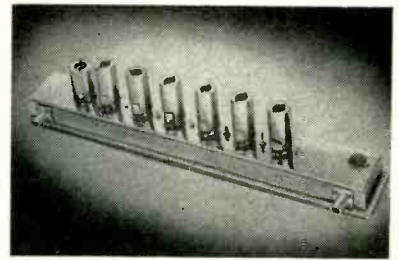

2-mc bandwidth and incorporates a low noise cascode input. The mechanical design permits ready modification of input and output circuitry and impedance for any particular application, thus greatly simplifying the engineering design problems of i-f portions of new equipments. Complete data on linear i-f strips is available on request.

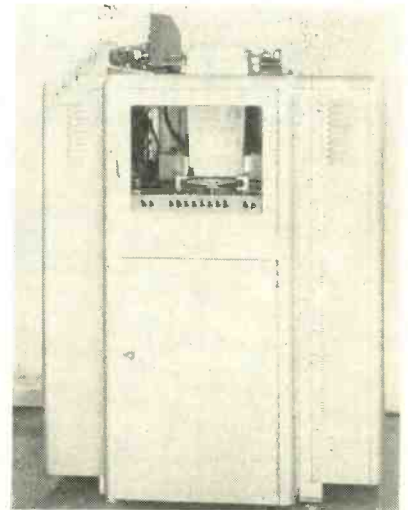

FLYING TYPEWRITER

Uses ferrite-core memory

POTTER INSTRUMENT CO., INC., 115 Cutter Mill Road, Great Neck, N. Y., has put into production a magnetic core memory storage which reduces the number of tubes in the Flying Typewriter (high-speed electronic printer) to less than 300. Printing speeds have been stepped up considerably so that the printer can now print up to 36,000 characters per minute of alphanumerical data and 72,000 impressions per minute of strictly numerical characters. This is equivalent to 15 lines, 80 columns wide, per sec. A standard Flying Typewriter consists of the printer, magnetic storage and power supply cabinets and a type 902 magnetic tape handler. Data can be fed into



"where the future is measured in light-years"

ENGINE AND AIRPLANE CORPORATION

FAIRCHILD

Guided Missiles Division

WYANDANCH, N. Y.

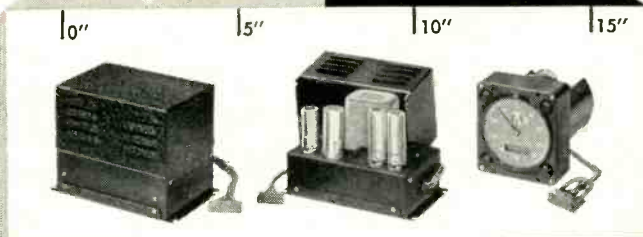

Equipment to indicate phase angle difference between two like frequency signals received over radio links. One chassis is a 400-cycle oscillator supply for two indicators. The other chassis combines impedance matching and a servo amplifier for one indicator. Complete system includes an oscillator, two indicators, two amplifiers.

servo problems stock units can't solve

This equipment "does the job right" because it was especially designed for a single application . . . by a company whose major function is solving individual servo control problems with complete, precisely engineered and manufactured servo assemblies.

Of course, if you just want servo *components*, Transicoil can provide them to the highest order of precision and accuracy. But it is in the "package" engineering of unique assemblies that Transicoil's experience and creative imagination offer the greatest value. And in most cases, these assemblies cost no more than the individual components would purchased separately.

Check out your next servo problem with Transicoil first. Ask for the new gear-motor availability guide if you haven't yet received a copy.

Transicoil
C O R P O R A T I O N
 Worcester • Montgomery County • Pennsylvania

Eccosorb CH

Microwave Absorber

for Darkrooms



Microwave Darkroom with Emerson & Cuming Luneberg Lens under test

Eccosorb CH is a series of broadband absorbers reflecting less than 2% of the energy incident upon its surface. It is composed of enmeshed, rubberized fibers and made in sheets 2 feet by 2 feet in various thicknesses. Eccosorb CH is light weight and flexible. It is easily mounted and its natural, white surface color gives good light reflection.

Free Space Rooms are easily and economically built for indoor antenna measurements. Reflections are eliminated for all practical purposes. You can build your own microwave dark room or **we offer you a complete Free Space Room ready to use.** Emerson & Cuming engineers design and build special types for unusual conditions. Send us your specifications.

Another absorber, ECCOSORB HF comes in rods, sheets or molded shapes in several volume resistivities for waveguide terminations and similar uses. If you have a problem write for information on . . .



Plastics for Electronics

Emerson & Cuming, Inc.

869 WASHINGTON STREET, CANTON, MASS.

Sales Representatives

KANSAS CITY
ENGINEERING SERVICES COMPANY
4550 Main Street, Kansas City 11, Mo.
Jefferson 7765

ST. LOUIS
ENGINEERING SERVICES COMPANY
6635 Delmar Blvd., St. Louis 5, Mo.
VO 3-3661

NEW YORK
M. RAYMOND KALLMAN
P. O. Box 104, Roslyn, L. I., New York — Roslyn 3-6511

DAYTON
ROBERT G. SIFF & ASSOCIATES
11 W. Monument Bldg., Dayton 2, Ohio
Hemlock 1254

WASHINGTON, D. C.
TED BRITT
1500 Mass. Ave., Washington 5, D. C.
Columbia 5-2694

- PLASTIC FOAMS
- LAMINATING AND IMPREGNATING RESINS
- PLASTIC-FIBER GLASS LAMINATES
- HIGH DIELECTRIC CONSTANT PLASTICS
- METALIZED PLASTICS
- ELECTRONIC EMBEDMENTS
- CASTING RESINS
- LOW LOSS ROD AND SHEET STOCK
- MICROWAVE ABSORBERS

NEW PRODUCTS

(continued)

the printer from punched or perforated tape handlers or directly from a high-speed digital computer, however.

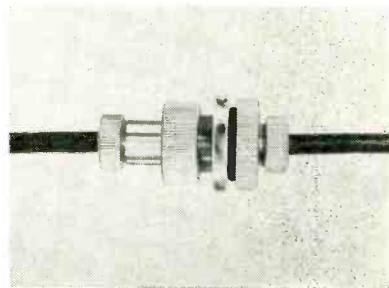

CONNECTORS

are pressure and water-proof

MIDWESTERN INSTRUMENTS, Indianapolis, Ind. The PW-51 pressure-proof and water-proof connectors are available in 5 sizes with AN-type inserts. All sizes are machined from Naval brass bar stock or aluminum bar stock. The standard finish on brass is polished chrome; however, they are obtained with or without plating. The aluminum connectors are clear anodized. These connectors were designed to be not only waterproof, but to also withstand pressure in excess of 200 lb per sq in. They will withstand the severe use which military requirements impose without breaking or leaking. Pressure-proof caps are available to fit both plugs and sockets.

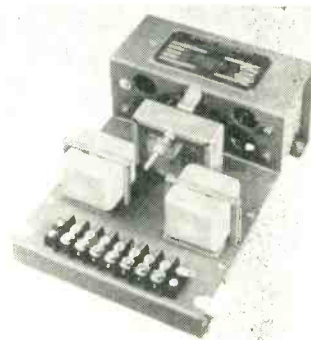

V-F CONTROL

for motor alternator sets

ELECTRIC REGULATOR CORP., 314 Pearl St., Norwalk, Conn. A new line of VF controls is made up of compact, inexpensive, integrated single packages for the precise regulation of both voltage and fre-

. . . You'll find the Type and Size Fuse you need

• • • IN THE COMPLETE LINE OF BUSS AND FUSETRON FUSES

The following is only a partial listing. The complete BUSS line of fuses includes dual-element (slow blowing), renewable and one time types — in sizes from 1/500 ampere up . . . plus a companion line of fuse clips, blocks and holders.

BUSS AGX FAST ACTING FUSES

1/4 x 1 in. Glass tube 1/500 to 2 amp.



BUSS IBM SIGNAL ACTIVATING FUSES

1/4 x 1 1/4 inch. Silverplated pin pops out when fuse is blown and activates signal or alarm.



FUSETRON MDL FUSES

1/4 x 1 1/4 inch. Dual-element — slow blowing type 1/100 to 30 amp.



BUSS ABC CERAMIC TUBE FUSES

1/4 x 1 1/4 inch. High interrupting capacity fuses 1/4 to 30 amp



BUSS GJV PIG TAIL FUSES

1/8 to 6 amp. Solder into circuit wires.

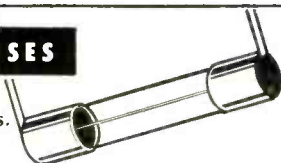

BUSS SFE STANDARD FUSES

Fuses of different amperages are different lengths — to make it impossible to insert too large a size.

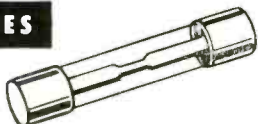

FUSETRON FNM FIBRE TUBE FUSES

13/32 x 1 1/2 inch. Dual-element — slow blowing type.



FUSETRON TYPE N and TYPE C FUSES and FUSEHOLDERS

Especially suitable for protection of TV

Ears on fuses match slots in holder.

Marking on fuse and fuseholder in direct view.

Safeguard against use of wrong size and type of fuse.

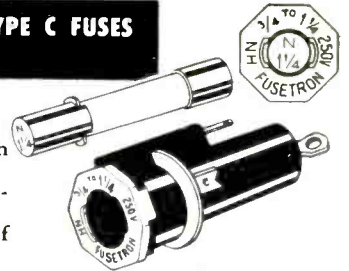

BUSS KLM HIGH INTERRUPTING CAPACITY FUSES

13/32 x 1 1/2 inch. Capable of safely interrupting 68,000 amps.



FUSETRON ACK CLAMP TYPE FUSES

20 to 300 amp., Dual-element type.

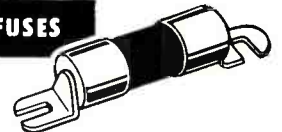

BUSS ACO AIRCRAFT FUSES

Mechanical Indicating — Limiter type 1 to 75 amp.



BUSS Series HJ and HK Non-Indicating FUSEHOLDERS

Panel mounted for 1/4 x 1 inch and 1/4 x 1 1/4 in. fuses.



BUSS Series HJ and HK Lamp Indicating FUSEHOLDERS

Panel mounted for 1/4 x 1 inch and 1/4 x 1 1/4 inch fuses.



BUSS No. 4051 ONE-PIECE CLIP and TERMINAL

Solder type terminal for 1/4 inch fuses.



BUSS No. 4409 FUSE BLOCKS

Small Base, solder type Side Terminals.



BUSS No. 4512 FUSE BLOCKS

Full Base, Screw type Terminals.

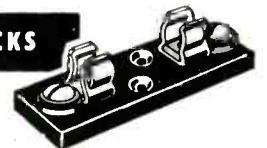

For more detailed information to help you select fuses and fuseholders to meet your electrical protection needs . . . Write for bulletin SFB.

Or tell us your problem and let our Fuse Engineers assist you in getting the protection you require.

BUSSMANN MFG. CO.
Div. McGraw Elec. Co.
University at Jefferson
St. Louis 7, Mo.



Makers of a complete line of fuses for home, farm, commercial, electronic and industrial use.

ELRC 1155

BALLANTINE Model 300

STILL THE FINEST IN
ELECTRONIC VOLTMETERS

Featuring a Logarithmic
Voltage Scale and
Uniform Decibel Scale

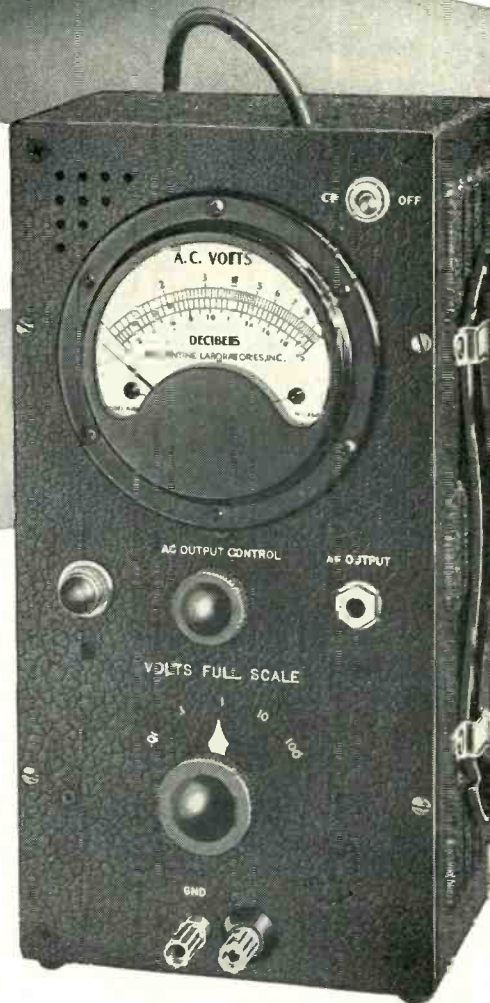

PRICE \$210.

VOLTAGE RANGE001v to 100v
 FREQUENCY RANGE 10 cps to 150 kc
 ACCURACY 2% ENTIRE RANGE
 INPUT IMPEDANCE ½ meg shunted by 30 uuf

- Stability insured by the exclusive use of wire-wound resistors in the attenuator and feedback network.
- Same accuracy of reading at ALL points on the logarithmic voltage scale and linear decibel scale.
- Only ONE voltage scale to read with decade range switching.
- No "turn-over" discrepancy on unsymmetrical waves.
- Accessories available to extend the range to 20 μ v and to 42,500 volts.
- Available Precision Shunt Resistors convert voltmeter to microammeter covering range from 1 microampere to 10 amperes.
- Provides 70 DB amplifier flat within 1 DB from 10 cps to 150 kc.

For further information on this and other Ballantine instruments
write for our new catalog.

BALLANTINE LABORATORIES, INC.



100 FANNY ROAD, BOONTON, NEW JERSEY

NEW PRODUCTS

(continued)

quency of motor-alternator sets and inverters. Presently available in two models, VF-60 for 60-cycle outputs and VF-400 for 400 cycle, the control permits conversion from any d-c source voltage to any a-c output voltage, within the ratings of the controlled machine. Units can be built for any power frequency. Standard units regulate both output voltage and frequency to within ± 2 percent. Special models which control voltage and frequency to within $\pm \frac{1}{2}$ percent, are available for military and other exacting applications. The control permits operation of a-c equipment on vehicles, airplanes, railroads, ships and in remote locations with the reliability that is expected from public utilities lines.

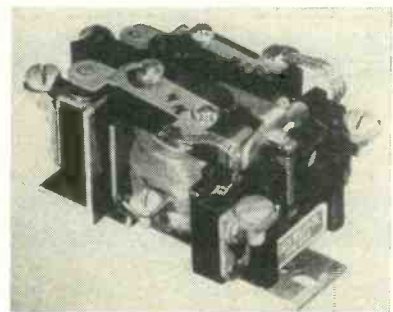

TWO-POLE RELAY for industrial application

LEACH CORP., Leach Relay Division, 5915 Avalon Blvd., Los Angeles 3, Calif. Small size, quiet operation, low coil power and screw terminal connections for simple installation are the advantages of a new 2-pole single-throw relay for motor starting and industrial control of refrigeration and heating equipment. Designed for normally open operation, the new relay is designated the 9194. Motor load ratings are for 1½ hp at 115 v a-c and 3 hp at 230 v a-c. Maximum contact load ratings are for 20 amperes at either 115 or 230 v a-c, single phase and 114 amperes locked rotor at 230 v a-c.

SWEEP GENERATORS

display 845 to 1,950 mc

APPLIED RESEARCH, INC., 163-07 Depot Rd., Flushing, N. Y., has an-

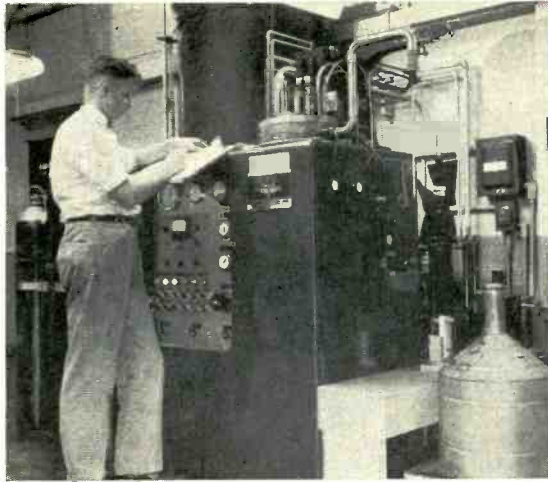

LOW TEMPERATURE

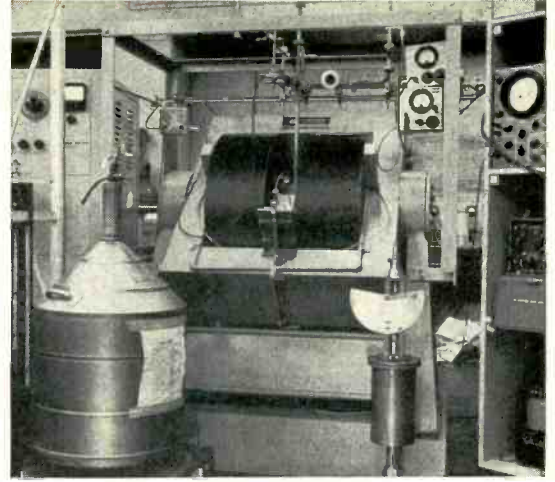

SPIN RESONANCE

ENGINEERS, PHYSICISTS, CHEMISTS

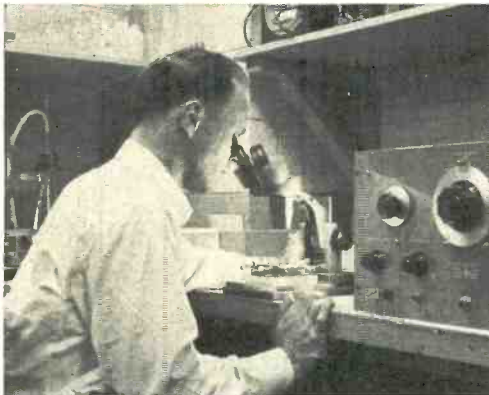

TRANSISTORS

Zenith wants to talk to you about:

- Solid State Physics
- Transistors
- Circuits for Color & Monochrome Television and Radio
- New Types of Vacuum Tubes
- Radio & TV Receiver Design
- Subscription TV (Phonevision)
- Ceramic Engineering (High Dielectric, Piezoelectric)
- Patents
- Industrial Engineering (Automation)

Modern Air-Conditioned Laboratories
 Attractive Profit Sharing and Insurance Plans
 Outer Chicago Location with Opportunity for Suburban Living
 and Graduate Study
 Non-Classified Work—Publication Encouraged

Since 1919 Zenith has manufactured radios for home use and is one of the country's oldest companies continuously in this field. It is today a leading manufacturer of quality television sets and hearing aids. Continuity of management, a record of pioneer technical developments and a reputation for quality products are important factors for you to consider. Zenith's consistent, steady growth and unusually low engineering turnover rate indicate a desirable combination of opportunity and stability.



SYSTEMS ENGINEERING

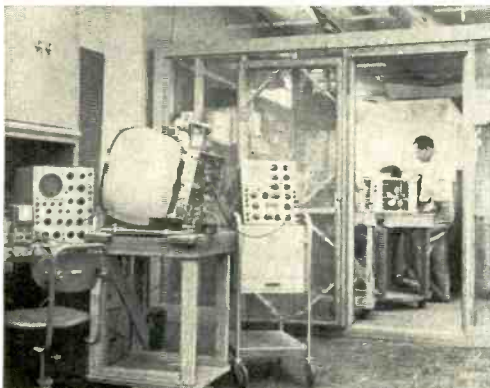

TELEVISION RECEIVER DESIGN

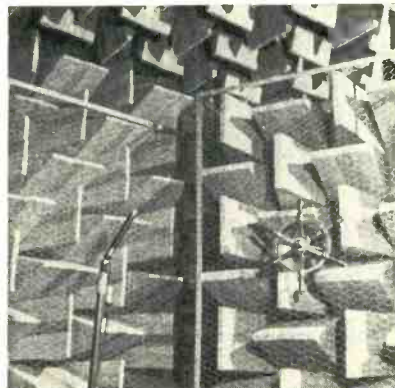

ACOUSTICS

For an appointment, write to
 G. E. GUSTAFSON
 Vice President, Engineering
 Zenith Radio Corporation
 6001 Dickens Avenue, Chicago 39, Illinois

ZENITH
 RADIO CORPORATION



FLEXIBLE but RUGGED

Technicraft Flexible Waveguides offer more electrical and mechanical advantages in combination than other flexible waveguides on the market. For instance the Technicraft Type "V" is the only flexible waveguide that will bend, twist, extend or compress, and shear simultaneously. The Technicraft Type "S" is not only RF leakage-free, but it is the ONLY SEAMLESS flexible waveguide made. Available in Beryllium Copper. Technicraft's Type "L" has a very low VSWR, attenuation and is also capable of carrying higher power than any other flexible waveguide of the same cross sectional size.

TECHNICRAFT LABORATORIES

INCORPORATED

1550 THOMASTON RD. • THOMASTON, CONNECTICUT

Designers and Manufacturers of Rigid and Flexible Waveguide Assemblies, Microwave Test Plumbing and Components, Waveguide Systems.

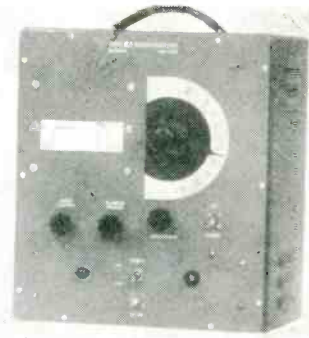

nounced the new type HFS broadband sweep generators. Model 1319 simultaneously displays the frequency range of 1,350 to 1,950 mc; and model 813, the range of 845 to 1,375 mc. This makes possible rapid design, alignment and test of systems and components within the L-band frequency. Through the use of these generators the development and use of broadband multiple-tuned resonant circuits are made possible. The selectivities which can only be obtained from quadruple, sextuple and even deca-tuple tuned circuits now become available.

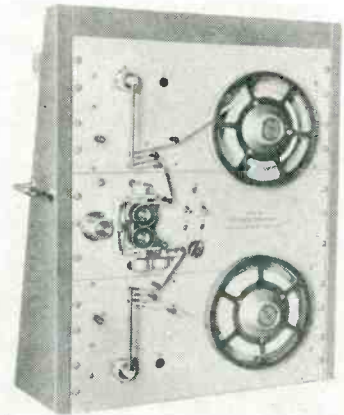

TAPE READER

is a high-speed machine

POTTER INSTRUMENT CO., INC., 115 Cutter Mill Road, Great Neck, N. Y. With start and stop times of 5 milliseconds and tape speeds up to 60 ips, the model 903 perforated tape handler offers character readout up to 600 per sec. It will actually stop on the stop character at speeds of 150 and 300 characters per sec and on the character following the stop character at rates of 600 characters per sec. This greatly increases the efficiency of the machine. Various models are avail-

General Plate

COMPOSITE CONTACTS

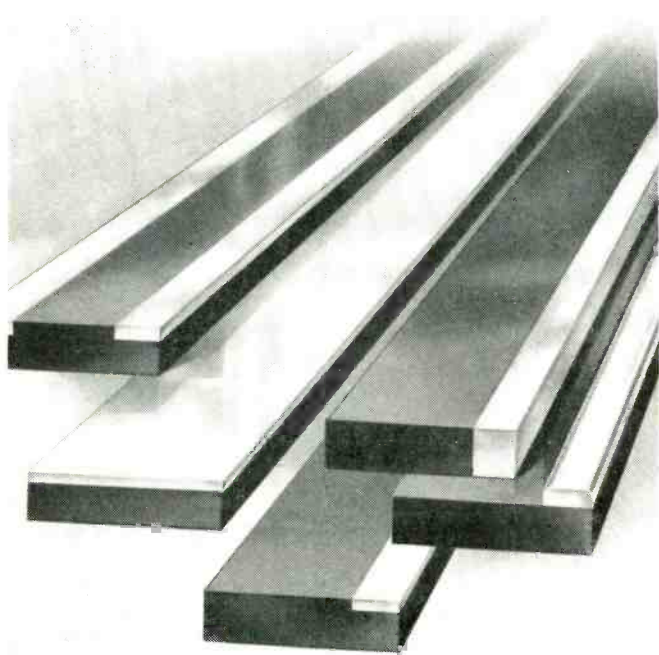

COMPOSITE STOCK

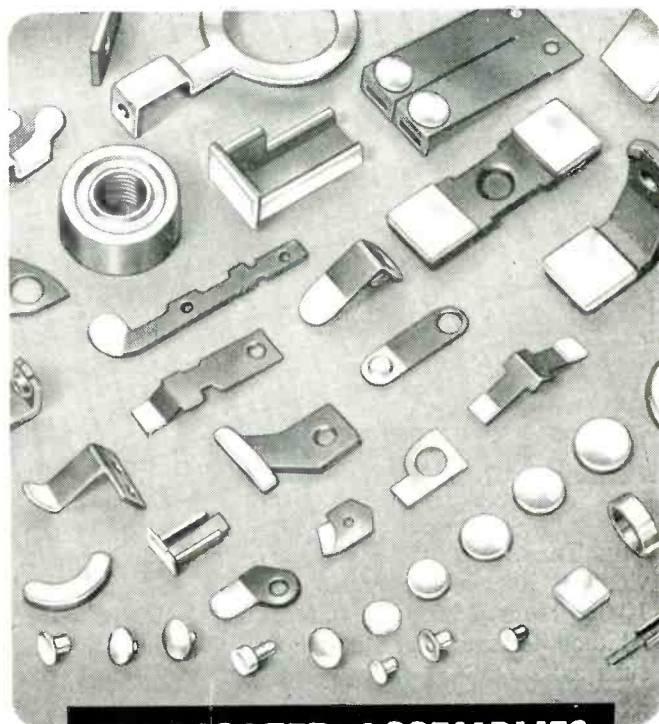

FABRICATED ASSEMBLIES

Composite Contact Material that meets your requirements Composite Contact Assemblies that cut your costs!

There are many advantages for using General Plate composite contact materials, processes and facilities. Among the more important are better performance, longer operating life and lower fabricating costs.

But that's not all — here at General Plate you have a single source that can supply your contact requirements be it composite raw stock, contacts or complete assemblies. General Plate stock and contacts are available in a wide range of alloys designed to meet your specific requirements.

General Plate Composite Contact Materials make it possible to manufacture complete contact assemblies to close tolerances by single blanking

and forming operations. Compare this to other methods whereby the contacts and supporting members are fabricated separately and then assembled by brazing, welding or staking methods.

By letting General Plate fabricate your complete contact assemblies, you will save money, time and trouble . . . needless equipment cost and problems of scrap disposal are eliminated . . . contacts and/or contact assemblies made to your exact specifications are shipped to you ready for installation.

Write for complete information and Catalog PR700.

**You can profit by using
General Plate Composite Metals!**

**METALS & CONTROLS CORPORATION
GENERAL PLATE DIVISION
311 FOREST STREET, ATTLEBORO, MASS.**

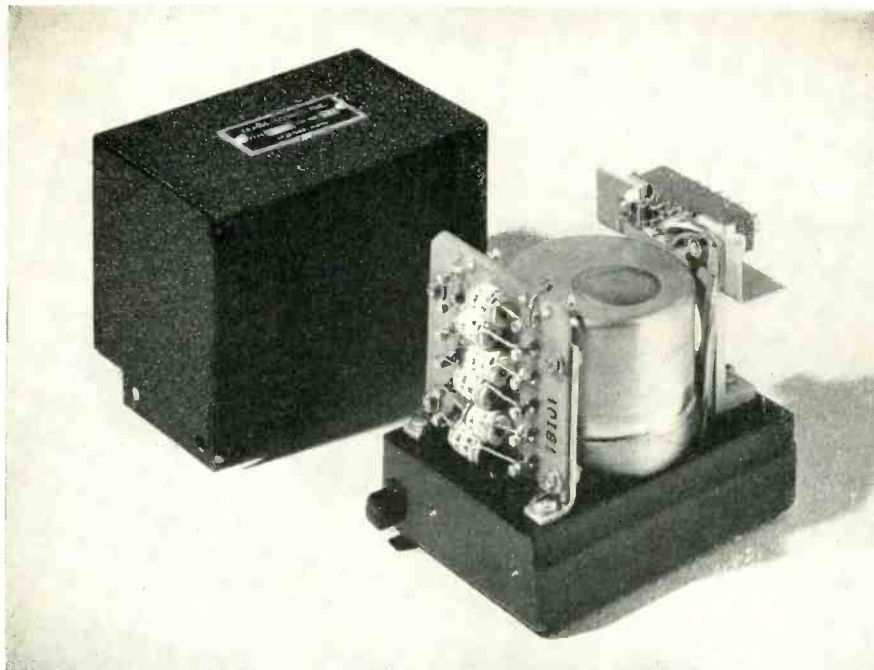

Shown with Cover off — approximately 1/2 Size

ALTITUDE POTENTIOMETER

THE TRANS-SONICS® Type 1067 Pressure Operated Potentiometer provides a linear voltage ratio versus altitude output. Input impedance is 10,000 ohms. Maximum voltages up to 100 volts can be obtained so this Altitude Potentiometer can be used without amplifiers in applications such as:

- a) Varying servo loop gain as a function of altitude.
- b) Modulating the subcarrier oscillator of telemetering systems.
- c) Recording and indicating altitude remotely.

Accuracy and interchangeability including effects of nonlinearity, hysteresis, stiction, and friction are within a band ± 0.01 VR of the nominal line. Voltage Ratio is 0.55 at -400 ft. and varies linearly with altitude to 1.0 at 50,000 ft. This *linear-with-altitude* relationship is obtained from the *linear-with-pressure* mechanism by shaping the electrical output with additional resistors across tapped sections of the potentiometer winding.

The Type 1067 Pressure Transmitter is an example of an instrument which TRANS-SONICS, INC. designed for a specific application and produces in quantity and on schedule. Similar instruments, but having a *linear-with-pressure* voltage ratio output, are offered for applications such as telemetering, recording, and experimental development. These units have potentiometer coils with multiple taps connected through a convenient, accessible terminal board to a connector.

Write for Multi-Tap Potentiometer Bulletin
"For Transducers See Trans-Sonics"

Trans-Sonics, Inc.

5 FOREST STREET • BEDFORD, MASSACHUSETTS

able to handle tape widths from $\frac{1}{8}$ in. to 1 in. and 5 to 8 channel tape for nearly every conceivable tape handling operation. Readout head is of simple photo-diode construction. Reel size on the tape handler is $10\frac{1}{2}$ in. and capacity is 1,000 ft.



GYRO TESTER

indicates drift rate fast

CEDAR ENGINEERING INC., 5806 W. 36th St., Minneapolis 16, Minn. The gyro tester is designed to speed up drift rate measurements of HIG-3, HIG-4, HIG-5, HIG-6 and similar devices employing a torque generator input and a signal generator output. The new circuit eliminates time-consuming rate-table techniques. The unit calibrates torques up to 100 dyne cm. It gives a continuous indication of drift rate that can be recorded for long term drift measurements. Tests can also be made for mass unbalance, reaction torque of torque generator, or signal generator, and earth rate measurements.

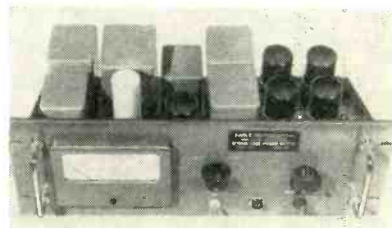

POWER SUPPLY

for strain gage systems

EAGLE INSTRUMENTS, INC., Van Nuys, Calif., has available a new power supply unit that is useful in most strain gage systems as a

an Ampex can keep your
accountant happy too!

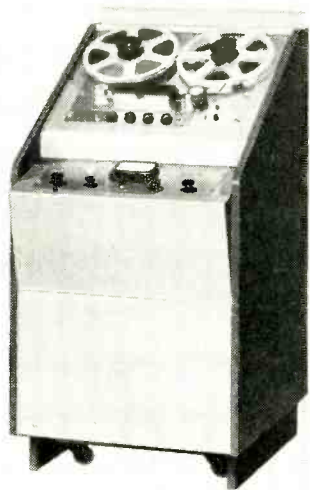

**it can cost less per hour
than any other recorder
you can buy**

A few cents per hour is all it costs in the long run . . . because year after year an Ampex continues to perform within original specifications (18,000 known hours of service in one actual instance). Inevitably it requires fewer adjustments and parts replacements than machines of lesser quality. And because an Ampex is the recorder that everyone wants, it maintains the highest percentage of its original value. For lasting economy, buy the best — buy Ampex. For further information, write Dept. E-2290

SIGNATURE
OF
PERFECTION
IN
SOUND

AMPEX
CORPORATION

934 Charter Street, Redwood City, California

**PRECISION
ATTENUATION
TO 3000 mc!**

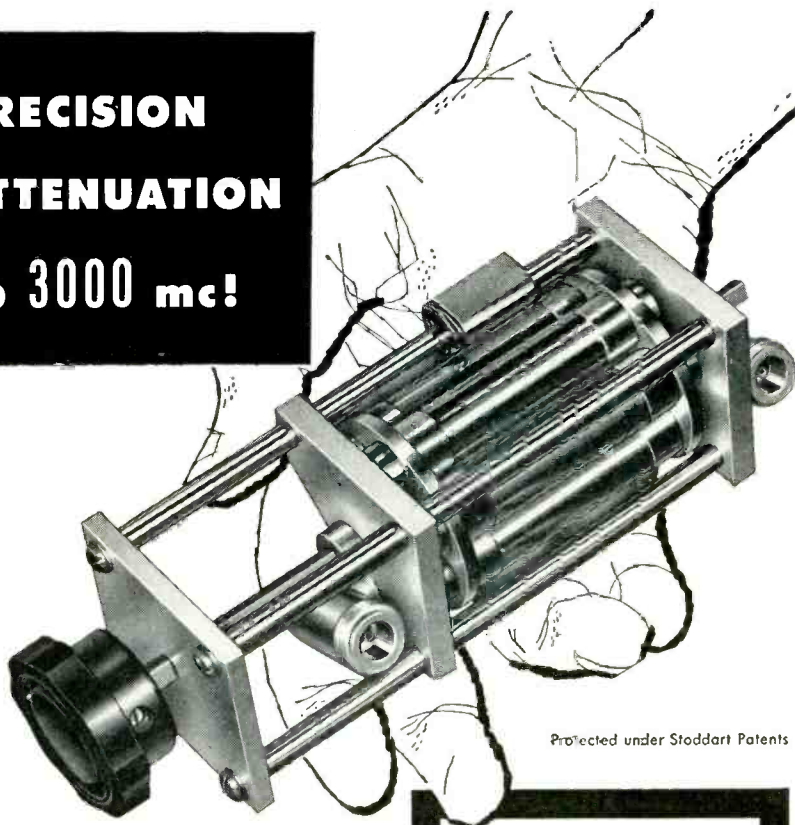

Protected under Stoddart Patents

six-position
TURRET ATTENUATOR
featuring **PULL-TURN-PUSH** action

FREQUENCY RANGE: dc to 3000 mc.
CHARACTERISTIC IMPEDANCE: 50 ohms.
CONNECTORS: Type "N" Coaxial female fittings each end.
AVAILABLE ATTENUATION: Any value from 1 db to 60 db.
VSWR: 1.2 max., dc to 3000 mc/s, values from 10 to 60 db. As value decreases below 10 db, VSWR increases to not over 1.5.
ACCURACY: ± 0.5 db.
POWER RATING: One watt sine wave power dissipation.

**SINGLE "IN-THE-LINE" ATTENUATOR PADS
and 50 ohm COAXIAL TERMINATIONS**

This new group of pads and terminations features the popular Type C and Type N connectors, and permits any conceivable combination of the two styles. For example, the two connector types, either male or female, can be mounted on the same attenuator pad, with or without flanges, so that it may serve as an adapter as well as an attenuator. Frequency range, impedance, attenuation, VSWR, accuracy and power rating are as designated above. Send for free bulletin entitled "Measurement of RF Attenuation."

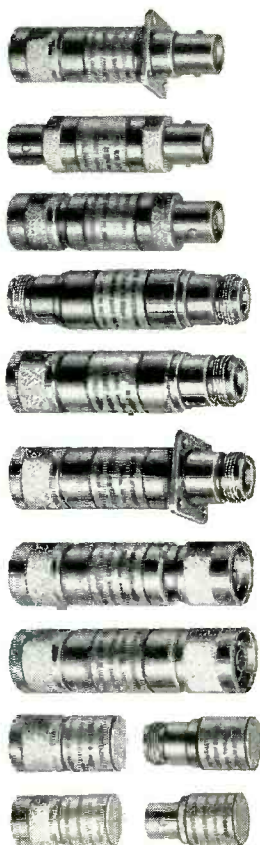

STODDART AIRCRAFT RADIO Co., Inc.
6644-A Santa Monica Blvd., Hollywood 38, California - Hollywood 4-9294

direct replacement of a battery. Drop-off of output voltage is eliminated as well as battery charging and maintenance. Complete isolation from the input line results in less than 1-mv ripple from either output side to ground. It features magnetic circuitry, resulting in maximum reliability and long life. All components are in hermetically sealed cans with only the interconnecting wiring exposed. Output of the strain gage power supply is 5 to 15 v in two ranges at 0 to 1 ampere, continuously adjustable within 0.1 percent. Ripple is less than 0.05 percent; regulation, ± 0.1 percent.

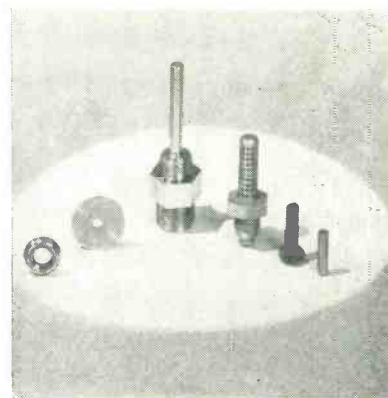

**TEMPERATURE PROBES
in varied configurations**

ARNOUX CORP., Box 34628, Los Angeles, Calif. High resistance (20,000 ohms) temperature probes, when used with TME bridge network, provide 5-v output signals (without amplification) for as little as 150 deg temperature change. Probes are available in varied configurations for measuring fluid, surface, structure, air, hydraulic line, cylinder head and subminiature component temperatures.

**H-V POWER SUPPLIES
in six compact models**

MICROTIME LABORATORIES, 7247 Atoll Ave., N. Hollywood, Calif., announces two new series of 60, 100 and 200 kv power supplies in six compact models. Input is 115 v a-c; maximum continuous current output is 1 ma. The HV series units permit, through use of a suitable



You can't beat
this *New* relay for

CONTACT RELIABILITY!

The miniature relays used for guided missiles may function many times . . . or only once. But performance must be perfect!

To meet this "super" reliability demand, our engineers went to work on our 4PDT gold-alloy-contact, flange-mounted relay which was already tops in its field. They came up with a special design that will take more vibration and shock than any miniature relay we have ever offered. It has withstood vibration tests over 2000 cycles at 25G's and shock tests in excess of 50G's . . . and still maintained continuous contact reliability!

To meet particular customer requirements each relay can be subjected to thousands of operations under his exact circuit conditions. Only those relays which pass this test would be selected for shipment. This same run-in service is available to you where utmost reliability is necessary.



This addition to our standard UNION Miniature Relays is available in 4PDT only, with either gold alloy or palladium contacts. It meets or exceeds all requirements of MIL-R-5757.

For complete information on this relay (Piece No. 326638), call our nearest sales representative listed below, or write for literature.

GENERAL APPARATUS SALES

UNION SWITCH & SIGNAL

Division of Westinghouse Air Brake Company

Pittsburgh 18



Pennsylvania

NEW YORK, IVanhoe 3-2424 (Hempstead) BOSTON (Ashland) TRinity 2-4485 BALTIMORE, VALley 5-3431 ST. LOUIS, JEFFerson 5-7300
CHICAGO, LONgbeach 1-3042 LONDON, OHIO, LONdon 1555 LOS ANGELES, VANDyke 8731

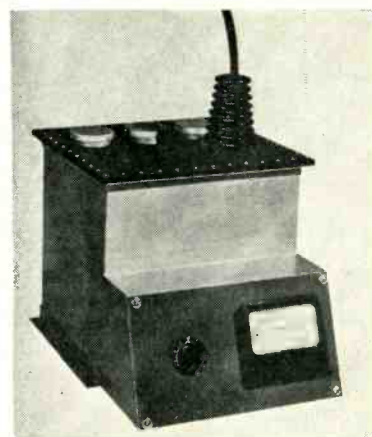

variable transformer, a-c primary voltage of the h-v transformer to be varied independently of the filament voltage. Powerstat and associated meter are available, mounted on the unit if desired. HVA series consist of a basic h-v supply and a separate a-c control, each housed in a completely enclosed cabinet. Reversible polarity, 0-230 v a-c, and additional current output are available on special units. Illustrated is the HV-60 with Powerstat.



SOLDER BRAZER operates in small areas

TARTAK ELECTRONICS, 2979 No. Ontario St., Burbank, Calif. Model SP-102 Hi-Temp solder brazer has been designed for simple operation. The unit brazes Formvar or enamel-covered wire without costly prestripping or precleaning. The joints made by this brazer are stronger and will stand up longer than the wire itself. The crucible cannot crack even if allowed to cool without emptying the unit, thus increasing the operation life of the unit. The brazer has a crucible life in excess of 300 hr. The unit incorporates a switch for temperature control on the front panel

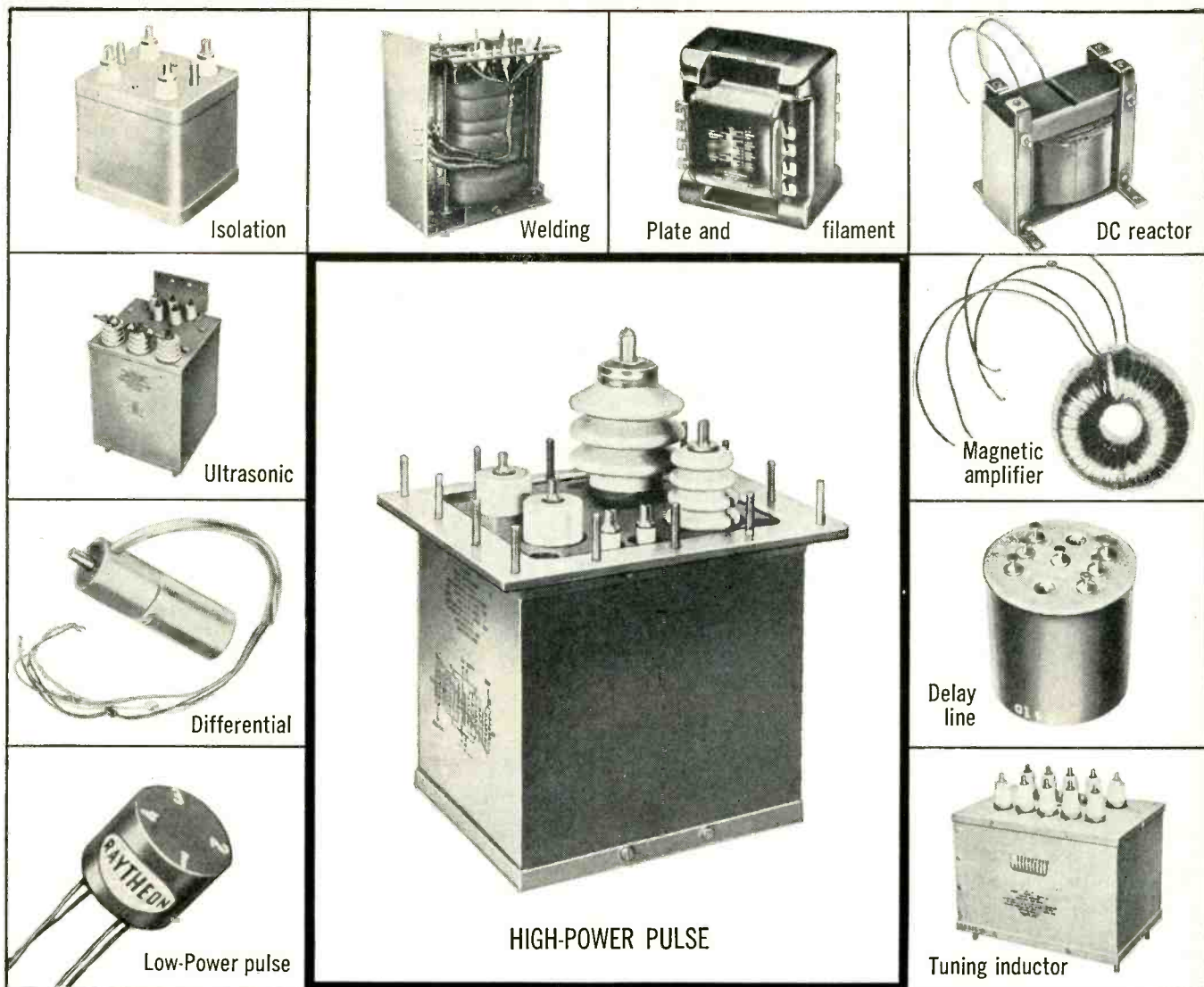

RAYTHEON TRANSFORMERS designed for your specialized applications

CUSTOM DESIGN

To meet your need for specialized electronic signal and power range transformers, Raytheon offers exceptional standard transformers and custom design facilities. An unusually large and widely experienced engineering staff is at your service to design and develop transformers that best fit your particular applications.

PERSONAL SUPERVISION

Available to you are the resources of Raytheon's entire transformer engineering staff. Yet in order to best satisfy your needs, design, development and production of your transformers are turned over to an individual Raytheon engineer who sees your job through from start to finish.

PRODUCTION AND TESTING

All types of winding, core processing, impregnation and baking equipment are available for model making or full production runs. Raytheon also offers complete facilities for testing.

25 YEARS' EXPERIENCE

Raytheon has successfully custom engineered over 30,000 transformer designs and millions have been produced. Proof of Raytheon quality is this fact: *in 25 years less than 1/4 of one percent of all Raytheon transformers have been returned from the field for any reason.*

For full information write Department 6120.
Request catalog 4-100

RAYTHEON MANUFACTURING COMPANY

Equipment Marketing Division
Dept. 6120, Waltham 54, Mass.



Excellence in Electronics

Condense and Save!

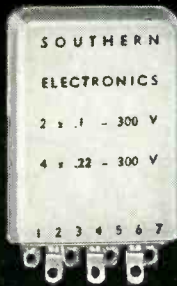

*plastic condenser block capacitors
save you Space, Labor, Money!*

Multiple capacitors in one block! Now you can install one capacitor case and use 125% less space as before —at a saving in labor costs of up to 300%.

Available with polystyrene or MYLAR* dielectric to tolerances as close as 1%.

NOW!

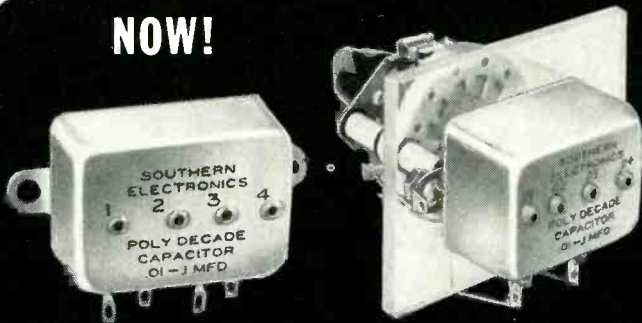

Precision Decade Capacitors

with attached rotary switch or completely boxed.

CAPACITANCE
... FROM .001
TO 10 M F D

CHECK THESE OUTSTANDING FEATURES:

- STANDARD VOLTAGE RATING... 200 V. D. C.
- VERY HIGH INSULATION RESISTANCE
- LOW DISSIPATION FACTOR
- LOW DIELECTRIC ABSORPTION
- SMALL SIZES

Available with polystyrene or MYLAR* dielectric to tolerances as low as 1%.

*DuPont T. M.

Join America's leading electronic equipment manufacturers in specifying Southern Electronics' precision polystyrene capacitors for your most exacting requirements. Write for complete catalog today!

SOUTHERN ELECTRONICS



Corporation

239 West Orange Grove Ave., Burbank, Calif.

enabling the production lines to have four convenient ranges of heat: 1,200 F, 1,350 F, 1,500 F and 1,650 F. The brazer has been constructed to operate in small areas along the assembly lines, thus eliminating the need for multipots, which take up valuable production space.



TUBE RETAINER mounted to chassis by rivets

P. R. MALLORY & Co., INC., 3029 E. Washington St., Indianapolis 6, Ind., has designed a simple but effective tube retainer to prevent parallel-mounted flat-press or button base subminiature tubes from working loose from their sockets. The tube retainer, mounted to the chassis by rivets, has been silver-plated both to prevent corrosion and to insure good electrical contact with metallic coated tubes. The retainer has been designed for use in all military or civilian electronic equipment using miniaturized circuits where the circuits will be subjected to rugged conditions of shock and vibration. Technical specifications and supplemental data may be obtained by writing the company.

QUANTIZER

adaptable to any shaft

THE AUSTIN Co., 76 Ninth Ave., New York 11, N. Y. A new shaft position quantizer with its control unit provides a standard shaft-position-to-digital converter system. Essentially a simple induction device, the unit has no gears or digitizing commutators. The four standard models of the Quantizer, functioning with the standard control unit, divide one turn of the

America's Most Complete Line of Instrument Calibration Standards!

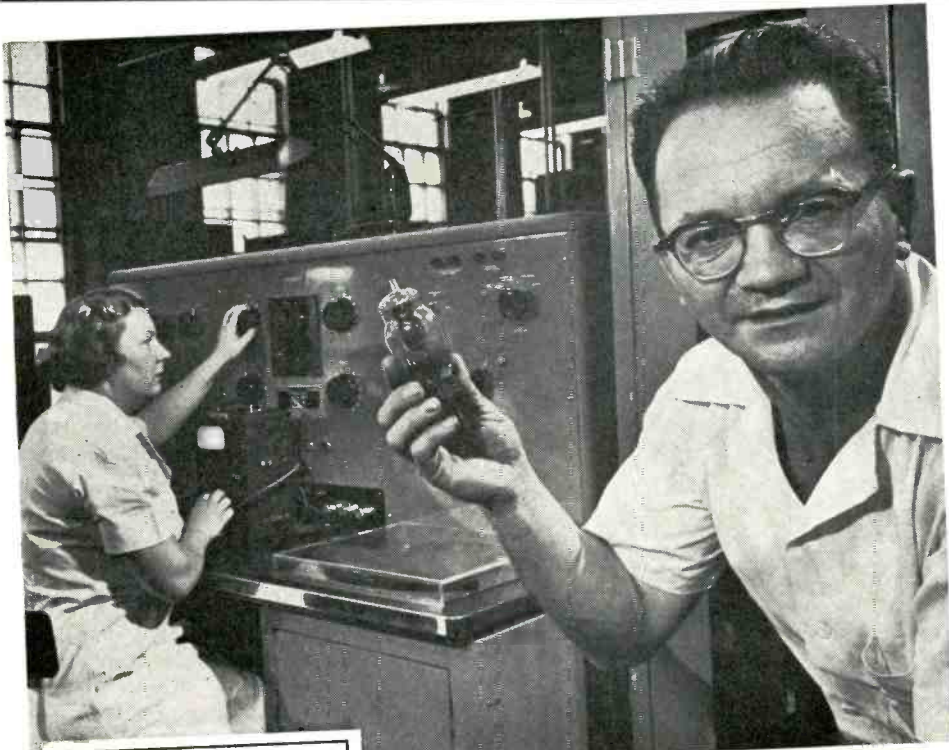

"Simple to Operate..
yet **EXTREMELY ACCURATE"**

FROM ACTUAL EXPERIENCE BY
Test Engineering Activity
RCA TUBE DIVISION
HARRISON, NEW JERSEY

For three years the life test laboratory of the Harrison plant of the RCA Tube Division has been using the RFL Models 262B and 454B Instrument Calibration Standards to periodically check the accuracy of over 2,000 meters employed to measure receiving tube characteristics prior to shipment. Element currents, amplification factor, plate resistance, transconductance, emission, etc., are measured to fine tolerances.

According to Mr. Tomalesky, manager of the laboratory, "both Standards are in operation eight hours a day, five days a week. Only two maintenance calls have been necessary in three years. The 0.1% accuracy of Model 262B satisfies our requirement for DC meter standardizing. These two Standards have eliminated the problems associated with previous methods."

The advantage gained by in-plant calibration of electrical instruments using these console type Standards, which encompass the full range of testing instruments, under controlled laboratory conditions, goes beyond mere convenience. Their ease of operation, consistent calibration and high accuracy over wide current and voltage ranges are impossible to duplicate using individual testing equipment which must be moved from job to job throughout a manufacturing plant.

In addition to accuracy, each RFL Standard has many features which make rapid calibration procedure possible. Where many instruments must be tested, it can be demonstrated that an appreciable cost saving over older calibration methods will soon result.

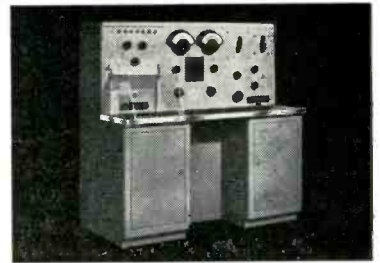

Model 260C

Calibrates DC electrical measuring instruments to direct reading accuracies of 0.5% (0.25% using calibration charts) through voltages ranging from 1 millivolt to 1500 volts and currents ranging from 1 microampere to 150 amperes.
Net price \$8,975.00 f.o.b. Boonton.



Model 261B

Calibrates all types of AC meters to direct reading accuracies of 0.5% (0.25% using calibration charts) over frequency range of 50 to 1600 cps. Current range from 1.5 milliamperes to 200 amperes; voltage range from 75 millivolts to 1500 volts. Output of electronic power oscillator has less than 5% total harmonic content at 60 cycles.
Net price \$9,250.00 f.o.b. Boonton.

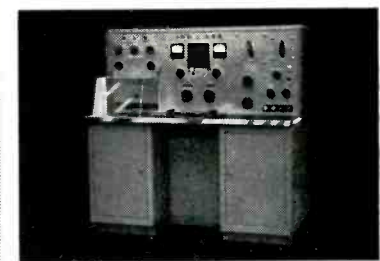

Model 262B

Calibrates DC electrical measuring instruments to direct reading accuracies of 0.1% (0.05% using calibration charts) through voltages ranging from 1 millivolt to 1500 volts and currents ranging from 1 microampere to 150 amperes.
Net price \$14,300.00 f.o.b. Boonton.

Write for technical data and application information.



Radio Frequency
LABORATORIES, INC.
Boonton 3, New Jersey, U.S.A.

DESIGNERS AND MANUFACTURERS OF ELECTRICAL EQUIPMENT SINCE 1922

Radio Frequency Laboratories, Inc.
Boonton, New Jersey

Please send me complete information on all Instrument Calibration Standards.

Name _____ Title _____
Company _____ Phone _____
Address _____
City _____ State _____

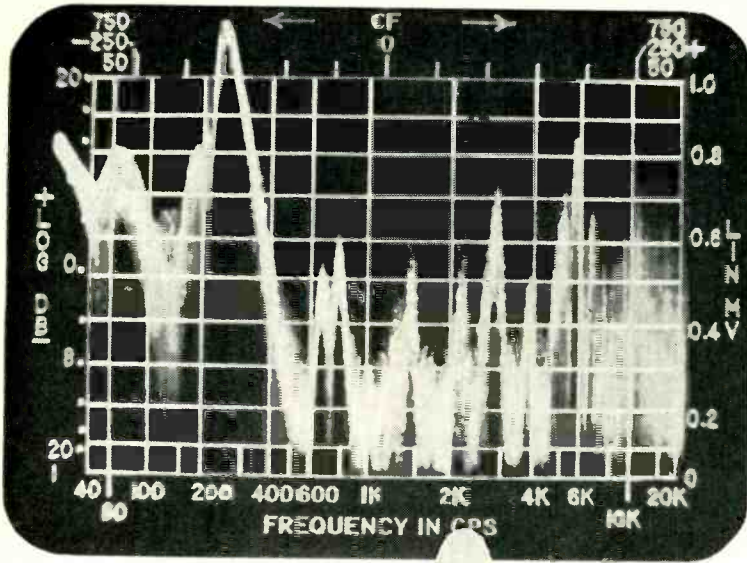

Analysis of vibration resonances of a small motor. Actual analysis time 10 seconds.

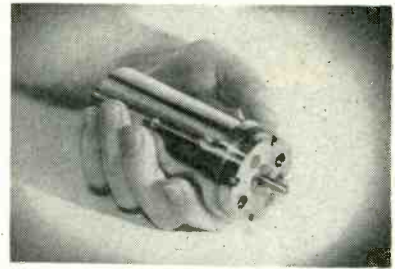

data shaft into any one of many possible divisions which range from 320 to 4,096 parts. The total count is accurate to ± 1 count for any position of the shaft and is guaranteed whether the data shaft is stationary or turning at up to 240 rpm. An external command pulse initiates a shaft position reading. The output count is an exact measure of the shaft position at the instant of the command pulse. Electronic converter systems providing various output resolutions using the small size quantizer, and larger sized quantizers for resolutions above 4,096 parts per turn, are available.

how to accurately analyze SOUNDS, VIBRATIONS, AUDIO WAVEFORMS at high speeds (as much as 360 times faster, in fact)

with PANORAMIC Sonic Analyzer LP-1



Model LP-1 showing edge-lit reticule and camera mount bezel.

Whatever your problem... sound, vibration, or general spectrum analysis in the laboratory or on the production line, you can reduce engineering and production test costs with the Panoramc Sonic Analyzer LP-1.

In only one second, the LP-1 automatically visualizes on a Cathode Ray Tube the frequency and magnitude of waveform components between 40 and 20,000 cps.

Join the many top-flight manufacturing, research and development activities which have increased their efficiency through the use of instruments made by Panoramc, the leader.

- Operates with microphones, vibration pickups and other transducers.
- Presents data graphically permitting rapid, direct readings of frequency and voltage.
- Data can be easily photographed or recorded.
- Linear and log voltage calibration.
- Simple operation.

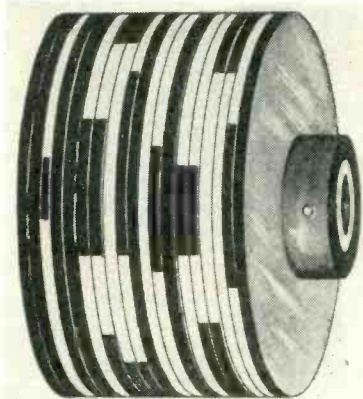

COMMUTATOR in drum form

ELECTRO-MINIATURES CORP., 205 Lafayette St., New York 12, N. Y., has developed a new drum type switching commutator. It gives dependable trouble-free performance in the smallest possible space. All switching combinations are attainable. Other applications are frequency multiplication and division. These drums are particularly well suited to cascade operation. Solid, precision made, precious metal or alloy segments and a wide choice of plastics allow extensive ranges of operating temperature, insure long shelf life and give stable operation



Fairchild Polaroid Oscilloscope Camera Model F-296

Designed for use with Panoramc instruments incorporating a 5" flat face CRT, Model F-296 provides full size prints of panoramc presentations. No photographic skill required.



WRITE FOR COMPLETE DETAILS, PRICES AND DELIVERY TODAY

10 South Second Ave., Mount Vernon, N. Y. Phone: MOUNT VERNON 4-3970

in service. Simple registration techniques make possible highly accurate angular resolution as well as exceptionally small segments. Size and weight for airborne and military applications are minimal.

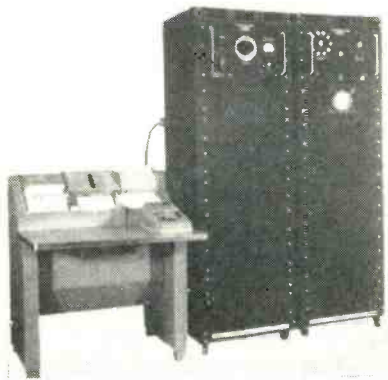

DATA RECORDER
for gyro rate tables

EPSCO, INC., 588 Commonwealth Ave., Boston 15, Mass. System No. 177 automatic data recorder for gyro rate tables makes use of magnetic techniques to punch automatically on IBM cards data arriving asynchronously from as many as 10 separate sources. Data consists of time interval measurements to an accuracy of 1/10,000 of a sidereal minute. In addition, dates, identification numbers, shaft positions and temperature are automatically recorded on the IBM cards. Special provision is made for measuring the average time interval between pairs of pulses in order to compensate for asymmetry in the rate table.

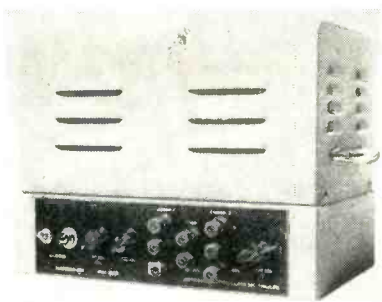

ELECTRONIC LOAD
measures internal impedance

AMERICAN ELECTRONIC LABORATORIES, INC., 641 Arch St., Philadelphia 6, Pa., has available an elec-

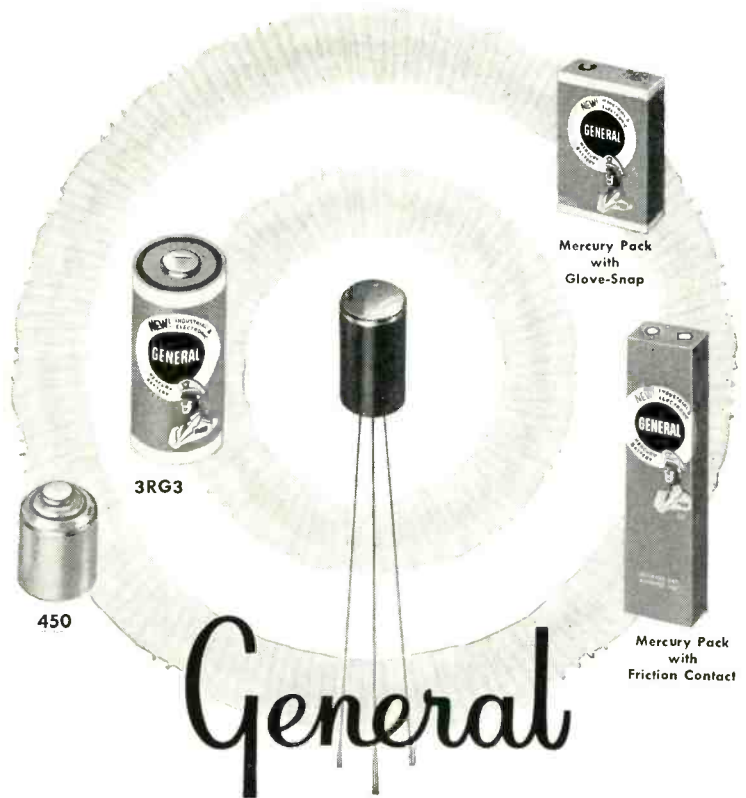

mercury batteries can add extra dependability to your products

TODAY, many products are providing greater dependability, thanks to the unique qualities offered by General Mercury Batteries.

General Mercury Batteries have excellent shelf and operating life, have a high ratio of energy to size and they provide a constant source of voltage till exhausted. A nickel-plated steel can makes them resistant to the effects of humidity and corrosive atmospheres. General Mercury Batteries are available in "power packs" in an unlimited number of series, parallel or series-parallel combinations. These packs are made up of individual cells joined together by General's exclusive surge-weld process. This method assures a safe, sound, lifetime connection.

These qualities are being used in many products with transistor or electronic circuits like Geiger counters, tachometers, guided missiles, pocket radios, hearing aids, and numerous test devices.

If you need dependable power in small space, you might find that our experience in developing mercury cells and "power packs" can be of valuable assistance. It's at your disposal. Just write and tell us how we can help. We will be glad to send you free data.

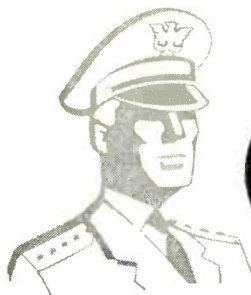

13000 ATHENS AVE., CLEVELAND 7, OHIO
BOulevard 2-0030

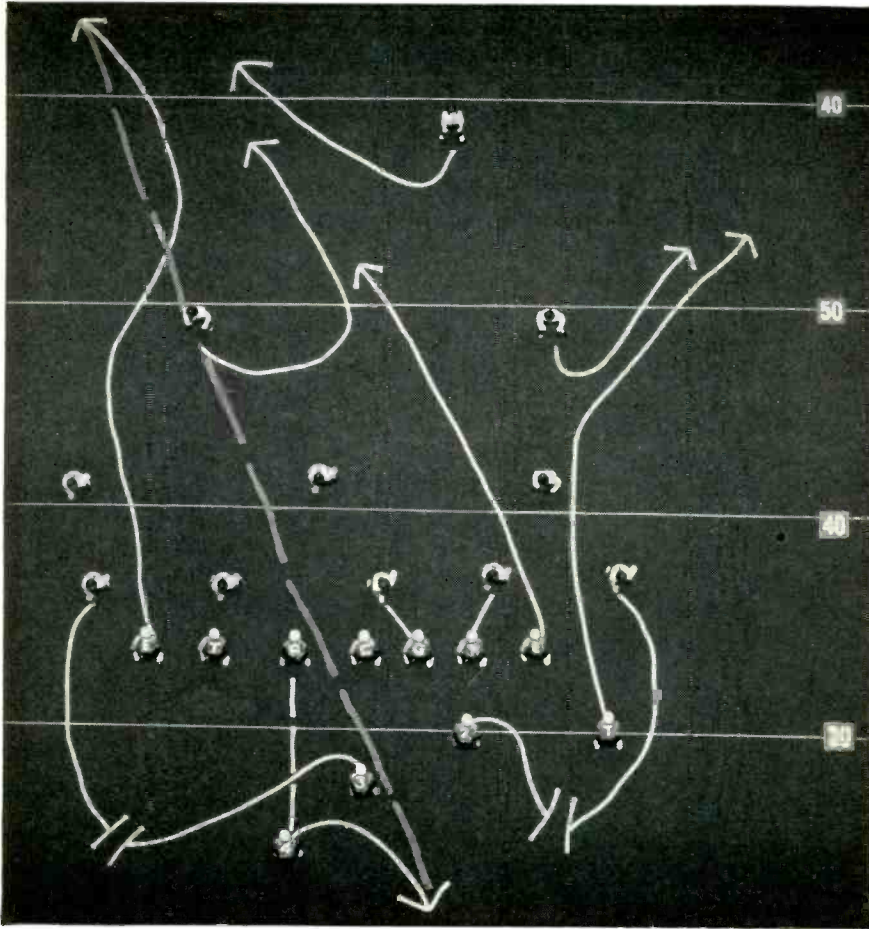

aerial attack

Q: What has *this* to do with the aircraft industry — and you?

A: It may have plenty to do with both. Here's how:

Football teams are judged by scoring ability in top competition—teamwork, form, ability, strategy, class. So, too, are aircraft companies.

Martin has created one of the finest engineering teams in the whole world of aviation. And under the new Martin concept of design and development by team operation, every engineering problem—from today's experimental contract to the frontier problems of the future—is the target for a coordinated "aerial attack" by a top-flight team of specialists.

Result: Martin's team operation technique has opened up important opportunities for young creative engineers.

Contact J. M. Hollyday, Dept. E-11, The Martin Company, Baltimore 3, Maryland.

MARTIN
BALTIMORE

tronic load for both static and dynamic measurements on d-c power supplies. It provides a direct and convenient method of measuring the internal impedance of a regulated power supply as a function of frequency and determining the range of load over which the regulation is effective. The instrument contains 2 individual channels with independent static load adjustments. Channels may be interconnected for a total average power range of 150 w. A wide range of currents may be drawn at various applied voltages so long as the maximum ratings of tubes are not exceeded. Provision is made for both external and internal modulation of load tubes for dynamic regulation checks. Also provided is a 1-ohm resistor to allow a voltage output proportional to load current to be obtained for observing voltage current waveforms on an oscilloscope.

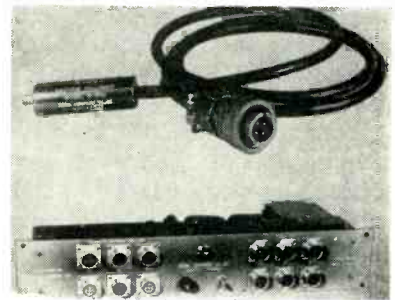

CATHODE FOLLOWER for crystal transducer

SIGNAL EQUIPMENT CO., INC., 2706 Third Ave., Seattle 1, Wash. The Sonic model S-650 is an impedance matching cathode follower with unusually high input impedance and resistance to most adverse environmental conditions. Its input impedance is over 200 megohms; gain is 0.95 ± 1 percent from 2 to 20,000 cps; and its vibration sensitivity is less than $20 \mu\text{v}$ per g. The unit will withstand vibration of ± 10 g and shock-excitation of 30 g of 12 milliseconds duration. The case is filled with casting resin to make the unit impervious to dust, moisture, altitude or mechanical failure. The S-650 was designed for use with barium-titanate accelerometers. A specially designed 6-channel power supply with low ripple and d-c heater source is

available in both rack and cabinet models for operation of these cathode followers or other devices with similar power requirements.

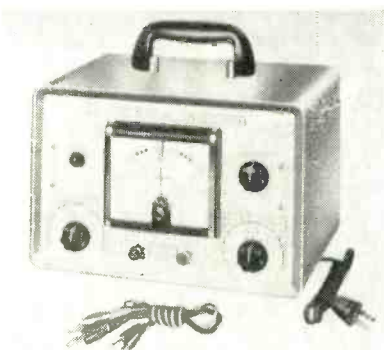

TESTING UNIT shows capacitor leakage

SIMPSON ELECTRIC CO., 5200 W. Kinzie St., Chicago 44, Ill., has developed the model 383 in-circuit capacitor leakage tester. It shows the presence or absence of leakage in virtually all paper, mica, or ceramic capacitors while connected in the circuit, eliminating disconnecting and resoldering. The tester checks capacitors ranging from 1 $\mu\mu\text{f}$ to 0.25 μf for leakage from a few ohms to hundreds of megohms, and also detects breakdowns, shorts and intermittents. Checking is done at full rated working voltage, right in the circuit. Capacitors under test can be shunted by circuit resistance which is much lower (1 percent or less) than the value of the leakage resistance.

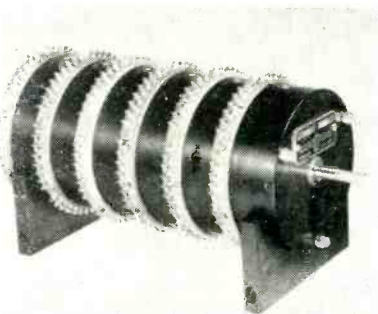

SAMPLING SWITCH low-level type

GENERAL DEVICES, INC., P.O. Box 253, Princeton, N. J., has a new low level sampling switch, 6 pole, 540 contacts. Each contact plate has 90 contacts and employs semi-

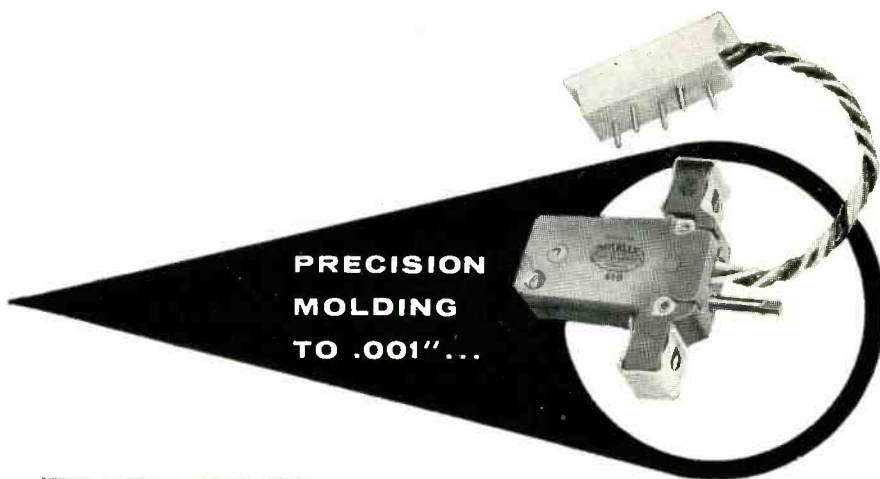

PRECISION
MOLDING
TO .001" ...

IBM

CHOOSES

MYCALEX[®] 410

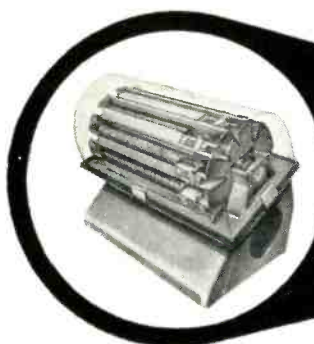

ABSOLUTE
DIMENSIONAL
STABILITY...

IBM chooses Mycalex 410 glass-bonded mica for 200 critical parts in each drum assembly of the new Type 650 Magnetic Drum Data Processing Machine because this combination of precision molding and dimensional stability is essential for the accurate reading, under varying conditions, of up to 20,000 digits of stored data.

And these other properties too, have helped make Mycalex world-famous as "the most nearly perfect insulation":

- ▶ withstands extreme operating temperatures
- ▶ offers total arc resistance
- ▶ possesses low loss and power factors
- ▶ is moldable with tight inserts

Write today for information concerning your particular insulation problem. Address inquiries to General Offices and Plant: Dept. 114
P.O. Box 311, Clifton, New Jersey.

World's largest manufacturer
of glass-bonded mica products

**MYCALEX
CORPORATION
OF AMERICA**

Executive offices:
30 Rockefeller Plaza
New York 20, N. Y.

SINCE 1919
MYCALEX
THE INSULATOR

"do-it-yourself" is OK...
but not for microwave!



Sometimes it just isn't economical to 'do-it-yourself'. In setting up microwave frequency standards, for example, matching individual components can be an awful chore... and the end results are seldom satisfactory.

Narda's new Microwave Frequency Standard provides wavemeter calibration at frequencies from 2400 to 40,000 mc within .001% accuracy. The basic package consists of a temperature-stabilized crystal oscillator, with multiplication for stabilized outputs at 100, 500 and 1500 mc. Harmonic beats for wavemeter calibrations at higher frequencies are provided by mixing the Standard's output with that of a swept klystron. Specially designed waveguide assemblies in all sizes are available for the Standard. And it's all built with Narda's attention to detail, assuring long, trouble-free service.

Narda can supply all your microwave and uhf instrumentation. Our experience and complete line can save you time, trouble and expense.

Write us today for our complete catalog, prices and the name of our representative who can serve you.



the **narda** corporation

160 HERRICKS RD., MINEOLA, N. Y. • PIONEER 6-4650

COMPLETE INSTRUMENTATION FOR MICROWAVE AND UHF

molded construction for greater dimensional stability and superior performance. Constant force Perma-Brushes are utilized for more dependable and longer service free life. Convenient solder type terminals or wire leads with plugs are available on request. The switch features dynamic phasing and each pole can be individually adjusted in phase relative to the other poles, while the switch is operating with a special design adjustment wrench. Dynamic contact resistance is approximately 1 ohm average. Measurements are $7\frac{1}{8}$ in. long, $3\frac{3}{8}$ in. diameter.

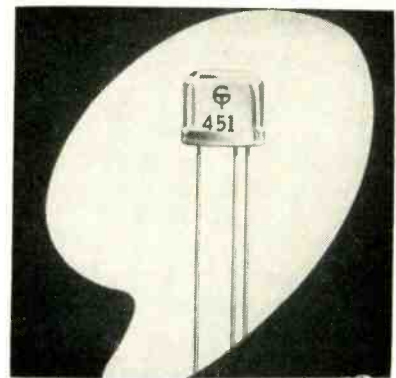

H-F TRANSISTORS are double sealed

GENERAL TRANSISTOR CORP., Jamaica, N. Y., is now delivering its new h-f GT-760 series of transistors. The new series is designed for h-f operation as r-f and i-f amplifiers in broadcast receivers and as switches for high-speed computer application. The GT-760, GT-761 and GT-762 with respective alpha cutoff frequencies of 5 mc, 10 mc and 20 mc are double sealed—encapsulated in plastic and hermetically sealed in a can.

FILLER MATERIAL used in casting resins

FERRO CORP., Cleveland, Ohio, is producing an inorganic filler material known as Kanamite. It is being used in casting resins in some classified electronic equipment as a core filler in plastic dies and as a strength additive in foamed plastics. In addition to being an inorganic displacement filler in plastics, it also ads considerably to the

flowability. In proper percentage usage can contribute additional strength, and shrinkage in curing can also be reduced. Kanamite is the trade mark for unicellular, spheridized clay particles fired at around 3,000 F in a process developed several years ago by the Kanium Corp. at the Armour Research Foundation.

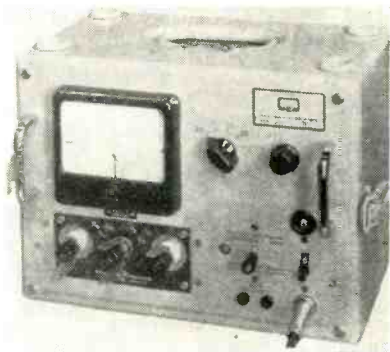

TOLERANCE INDICATOR for testing components

FEDERAL TELEPHONE AND RADIO Co., 100 Kingsland Road, Clifton, N. J., has introduced a tolerance indicator designed for rapid production testing of resistors, capacitors and inductors by comparison with an external standard. Direct readings in percent are given on a 4-in. meter with four tolerance ranges providing sensitivities as high as 2.5 percent full scale. The wide range of measurements include 10 ohm to 1 megohm, 10 μf to 1 μf , and 100 μh to 2 mh with an accuracy of ± 5 percent of full scale. With a separate accessory meter, sensitivity of 0.01 percent per division is available, equivalent to 0.5 percent full scale.

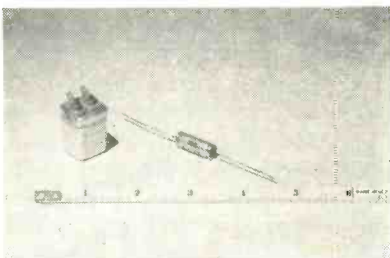

TANTALYTICS in 2 high-temperature lines

GENERAL ELECTRIC Co., Schenectady 5, N. Y. Two new types of 125 C

Solar specials can solve your design problems

We'll build electro-ceramic components and assemblies for any requirement

When chassis space is too small, or ambients too high for standard components—call Solar. Ditto when you need whole circuits condensed into limited-size areas...or many components integrated into a single unit. Solar takes your problem and winds up with the needed special components or sub-assemblies.

Equipped for the job

The Solar research laboratory is amply staffed with personnel experienced in designing specials. Engineering facilities are complete—we even do our own ceramic compounding, which gives us the flexibility to design exactly what you need—or adapt to it. Extensive production facilities, recently expanded, enable us to manufacture your specials in the shortest time possible. No matter how complex your problem, send it in. We'll work with you—in confidence.

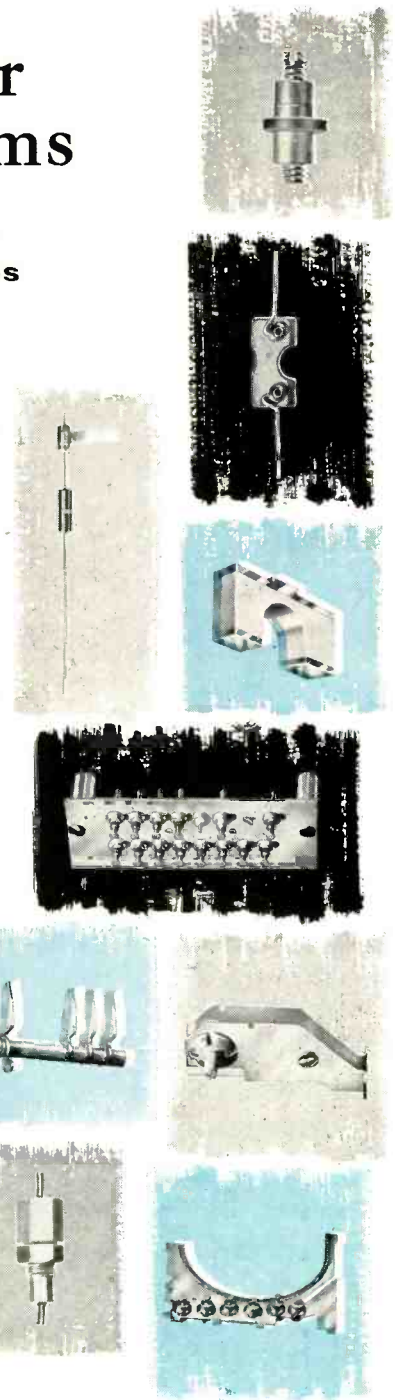
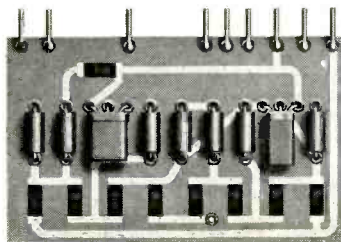

"QUALITY ALWAYS"

SOLAR MANUFACTURING CORP.
New York, N. Y.



SALES OFFICES: 46th & Seville, Los Angeles 58, Calif.
4000 W. North Ave., Chicago 39, Ill.

CERAMIC CAPACITORS • PRINTED NETWORKS • PIEZO CERAMICS

LARGE CAPACITY IN SMALL SPACE



Fansteel TANTALUM Capacitors

The tantalum oxide film employed in Fansteel Capacitors is the most stable dielectric, chemically and electrically, yet discovered. Fansteel Tantalum Capacitors have a practically unlimited life, either in use or on the shelf; have a maximum d-c leakage of only 0.000008 ampere; and stable characteristics are unchanged over a wide temperature range.

Fansteel offers Tantalum Capacitors in 87 sizes and ratings. A partial listing is shown here. All sizes are available from stock.

Send for
bulletin 6.100

CATALOG NUMBER	CAPACITY MFD*	WORKING VOLTAGE D-C	MAXIMUM D-C LEAKAGES
PP30B6A1	30	6	1.0
PP25B8A1	25	8	1.0
PP20B10A1	20	10	1.0
PP15B15A1	15	15	1.5
PP10B25A1	10	25	2.0
PP8B30A1	8	30	2.0
PP5B50A1	5	50	3.0
PP4B60A1	4	60	3.0
PP3.5B75A1	3.5	75	3.0
PP2B100A1	2	100	3.0
PP1.75B125A1	1.75	125	3.0
PP140B6A1	140	6	2.0
PP100B10A1	100	10	2.0
PP70B15A1	70	15	3.0
PP40B30A1	40	30	4.0
PP25B50A1	25	50	5.0
PP20B60A1	20	60	5.0
PP15B75A1	15	75	6.0
PP11B100C1	11	100	7.0
PP9B125C1	9	125	7.0
PP325B6A1	325	6	3.0
PP250B10A1	250	10	3.0
PP175B15A1	175	15	4.0

*— 15% +20% at 120 cps, 25°C
§ Microamperes, at 25°C

tantalum capacitors have been announced. The rectangular case types range in rating from 36 μf at 100 v d-c to 220 μf at 25 v. The cylindrical case types range from 36 μf at 100 v to 160 μf at 10 v. Designed to operate in the high ambient temperatures produced in jet engines and guided missiles, the new units will perform for 1,000 hr at 125 C without losing more than 20 percent of initial 25 C capacitance. The rectangular units may be mounted in the same chassis space as the cylindrical, slung-type units. Construction features tantalum foil and a nonacid electrolyte in both polar and non-polar types. The cylindrical units feature a double casing and a double bushing seal, to check the evaporation of the electrolyte. The cylindrical units are similar in shape to the 85 C line, but slightly larger, and can be mounted with the same type of clamps. The rectangular units are best for bus-bar wiring applications, and the cylindrical for point-to-point wiring.

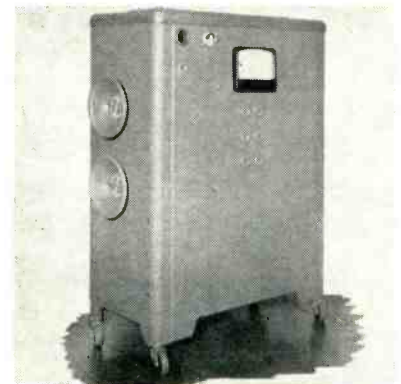

LAB POWER SUPPLY is a portable unit

THE STRONG ELECTRIC CORP., 142 City Park Ave., Toledo 2, Ohio, has developed a portable laboratory power supply transformer unit for convenient, on-the-spot availability of any desired output voltage. With 3-phase, 230-250 v, 60-cycle a-c input, the unit has two output ranges: 211-640 v, 31 amperes, in 10-v steps; and 100-295 v, 66 amperes in 4-v steps. Adjustment is by 8 fine steps and 8 coarse steps with overlap. Taps are changed on 3 phases simultaneously. It is designed for continuous duty at the



FANSTEEL METALLURGICAL CORPORATION

North Chicago, Illinois, U.S.A.

C556A

TANTALUM CAPACITORS... DEPENDABLE SINCE 1930

rated output, and includes a heavy duty 115-v cooling fan. Parallel 100-ampere capacity output jacks are provided.



MICROAMMETERS with 4-in. dial scale

BURTON-ROGER Co., 42 Carleton St., Cambridge 42, Mass. The new Hoyt No. 647 d-c and No. 648 a-c microammeters for industrial panel installations feature smoothly finished black Bakelite cases which are not affected by industrial fumes or high temperatures. Meters are available with provision for bottom illumination and have standard 4 in. by $3\frac{9}{16}$ in. mounting stud dimensions. The No. 647 d-c meter has the standard Hoyt high-torque, D'Arsonval movement; the No. 648 a-c meter, an air damped, jeweled movement with cross arm balance.

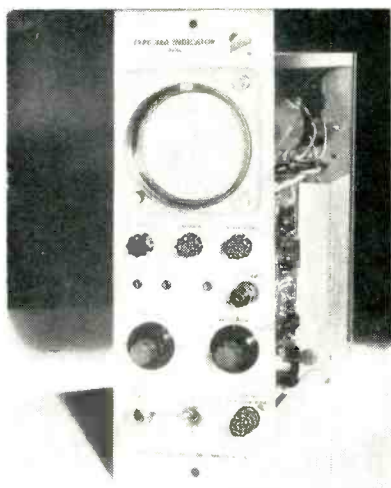

INDICATOR replaces bulkier scopes

TEKTRONIX, INC., P. O. Box 831, Portland 7, Oregon. Type 360 indicator contains a 3-in. flat-faced crt,

LARGE OUTPUT IN SMALL SPACE

Fansteel

HIGH-TEMP SELENIUM Rectifiers

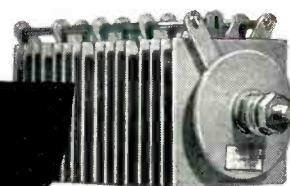

CATALOG NUMBER	CIRCUIT	INPUT A-C VOLTS	CONT. D-C OUTPUT AT 100°C	
			VOLTS	AMPS.
TADL35L	1-35-1-H	455	402	0.004 ⁽¹⁾
TEUH315 ⁽²⁾	2-8-1-D	132	254	0.020 ⁽¹⁾
TBU100L	1-100-1-H	2600	1090	0.020
TEB328L ⁽³⁾	2-11-1-D	363	297	0.150
TEW066L	4-4-1-B	132	108	0.180
TEC070L	4-5-1-B	165	135	0.300
TEX034L	4-1-3-B	33	27.8	1.59
TED200LN	2-13-1-C-N	214	-175	0.600
TBY060L	4-3-1-B	78	62.7	1.0
TBY060L	4-3-1-B	41	62.7	1.0 ⁽¹⁾
TEEW334L ⁽⁴⁾	2-7-1-D	231	295	2.3 ⁽²⁾
TEFW332L ⁽⁴⁾	2-13-1-D	429	548	4.6 ⁽²⁾
TBG084L	2-1-1-C	13	10.4	5.2
TET050L	4-2-1-B	66	53.9	4.6
TEP314L ⁽³⁾	2-7-2-D	231	189	14.0
TER020L	6-3-1-B	66	79.5	12.9 ⁽²⁾
TER034L	4-1-3-B	33	27.8	25.8
TBR008L	6-1-4-B	26	32.5	51.6 ⁽²⁾

⁽¹⁾ Capacitive Load. Ratings unmarked are for resistive or inductive loads.
⁽²⁾ Hermetically Sealed.
⁽³⁾ Two stacks required.
⁽⁴⁾ Three stacks required.
⁽⁵⁾ Resistive, inductive or capacitive load.

Operating at 100°C (212°F) Fansteel High Temperature Rectifiers deliver full rated power output, continuously, with no derating whatever. At temperatures up to 150°C (302°F), only moderate derating is necessary.

Fansteel High Temperature Rectifiers are available in all standard cell sizes and all standard circuit arrangements and with all standard protective finishes — moisture resistant, fungus resistant and a salt-spray resistant finish that meets MIL specifications. The table indicates a partial list of over 100,000 available types.

Send for
bulletin 6.401

FANSTEEL METALLURGICAL CORPORATION

North Chicago, Illinois, U.S.A.



E558A

DEPENDABLE RECTIFIERS SINCE 1924

Stupakoff

ALUMINA CERAMICS

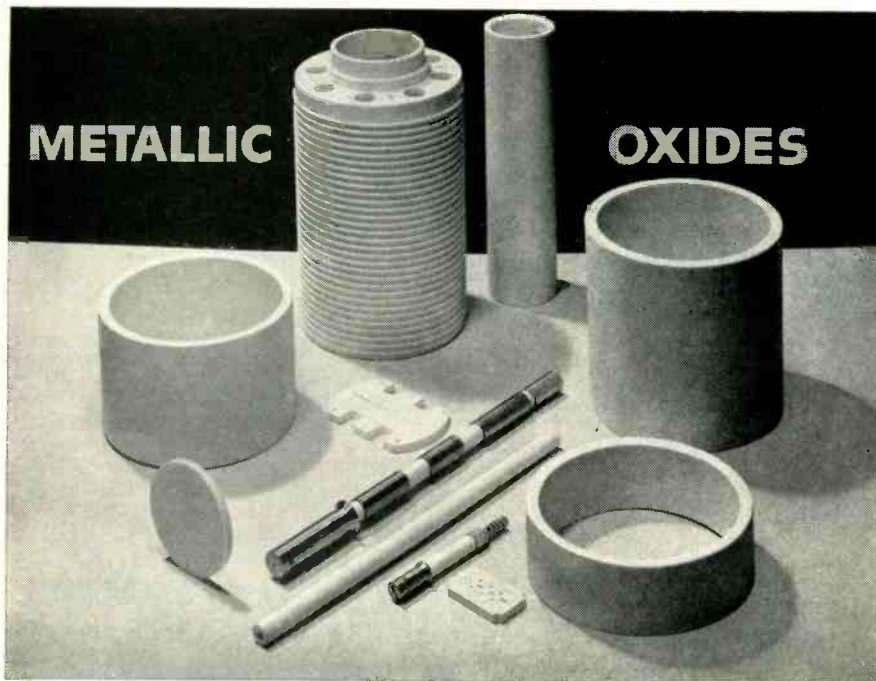

These man-made "sapphires" provide

EXTRA strength . . .

EXTRA hardness . . .

EXTRA precision . . .

For mechanical, electrical and electronic applications, Stupakoff Alumina Ceramics provide highly valuable characteristics. Because they are exceptionally hard, parts made of this material serve well under conditions of abrasion and wear. Because of the material's high strength, it finds many applications where its resistance to pressure, shock and impact adds to the life and service of an assembly. Because Stupakoff has the equipment and skill to mass-produce alumina parts with dimensions held to close tolerances, Stupakoff precision ceramics assemble readily and function correctly.

Parts may be simple or complex, ground or machined, plain, metallized or assembled. Our research and engineering facilities are available to assist in the design of your parts.

Stupakoff

Division of The **CARBORUNDUM** Company

LATROBE, PENNSYLVANIA

Write Dept. E.

NEW PRODUCTS

(continued)

accelerating-voltage supply, vertical amplifier with a sensitivity of 0.05 v per division, and a calibrated vertical attenuator. It can take the place of a bulkier oscilloscope in single monitoring applications, or several can be used along with other instruments as building blocks in complex sequence-control and monitoring systems. Features include: d-c to 500 kc vertical-amplifier passband; four calibrated sensitivities from 50 mv per division to 50 v per division with 10-to-1 attenuator for continuously variable sensitivities from 50 mv per division to 500 mv per division. Horizontal gain control permits sweep calibration. Weight is 9 lb; price, \$195.

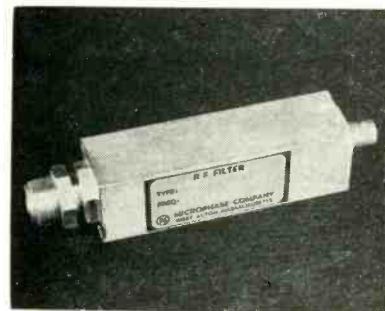

COAXIAL FILTERS

for uhf and microwave use

MICROPHASE CORP., Box 1166, West Acton, Mass., has announced compact, low-pass coaxial filters for use in the uhf and microwave region from 100 to 2,000 mc. Featuring insertion loss less than 1 db, the attenuation of series LS rises to 60 db within 25 percent, and that of series LF within 13 percent of the cutoff frequency. These filters are useful for suppression of harmonics and spurious radiation from transmitters and receivers, and for laboratory measurements. The filters, rated at 100 w, are 3 to 8 in. long, and weigh 5 to 9 oz, dependent upon cutoff frequency. They are resistant to vibration and shock, and can meet the requirements of MIL-E-5400 and MIL-E-5422C. Type N connectors, one male and one female, are normally furnished; other connectors, including types BNC, C, and UHF, can be provided. Standard cutoff frequencies available are 100, 200, 400, 700, 1,000 and 2,000 mc. Other low-pass, as

well as high-pass and band-pass filters, are available with cutoff frequencies from 10 to 10,000 mc.

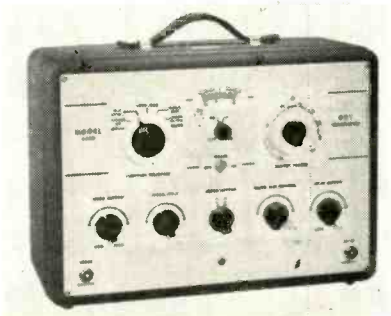

DOT GENERATOR for circuit checking

TRIPLETT ELECTRICAL INSTRUMENT Co., Bluffton, Ohio. Model 3438 dot generator checks video, r-f, i-f, sync and color circuits with modulated r-f (channels 2 to 6) and i-f (20 to 55 mc) outputs available. Horizontal syn pulses (15,750 cycles) and vertical sync pulses (60 cycles) are available for checking sync circuits. Other features include: horizontal bars (480 to 600 cycles) and vertical bars (crystal controlled at 189 kc) for checking linearity on black-and-white and color sets; and cross hatch used to check overall linearity with 11 vertical bars and 8 horizontal bars. A square block will be produced for the cross-hatch pattern. On the equipment white dots of proper size are used to check convergence of color tv sets.

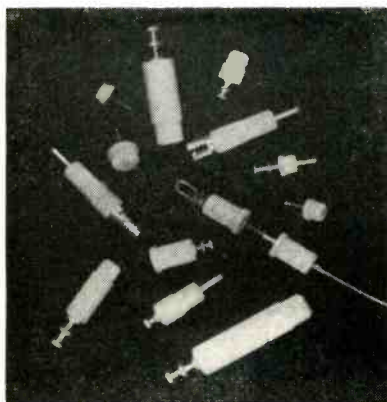

PRESS-FIT TERMINALS simplify assemblies

SEAELECTRO CORP., 186 Union Ave., New Rochelle, N. Y., has developed and manufactured terminals featur-

Stupakoff

CERAMIC MATERIALS

At your fingertips...

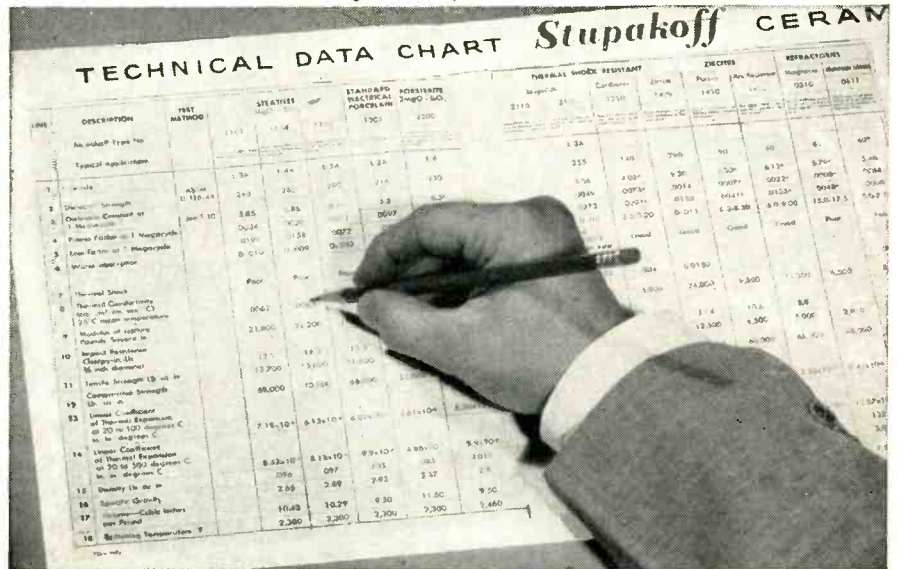

NEW TECHNICAL DATA on Stupakoff CERAMIC MATERIALS

The very latest technical information on a wide range of ceramic materials is given in the new Stupakoff Technical Data Chart. Electrical and physical characteristics and the chemical composition of various grades of the following ceramic materials are included:

- ALUMINA
- PORCELAIN
- ZIRCON
- ALUMINUM SILICATE
- STUPALITH
- ZIRCITE
- STEATITE
- CORDIERITE
- FORSTERITE
- MAGNESIA

Valuable design and application suggestions included in the Stupakoff Data Chart help you engineer your ceramic parts for lowest cost and greatest satisfaction.

Send today for your free copy of the new Stupakoff Data Chart. Arranged for ready reference.

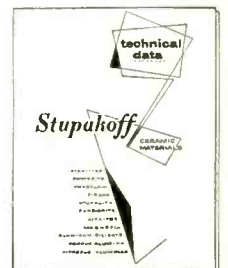

Stupakoff

Write Dept. E

Division of The CARBORUNDUM Company

LATROBE, PENNSYLVANIA

MINNEAPOLIS
Honeywell

Heiland OSCILLOGRAPH

Recording Galvanometers

with higher frequencies
higher sensitivities

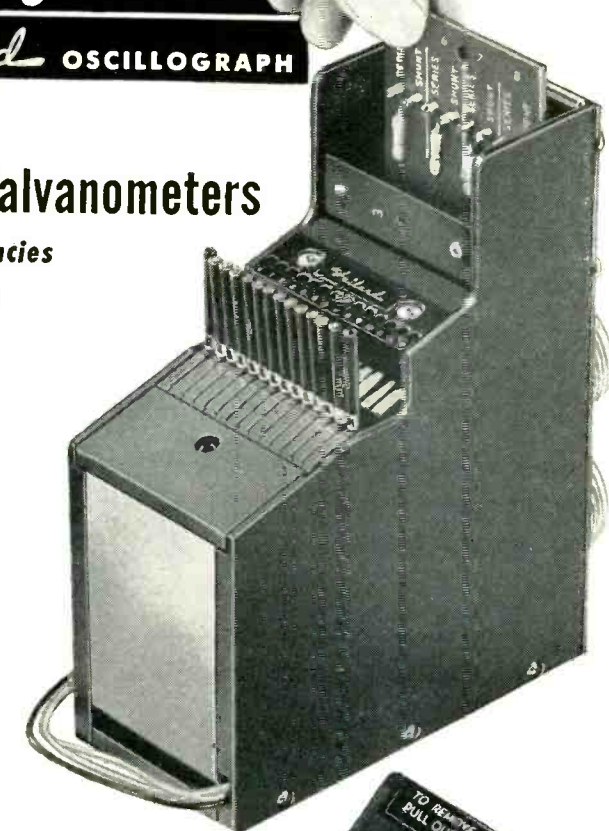

The new Heiland Series 700C Recording Oscillograph gives you an increased number of channels, extended frequency range, greater sensitivities, and operates throughout a broader temperature range because of this new magnet assembly and subminiature galvanometers.

- The series shunt-resistor networks—which with their connectors form a part of the completed magnet assembly—are easy to insert from the operating surface of the oscillograph.
- Galvanometers are available in frequencies as high as 5000 cps, yet they need only 34 milliamperes per inch deflection. The lower frequencies require as little as 4 microamperes per inch deflection.
- For your recording requirements, no matter how complex, select the new Heiland 700C Recording Oscillograph.

For complete details request our bulletin No. 700-CKK

Heiland®



A DIVISION OF MINNEAPOLIS-
HONEYWELL
130 E. 5th Ave., Denver 3, Colo.

ing Teflon insulation for excellent electrical properties particularly at high frequencies. Because of the resiliency of this material, the terminals are simply press-fitted into the chassis or component hole with an inexpensive insertion tool, for a snug, rigid, permanent installation. Press-Fit terminals are especially suited to applications requiring high shock and vibration resistance. Dielectric constant and loss factor are extremely low. Insulating properties favor miniaturization and subminiaturization programs. Sealectro offers stand-offs, feedthroughs and handy connectors for breakaway connections.

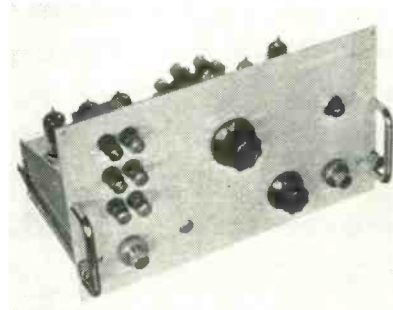

PREAMPLIFIER converts into d-c voltages

SANBORN Co., 195 Massachusetts Ave., Cambridge, Mass. Model 150 Preamplifier converts rms values of a-c and voltage into proportional d-c voltages. Typical performance specifications when used with associated company equipment, are as follows: type of reading, true rms; voltage ranges: 25, 125, 250 v; current ranges: 50, 100, 250, 500 ma, 1 ampere; full-scale deflection: 5 cm; overall tolerance, ± 3 percent of full scale, for frequencies between 50 cycles and 2 kc. It is usable to 4 kc. Rise time is 0.15 sec. Complete specifications and data are available on request.

SCANNING INSTRUMENT for easy operation

ROBERTSHAW-FULTON CONTROLS Co. 2920 North Fourth St., Philadelphia 33, Pa. Checking and controlling various steps in production processes are simplified through the use of the new Fielden electronic scanner, capable of monitor-

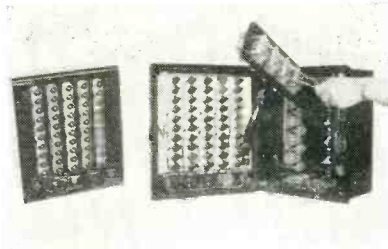

ing up to 25 production points. The scanner may be used in any industrial or lab process to monitor variables including temperature level, flow and pressure. It is designed to check processes at a speed of either 1 point or 5 points a second, and maintains a continuous check on its own accuracy and operation. Further information on the scanner is available without obligation from the Fielden Instrument Division of the company.

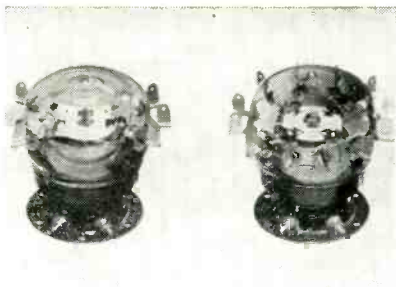

VACUUM RELAYS
multiple pole type

JENNINGS RADIO MFG. CORP., P. O. Box 1278, San Jose, Calif. Multipole vacuum transfer relays are available for switching antennas, pulse networks, and many d-c circuits. Types RM2 (2 pdt) and RM4 (4 pdt) models are provided with removable 24 v d-c actuating coils built into the flanged bases. An efficient magnetic circuit penetrates the vacuum seal by utilizing the different magnetic properties of copper and steel. Vacuum enclosed contacts are rated at 12 kv peak and are capable of continuously carrying 30 mc currents of 10 amperes rms. They can withstand test voltages of 18 kv peak between contact terminals and from the terminals to the base. Contact resistance is only 0.005 ohm and it remains low even when broken under load due to the complete absence of any contaminating materials within the

PANELOC announces a new rotary latch

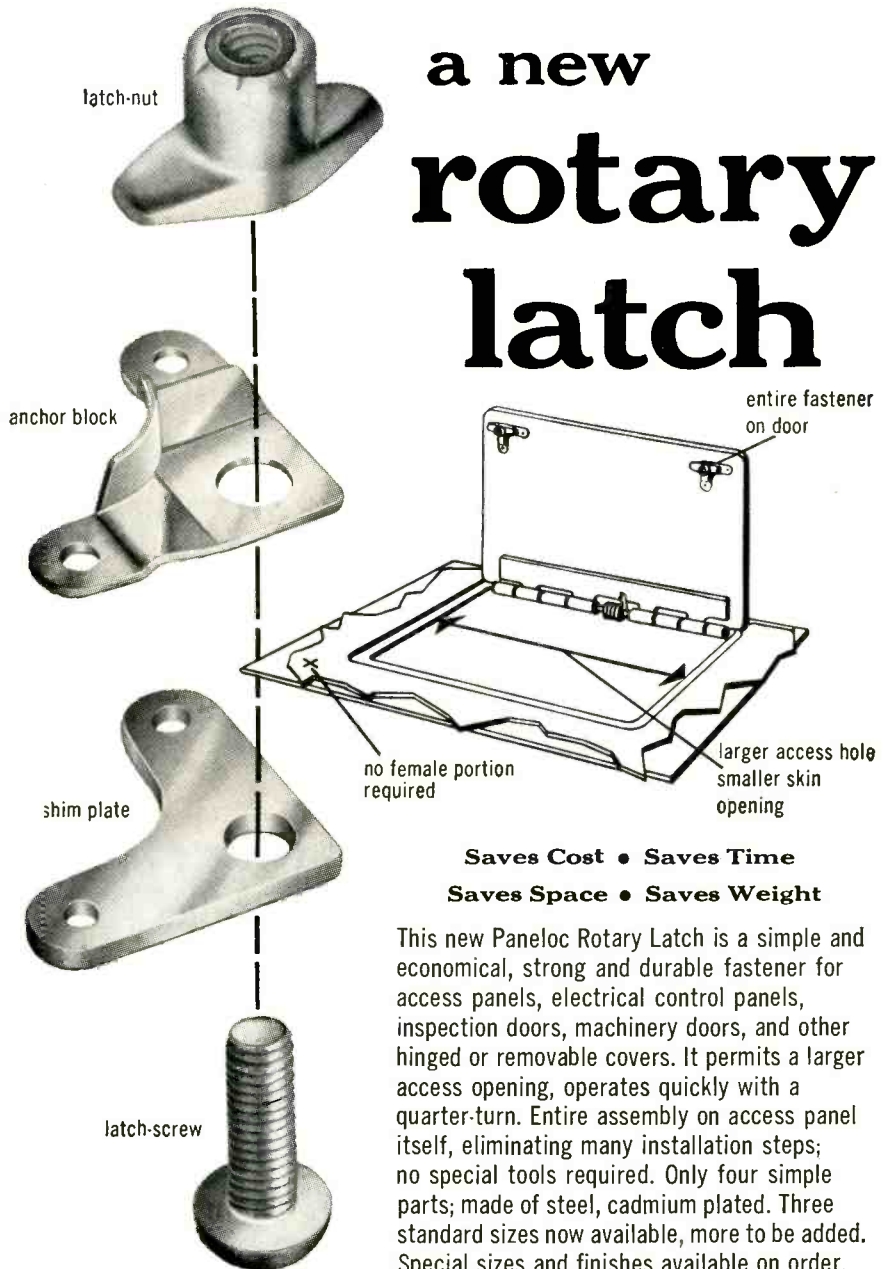

Saves Cost • Saves Time
Saves Space • Saves Weight

This new PaneLoc Rotary Latch is a simple and economical, strong and durable fastener for access panels, electrical control panels, inspection doors, machinery doors, and other hinged or removable covers. It permits a larger access opening, operates quickly with a quarter-turn. Entire assembly on access panel itself, eliminating many installation steps; no special tools required. Only four simple parts; made of steel, cadmium plated. Three standard sizes now available, more to be added. Special sizes and finishes available on order. Cost very low, performance unsurpassed. Write for a catalog and price list for your file.

PANELOC...America's most versatile line of aircraft fasteners... Rotary Latches, Styles 1, 2, and 3 Panel Fasteners, High Performance Fasteners, Snap Fasteners.



PANELOC—A product of Scovill



Scovill Manufacturing Company, Aircraft Fastener Div.
46 Mill Street, Waterbury 20, Connecticut
Please send me fastener catalogs checked:
 Rotary Latch Style 3 (MIL-F-5591A)
 Styles 1 & 2 (MIL-F-5591A) High Performance (NAS-547)
 Snap Fasteners (AN 227)
 Send to:
 Name _____ Title _____
 Company _____
 Address _____

New Bi-Directional Power Monitor



25 to 1,000 mc

10 to 500 watts

Only 2 plug-in elements

MODEL 164

Quickly measures incident or reflected power, simplifies matching loads to lines

New Sierra Model 164 is a compact, versatile, bi-directional monitor for intermittent or continuous measuring of incident or reflected power, or convenient and precise matching of loads to lines. The instrument offers unequalled measuring ease and economy, since only two plug-in elements are required for coverage of all frequencies 25 to 1,000 mc and wattages 10 to 500 watts. Two plug-in elements cover, respectively, 25 to 250 mc and 200 to 1,000 mc. Both have 4 power ranges: 10, 50, 100 and 500 watts. Accuracy is $\pm 5\%$ full scale. No auxiliary power is required to operate the instrument.

Because of its compact size and wide range, Model 164 is ideal for portable applications (mobile, aircraft, etc.) as well as laboratory use. It is supplied in a sturdy carrying case (one or both plug-in elements supplied as ordered) and both meter and directional coupler may be removed from the case for remote monitoring. The monitor may be equipped for most connectors normally employed with 50 ohm lines. A twist of the wrist selects incident or reflected power, or any power range, without requiring removal of power. No exchange of plug-in elements is necessary to read low levels of reflected power.

TENTATIVE SPECIFICATIONS

Power Ranges: 10, 50, 100 and 500 watts
full scale direct reading

Accuracy: $\pm 5\%$ of full scale.

Insertion VSWR: Less than 1.08.

Frequency Ranges: 25 to 1,000 mc. Two plug-in elements.

Low Frequency Elements: 25 to 250 mc.

High Frequency Elements: 200 to 1,000 mc.

Impedance: 50 ohm coaxial line.

Data subject to change without notice.

sierra
S



Sierra Electronic Corporation
San Carlos 2, California, U. S. A.

Sales representatives in major cities
Manufacturers of Carrier Frequency Voltmeters, Wave Analyzers, Line Fault Analyzers, Directional Couplers, Wideband RF Transformers, Custom Radio Transmitters, VHF-UHF Detectors, Variable Impedance Wattmeters, Reflection Coefficient Meters.

vacuum enclosure. Switch capacitance between contacts is $0.33 \mu f$, and operate time is less than 30 milliseconds. Size is $4\frac{1}{2}$ in. long and 4 in. in diameter.

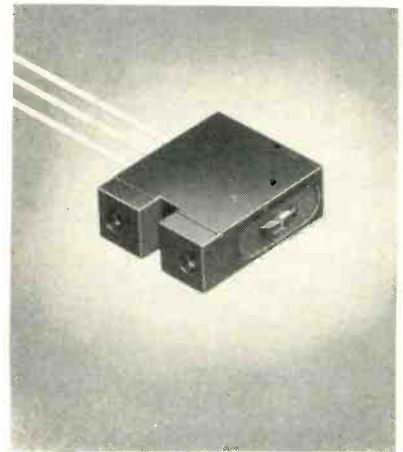

READ-RECORD HEADS dust and moisture proof

LIBRASCOPE, INC., 808 Western Ave., Glendale, Calif. Model MH-10-A was specifically designed for low-cost recording or reading on magnetic drums in memory systems of digital computers. Simplicity of design, flexibility of operation, high readback signal, low noise and h-v insulation are features. The writing or record current is usually low—less than 20 ma, while the readback voltage obtained is greater than 0.5 v peak-to-peak across 500 turns. Radial adjustment is 0.030 in. The unit is completely encapsulated in a die-cast aluminum case for moisture resistance, and has a 2-piece sintered core.

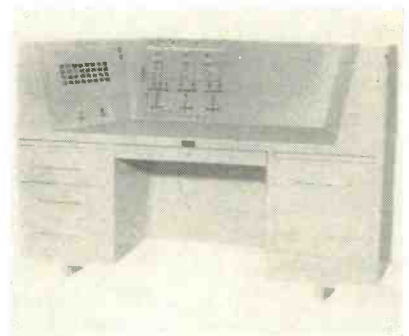

LAMP ANNUNCIATOR the graphic panel type

THE H. R. KIRKLAND Co., Morristown, N. J., announces the new

graphic panel type of lamp annunciator, designed to supervise automatic processes, flow patterns and the like. It is generally constructed in one of two ways: either nonlighted diagrams, with raised strips in various colors, with indicating lights at the desired positions; or using strips of translucent material, with light source behind front panel, producing a light spot at the desired point on the diagram. The annunciators can be supplied for mounting in a surface or flush cabinet, or on a slanting console, with or without the desk.

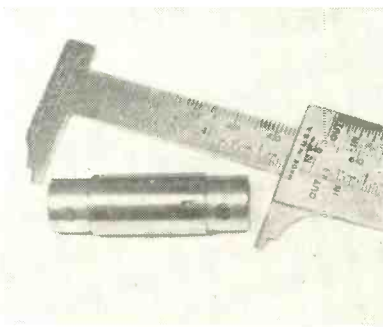

PRECISION CLUTCHES
in four basic types

PRECISION SPECIALTIES, 1342 E. 58th St., Kansas City 10, Mo., has introduced a line of miniature precision clutches featuring a positive displacement drive that will transmit up to 10 in. lb of torque at speeds up to 1,800 rpm. They are available in 4 basic types: single revolution, over-running, non-reversing and indexing. Both sleeve-end and through-shaft mounts are available. Small compact design and high torque capacity make the units ideal for use in business equipment, servomechanisms and computer devices.

SLIP SOCKETS
for solderless connection

TECHRON, INC., 254 Friend St., Boston, Mass. The Micro-Pin socket makes possible solderless connecting of diodes, transistors and other components into a circuit, particularly a printed circuit. Especially adaptable for subminiature assemblies, it has numerous applications in computers, guided

You can get **rugged, stable**
Corning Film-Type Resistors
in all these styles



LOW-POWER • In 3, 4, 5, and 7-watt sizes. Low-power—and low-cost. High resistance values available. Noninductive. Stocked by Erie Resistor distributors.

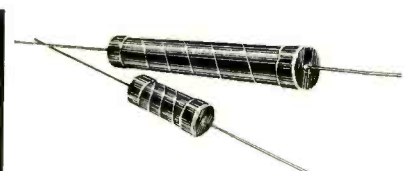

STYLE N • Designed for critical tolerance applications, rugged duty. Noise level very low. Extremely stable. Unaffected by moisture.

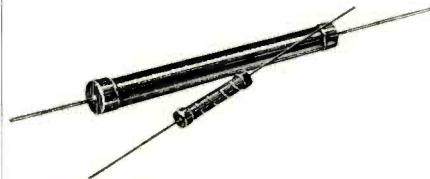

HIGH-TEMPERATURE—STYLE S • Stable performance up to 200°C. without encapsulation or hermetic sealing. For HF, test equipment, radio and TV, hi-gain amplifiers where low-noise, stable performance is needed.



WATER-COOLED—STYLE WC5 • For high-frequency, high-power TV, FM, low-reactance uses. Allows mounting on 3" coax line with both water intake and outlet at RF ground potential. Interchangeable resistance elements.

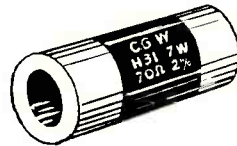

HIGH-FREQUENCY—STYLE H • Combine high-power with excellent high-frequency characteristics. Resistance film is continuous, spiraled or striped according to resistance range or application. Silver metallized bands fired-on ends for termination. Silicone coated: water-cooled types uncoated.



HIGH-POWER—STYLE R • 25 to 1,000,000 ohms; ratings from 7- to 115-watts; noninductive. Standard tolerance $\pm 2\%$ 10 to 1,000,000 ohms. Exceptionally good noise and frequency characteristics. Superior moisture resistance and overload capacity.

Now • 6 types ranging from 10Ω to 1MΩ, ratings from .5W to 150 W, with these advantages.

Stability • You can cycle the resistive element of Corning Resistors from near absolute zero to red heat without damage to electrical properties.

Moisture-Proof • Wet won't affect them. They pass MIL-R-10509A and MIL-R-11804A moisture resistance tests.

Durable • Rough handling doesn't affect them. The film material is fired on at red heat, makes an integral bond with PYREX brand glass base. No special handling needed.

Quiet • No need to use over-size resistors to avoid noise caused by soldering. Fired-in silver bands give low-load resistance, low-noise terminations.

Compact • Couple them close—without damage or noise.

Important • New products and new prices—news in general—happens fast here. Let us keep you posted with our New Products Catalog and supplements. Send the coupon for your free copy.



—Corning means research in Glass—

CORNING GLASS WORKS,
36-11 Crystal Street • Corning, N. Y.

Please send me your New Products Catalog.



Name Title

Company

Address

City Zone State



SINCE 1915 LEADERS IN AUTOMATIC CONTROL

NEW PRODUCTS

(continued)

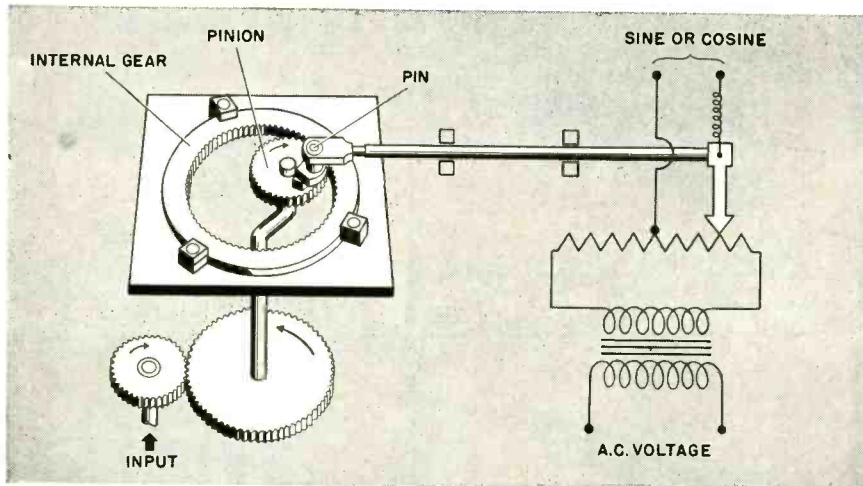

Ingenious electro-mechanical device generates sine or cosine function

From a combination of mechanical and electrical principles, Ford Instrument Company engineers have produced and patented an electro-mechanical device to generate sine and cosine functions. The mechanical portion is an internal-gear angle resolver. It consists of two gears — an internal gear and a pinion. Because the pinion has exactly half the number of teeth as the internal gear, the pin on its pitch circle traces a straight line when the pinion rolls inside the angle gear.

Furthermore, the displacement of the pin relative to the center of the internal gear is proportional to the sine (or cosine) of the roll angle of the pinion.

If a linear potentiometer is now placed along the diameter of the internal gear and a potentiometer slider is fastened to the pin on the pinion, the voltage picked off by the brush is proportional to the sine (or cosine) of the angle.

Two such systems, connected in tandem, produce simultaneously both the sine and cosine functions.

This is another example of Ford Instrument engineering ingenuity. What appears on the surface to be a complex problem is solved by the combination of well-known principles.

Perhaps you have a problem that could benefit from Ford Instrument experience. Ford Instrument engineers work every day with systems using mechanics, electronics, hydraulics, electro-mechanics, magnetics, atomics. How can Ford help you?



FORD INSTRUMENT COMPANY

DIVISION OF SPERRY RAND CORPORATION
31-10 Thomson Avenue, Long Island City 1, N. Y.

ENGINEERS

of unusual abilities can find a future at FORD INSTRUMENT COMPANY. Write for information.

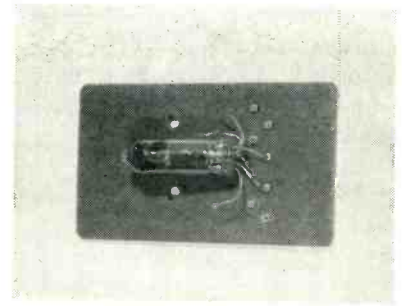

missiles, telemetering, small radio receivers and hearing aids. The unit is a spring-backed, plug-in socket made of copper alloy. Its outer shell is approximately 0.2 in. long and 0.08 in. in diameter. It is press-fitted and dip-soldered into the circuit board. Diameter of the socket is such that the receiving hole in the circuit board can be either punched or drilled. The sockets are currently available from stock to fit leads of 0.016 in. diameter and will soon be available for lead sizes of 0.175 in. and 0.022 in.

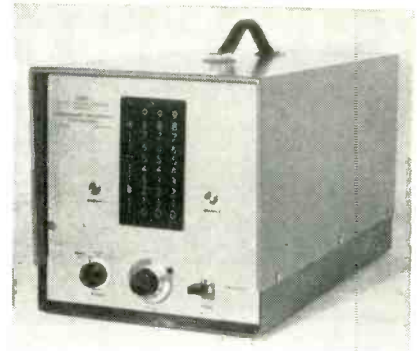

DIGITAL VOLTMETER designed for bench-top use

CONSOLIDATED ENGINEERING CORP., 300 N. Sierra Madre Villa, Pasadena 15, Calif. Type 33-110 Sadic digital voltmeter has a sensitivity such that 10 mv provides full-scale digital output (999). Controls permit selection of any voltage in either of two ranges (10 to 25 and 20 to 50 mv) for full-scale readout. Output may be used for operation of automatic typewriters, card punches and tape punches. Designed for bench-top use, the instrument requires no external power supply other than 115-v, 60-cycle a-c. Input signals must remain constant long enough for the Sadic to attain balance. Strain

gages, pressure pickups, load cells, position-measuring potentiometers, thermocouples, analog computers, and mass spectrometers are a few of the devices which may provide this type of signal. This analog-to-digital converter operates on the self-balancing Thomson-Varley potentiometer principle and has 1,000 discrete balance positions. It attains balance in a maximum of 0.8 sec. The converter measures approximately $9\frac{1}{2}$ by 10 by $18\frac{1}{2}$ in. Additional details are contained in CEC bulletin 3002.



HOT TUBE PULLER
built in two models

HUNTER TOOL Co., 6608 S. Gretna Ave., Whittier, Calif., has added a hot tube puller to its line. Built in two models—on straight and one bent at a 90-deg angle (illustrated)—the tube puller is designed to remove hot tubes in a jiffy. It is easy to operate. Just clamp over the desired tube and pull up and out.

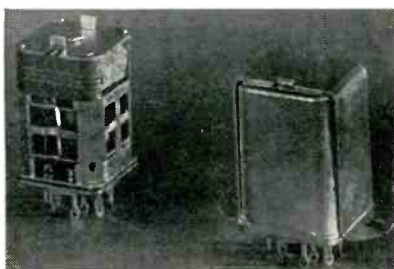

RELAY
withstands vibration, shock

BARTH ENGINEERING AND MFG. Co., Milldale, Conn., announces completion of the development of a premium relay specifically aimed

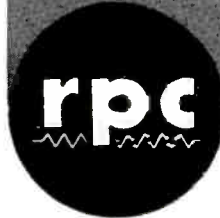
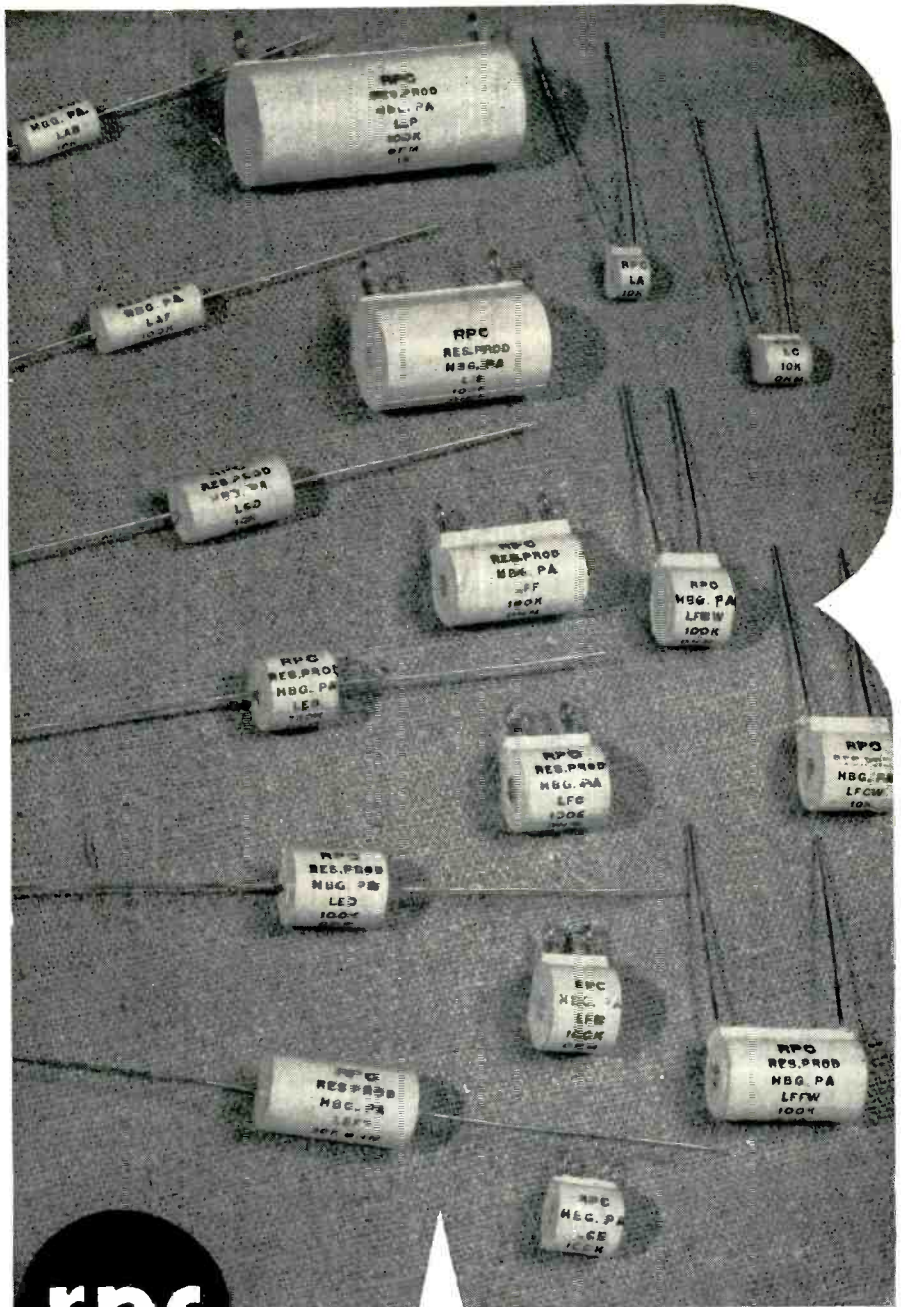

Encapsulated Precision Wire Round Resistors
Defy Shock, Vibration and Extreme Changes

Completely sealed in epoxy resin, RPC has engineered Type L Resistors that are protected against extremes of humidity, temperature, altitude conditions, corrosion, shock and mechanical damage. Type L Resistors meet requirements of military specification MIL-R-93A, Characteristic A.

RPC can supply Type L with lug terminals or wire leads in a complete line of standard, midjet and sub-miniature sizes. All resistors are wound with low temperature coefficient alloys unless otherwise specified. Resistance tolerances to $\pm 0.02\%$ available. Resistors can be furnished with special temperature coefficients and matched characteristics.

Networks, ratio resistors, special assemblies and types for high temperature operation are made to meet specific requirements. Our Engineering Department is available for consultation on resistor problems.

Sales representatives in principal cities of the United States.

Write for additional information without obligation.

RESISTANCE PRODUCTS CO.

914 SOUTH 13TH ST. HARRISBURG, PENNA.

Manufacturers of High Quality Resistors

Precision Wire Wound—High Voltage—High Megohm—High Frequency

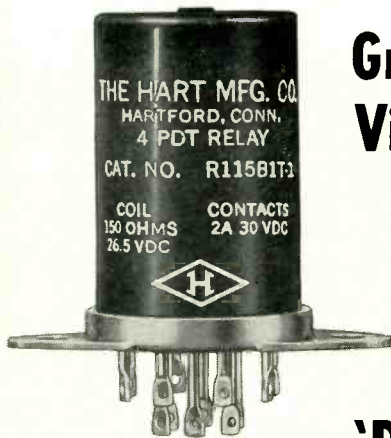

Shown Actual Size

Greater Sensitivity, Vibration Resistance Engineered in



'Diamond H' Relays

Continuing development of "Diamond H" miniature, hermetically sealed, aircraft type relays is constantly widening their performance range. Now, for example, in a 4 PDT relay: sensitivity to 85 mw with vibration resistance of 500 cycles at 10 "G" and 30 "G" shock resistance; vibration resistance of 55 to 2,000 cycles at 20 "G" with 50 "G" shock resistance and maximum sensitivity of 1½ watts.

Excellent contact reliability makes "Diamond H" relays preferred choice for critical jobs in vital applications ranging from guided missiles to high speed camera equipment.

TYPICAL PERFORMANCE CHARACTERISTICS

Vibration Resistance:	10-55 cycles at 1/16" double amplitude 55-500 cycles at 15 "G" 55-1,000 cycles at 15 "G" 55-2,000 cycles at 20 "G"
Temperature Range:	—55° to + 85°C. —65° to + 125°C. —65° to + 200°C.
Coils:	Resistances—1 ohm to 50,000 ohms Arrangements—single coil; two independent coils, either or both of which will operate unit
Insulation Resistance:	1,000 megohms at room temperature 100 megohms at 200°C.
Dielectric Strength:	450 to 1,250 V., RMS
Operating Time:	24 V. models 10 ms. or less; dropout less than 3ms.
Contacts:	30V., D.C.; 115V., A.C.; 2, 5, 7½ and 10A., resistive; 2 and 5A. inductive. Minimum 100,000 cycles life. Low interelectrode capacitance — less than 5 mmf. contacts to case; less than 2½ mmf. between contacts. Special Ratings: to 350 V., D.C., 400 MA., or other combinations including very low volt- ages and amperages or amperages to 20.
Operational Shock Resistance:	30, 40 and 50 "G" plus
Mechanical Shock Resistance:	up to 1,000 "G"
Mounting:	9 standard arrangements to meet all needs — plus ceramic plug-in socket.
Size:	1.6 cu. in.
Weight:	4 oz. or less

Call on "Diamond H" engineers to work with you in
developing a variation to meet your specific requirements.

THE HART MANUFACTURING COMPANY
202 Bartholomew Avenue, Hartford, Connecticut

at extreme vibration and shock environments. The company is now producing a four-pole double-throw version of the relay.



SERVO MOTOR in high temperature unit

JOHN OSTER MFG. CO., 1 Main St., Racine, Wisc., now offers a new high temperature size 15, 400-cycle servo motor which also meets Mark 7 specifications. Operating temperatures up to 150 C continuous 1,000 hour ambients have been attained. Extremely small air gap results in top performance for a high torque-to-inertia ratio. Humidity protection is given by encapsulating the entire stator in a thermosetting resin to meet MIL-E-5272A. Series 2287 has stainless steel ball bearings and meets MIL-S-17087 specifications. Dimensions are 1.437 in. o-d by 1.640 in. long. Weight is 8 oz, minimum stall torque 1.45 in. oz, no load speed 4,800 rpm minimum and power input at stall is 12.2 w total.



STRIP CHART RECORDER of the multiple-range type

APPLIED PHYSICS CORP., 362 W. Colorado St., Pasadena, Calif., is now producing a multiple-range strip chart recorder, which automatically switches between a series

of full-scale ranges of 0 to 110, 100 to 210 and on up to 900 to 1,010 mv. Model 39 recorder is particularly useful for applications, such as measuring small voltages or currents with an electrometer, where emf values must be recorded with high accuracy over a wide range of values. Range switching is performed by limit switches at the ends of the recorder slidewire, so that a higher or lower range is automatically selected when the recorder pen reaches either end of the scale.

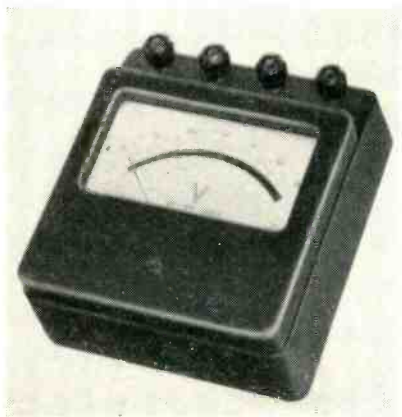

METERS in a wide variety of types

PHYSICS RESEARCH LABORATORIES, INC., 507 Hempstead Turnpike, West Hempstead, N. Y., announces the new C. P. Goerz (Vienna) precision (± 0.5 percent) moving coil ammeters, milliammeters, microammeters, galvanometers, voltmeters and high sensitivity millivoltmeters and electrodynamic single and three phase (both three and four wire) wattmeters. Most models are available for a-c and d-c. With the aid of accessories currents as high as 300 amperes may be measured. The millivoltmeters can be converted to h-f ammeters (ranging from 50 amperes at 800 kc to 200 ma at 50 mc) by separate thermotransformers. All units have mirror scales, knife-edge pointers, are light and compact. Catalogs are available.

BATCH COUNTERS for industrial application

THE COMPUTER-MEASUREMENTS CORP., 5457 Cleon Ave., North Hol-

TEFLON*

PARTS OR MATERIALS
FOR UHF APPLICATION?

FOR MINIATURE AND
SUB-MINIATURE COMPONENTS?

YOU CAN GET JUST WHAT YOU WANT

from

JOHN CRANE

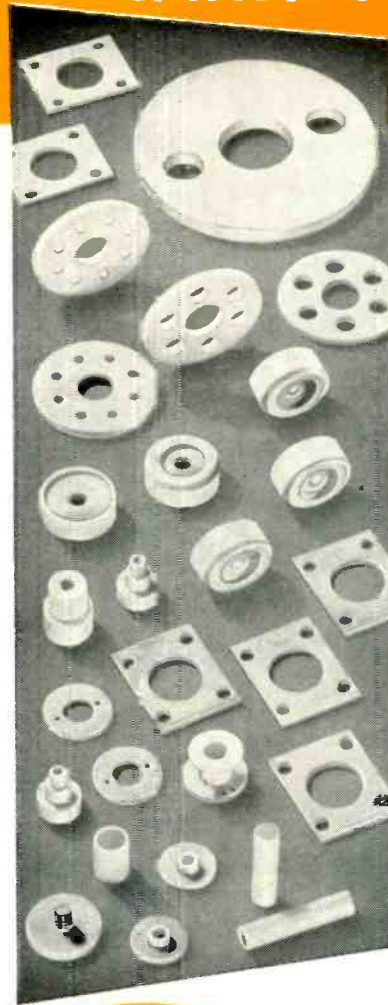

FOR: insulators of all types, sleeves or inserts, capacitor seals, feed through insulators, bushings, slot liners, coaxial spacers, layer insulation or any other parts or forms subject to high charge, extended frequency range, mechanical and thermal shock, extreme temperatures and climatic conditions.

You can order in any quantity and be sure of true Teflon performance, because "John Crane" gives you these *plus* factors: complete uniformity throughout, high density control, freedom from flaws and rigid adherence to your specifications.

"John Crane's" complete fabrication facilities assure you prompt delivery on *exactly* what you want. If you have an entirely new requirement, no standard design or procedure—"John Crane's" laboratory facilities, know how, research and engineering experience go to work on *your particular* need.

Now is a good time to put "John Crane" to test. Contact Crane Packing Company today.

Crane Packing Co.,
1802 Cuyler Ave.,
Chicago 13, Illinois

In Canada: Crane
Packing Co., Ltd.,
617 Parkdale Ave.,
N., Hamilton, Ont.



*TEFLON DuPont
trademark

Dielectric Strength: 480 v/mil.
Dielectric Constant (60 to 10⁶ cycles): 2.0
Power Factor (50 to 10⁶ cycles): < 0.0005
Volume Resistivity: 10¹⁵ ohm-cm
Surface Resistivity: 3.6x10⁶ megohms
Surface Arc-Resistance: does not track
Temperature Range: -450° to +500°F.
Chemical Resistance: completely inert
Moisture Absorption: zero

JOHN CRANE

CRANE PACKING COMPANY

OFFICES IN ALL PRINCIPAL CITIES

38
YEARS
INDUSTRIAL PROGRESS

**20
TO
200 D.P.**

**SEND YOUR
PRINTS FOR
QUOTATION**

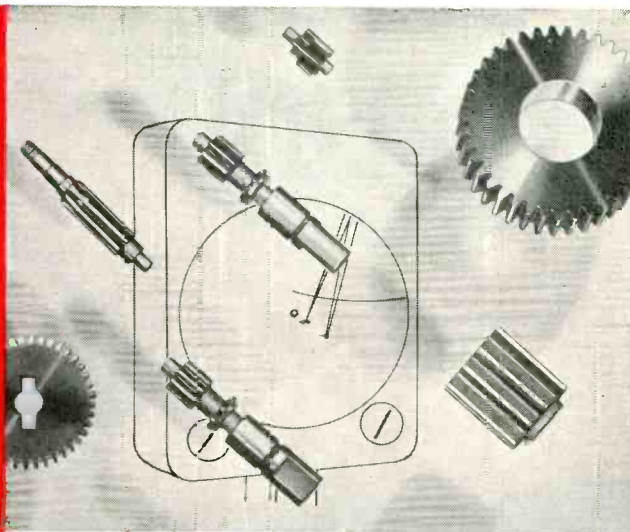

SPURS • HELICALS • WORM AND WORM GEARS • STRAIGHT BEVELS
LEAD SCREWS • RATCHETS • CLUSTER GEARS • RACKS • INTERNALS • ODD SHAPES

THE *Finest*

IN GEARS



Beaver Gear Works Inc.

1021 PARMELE STREET, ROCKFORD, ILLINOIS

REL RADIO ENGINEERING LABORATORIES, INC.

prove **MAGNATRAN** *dependability*



(Type L3-01) Askarel immersed Filter Reactor.



(Type J3-01) Askarel immersed high impedance Filament Transformer.



(Type N3-01) Unitized Rectifier askarel immersed for Klystron Bombarding.

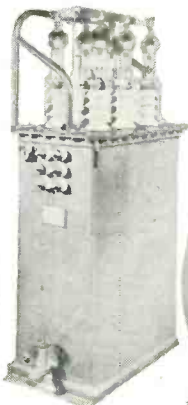

(Type N3-02) Unitized Rectifier askarel immersed Beam Supply.

"Magnatran components have contributed considerably to the fact that REL now makes more beyond-the-horizon FM multiplex relay equipment than all other manufacturers combined. They have been proven in use to be very dependable, both in performance and maintenance."
Join the ranks and enjoy reliable Magnatran magnetic components for the electronics industry.

Write for Catalog

MAGNATRAN
incorporated
KEARNY, NEW JERSEY, U.S.A.

NEW PRODUCTS

(continued)

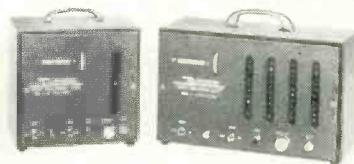

lywood, Calif. The Detectron DS-700 series batch counters are dependable, direct-reading totalizing electronic counters especially designed for such applications as: industrial batch counting, measuring characteristics of jet engines, turbines, electric motors, and counting total revolutions of high-speed shafts. Available in four models the series will operate with absolute accuracy from 0 to 100,000 counts per second, depending on the number of decades. Relay contact closure and negative output pulse of approximately 100 v is provided each time the electronic decade section reaches maximum count. Relay contacts are rated at 5 amperes, 115 v, 60 cycles. Net weight ranges from 8½ lb on the 1-decade unit to 13½ lb on the 4-decade unit. Complete specifications are available on request.

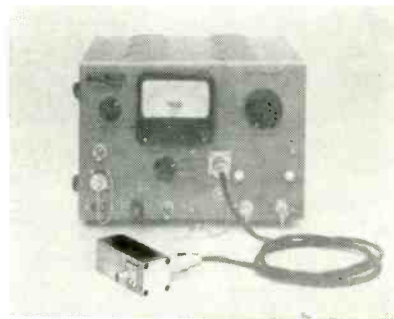

NOISE DIODE PROBE
for very high frequencies

RS ELECTRONICS CORP., 435 Portage Ave., Palo Alto, Calif., announces production of an accessory noise diode probe which may be used with the company's noise generators for very high frequencies, or when low output capacitance is required. The probe contains a separate noise diode which places the noise source directly at the amplifier input (or other apparatus) under test. Lead length problems at

very high frequencies are thereby minimized. The capacitance and resistance of the noise source is adjusted by changing the resistor or variable shunt capacitor within the probe. The probe cord plugs into the front panel of the noise generator; a front panel switch on all RS noise generators selects either the internal noise diode or the probe.

Literature

High-Stability Resistors. Pyrofilm Resistor Co., 8 Whippany St., Morristown, N.J., has available bulletin PT1000 on new glass-sealed carbon film resistors. The resistor described offers particular advantages in high-precision networks. Described in the literature is the stability characteristic of the resistor which is ± 0.03 percent per year at 0.5 w rating and derating to zero power at 140 C. With a 1-w rating, derating to 160 C, stability is better than ± 0.1 percent in 1,000 hr. Resistance values indicated in the literature range from 1 ohm to 30 megohms. Leads can withstand up to 15-lb pull. Actual size is $\frac{3}{8}$ in. diameter by $\frac{1}{8}$ in. measured the length of the resistor body.

Coaxial Terminations and Directional Couplers. The Narda Corp., 160 Herricks Road, Mineola, L. I., N. Y. Four models of coaxial directional couplers offering complete power measurement over the most widely used frequency ranges from 225 to 4,000 mc, are described in catalog sheet 282. A new line of fixed and sliding coaxial terminations, covering the entire frequency range from S to X bands (2,400 to 12,400 mc), are described in catalog sheet 302. Photographs, applications, features, specifications and prices are included in both catalog sheets.

Radio Interference Suppression. Metal Textile Corp., Roselle, N. J., has available a booklet discussing the suppression of radio interference with Metex electronic

FOR SCIENCE and INDUSTRY

the Electro-Pulse VARIABLE PULSE GENERATOR

- Operation to 330 KC
- Variable Duration and Delay
- Low Internal Impedance

LOW COST ...

HIGH PERFORMANCE



Model 4120A

A truly wide-range laboratory-type unit — a basic instrument for pulse circuit test and development. Its versatility, compactness and simplicity of operation allow wide application in production and laboratory testing of:
Computers... Telemetry... Television... Magnetics
... Nuclear Research and Development... Radar
... Navigational Systems.

- 33 CPS to 330 KC Rep. Rate • 1 to 100 μ s Delay • .25 to 100 μ s Pulse Width • At least 60 V Amplitude • .1 μ s Rise Time • Blocking Oscillator Sync. Pulse • $5\frac{1}{4}$ " x 19" Standard Rack Panel • Complete with Regulated Power Supply

Write for Complete Data: Our Bulletin 4120A/E

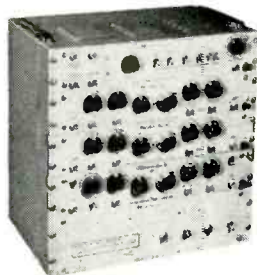

◀ Model 2100A PULSE GENERATOR

The Model 4120A Variable Pulse Generator is the latest addition to the Electro-Pulse line of pulse instrumentation which includes Analog and Digital Time Delay Generators, Pulse Oscillators and the 2100 series precision Pulse Generators

Representatives in Major Cities

EP *Electro-Pulse, Inc.*

11861 TEALE STREET, CULVER CITY, CALIFORNIA
Telephones: EXmont 8-6764 and TExas 0-8006

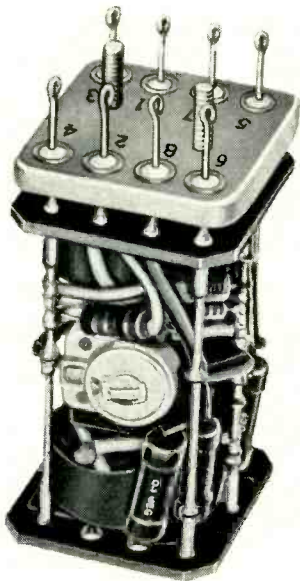

Your filters can be no better than the engineering and winding of the coils with which they are made.

And Barker & Williamson has had longer experience in the engineering and winding of coils than *any other manufacturer*

. . . dating back to B & W's introduction of the world's first Air Inductor.

Single layer solenoid coils . . . universal units with single, multiple pie, or progressive windings . . . r-f, i-f, and oscillator coils . . . traps, discriminators, toroids, filters, r-f and delay line chokes.

B&W

Barker & Williamson, Inc.
237 Fairfield Ave., Upper Darby, Pa.

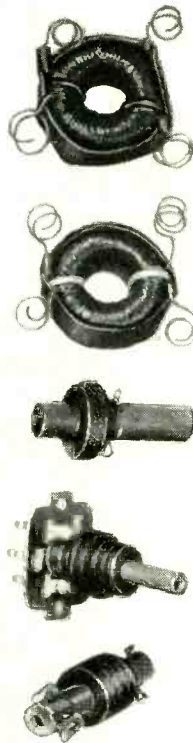

weatherstrips and r-f gaskets. Types, shapes and sizes of shielding products are illustrated and described. The booklet tells how to specify and lists normal tolerances.

Capacitor Literature. General Electric Co., 1 River Road, Schenectady 5, N. Y., has published the following new pamphlets on capacitors: (1) GED-2620, describing the basic characteristics of specialty capacitors for use in electronic systems. (2) GET-2417, giving a complete listing of GE capacitors for the electronic industry with basic applications, ratings, tolerances and temperature ratings. (3) GEA-4996B, an explanatory bulletin on the functions of networks and methods of determining the suitable unit for each application. A capacitor network application data sheet, essential for all radar and missile applications, is included. (4) GET-2333G, giving specifications for Tantalum capacitors. (5) Two bulletins on the 125 C Tantalum capacitors. Bulletin GET-2502 describes the rectangular case units; GET-2513, the cylindrical, double case units. (6) GEA-6258 gives general information on the company's new lines of tantalum foil capacitors for high temperature applications.

Production Facilities. Telectro Industries Corp., 35-16 37th St., Long Island City 1, N. Y., has published a 24-page booklet describing facilities and typical products. Sections of the booklet describe in text and illustration the corporation's facilities for designing and engineering service, production personnel, and testing. A list of available machine tools and electronic test equipment is included. Typical products are illustrated with line drawings and photographs showing assemblies and subassemblies; aircraft industry equipment; recording and audio equipment; electronic test equipment; interphone and control equipment; electronic industry equipment, and special products and facilities.

Wire-Wound Resistors. Precision, Inc., 730 Lyndale Ave. North,

Minneapolis, Minn. An 8-page brochure describes various types of wire-wound resistors now available. It also contains valuable information in the form of an alloy characteristics chart listing symbols, alloys, trade names, nominal temperature coefficients, thermal emf on copper, and a guide to proper selection. The bulletin covers fixed, adjustable, tapped multisection, pigtail terminal, and ferrule terminal vitreous enamel, as well as wire-wound precision resistors, and includes photographs of each available type.

Explosive-Driven Cutters. Beckman & Whitley, Inc., 915 E. San Carlos Ave., San Carlos, Calif. Three designs of guillotine-type explosive-actuated cable cutters (covering a wide range of destruct requirements in most of the major missiles in production and under development) are described in a new leaflet, Form EDC-555. Similar in overall arrangement, the three types illustrated vary primarily in the diameter of the cables they are able to cut. These include 9/16 in. and 1 1/8 in. diameters, and 2 1/4 in. by 1 1/2 in. maximum packs. Besides being illustrated photographically, the units are detailed with scaled dimensional drawings and specifications.

Rectifier Power Supplies. Opad Electric Co., 69 Murray St., New York 7, N. Y. To facilitate quotation on special and custom-built rectifier power supplies, the company offers a 2-page power equipment questionnaire form as a convenience in specifying power supply requirements. The form is designed to reduce the many variables down to a simple selection arrangement and eliminates the possibility of overlooking any important features or requirements. Copies of form PEQ are available on request.

Toroidal Coil Winding Machine. Arnold Magnetics Co., 5962 Smiley Drive, Culver City, Calif. A new 4-page folder describes a portable toroidal coil winding machine used for both laboratory and pro-

SIE

MODEL C-6

RESISTANCE METER

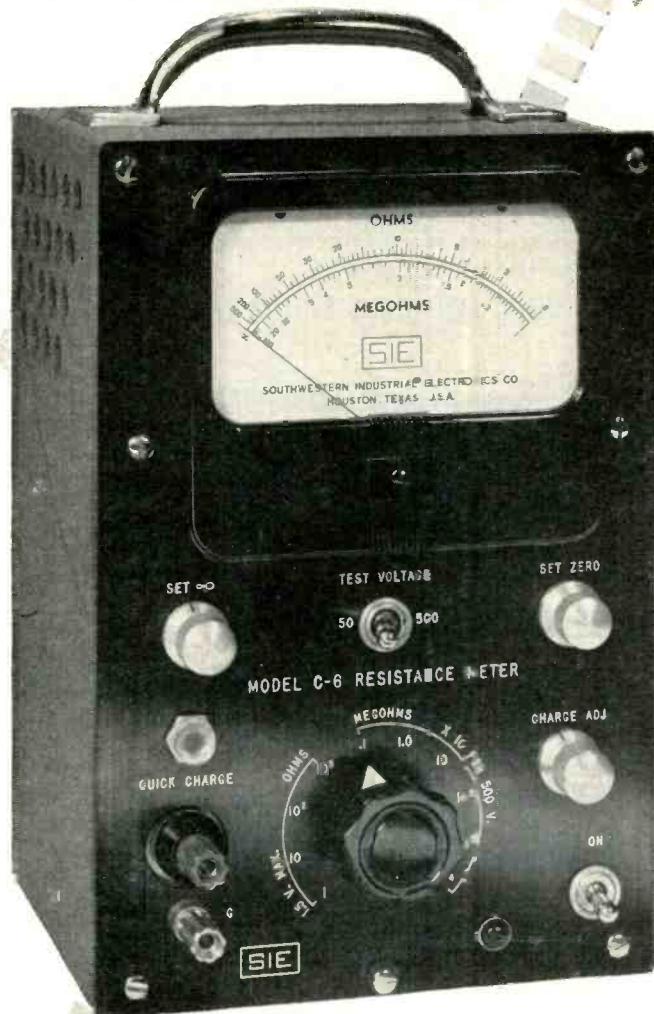

**DIRECT READING FROM 0
OHMS TO 10,000,000
MEGOHMS**

- 3 TEST VOLTAGES: 1 1/2, 50, 500 VOLTS
- ACCURATE WITHIN 3% TO 1,000,000 MEGOHMS
- PRE-SETTABLE "CHARGE ADJUST" CONTROL FOR RAPID GO, NO-GO CAPACITOR CHECKING

\$200

SIE

SOUTHWESTERN INDUSTRIAL ELECTRONICS CO.

Industrial Instruments Division

P. O. BOX 13058

2831 POST OAK ROAD

HOUSTON 19, TEXAS

219-55

WHITNEY BLAKE CORD and CABLE



FOR POWER SUPPLY, COMMUNICATIONS AND ELECTRONIC APPLICATIONS
ADVANCED DESIGN, HIGHEST QUALITY

MICROPHONE CABLE

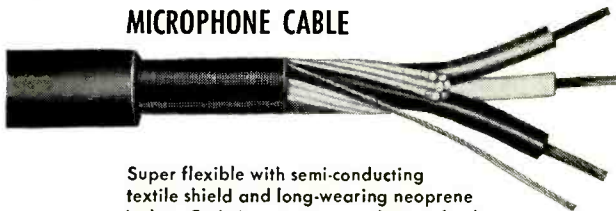

Super flexible with semi-conducting textile shield and long-wearing neoprene jacket. Cadmium copper conductors for long flex life, insulated with high dielectric strength rubber. Noisy circuits are eliminated. Other types also available.

SPEECH INPUT AND SOUND SYSTEM CABLES



Semi-rigid polyvinyl chloride Types. Solid or stranded conductors with bare or tinned copper shield. And, with cotton braid or Plastite® jacket. Also, Enamel Textile Types.

SIGNAL WIRES



Bare soft copper conductors insulated with high dielectric strength polyvinyl chloride insulation. Underwriters' Laboratories approved for fire and burglar alarm system internal wiring.

INTERCOMMUNICATIONS CABLES



TELECABLE® Multiconductor Paired Inside Wiring Cable

Semi-rigid polyvinyl chloride insulation, brown or ivory polyvinyl chloride jacket. Light weight, easy to install, unaffected by humidity.

PORTABLE CORDS



Underwriters' Laboratories approved — for power supply on electrical equipment. Neoprene jacketed DYNAPRENE® and rubber jacketed types.

CORD SETS AND CABLE ASSEMBLIES

Custom-built to customer's requirements. Using either standard cordage or cord designed to fit your particular application, Whitney Blake can furnish regular line cords or special purpose cords having attached or integrally molded rubber or Plastite fittings.

Well Built Wires Since 1899



© 1955
WHITNEY BLAKE COMPANY

New Haven 14, Connecticut

NEW PRODUCTS

(continued)

duction requirements. The literature explains how the machine sets up quickly, is easy to operate, accommodates a range of wire sizes from Awg 26 to 44, and winds at speeds up to 1,500 turns per minute.

Connectors. Whitney Blake Co., New Haven 14, Conn., has available a 4-page folder entitled "A New Approach to Connector Problems". The illustrated folder shows the company's new electrical connectors and explains how many types of AN connectors can be built up from a few basic components, thereby reducing greatly the number of parts that must be stocked. The connectors described give weight and space savings, are built to Army-Navy Specification MIL-C-5015B, and are waterproof, vibration proof and environmental resistant. The folder also illustrates new types of termination provided and describes the new enclosed type socket contact developed for these connectors to provide protection against test prods and abnormal abuse.

Pulse Signal Simulator. Haller, Raymond and Brown, Inc., State College, Pa. A single sheet illustrates and describes the model 60.3-01 pulse signal simulator which is designed to simulate typical radar signals and other signals as training aids, or for use as a piece of test equipment. Power supply requirements, mechanical specifications and electrical characteristics are given.

Switch Brochure. General Devices Inc., P. O. box 253, Princeton, N. J., has published a 4-page, 2-color brochure on high-speed multicontact sampling switches. It illustrates the company's three basic proven switch designs which are available with a wide variety of contact arrangements and integrated motor drives for use in military, scientific and commercial purposes. Detailed photos show the variety of applications. Also illustrated is a performance chart showing the extended service-free life of a typical 60-contact 300-rpm switch, covering one year's continuous operation and over 50,-

000,000 revolutions. Featured in the brochure is the new Perma-Brush. The constant force characteristics of this design results in minimum wear and enables maximum performance.

Radiation Measuring Equipment. Nuclear Instrument and Chemical Corp., 229 W. Erie St., Chicago 10, Ill. A 48-page, 2-color catalog describes a complete line of radiation measuring equipment for medical, industrial and research applications. Included are photographs and descriptions of individual instruments as well as suggested groupings of units for specific applications. Scalers, count-rate meters, portable instruments, Geiger, proportional and scintillation counters are described.

Magnetic Null Indicator. Doelcam, a division of Minneapolis-Honeywell Regulator Co., 1400 Soldiers Field Road, Boston 35, Mass. A new 2-page bulletin covers the Magnetik null indicator, a portable temperature measuring instrument. The bulletin provides complete engineering data on the low-level, linear-deflection d-c null indicator. Included is a technical description of the engineering concept of the division's second harmonic magnetic converter covering such features as isolated input, immunity to 60-cycle pickup, and rugged design.

Analog-To-Digital Converter. J. B. Rea Co., Inc., 1723 Cloverfield Blvd., Santa Monica, Calif., is offering an 8-page illustrated brochure describing the company's analog-to-digital converter and systems in which it operates. Illustrated with photographs and block diagrams, the brochure describes the high-speed, accurate operation (0.1 percent accuracy) of the REA-Converter. Also described is a typical system, incorporating a new high-speed input commutation switch, digital output magnetic recorders and programming circuits.

Potting Connectors. Cannon Electric Co., 422 W. Avenue 33, Los Angeles 31, Calif. Numerous il-

EAGLE FLEXOPULSE

repeat cycle timer

WITH S. P. D. T. SWITCH

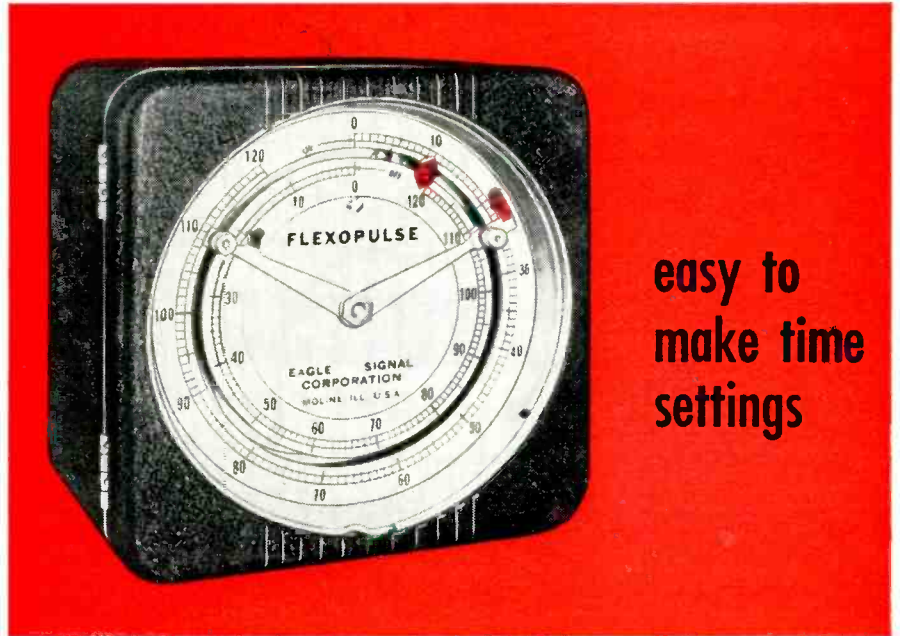

easy to
make time
settings

No gear change or resetting of cams required

This Flexopulse Repeat Cycle Timer is ideal for controlling processing machines requiring adjustable timed cycles. The "on" or "off" intervals are easily adjusted. Either can be adjusted without disturbing the setting of the other. Instead of resetting cams or changing gears, simply loosen two knurled nuts. Then set "on" and "off" periods by moving adjustable pointer. Tighten screws, and the job's done.

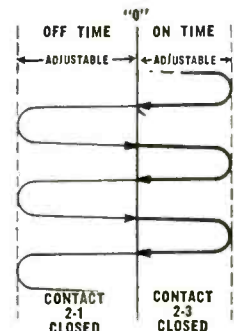

HAS CYCLE PROGRESS INDICATION:

A movable flag indicator passing over the time scale between adjustable arms, indicates portion of cycle elapsed in either of the s.p.d.t. positions. Switching operation takes place at zero.

Flexopulse is ideal for periodically operating valves to reverse the flow of liquids, for operating signals or for injecting chemicals. 120-second up to 20-hour dials are available. Synchronous motor powered. Send coupon today for free Bulletin 320.

FREE BULLETIN, MAIL COUPON

EAGLE TIMERS SAVE TIME . . . SAVE MONEY



SIGNAL CORPORATION
Industrial Timers Division
MOLINE, ILLINOIS

EAGLE SIGNAL CORPORATION
Industrial Timers Division, Dept. E-1155
MOLINE, ILLINOIS

Please send free Bulletin 320 with full data on Flexopulse Repeat Cycle Timer.

NAME AND TITLE _____

COMPANY _____

ADDRESS _____

CITY _____ ZONE _____ STATE _____

GIGANTIC antenna unveiled

Here is one of the world's largest antennas . . . designed, fabricated, and installed by D. S. Kennedy & Co. Whatever the shape, size, or scope of your antenna, Kennedy's versatile staff of specialists has the know-how and facilities to solve your problem.

another **KENNEDY** installation

This gigantic VHF antenna stands 120 feet high and is 130 feet wide. Located in South Dartmouth, Mass., it transmits to Cedar Rapids, Ia. — 1100 miles away — and is a vital link in our radar defense system. The smaller "dish" antennas, also by Kennedy, are 28 feet in diameter.

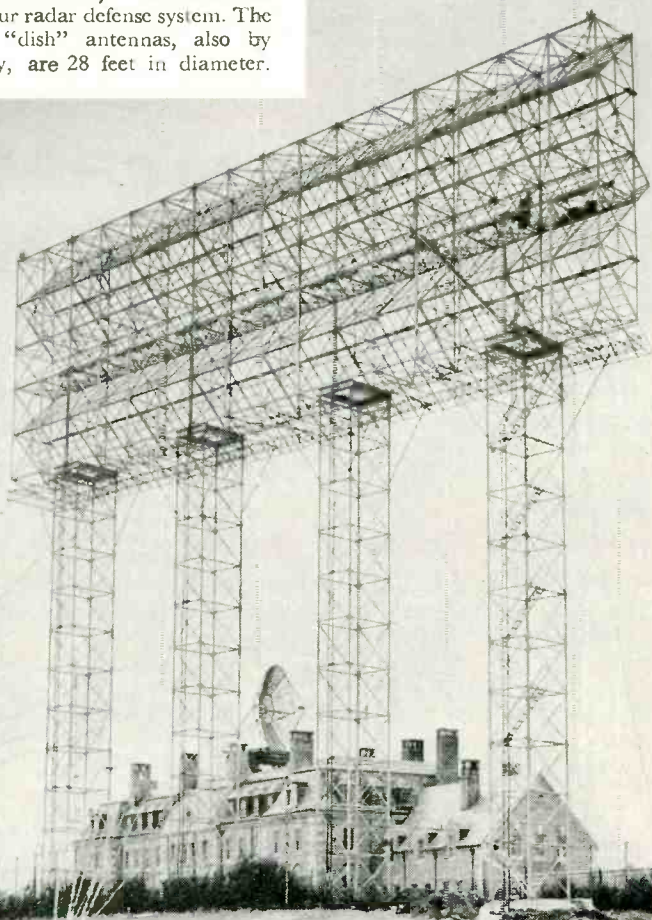

ANTENNA EQUIPMENT

D. S. KENNEDY & CO.

COHASSET, MASS. — TEL: CO4-1200

illustrations coupled with concise instruction material on the method of potting connectors for the purpose of sealing against moisture are included in the 12-page, 2-color bulletin PM-1. Such items as ways to mix the sealant, potting forms, types of guns and various required time intervals are discussed in detail. Also included are both the resilient and plastic insert potting connector types with complete dimensional data to latest BuAer specifications.

Microminiature Relay. General Electric Co., Schenectady 5, N. Y. The 4-page bulletin, GEA-6346, covers a new microminiature relay and lists specifications for both the standard and the current-sensitive models. The hermetically sealed relay described weighs 0.35 oz in the standard model and 0.4 oz in the current-sensitive model.

Electrical Tachometers. Weston Electrical Instrument Corp., 614 Frelinghuysen Ave., Newark 5, N. J. Catalog D9A gives complete details on the new, simplified bearingless tachometer generators, as well as complete information on all Weston a-c and d-c voltage responsive and frequency responsive tachometer systems. It also illustrates and describes the types and sizes of indicators, recorders and tachometer generators available, together with dimensional diagrams and helpful mounting information.

Regulated D-C Power Supply. Lambda Electronics Corp., 103-02 Northern Blvd., Corona 68, N. Y. A recent folder illustrates and describes a 1.5-ampere regulated d-c power supply series. Included are a models and price list, specifications and a check list of the company's other power supplies.

Servomechanism Components. Norden-Ketay Corp., 555 Broadway, New York 12, N. Y. Bulletin No. 362 is an 18-page pocket-size manual of rotating servomechanism components, and adjustment and setting tools. Dimensional drawings and specifications are included.

Environmental Testing Facilities. American Electronic Laboratories, Inc., 641 Arch St., Philadelphia 6, Pa. A 4-page brochure outlining

services supplied is now available. Complete facilities are described including tables of parameters measured, range of measurement and accuracy of measurement.

Ceramic Capacitors. Solar Mfg. Corp., East 46th St. and Seville Ave., Los Angeles, Calif. A new catalog gives application data, capacitance-per-size designations, specifications and curves for a complete line of ceramic capacitors. The line described includes disk types in by-pass, h-v, temperature-compensating and special styles; feedthrough and trimmer types, and tubular types in bypass and temperature-compensating styles. An extensive line of printed networks is catalogued, together with data on piezoelectric elements. Also included is a simplified style designation system for use in ordering. Requests for the catalog should be sent on company letterhead.

Flexibility of Temperature Controls. Minneapolis-Honeywell Regulator Co., 2753 Fourth Ave. South, Minneapolis 8, Minn. How the flexibility of electronic temperature controls makes them useful in a wide range of commercial heating and air conditioning installations is explained in a new booklet. The four basic features that give electronic control its flexibility and application to a wide variety of installations are described and illustrated. Included are (1) a wide choice of methods of thermostat operation including remote adjustment from a single central panel; (2) convenient, efficient and economical sequencing of heating and air conditioning equipment operation to meet varied requirements; (3) easy location of control components for maximum efficiency regardless of shape, size and number of zones in the system and (4) speedy and efficient compensation of thermostats to meet the rapid and widely fluctuating load changes characteristic of most commercial buildings.

Glass Sealing Alloys. Superior Tube Co., 1523 Germantown Ave., Norristown, Pa. Glass sealing tubing made from constant or uniform expansion alloys is described in data memorandum No. 15. The



New!

**"P" TYPE
ENCAPSULATED
RESISTORS**

Stable... Small... Light-weight...

Shallcross "P" Type Encapsulated Resistors are ideal for installation where stability, dependability, and minimum size and weight are a must. These radically new resistors offer the performance advantages of hermetically-sealed steatite resistors at less cost.

Because of the unique Shallcross method of encapsulating windings, "P" type resistors have greater maximum resistances, longer leakage paths, and higher wattage ratings.

Shallcross "P" type resistors are available in six MIL-R-93A lug-type styles and five axial lead styles with wattage ratings ranging from .500 to 3.5 watts. All styles meet and exceed JAN-R-93A, Characteristic A.

Complete information on sizes, ratings, and test results of Shallcross "P" type precision wirewound resistors is available in Engineering Bulletin L-30. Write for your copy today.

SHALLCROSS MANUFACTURING CO.
522 Pusey Avenue, Collingdale, Pa.

Shallcross

NOW... you can get a quick-acting quarter-turn Lion Fastener for every need!

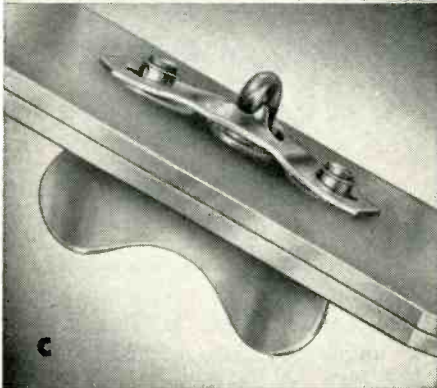
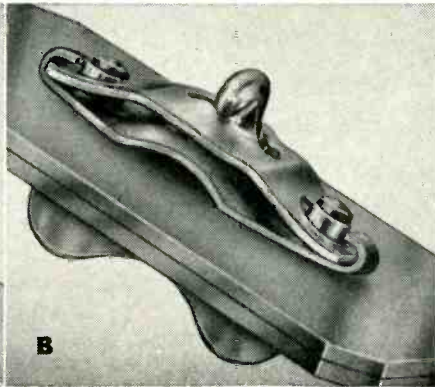
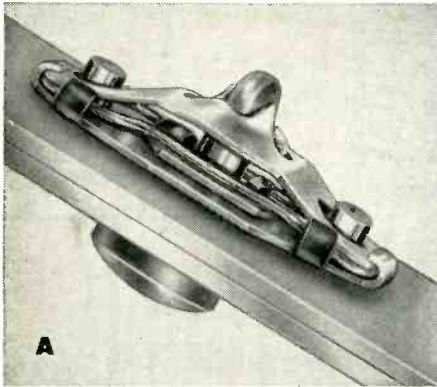

- (A) LION HI-STRENGTH WITH HIGH SHEAR LOAD
- (B) LION NO. 5 MADE TO 1" CENTER
- (C) LION NO. 2 MADE TO 3/4" CENTER

Lion fasteners give you strong, vibrationproof, positive locking for plastic, plywood or metal parts which must be removed repeatedly for inspection, maintenance, etc. Patented Lion cantilever spring-locking designs team fast access with absolute safety.

Hi-Strength fastener—takes shear loads up to 4700 lbs. Designed for rugged applications requiring great fastener strength. Takes up no more room than a No. 5 fastener.

No. 5 fastener—recommended for panels and inspection doors where long life must be combined with easy access.

SEND FOR FREE LION DEMONSTRATOR KIT

Tell us the size and type you are interested in seeing, and we will send you a kit in which there is a mounted working model and unmounted components. A request on your letterhead will bring it to you. Write today.

No. 2 fastener—used mostly on small panels for electronic telephone and similar equipment. Also frequently used to hold small assemblies which must be removed as units for inspection or service.

Head styles—oval, flush, knurled, ring, notched, wing or to your design specifications.

Delivery—You can be sure of delivery on the date you specify. We stock over one million fasteners in standard sizes and finishes for same day shipment on most orders. Production facilities are almost always open for custom orders.

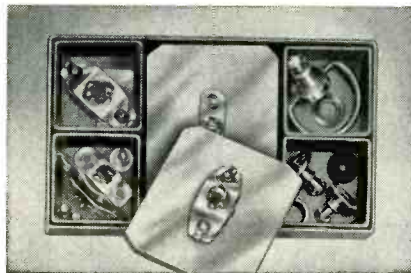

Southco Division
South Chester Corp
233 Industrial Highway
Lester, Pa.

LION Quarter-turn FASTENERS

one of the

SOUTHCO

FASTENERS

data cover 6 glass sealing alloys in standard production. Included in the data are production limits, nominal chemical analysis, temper ranges, mechanical properties, thermal properties and tolerances. A chart shows approximate expansion curves for the 6 standard alloys for temperatures from 0 to 1,000 F. The seals described are used increasingly to protect electronic components such as transistors, capacitors, voltage regulators and meters from humidity, industrial atmospheres or to pressurize these components for high-altitude service.

Testing Instruments. Amthor Testing Instrument Co., 45 Van Sinderen Ave., Brooklyn 7, N. Y., has available a catalog illustrating and describing tensile testers, pressure gage testers, tachometers, thickness gages, speed indicators, mercury column pressure and vacuum gages, bursting strength testers, cordage and paper scales.

Boron Carbon Precistors. International Resistance Co., 401 North Broad St., Philadelphia 8, Pa. A 4-page bulletin (B-6a) contains comprehensive data on types, construction, applications, performance, temperature coefficient, tolerance, insulation, and terminations of 1/2, 1 and 2-watt boron carbon precistors. Detailed charts and graphs are included.

Encapsulated Resistors. Cinema Engineering Co., Division of Aerovox Corp., Burbank, Calif., has issued a 20-page catalog, insert size, covering its encapsulated resistor line. Illustrated are both the CE100 and CE 200 series for axial wire terminals, radial wire terminals and radial lug terminals. The PW100 series and PW200 series are for printed circuitry. Dimensional detail, wattage ratings, maximum resistance and military equivalents are stated. Ask for bulletin LC-1030-A.

Tape Resistors. Hansen Electronics Co., 7117 Santa Monica Blvd., Los Angeles 46, Calif. "Tape Resistors and their Application to Miniaturization" is the title of bulletin HEC-1. The brochure describes tape resistors, gives their char-

acteristics and discusses design considerations affecting printed circuitry and miniaturization.

Tube Curve Work Sheets. Technical Publishing House, P.O. Box 61, Waltham 54, Mass. Vacuum-tube circuit design is made easier and faster by use of new large tube curve work sheets. The curves, on 8½ by 11 in. pads, show plate characteristics, positive-grid characteristics, plus screen characteristics for pentodes. For ease of reading numerical data, all graph scales have been standardized at 1, 2 or 5 units per scale division. Reliable design is assured by limits of maximum voltage, current, and dissipation being clearly marked on the curves. A sample sheet of any of the 15 tube types available will be sent upon request.

Magnetic Servo Amplifiers. Feedback Controls, Inc., 1332 North Henry St., Alexandria, Va. Six magnetic servo amplifiers and output stages are illustrated and described in an 8-page booklet, 101 8/55. Features, applications, specifications and dimensional diagrams are included.

Ceramic Magnets. The Indiana Steel Products Co., Valparaiso, Ind. The characteristics, design and application of Indox I—a lightweight, low-cost nonmetallic ceramic permanent magnet—are described in a new, 4-page catalog. Catalog 15 shows how the light weight and high coercive force of the magnet make it especially suitable for indicating gages, magnetic couplings, magnetic filters, special instrumentation and miscellaneous holding applications. The high coercive force described also makes it well adapted for generators, motors, tv focusing units, polarized relays, and in applications where the magnetic length is limited or magnetization prior to assembly is necessary. The catalog also describes the manufacturing processes involved and lists the types of Indox magnets available for experimental purposes.

Potentiometer and Variable Auto-transformer. The Perkin-Elmer Corp., Norwalk, Conn. A 4-page brochure describes features, design principle and specifications of the

Adjustable **LARGE CAPACITANCE** **TO CLOSE TOLERANCE**

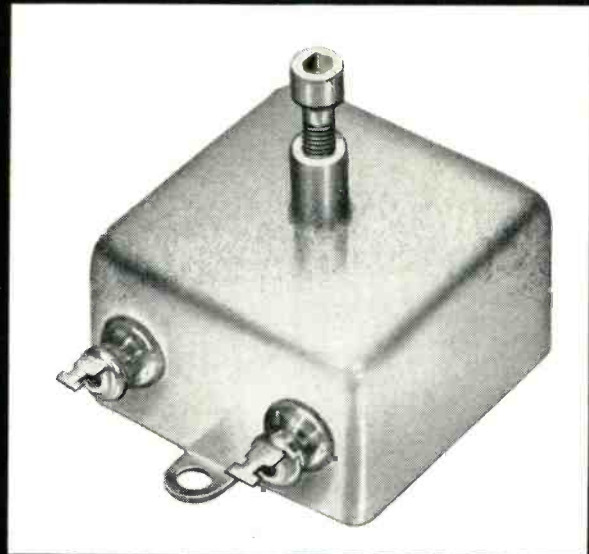

Available in one hole mounting for operation through front panel or chassis top.

Adjustable

POLYSTYRENE CAPACITORS by **fci**



— for ultra-precise circuits where capacitance cannot be predicted in advance due to second order effects. Capacitance is adjustable over a range of 1% of nominal value. Change of capacitance is instantaneous with the adjustment, and is linear with the rotation of the adjustment screw to better than 0.25%. Once set, capacitance is maintained within 0.1% for approximately one year. Adjustments in the original setting can be made with extreme accuracy, because the unit will track its own curve for months after setting. Standard values are 0.1, 0.25, 0.50, and 1.00 mfd. Other values supplied to order. Adjustable Teflon capacitors also available.

ELECTRICAL CHARACTERISTICS*

RATED VOLTAGE.....	200 DC
TEST VOLTAGE.....	500 DC
POWER FACTOR.....	0.02%
SOAKAGE, etc.....	0.01-0.02%
INSULATION RESISTANCE.....	10 ⁴ meg/mfd @ 20°C.
OPERATING TEMPERATURE.....	-40°F. to +160°F.
TEMPERATURE COEFFICIENT.....	-100 ppm/°C.

*For complete technical data, write for catalog

fci

film capacitors, inc.

3400 Park Ave., New York 56, N.Y. • Phone CYpress 2-5180

SAVE PRODUCTION TIME! CUT INSPECTION COST

WITH THE NEW

LINK 209 CABLE CHECKER

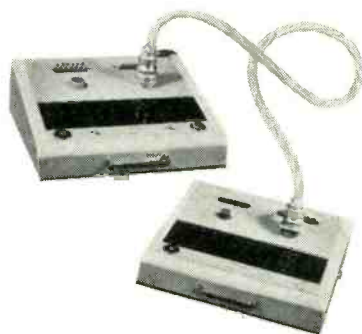
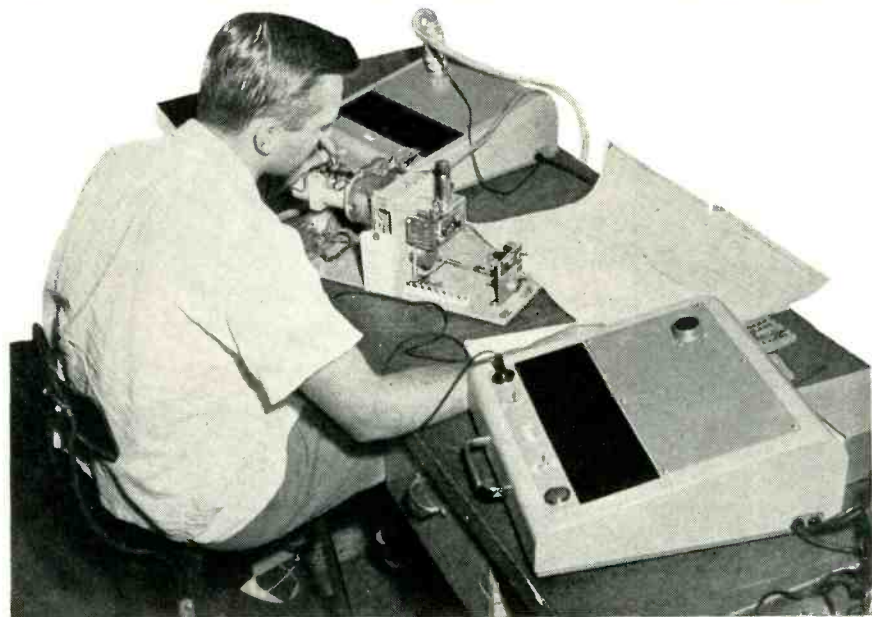

- ✓ *Positive visual indication!*
- ✓ *Only one test probe needed!*
- ✓ *Easy to operate—no technical experience needed!*
- ✓ *Minimum set up time—
for any operation!*
- ✓ *Rugged, durable—
maintenance-free!*

Let the versatile Link 209 Cable Checker save you time and money in assembly and inspection. This new production tool will cut your assembly and inspection costs—slash inspection time by as much as one-half!

The new Link 209 Cable Checker is portable, compact and easy to operate—a fool-proof tool that simplifies continuity testing—finds shorts, opens and grounds—all in one simple operation.

\$575.00

At the low price of
Write Dept. E today for additional details.

LINK
AVIATION, INC.

BINGHAMTON, NEW YORK

A SUBSIDIARY OF
GENERAL PRECISION
EQUIPMENT CORPORATION



NEW PRODUCTS

(continued)

400-cycle Vernistat for use in servo systems and analog computers. The device discussed (combining the best features of an a-c potentiometer and a variable autotransformer) relates mechanical shaft rotation to electrical voltage. It is designed to the BuOrd specifications for a size 18 synchro.

Precision Mechanical Springs. The Reliable Spring and Wire Forms Co., 3167 Fulton Rd., Cleveland 9, Ohio. A 24-page 2-color, profusely illustrated brochure, contains facts on manufacturing methods, facilities, processes, ranges and applications of springs in modern manufacturing. It describes methods for specifying correctly and offers suggestions on the selection of spring sources. The brochure illustrates the method for integrating spring manufacturing with the users' own production. It describes quality control procedures, and explains research and development activities.

Thermocouple Connectors. Minneapolis-Honeywell Regulator Co., Wayne and Windrim Aves., Philadelphia 44, Pa. Specification sheet 56 describes A-N thermocouple connectors. The connectors described provide a quick and easily detachable connection for one or more thermocouple circuits. They consist of mating plug and receptacle assemblies, keyed to prevent incorrect assemblies. Their particular usefulness is in test assemblies and for panel boards which are set up for semipermanent use.

Crystal Diode Manual. CBS-Hytron, a division of Columbia Broadcasting System, Inc., Danvers, Mass. Bulletin E-217 is the second edition of the company's crystal diode manual. Revised and brought up to date, the new edition includes germanium and silicon diodes, glass encased and plastic encased. The profusely illustrated manual contains 3 parts: (1) Construction and advantages; (2) electrical and mechanical data; (3) selection and application.

Products and Facilities. Inland Testing Laboratories, 1457 W. Diversey Parkway, Chicago, Ill., has issued a new 40-page brochure. It describes in detail the qualifications, personnel, equipment and

facilities available at Inland for a wide range of products and systems testing and evaluation and other testing services available to industry and government agencies.

Induction Heater. Westinghouse Electric Corp., P. O. Box 2099, Pittsburgh 30, Pa. Bulletin 85-875 describes the 30-kw induction heater for the metal-working industry. Applications of the induction heater are suggested. In addition to complete control and output facilities, a description of the work station housing for all components such as output transformers, capacitors, contactors and timers is presented.

Servoscope. Servo Corp. of America, 20-20 Jericho Turnpike, New Hyde Park, L. I., N. Y. A 6-page folder describes industrial applications, outstanding features, advantages and specifications for a multiple signal generator with various signal outputs. The Servoscope described provides the user with a direct method of comparing the gain and phase shifts of a servo system, component or l-f network; and is applicable to a-c carrier and d-c servo systems. The four models discussed offer frequency ranges from 0.001 to 60 cps. Each generates three types of signals: sine-wave modulated carrier, l-f sine waves and l-f square waves.

Sensitive Relays. Hedin Tele-Technical Corp., 87 Dorsa Ave., Livingston, N. J., has published literature featuring three new sensitive relays incorporating sensitivity with a thorough wiping effect. The relay 100 operates 25 million times with no fatigue or deterioration. The relays described are designed particularly for chassis with space limitations. The literature points out that drop-out can be adjusted to 65 percent of pickup; contact combinations are from spst to dpdt; and pure silver contacts are used. Complete technical specifications may be found in the literature discussed.

Industrial Enclosed Switches. Micro Switch, a division of Minneapolis-Honeywell Regulator Co., Freeport, Ill. Published as an aid to the plant engineer and maintenance man, as well as the de-

USE VICTOREEN HI-MEG RESISTORS WHERE ACCURACY AND STABILITY ARE ESSENTIAL

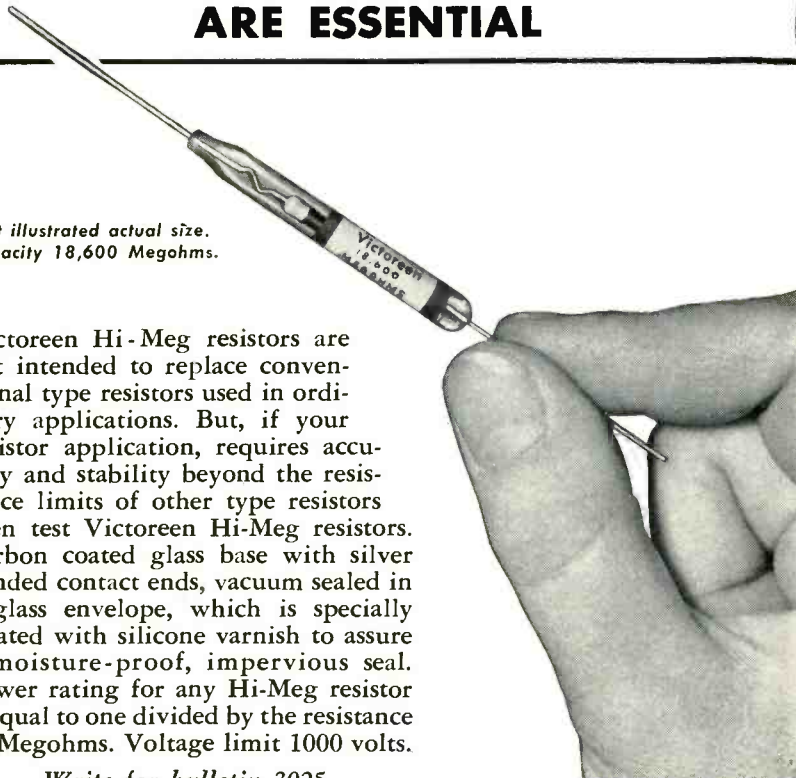

Unit illustrated actual size. Capacity 18,600 Megohms.

Victoreen Hi-Meg resistors are not intended to replace conventional type resistors used in ordinary applications. But, if your resistor application, requires accuracy and stability beyond the resistance limits of other type resistors then test Victoreen Hi-Meg resistors. Carbon coated glass base with silver banded contact ends, vacuum sealed in a glass envelope, which is specially treated with silicone varnish to assure a moisture-proof, impervious seal. Power rating for any Hi-Meg resistor is equal to one divided by the resistance in Megohms. Voltage limit 1000 volts.

Write for bulletin 3025.

AVERAGE VOLTAGE COEFFICIENT OF HI-MEG RESISTORS VERSUS RESISTANCE

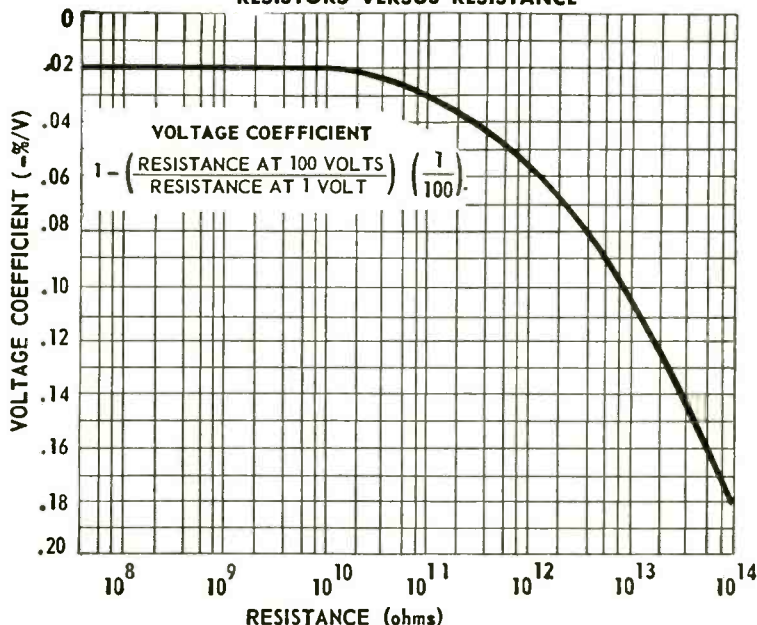

COMPONENTS DIVISION



The Victoreen Instrument Co.

3810 PERKINS AVE. • CLEVELAND 14, OHIO

5

**IMPORTANT
REASONS
WHY YOU
SHOULD
SPECIFY**

**RESINITE
COIL FORMS**

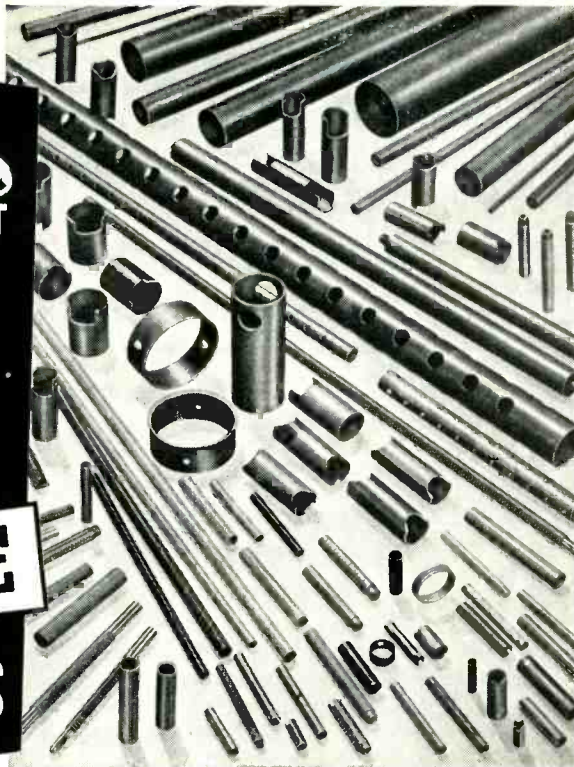

1. **RESINITE AC** combines all the mechanical and dielectric advantages of phenolics with the high dielectric strength, moisture resistant and non-corrosive properties of cellulose acetate.
2. **RESINITE 104** is a tough material suitable for stapling, severe forming and fabricating.
3. **RESINITE 8104** minimizes the effects of electrical property degradation characteristic of laminated phenolics when subjected to high humidity and temperature.
4. **RESINITE TruTork** provides an internally threaded or embossed form to fit any threaded core, regardless of diameter or threads per inch.
5. **RESINITE** gives torque control of plus or minus 1 inch ounce—axial pressure in excess of 25 pounds.

Ask us how you can save money by replacing expensive plastics with low-cost Resinite tubes for many applications involving high chemical or moisture conditions.

Get full information on Resinite Coil Forms. Request detailed technical literature.

RESINITE CORPORATION

Sales Representatives in:

New England: Framingham, Massachusetts, Trinity 3-7091

Metropolitan New York, New Jersey:

Jersey City, New Jersey, Journal Square 4-3574

Upstate New York: Syracuse, New York, Syracuse 4-2141

Northern Ohio, Western Pennsylvania: Cleveland, Ohio, Atlantic 1-1060

Indiana, Southern Ohio: Logansport, Indiana, Logansport 2555

California: Pasadena, California, Sycamore 8-3919

Canada: Montreal, Quebec, Canada, Walnut 0337

Division of

PRECISION PAPER TUBE COMPANY

2035E W. CHARLESTON ST. • CHICAGO 47, ILLINOIS

NEW PRODUCTS

(continued)

signer of original equipment, the 28-page catalog 83 describes in detail the wide variety of enclosed switches which are designed for use on either a-c or d-c industrial applications. Included are general purpose switches, sealed switches, heavy-duty limit switches, hand operated switches and maintained-contact switches, all of which are available in a variety of actuator designs, contact arrangements and electrical ratings. Catalog 83 is complete with photographs, dimension drawings, circuit diagrams, electrical data and technical information. In all, 90 different switches are covered.

High-Voltage Resistors. International Resistance Co., 401 North Broad St., Philadelphia 8, Pa. Bulletin G-1a contains 8 pages of comprehensive data on construction, specifications, installation, tolerance, voltage coefficient, temperature coefficient, ratings, insulation and terminations for the type MV high-voltage resistors. Detailed charts and graphs are included.

Kits & Complete Instruments. General Electronic Equipment Co., P.O. Box 347, Easton, Pa., has announced a new two-color brochure describing the new line of kits and complete instruments that are available. The bulletin includes oscilloscopes, tube testers, Geiger counters and multitesters.

Insulating and Jacketing Materials. E. I. DuPont deNemours & Co., Inc., Wilmington 98, Delaware. Number WC-1, first of a series of bulletins covering insulating and jacketing materials for wire and cable, deals with the properties of the products of the Polychemicals Department. The second bulletin will be concerned with wire coating techniques as they apply to these materials. Subsequent bulletins will deal with the other aspects of the field of wire coating and utilization.

Infrared Spectroscopy. Beckman Division, Beckman Instruments, Inc., Fullerton, Calif. Reprints of an informative article surveying the usefulness of infrared spectroscopy as a research and development tool in the industrial labora-

tory are now available. The authors touch on the behavior of compounds absorbing infrared energy, present a number of infrared spectra showing characteristic absorption bands of various compounds and outline the many possible infrared applications.

Strip-Chart Recorders. The Bristol Co., Waterbury 20, Conn., has released a bulletin describing a line of 6-in. strip-chart recorders for pressure, liquid level, temperature, flow and mechanical motion. The 12-page, 2-color bulletin contains installation drawings showing methods of applying the instruments to the different variables, as well as photographs of the various models and their features. Use of the recorder as a receiver for remotely generated signals is also described.

Direct - Reading Spectrometers. Baird Associates, Inc., 33 University Road, Cambridge 38, Mass. Bulletin No. 44 provides a detailed description of improved model direct-reading spectrometers featuring the automatic servo monitor. Operation and construction of direct readers are outlined in an 8-page bulletin with diagrams and photographs. The completely automatically operated monitor described keeps the optical system in alignment at all times. Another feature is the logarithmic calibration of clock indicators directly in percent concentration. The bulletin gives an engineering treatment of the instrument and is accompanied by a file folder which describes economic advantages.

Silicon Junction Diodes. Hughes Aircraft Co., Culver City, Calif., has available an illustrated 8-page bulletin S P-4, which lists and describes silicon junction diodes types HD6001, HD6002, HD6003, HD6005, HD6006, HD6007, HD6008, and HD6009. The bulletin contains specifications and characteristics of these subminiature devices, which are fusion-sealed in glass, and have an ambient operating temperature range of from -80 to +200 C.

D-C Temperature Bridges. Leeds & Northrup Co., 4934 Stenton Ave.,

Phase Measurement

IN
QUALITY CONTROL

BELL AIRCRAFT USES
TIC'S
DIRECT READING
PHASE METERS



MAGNETIC
MODULATOR
BIAS

Operating bias in magnetic modulators accurately set with TIC's Type 320-AB Phase Meter. Modulators are in helicopter vertical height control computers.

to speed production and unit inspection in the Buffalo, New York, plant.

Adjustments and performance tolerance limits are quickly and accurately established by Bell's production personnel with TIC's Phase Meters for on-the-line inspection of:

RESONANT FREQUENCY

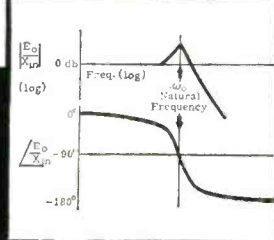

Resonant frequency of accelerometers measured with TIC's Type 322-A Phase Meter. Meter locates frequency that produces 90° phase shift between electrical output and mechanical input. Steepness of phase curve at resonance, makes this method much more accurate than determining frequency yielding highest output amplitude.

INITIAL SYNCHRO PHASE SHIFT

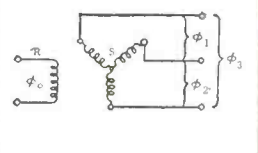

Inherent phase shift between rotor and stator winding of synchros must be determined and held rigorously within small tolerances. Phase shift is displayed on TIC Type 320-AB Phase Meter.

AUTOPILOT AMPLIFIERS



Autopilot amplifier phase shift measured and adjusted to exacting tolerances with TIC's Type 320-AB Phase Meter. Amplifiers control helicopter roll, pitch, yaw and vertical height.

SYNCHRO PHASING



Helicopter Autopilot Gyro Table Assembly undergoes precise synchro phasing and connection identification. Assembly is quickly checked on a calibrated positional test table with 320-AB Phase Meter.

TIC'S PHASE METERS

DIRECT READING TIC Phase Meters permit production-line testing of vital phase characteristics. Phase meters can be used for sine wave or for complex wave inputs having one positive going zero-axis crossing per cycle. Write for free brochure I-104 for data on TIC's complete line of phase instruments.

TECHNOLOGY INSTRUMENT CORP.

533 Main Street, Acton, Mass. Colonial 3-7711
West Coast Plant — Box 3941, No. Hollywood, Calif. Poplar 5-8620

**OVER 100
MISSOURI
COMMUNITIES SAY:**

*"Let us 'tailor-make'
a plant and
more opportunity
for you!"*



Yes, you can write your own ticket in Missouri . . . your choice of industrial buildings listed in the latest "Missouri Quarterly Available Buildings Report"; your choice of twenty cities, large and small, which are ready and able to *tailor-make* your plant to your plans in "Organized Industrial Districts"; your choice of over 100 other communities willing to organize, acquire sites and build for you!

And Missouri doesn't send you . . . Missouri goes with you to the plants and the people in your own private exploration tour!

This personal, confidential service is the "extra ingredient" in Missouri's "Tailor-Made Industry Plan" which, exclusive of big national industry expansions, helped locate and build new plants totaling \$136,000,000 in the "show me state" last year. And Missouri is rich in power, oil pipelines, gas, coal, industrial water, chemicals, minerals, forests, agriculture and recreation for good living and top production. Its unrivaled road, rail and water network make Missouri the crossroads of America.

But the biggest bonus Missouri offers is its different "Tailor-Made Industry Plan", which prepares the right community for the plant . . . then builds the plant to your plans! It will pay you to let Missouri show you first. For complete, confidential exploration,



**PHONE COLLECT—
Jefferson City 6-7185**

or write Dept. K592
Lisle Jeffrey, Industrial Engineer
Missouri Division of
Resources & Development
Jefferson City, Missouri

NEW PRODUCTS

(continued)

Philadelphia 44, Pa. Complete information about bench-type and portable d-c temperature bridges for temperature and temperature difference measurements of moderate accuracy by the resistance thermometer method is now available in an illustrated 2-page data sheet. Data sheet E-33(2) describes the construction of each bridge, diagrams the circuit, and lists specifications and accessory equipment.

Miniature Ball Bearings. Miniature Precision Bearings, Inc., Keene, N. H. A 24-page booklet covers a line of 513 standard miniature precision radial bearings tabulated according to bore size. The relatively high load capacity and resistance to shock of the bearings described make them particularly suitable for applications in which jewel pivots cannot be used because of low physical strength. Information on special bearings and their applications, as well as the company's services, is included.

Airborne Assemblies. Electronic Specialty Co., 5121 San Fernando Road, Los Angeles 39, Calif. A new engineering design catalog lists voltage sensing devices, timers and time delay relays, flashers, and special aircraft devices, test equipment and miniature components. The airborne assemblies described are for use where precision and dependability are essential. Forty-eight installation drawings are provided, plus specifications for each item.

Receiving-Type Tubes. Radio Corp. of America, Harrison, N. J. A 20-page booklet (Form No. RIT-104) contains technical data on 130 small industrial tubes including Special Red tubes, premium tubes, pencil-type tubes, computer tubes, glow-discharge tubes, small thyratrons, low-microphonic amplifier tubes, and other special types. In addition, a chart is included listing RCA types intended for government end use only. Each tube type except those in the latter group is covered by a text description, tabular data, and a base or envelope connection diagram. Representative tube types are illustrated. The booklet is priced at \$0.20 per copy.

**TEST
CHAMBERS**

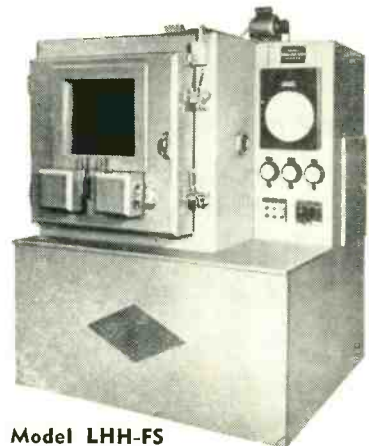

**Model LHH-FS
Low-High Temperature Chamber
with Controlled Humidity**

Supplied in sizes from 2 to 100 cu. ft. net working space, these chambers operate to -100° F at rapid reduction rate and provide controlled humidity through a range of 35 to 175° F at 20 to 95% r.h. Full controls available.

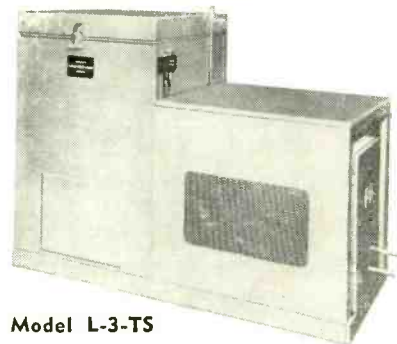

**Model L-3-TS
Chest Type Low-Temperature Cabinet**

Available in sizes from 2 to 30 cu. ft. net working space. Optional controls furnished to customer specifications. Temperature range to -100° F. Capacity for rapid temperature reduction.

Equipment available to meet U. S. Govt. specs for environment testing. Electronic or pneumatic recording or indicating control systems. Walk-in rooms, temperature baths and custom chambers manufactured to specifications. Optional finishes in hammertone, aluminum or stainless steel. Rounded corners standard on all equipment.

**WALK-IN ROOMS
TEMPERATURE BATHS**

Manufacturers of Environmental
Test Equipment Since 1941
MEMBER of Environmental Equipment
Institute



**55 Washington Avenue
Carlstadt, New Jersey
Geneva 8-1500**

YOU CAN PROFIT

with the **BEAD CHAIN**
ECONOMICAL
MULTI-SWAGE
METHOD



this
FREE
catalog
can help
you to...

LOWER PRODUCTION COSTS on Tiny Metal Tubular Parts

Bead Chain's exclusive multi-swage method automatically swages almost any type of tiny metal tubular part from flat stock into precision forms with positive, tight seams. High-volume production can be delivered speedily and at far less cost than with conventional methods of manufacture! Parts can be beaded, grooved, shouldered and made of almost any metal. Diameters up to 1/4", lengths to 1 1/2"



WRITE
TODAY!

**THE BEAD CHAIN
MANUFACTURING CO.**

88 Mountain Grove St., Bridgeport, Conn.

FULL LINE MINIATURE COMPONENTS

SIZE 11 FRAME



SIZE 11 400 ~ Motor Tachometers (Drag cup type tachometer)

Tachometer input: 115 v
Tachometer output: 500 mv/1000 rpm.
Linearity: $\pm 1\%$
Phase shift: 10° max.
Maximum total null voltage: 19 mv.
Motor input: 115 v fixed phase
115/57.5 v control phase
Stall torque: 0.63 oz in.
No load speed: 5900 rpm.

Separate motors or tachometers available with the same or different operating characteristics.



SIZE 11 400 ~ Induction Generators

Excitation: 115 v 400 ~
Voltage output: 1.25 v/1000 rpm.
Linearity $\pm 1\%$ up to 6000 rpm.
Maximum total null voltage: 60 mv
Phase shift: under 5°
Moment of inertia: 1.1 gm cm²

Damping generators with other characteristics available.



SIZE 11 400 ~ Resolvers

High or low impedance Models
Network or winding compensated
Electrical equivalent to Mark 4 Mod. 0
Functional error: under 0.1%
Interaxis error: under ± 5 min.
Input voltage: up to 60 v at 400 ~
Other frequencies available

SIZES 15, 18
and
23 Frames
also
available

SERVO MOTORS, GEARED SERVO MOTORS,
MOTOR TACHOMETERS, BRUSHLESS
INDUCTION POTENTIOMETERS,
MINIATURE SYNCHRONOUS MOTORS;
low and high temperature models.

American Electronic Mfg., Inc.

INSTRUMENT DIVISION OF



9503 W. JEFFERSON BLVD., CULVER CITY, CALIF.

Engineering Representatives in all Principal Industrial Areas

YOKES

Industrial Camera
Yokes
Alignment Yokes
Image Orthicon
Yokes
Focus Coils Image
Orthicon
Terminal Board
Assemblies

COILS

Variable R.F.
Variable I.F.
Plate Coils
Oscillator Coils
Crystal Heater Units

COIL ASSEMBLIES

Impedance Coils
Peaking Coils
R.F. Chokes
Video Peaking Coils
Transmitter Coils

TELE COIL CO., Inc.

SAMUEL FELDMAN, Pres.

2733 Saunders St.

Camden 5, N. J.

Phone EMerson 5-7528

WE CARRY IN STOCK ALL SIZES, ALL SHAPES, ALL ALNICO GRADES

When you
need them—
as you need them . . .

HIGH ENERGY, PRECISION
ALNICO PERMANENT **MAGNETS**

Experimental or
production
quantities



PERMAG

ENGINEERING
PRECISION CUTTING
PRECISION GRINDING
MAGNETIZING

Catalog upon request

PERMAG CORP., 210 TAAFFE PLACE, BROOKLYN 5, N. Y. — Phone: MAin 2-0114

Plants and People

Edited by WILLIAM G. ARNOLD

Technical societies select electronic engineers to receive honors and awards. More manufacturers plan facility expansions by acquisitions or new construction. Top engineers move to new positions of responsibility in the industry

Sylvania Makes Ten Millionth TV Tube, Plans English Plant

SYLVANIA Electric Products has produced a total of 10 million tv picture tubes.

The ten millionth tube—a 24-inch aluminized tube—was produced at the firm's Seneca Falls, N. Y. plant.

The company recently expanded its total domestic manufacturing space for picture tubes to 800,000 sq ft. Last fall it built a West Coast tube plant.

Don G. Mitchell, president and board chairman of Sylvania, announced that the company plans to form a picture tube firm in England in conjunction with Thorn Electrical Industries.

The new company, which would make only black-and-white tubes, is to be jointly financed by Thorn and Sylvania. A capital investment of several million dollars is planned. Probable name for the firm will be Sylvania-Thorn Cathode Ray Tubes, Ltd.



Watching production of 10,000,000th tv picture tube at Sylvania are, left to right: W. C. Toner, plant manager; M. D. Burns, vice-president of operations; D. G. Mitchell, chairman and president and W. H. Lamb, divisional general manager

Initial output is estimated at more than one-half million tubes a year.

The tubes will be used for Thorn's

own make of television set, as well as for consumers in England and for export to other European and South American countries.

IRE Selects Hogan, Bullington, Hinman For Top Awards

JOHN V. L. HOGAN, president of Hogan Laboratories and founder of station WQXR, will be the recipient of the IRE Medal of Honor. The award is to be made "For his contributions to the electronic field as a founder and builder of the IRE, for the long sequence of his inventions, and for his continuing activity in the development of devices and systems useful in the communications art." It will be presented during the IRE National Convention in New York City next March.

He began his career in radio in 1906 as a laboratory assistant to Lee De Forest. From 1910 to 1921 he held posts with the National Electric Signaling Co. and the In-



John V. L. Hogan

ternational Radio Telegraph Company. He then became a consulting engineer in New York City. He is responsible for inventions in radio, television and facsimile fields. He was founder and owner of station WQXR, until it was acquired by The New York Times. He is president of Hogan Laboratories of New York City.

In 1912 he helped found the Institute of Radio Engineers, which has since grown to an international membership of over 43,000. He served as vice-president of the IRE from 1916 to 1919 and president in 1920. He has also served frequently as a member of the board of directors and on many committees of the

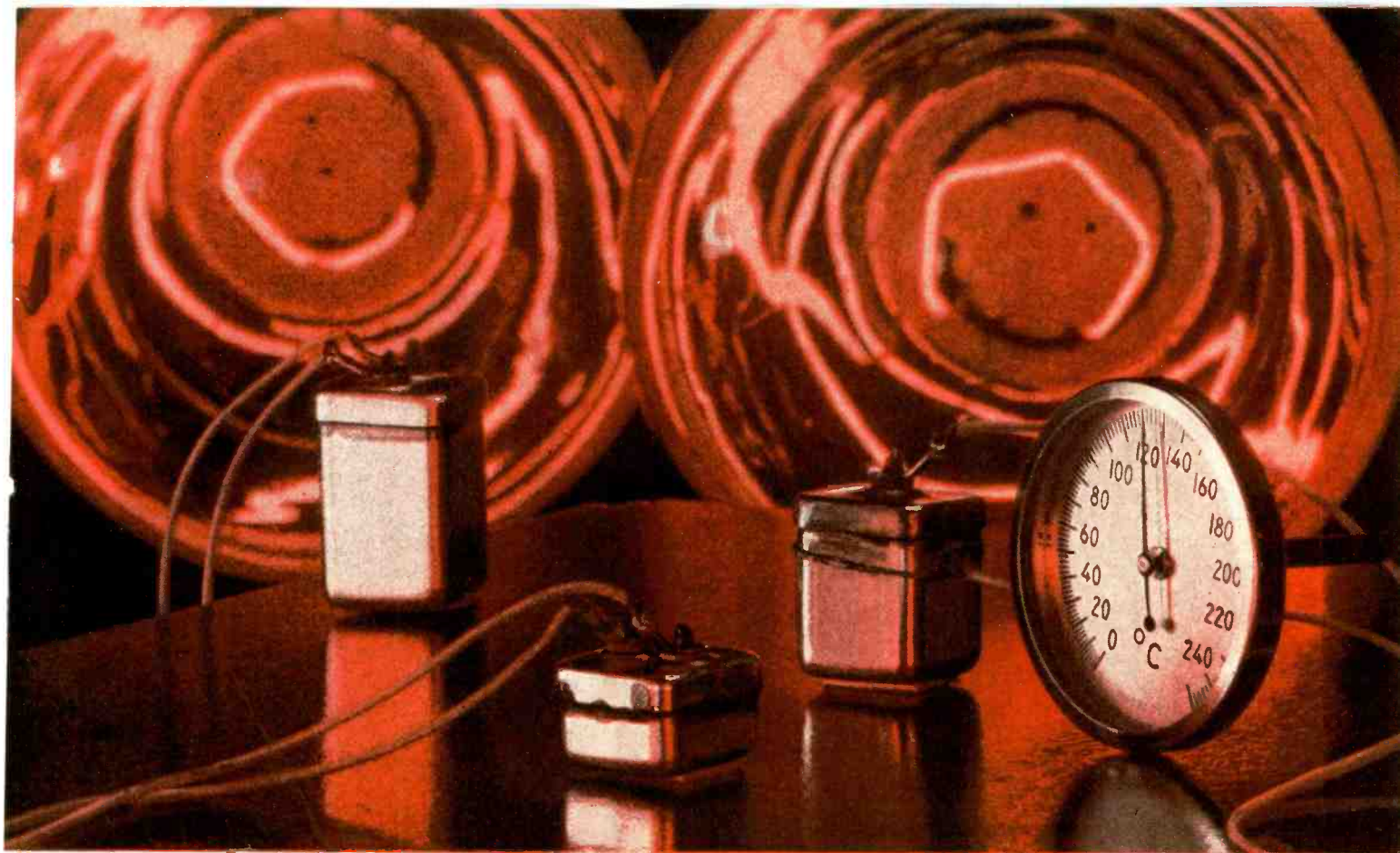

INFRA-RED LAMPS RAISE AMBIENT TEMPERATURE TO +125 C.

NEW G-E TANTALYTIC* CAPACITORS OPERATE AT +125°C AMBIENT

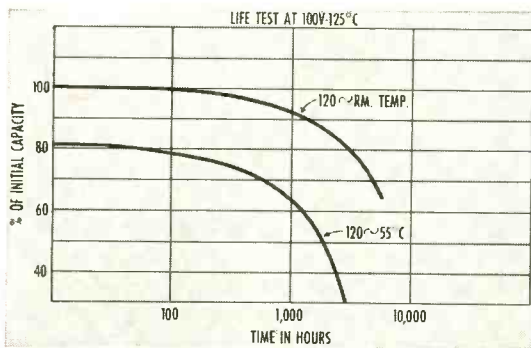

LONG LIFE of G-E high temperature Tantalitic capacitors is shown by this graph of life vs loss of capacitance for typical 100 volt d-c unit.

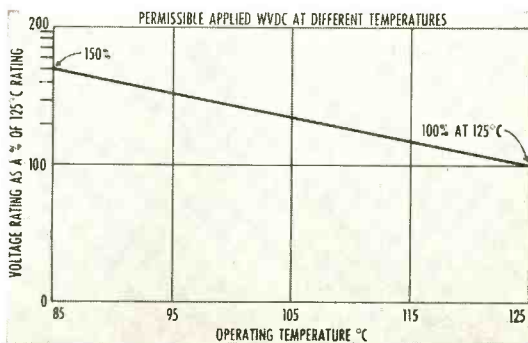

HIGHER VOLTAGES than 100 VDC can be applied . . . with no loss of life . . . at ambient temperatures below rated +125 C as shown above.

Available in ratings from 36 uf at 100 VDC to 180 uf at 30 VDC

Designed to operate at +125 C for 1000 hours with not more than 20% loss in initial +25 C capacitance, General Electric's new high-temperature Tantalitic capacitors meet the tough requirements of miniaturized military equipment.

FOIL CONSTRUCTION assures the same long life, high quality, and stable operating characteristics provided by +85 C Tantalitics. Unlike other types of Tantalitic capacitors, the foil construction also offers:

- Both polar and nonpolar construction.
- Chemically neutral electrolyte . . . minimizes corrosion danger.
- Excellent mechanical stability . . . freedom from electrical noise under shock and vibration.
- Excellent reliability at rated temperatures . . . extended life at temperatures below +125 C.

AVAILABILITY: G-E high-temperature Tantalitic capacitors can be obtained now in sample quantities for evaluation and prototype use. Production lots will be available by September in the following standard ratings:

Voltage	uf Case 1		uf Case 2		uf Case 3	
	3/4" x 3/4" x 1 1/8"	3/4" x 3/4" x 7/8"	3/4" x 3/4" x 7/8"	3/4" x 3/4" x 1/2"	3/4" x 3/4" x 1/2"	3/4" x 3/4" x 1/2"
30	180	110	110	55	55	55
50	100	60	60	30	30	30
75	60	36	36	18	18	18
100	36	24	24	12	12	12

For more information, see your G-E Apparatus Sales Representative or write for Bulletin GEA-6258, General Electric Company, Section 442-27, Schenectady 5, New York.

*Reg. trade-mark of General Electric Co.

Progress Is Our Most Important Product

GENERAL  ELECTRIC

industry's technical organization.

The Morris Liebmann Memorial Prize, awarded annually to an IRE member who has made a recent important contribution to the radio engineering art, is to be given to Kenneth Bullington of Bell Telephone Laboratories, New York, N. Y. "For his contributions to the knowledge of tropospheric transmission beyond the horizon, and to the application of the principles of such transmission to practical communications systems."

He joined Bell Laboratories in 1937 and since that time has been engaged almost entirely in studies relating to the propagation of radio waves. His work on scatter propagation during the last three years has been a major factor in extending communications.

Wilbur S. Hinman, Jr., director of the Diamond Ordnance Fuze Laboratories of Washington, D. C., will receive the Harry Diamond



Kenneth Bullington

Memorial Award, which is given to persons in government service for outstanding work in radio and electronics. The award will be given "For his contributions to the electronic art in the fields of meteorology and proximity fuzes."

He has been an important contributor to the development of air-



Wilbur S. Hinman, Jr.

craft navigation aids, radiosondes for obtaining information on upper-air weather, and in the development of the proximity fuze during World War II. He became director of the Fuze Laboratories which took over work on the proximity fuze from the National Bureau of Standards after the war.

William Shockley Joins Beckman Instruments

DR. WILLIAM SHOCKLEY has joined Beckman Instruments of Fullerton, Calif.

He comes to the firm from the Bell Telephone Laboratories, where he has been director of transistor physics research since 1954. He has been a member of Bell's research activity in various capacities since 1936.

He will build a new research group for Beckman, composed of scientists in the field, to work broadly toward the further development of semi-conductors.

Concerning his new position, Dr. Shockley said, "Beckman Instruments offers an unusual opportunity for attracting outstanding scientific personnel with the objective of building a compact group of men



William Shockley

who are interested in the most rapid progress possible of transistor and other semi-conductor research and development. This field is still in its

infancy. In Arnold Beckman I have found an industrial leader with a viewpoint thoroughly sympathetic to the kind of program which I wish to carry out. I feel, as does Dr. Beckman, that the contribution of transistors and other semi-conductor devices to automation will open a new era in which man is further freed from the limitations imposed on him by nature and many of the tedious necessities of this industrial age."

The transistor originally was developed during a program of solid state physics research at Bell Telephone Laboratories, which was carried out under Dr. Shockley's direction. In the course of this research program, Bell made an announcement in 1948 of the first transistor.

IT&T Builds \$2.5 Million Plant In California

IT&T will construct a new plant in Los Angeles, Calif. for its Federal Telephone and Radio Co. Representing an initial investment of over \$600,000 for land, building and equipment, the new plant will be constructed in five parts, at an ultimate cost of nearly \$2.5 million.

A line of electronic products, including power supplies and other devices particularly useful in aircraft manufacture, will be produced at the new plant.

All manufacturing will be on one floor with the office, laboratory and production areas occupying 36,000

sq ft of floor space in the initial section. It is situated on 13 acres.

It is IT&T's first factory on the West Coast. It was conceived with the purpose of enabling Federal to serve better the aircraft and other manufacturing industries.

(Continued on page 368)

*building
* large
transmitters?*

**
Combination MODEL A
and MODEL R blower
driven by Rotron's
new ultra-reliable
communications-type
L-FRAME motor.*



**ROTRON'S
CENTRALIZED COOLING** units
are efficient • rugged • reliable.
A single powerful motor
drives two different types of
blowers, each delivering air at a
different pressure level, covering
all transmitter cooling
air requirements.

COOLING EQUIPMENT FOR THE ELECTRONIC INDUSTRIES

*Rotron Manufacturing Co. and its
affiliate, Rotron Research Corp., render
engineering advice and laboratory
assistance. Discuss your cooling project
with Rotron at an early stage.*



ROTRON

MANUFACTURING CO., INC.
WOODSTOCK • NEW YORK

COOLING EQUIPMENT FOR THE ELECTRONIC INDUSTRIES

“
connectors?”



Certainly sir, I'll personally see they are sent you today.”

“
a small order?”



Wood's service is geared to meet your requirements, regardless of the size of your order.”

“
you're in a rush?”



That's easy, sir. Woods supplies the connectors you want, when you want them. We'll ship today.”

woods distributes only the finest lines

Authorized Distributor

- Cannon Plugs
- U. S. Relays
- Gremar R. F. Connectors

WOODS AIRCRAFT SUPPLY

"The Right Connection for the Right Connectors"

309 West Elmwood Ave., Burbank, California
Telephones: Victoria 9-3211
THornwall 2-8182

Byron Jackson Joins Borg-Warner

BYRON JACKSON, west coast manufacturer of pumps, oil tools and electronic equipment, has become the Byron Jackson division of Borg-Warner Corp.

Present management and policies will be continued. E. S. Dulin, president of Byron Jackson, has been named president of the new division.

Packard-Bell Elects Leng



RICHARD B. LENG has been elected to the newly created position of vice-president in charge of the technical products division of Packard-Bell Co.

He has had 20 years engineering and management experience in the electronics industry with Sylvania Electric, RCA and Raytheon. He joins Packard-Bell after resigning his post of manager of California operations for Sylvania Electric.

RCA Plans New Transistor Plant

A \$3 MILLION plant will be built by RCA's tube division in Bridgewater Township, near Somerville, N. J.

The new plant, which will be erected on an 83-acre plot beginning this fall, is expected to be ready for

- Low noise level
- Precision
- Stability

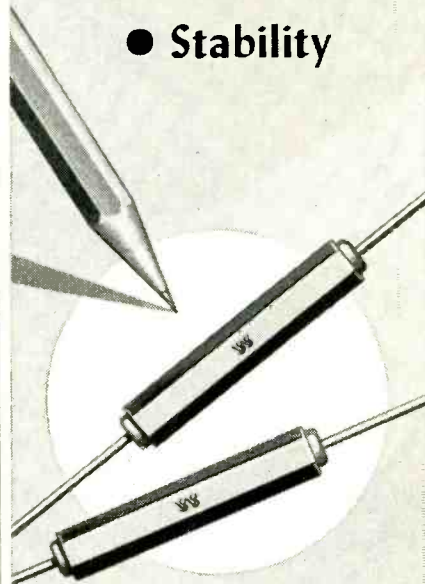

Sillwhite 65X
MOLDED RESISTORS

RATING—1 watt.

TEMPERATURE COEFFICIENT—From approx. +0.1%/°F for 5000 ohm values to approx. -0.2%/°F for 10 megohm values.

VOLTAGE COEFFICIENT—Rated at less than 0.02%/Volt.

UPPER TEMP. LIMIT—170°F for continuous operation.

NOISE LEVEL—Low noise level inherent, but at extra cost we can test and guarantee standard range resistors with "less noise than corresponds to a resistance change of 1 part in 1,000,000 for the complete audio frequency range."

VALUES

Standard Range—1000 ohms to 9 megohms.

Extra High Value Range—Up to 10,000,000 megohms.

BULLETIN 4906
has full details. Send for a copy. Attention Dept. R.



THE *Sillwhite* INDUSTRIAL DIVISION
DENTAL MFG. CO.

10 EAST 40th ST.
NEW YORK 16, N. Y.

Western District Office • Times Building, Long Beach, Calif.

operation by late 1956. It will serve as engineering and manufacturing headquarters for the semi-conductor activities of the division, providing facilities in addition to those in Harrison, N. J., for handling the demand for transistors and diodes.

The Bridgewater plant will have approximately 126,000 sq ft of floor space.

Loughlin And Olson Receive SMPTE Awards

THE SOCIETY of Motion Picture and Television Engineers named Bernard D. Loughlin as recipient of its 1955 David Sarnoff Gold Medal Award for his outstanding contributions to the field of color television. He is a consulting engineer with the Hazeltine Corp. in Little Neck, New York.

The award was established to give recognition to technical contributions to the art of television and is awarded primarily for achievements within the last five years. In 1954 it was presented to Ray D. Kell of RCA.

Loughlin has been with Hazeltine since 1939 in research and development. Two of his outstanding contributions noted by SMPTE are the understanding that the optimum method of transmitting a compatible color picture is by the transmission, by normal standards, of a black-and-white picture to which the color information is added; and the "constant luminance" principle, by which monochrome signal carries all of the luminance and the added color signals contribute only to chromaticity.

He is the holder of 36 patents, with 31 pending applications, and is the author of many technical articles. In 1952 he was awarded the Vladimir K. Zworykin Television Prize by the IRE.

The Society also selected Harry F. Olson of RCA as the recipient of its Samuel L. Warner Memorial Award for 1955.

The Warner Award is given to "a candidate who has done outstanding work in the field of sound motion-picture engineering and in the development of new and improved methods or apparatus de-

DEPENDABLE SWITCHES

Capitol dependable switches are used in: Electronic control panels, Computers, Television & Radio studios, Intercommunication systems, Alarm systems, Test equipment, etc.

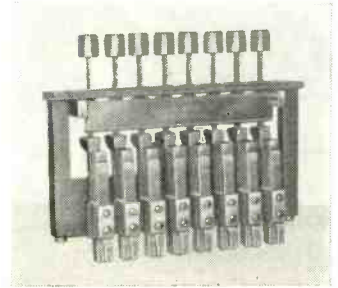

Capitol dependable multiple position push button switches are available with the following features:

- 3 to 14 positions (can be banked)
- Standard interlocking
- Momentary contact (non-locking)
- Positive lock-out
- Accumulative lock-up
- Illuminated

Capitol dependable switches are made of finest quality materials. All materials are non-corrosive. Contact springs are nickel silver with welded palladium contacts, rated at 3 amps.

Capitol also makes lever and single position push button switches

for further information on Capitol Switches and special applications write to:

The Capitol Machine Co.

Switch Division

36 Balmforth Ave.

Danbury, Conn.

—they're dependable!

DUKE
precision, deep drawn
KOVAR PARTS
—from 1/4" dia. and 3/4" deep, .025" thickness

Consult the Engineering Company for quality parts or sub-assemblies of steel, aluminum, copper, brass, kovar, nickel and monel. Fast, economical service on long or short runs. The most modern machines and micro-precision tools assure highest accuracy.

WRITE TODAY for quotations, sending your sketches or blueprints; no obligation.

THE engineering CO., 27 WRIGHT ST., NEWARK 5, N. J.

BE *Sure* with **CORNISH**
Electronic **WIRES and CABLES**

MICROPHONE CABLES 
 Designed for low capacitance, high insulation resistance, low attenuation—in plastic or rubber insulation to stand severe service

T-V LEAD-IN CABLES 
 Furnished only in pure virgin polyethylene to insure best electrical properties and long life under severe operating conditions

T-V LEAD-IN CABLES 
 Made hollow, of pure virgin polyethylene, for maximum efficiency in receiving Ultra High Frequency signals

INTERCOMMUNICATION CABLES 
 These quality cables are made in various constructions, utilizing plastic insulation for both conductors and jacket

SHIELDED INTERCOMMUNICATION 
 When installation conditions dictate, shielded cables are recommended. Made with internal or external shield—2 and 3 conductors

MADE BY ENGINEERS FOR ENGINEERS

CORNISH WIRE COMPANY, INC.
 50 Church Street New York 7, N. Y.

signed for sound motion pictures." Dr. Olson was selected for the results of his productive career in audio engineering, including his work on the velocity microphone, the duo-cone speaker for high fidelity sound reproduction, and his contributions to the development and improvement of phonograph pickup and recording equipment, underwater sound equipment, and sound motion picture and public address systems.

Dr. Olson, who is today director of the RCA Acoustical and Electromechanical Research Laboratory, Princeton, New Jersey, joined that company in 1928. He holds more than 60 patents on devices and systems in the acoustical field and is also the author of more than 70 articles and papers in professional journals, as well as several books.

Audio Engineers Elect Officers

COLONEL Richard H. Ranger, president of Rangertone of Newark, N. J., has been elected president of the Audio Engineering Society. He succeeds Albert A. Pulley, manager of general recording for RCA Victor records.

A pioneer in the development of transoceanic radio, ship-to-shore telephony, facsimile and electronic organs and chimes, Colonel Ranger has headed his own company since 1930. Rangertone manufactures magnetic tape recorders, primarily



Col. Richard H. Ranger

FOR TRANSISTOR CIRCUIT DESIGNERS!

The New **MA** Automatic Universal TRANSISTOR CURVE TRACER

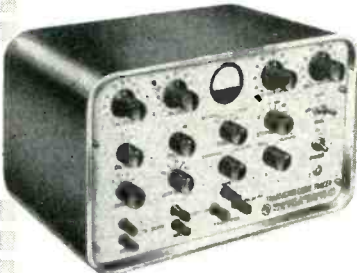

- Displays Output or Transfer Curve in Grounded Base or Grounded Emitter Connection
- Dynamically Displays Entire Family of Curves Simultaneously on Oscilloscope
- Internally Generated Calibration Axes Displayed at All Times in Any One Quadrant

Designed for comparing, matching and selecting—detecting anomalies—studying effects of temperature, age, normal usage and overloading—and for detecting failures and causes. Instrument tests NPN, PNP, Junction and Point Contact Transistors and features flexibility to accommodate new types. Plots entire family of curves simultaneously on a standard laboratory DC oscilloscope.



For illustrated literature containing complete specifications, call or write:

MAGNETIC AMPLIFIERS • INC

AFFILIATE OF GENERAL CERAMICS CORPORATION
 632 TINTON AVE., NEW YORK 55, N. Y.
 Telephone: CYpress 2-6610

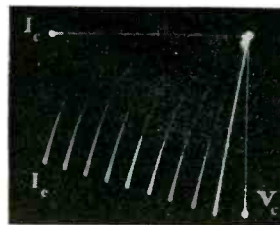

TRANSISTOR CURVES, Output (V_c vs. I_c) : Transfer (V_e vs. I_c)
 VERTICAL CALIBRATOR: 0-1, 10, 100 volts
 HORIZONTAL CALIBRATOR: 0-1, 10, 100 volts
 QUADRANTS: I, II, III, IV
 LOAD RESISTANCE: 100-10,000
 ACCESSORIES FURNISHED: ohms Transistor receptacle

Designers & Manufacturers of Servomechanisms, Magnetic Amplifiers & Industrial Controls

SAVE MONEY!

Measure frequency and FM deviation on a multitude of channels with just two small LAMPKIN METERS



LAMPKIN 105-B MICROMETER FREQUENCY METER—Heterodyne-type, universal coverage, 0.1 to 500 MC. Accuracy 0.005%. Weight 13 lbs. Width 13". Price \$220.00.



LAMPKIN 205-A FM MODULATION METER—Indicates FM voice deviation, ± 25 KC., all channels, 25 to 500 MC.; meets FCC mobile specs. Weight 13 lbs. Width 12 1/4". Price \$240.00.

NEW booklet: "HOW TO MAKE MONEY IN MOBILE-RADIO MAINTENANCE" free on request. Write today!

LAMPKIN LABORATORIES, INC.
Instruments Division
BRADENTON, FLORIDA



Try this on
your recorder!

Model 745
4 1/2" Semi-Flash



WRITE FOR CATALOGUE N1
Shows cases, ranges, prices

Famous names choose Burlington for consistent quality and prompt service. Burlington offers the widest range of VU meters—from 1 1/2" to 4 1/2" in a variety of case materials and styles including bakelite, metal, hermetically sealed and sealed ruggedized. Square, Round, Rectangular and Fan-shaped. Standard meters of every description. "If you don't see it—ask for it"—

BURLINGTON INSTRUMENT COMPANY
127 N. Third St. Burlington, Iowa



CUSTOM BUILT TO SPECIFICATION

BE SAFE WITH

Q-max

A-27

LOW-LOSS LACQUER

- Q-MAX provides a practically loss-free insulating coating for VHF and UHF components of every variety. Q-MAX penetrates deeply to seal out moisture, imparts rigidity to coil windings and promotes stability of electrical circuits. It scarcely alters the "Q" of R-F windings.
- Q-MAX is easy to apply, dries quickly, adheres to practically all materials and has a wide temperature range.

WRITE FOR DETAILED
ENGINEERING LITERATURE

Communication
Products Company, Inc.

MARLBORO
NEW JERSEY

unique in design — rugged in construction

GREEN PANTOGRAPH ENGRAVERS

THE NEW
HEAVY-DUTY MODEL D-2

THE FAMOUS MODEL 106

The three-dimensional bench Model 106 cuts costs — engraves, routs, models and profiles, giving you expert results even by unskilled workers.

The Model D-2 heavy-duty two dimensional Pantograph is a precision machine with a multitude of new features. Open on three sides, it permits complete freedom for engraving, milling, profiling large panels (up to 30" in diameter) or bulky pieces. Single, micrometer adjustment controls vertical depth of cut, automatically adjusting copy table with pantograph. Range of reduction ratios from 2-to-1 to infinity! Vertical range over 10 inches!

For complete information, write to

GREEN INSTRUMENT COMPANY

363A Putnam Ave. Cambridge, Mass.

for motion picture sound and for use on television programs.

He is a fellow of the Society, which elected him executive vice president last year.

Walter O. Stanton, president of Pickering and Co. of Oceanside, N. Y., was elected executive vice-president of the Society. Two vice-presidents were chosen: Ewing D. Nunn, owner of Audiophile Records, Saukville, Wisconsin, who is central vice-president, and Roy A. Long, research engineer of the Stanford Research Institute, Stanford, California, who was chosen western vice-president.

C. J. LeBel, chief engineer, Audio Instrument Co. of New York, a founder and first president of the Society, was reelected secretary for his fifth consecutive term. The treasurer, Ralph A. Schlegel, technical facilities supervisor, WOR-General Teleradio, New York, was also renamed.

Elected as governors were: Victor Brociner, president, Brociner Electronics Corporation, New York; C. Robert Fine, president, Fine Sound, New York, and Donald J. Plunkett, New York studio manager, Capitol Records, New York.

NARTB Selects Engineering Group

THE ENGINEERING advisory committee for the National Association of Radio and Television Broadcasters has been named for the 1955-56 fiscal year.

Raymond F. Guy, National Broadcasting Co., New York, will serve as chairman. Other committee members are:

Glenn G. Boundy, Storer Broadcasting Co., Miami Beach; Ralph N. Harmon, Westinghouse Broadcasting Co., New York; Phillip B. Laeser, WTMJ, WTMJ-TV, Milwaukee; John G. Leitch, WCAU, WCAU-TV, Philadelphia; J. E. Mathiot, WGAL, WGAL-TV, Lancaster, Pa.; James D. Russell, KKTU, Colorado Springs, Colo.

Network representatives on the Engineering Advisory Committee are: Rodney D. Chipp, DuMont-TV, New York; Earl M. Johnson, Mutual Broadcasting System, New



★ ULTRA LOW

capacitance & attenuation

WE ARE SPECIALLY ORGANIZED TO HANDLE DIRECT ORDERS OR ENQUIRIES FROM OVERSEAS
SPOT DELIVERIES FOR U.S.
 BILLED IN DOLLARS—
 SETTLEMENT BY YOUR CHECK
CABLE OR AIRMAIL TODAY

TYPE	μμF/ft	IMPED.Ω	O.D.
C1	7.3	150	.36'
C11	6.3	173	.36'
C2	6.3	171	.44'
C22	5.5	184	.44'
C3	5.4	197	.64'
C33	4.8	220	.64'
C4	4.6	229	1.03'
C44	4.1	252	1.03'



NEW 'MX and SM' SUBMINIATURE CONNECTORS
 Constant 50Ω-63Ω-70Ω impedances

TRANSRADIO LTD. 138A Cromwell Rd. London SW7 ENGLAND

CABLES: TRANSRAD, LONDON

These **PILOT LIGHTS** give you **180° VISIBILITY** for the most effective indication plus **BUILT-IN RESISTORS** (a patented Dialco feature) for operation on 105-125V. or 210-250V.

The required **RESISTOR** is an integral part of the unit — **BUILT IN** (Pat. No. 2,421,321). Also, simple external resistors for all higher voltages.

Every assembly is available complete with lamp.

SAMPLES ON REQUEST AT ONCE — NO CHARGE



FREE Brochure on "Selection and Application of Pilot Lights"

Also write for our latest Catalogues.

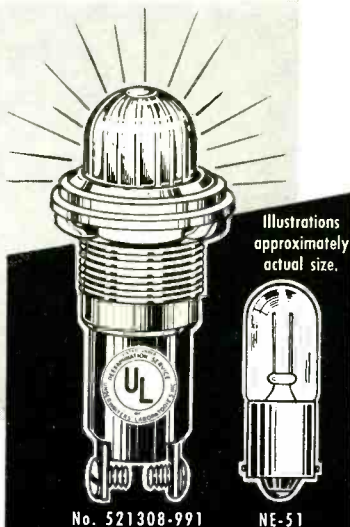

Illustrations approximately actual size.

No. 521308-991

NE-51

For NEON Lamps

Choice of fluted or clear caps; binding screws or soldering terminals.

Available for both 9/16" and 11/16" mounting clearance holes.

Foremost Manufacturer of Pilot Lights

DIALIGHT CORPORATION



PLANT AT BROOKLYN, N. Y.

60 STEWART AVE., BROOKLYN 37, N. Y. • HYACINTH 7-7600

York; William B. Lodge, Columbia Broadcasting System, New York; Frank Marx, American Broadcasting Co., New York.

Honeywell Names Transistor Head



Jerre Manning

JERRE MANNING has been named manager of Minneapolis-Honeywell's transistor division in Minneapolis. Manning was formerly general manager of the company's marine equipment division in Seattle, Wash.

Honeywell specializes in the production and sale of power-type transistors.

Manning will head the division's production, engineering and sales activities. Prior to becoming manager of the marine equipment division in 1954, he was divisional manager at Chicago for Honeywell's Micro Switch division.

Varian Enlarges Palo Alto Plant

VARIAN Associates of Palo Alto, Calif., has started a major enlargement of its Palo Alto plant.

Construction will add 25,000 sq ft of work space and bring the Palo Alto plant area to 63,000 sq ft. The company also occupies about 50,000 sq ft in nearby San Carlos, where klystron tube manufacturing activities are centered.

Additional space will be used for the firm's work in the field of nuclear magnetic resonance, microwave engineering and radar trans-

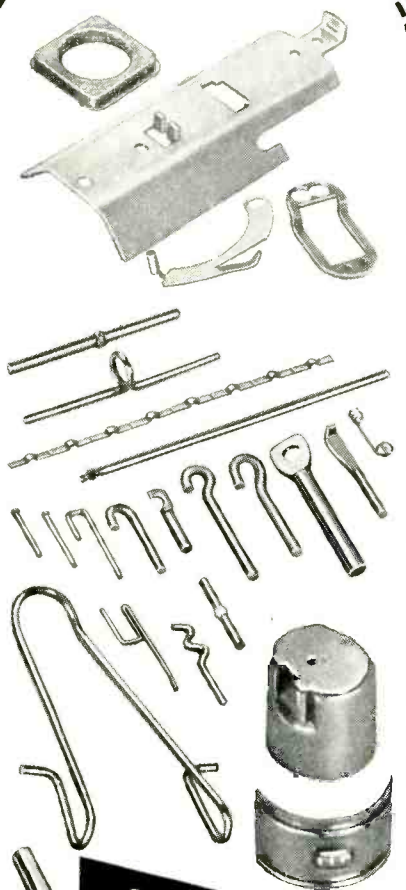

Dependable • Precision Wire Forming and Stamping Specialists

Precision Parts to meet your Production and Engineering needs. From .002" dia. to .125" dia. Radio tube parts—Stampings—Drawings. Modern facilities, high-production equipment.

Send sketch or print for quotation.



MANUFACTURING CO., Inc.
81-A Hudson Street
Newark 3, New Jersey

Want more information? Use post card on last page.
ELECTRONICS — November, 1955

more lives than a cat!

Quality Construction — manufactured with extreme care

Designed—with fresh, new ideas —manufactured with the newest, money-saving production techniques

AEMCO

RELAYS
are standouts for performance
... built to last!

One of today's most versatile relay lines, AEMCO relays are "first choice" for more than 100 of the top names in American industry. Design and construction is tops—for only the finest materials are used in AEMCO relays. Specify AEMCO and you're making your best relay buy. You'll profit by the newest production techniques that speed up delivery and save you money. You'll appreciate the prompt delivery on prototypes, the fast tool up for production. You'll find, too, that an AEMCO relay has more lives than a cat and is built to take it! Actually tested on the job, AEMCO relays are dependable and reliable . . . standouts for performance.

AEMCO relays are available in a wide variety of spring and coil combinations, operating potentials and contact ratings. Types include: Open, can, plug-in base, hermetically sealed, midgets, dual-purpose, delayed make or break, circuit control, current and potential relays. Should one of the hundreds of AEMCO relay types fail to meet your exact requirements, we will be happy to design and build a unit to meet or exceed your specifications.

WRITE TODAY

For more information on the standard AEMCO relay line, write for your free descriptive bulletin today!



AUTOMATIC ELECTRIC MFG. CO.
11 STATE ST. • MANKATO, MINNESOTA

Want more information? Use post card on last page.

advanced
technique

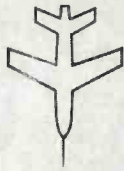

AVIONICS

guided missile
instrumentation

by AVION



Subminiature radar beacons
of extreme ruggedness for

- X-Band
- C-Band
- S-Band

Developed by AVION for
the Signal Corps, these
beacons feature selective
receivers and pulse decoders
to assure interrogation
reliability.

Avion's flexibility and
ingenuity, coupled with
extensive experience in
Electronics, Mechanics
and Optics can better
serve you.

Investigate the career
opportunities in our ex-
panding organization.



AVION

INSTRUMENT CORP.

SUBSIDIARY OF O C F INDUSTRIES, INC.

299 Highway No. 17, Paramus, N.J.

mitters and other electronic sub-
systems, as well as klystrons and
other specialized vacuum tubes.

Working facilities of Varian will
total about 123,000 sq ft on comple-
tion of the new additions, including
about 10,000 sq ft for the subsidiary
firm, Varian Associates of Canada,
which will open in Georgetown, Ont-
ario.

Admiral Builds Research Lab In West

ADMIRAL CORP. is building a new
electronic research laboratory lo-
cated on a 3 acre site in Stanford
Industrial Park. The land has been
leased for 99 years from Leland
Stanford Junior University.

The new laboratory will provide
facilities for the expansion of the
firm's advanced development section
which has been housed for the past
4½ years in Palo Alto. Research and
development engineers, headed by
Robert M. Jones, will staff the labo-
ratory upon its completion late this
year.

The building will house precision
equipment and other scientific appa-
ratus required in research and de-
velopment work on military proj-
ects in the fields of guided missiles,
radar systems, air navigation, nu-
clear radiation measurement, direc-
tion finding and communications, as
well as on the company's civilian
products.

Brush Electronics Promotes Two

DAVID B. PARKINSON and John H.
Harris have been promoted as vice-
presidents of Brush Electronics Co.,
a unit of Clevite Corp. Harris will
be vice-president and general works
manager, and Parkinson will be
vice-president and general engi-
neering manager.

Dr. Parkinson has done develop-
mental work during a 10-year asso-
ciation with the Bell Telephone La-
boratories. He is a recipient of the
Presidential Medal for Merit and
the Potts Medal of the Franklin In-
stitute for outstanding work in the
development of fire-control equip-
ment during the war. He joined
Brush Electronics in 1948, and is

Units normally
covered

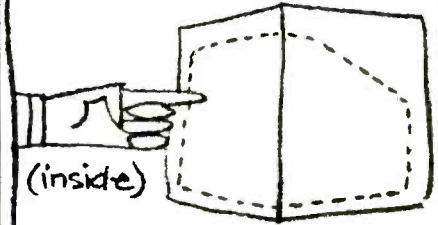

are accessible
fast

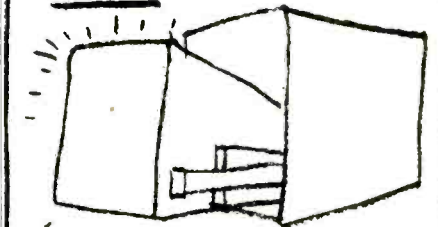

When mounted
on slides



Will an industrial
slide solve your
problem?

If Sliding's
the answer,
see Grant

We have a folder that will
give you an idea of the
scope of Grant Industrial
Slides which we'd like
to send you. Write to
Grant Pulley and Hardware
Corporation, 31-77 White-
stone Parkway, Flushing, N.Y.

MOLYBDENUM

**PURE and THORIATED
TUNGSTEN**

For ELECTRONIC APPLICATION

RIBBONS

STRIPS

FORMED PIECES

Your special metals
rolled to thin sizes
- close tolerances

H. CROSS CO.

15 BEEKMAN ST., N. Y. 38, N. Y.
WOrth 2-2044 and COrtland 7-0470

IDEAS

wanted

Expanding electronic
firm is willing to
purchase outright or
enter royalty agreement
on marketable ideas,
patentable or otherwise.
Openings for engineers
with products and the
ability to create
new ones. Write to

SARGENT-RAYMENT CO.

1401 Middle Harbor Rd.
Oakland, California



24-HOUR CLOCK

DIRECT READING, SYNCHRONOUS, SELF STARTING

Patented precision design. Five mechanically-interlocked metal drum dials. Seconds dial with C. A. A. color quadrants. Indirect illumination. For 115-volt, 60-cycle operation.



Universal Model (illustrated) only 7-7/16" wide x 4-13/16" high x 4 1/2" deep.

Desk Model available for desk, table, or shelf use. Panel Model available for mounting in standard 19-inch rack.

Desk and Panel Models supplied complete with built-in dimmer/off control and push-button synchronizing switch.

Write for Descriptive Literature

Wickes ENGINEERING AND CONSTRUCTION COMPANY

ESTABLISHED 1920

12TH STREET AND FERRY AVENUE

CAMDEN 4, NEW JERSEY

THE BEST TEST FOR TV

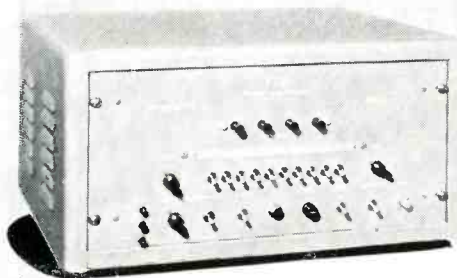

TIC's
TYPE 1105
**VIDEO SWEEP
GENERATOR**

Price: \$600. F.O.B. Carlstadt, N. J.

- High Output
- Flat Frequency Response
- Keyed Carrier Markers to Zero Amplitude
- 75-ohm Internal Impedance
- Sawtooth Sweep Signal

Expressly designed for testing Video equipment requiring a high level signal, the Tel-Instrument Type 1105 provides a 2.0 V. Max. p-p signal from a 75-ohm source into a 75-ohm load, with a sweep range from 50 KC to 10 MC. Features include: Ten selectable crystal controlled pulse-type markers supplied at either integral megacycle point, or as desired; flat output within ± 0.2 db over entire range, attenuated over 60 db; and external markers.

TIC has a complete line of monochrome and color TV studio and production test equipment. Complete information sent at your request.

TIC **Tel-Instrument**
ELECTRONICS CORP.

728 GARDEN STREET • CARLSTADT, NEW JERSEY

PLASTECK TRANSLITE ILLUMINATED PANELS

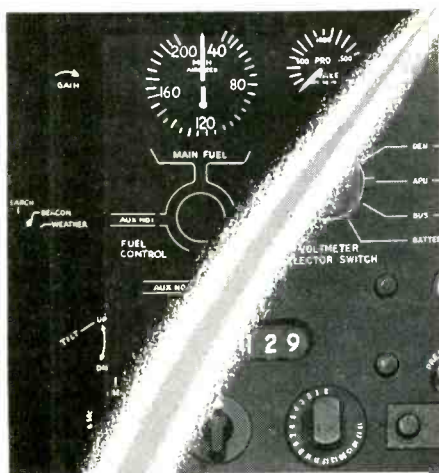

"On Course" NIGHT OR DAY

Pilots in today's super-sonic and commercial aircraft must rely on their instruments to be "on course" night or day. To give them the best possible cockpit control markings at all times, Plasteck edgelighted panels of high contrast permit the pilot to shift his sight from objects in darkness to his instruments without losing his night vision.

In selecting your next edgelighted panel, confer with our plant nearest you for a single source for all control panels, knobs and dials.

We maintain a development laboratory to solve your related problems.

Resist . . .
**COLD • SHOCK • HEAT
VIBRATION
ABRASION**

**3 PLANTS EQUIPPED TO
TAKE CARE OF YOUR PANEL NEEDS**

Plasteck, Inc.

300-4 S. McKenna Poteau, Okla.
TWX: Poteau 492

California Plasteck, Inc.

225 E. Fourth L. A., Calif.
TWX: L. A. 1111

Plasteck Eastern, Inc.

200 E. Washington Hoboken, N. J.

Our engineers and representatives are ready to consult with you at all times. Or write Dept. EL for complete literature on our edgelighted panels, knobs and dials.

"FIRST IN EDGELIGHTING"

Want more information? Use post card on last page.

responsible for all design and production engineering at the company.

Harris joined Brush Electronics in 1944 after holding management and manufacturing positions with Minneapolis - Honeywell Regulator Co. and with Lear. He is responsible for the company's direct manufacturing, production control, maintenance and materials procurement.

Du Mont Labs Elevates Ruiter



JACOB H. RUITER has been promoted to manager of advertising and promotion of the technical products division of DuMont Laboratories. He was previously public relations manager.

He joined the firm in 1943, and has served as an engineer in a number of departments, headed the instruction book section of engineering, and managed technical publications and technical advertising.

He is the author of a number of books and articles dealing with cathode-ray instruments and with television.

United-Carr Acquires Two Companies

UNITED-CARR Fastener Corp. of Cambridge, Mass., has acquired two California companies which will operate as divisions of United-Carr subsidiary companies.

Graphik-Circuits of Pasadena, Cal., has become a division of Cinch Manufacturing Corp., United-Carr's Chicago subsidiary. The division designs and manufactures

let Williams
help you apply

**FERRIC
OXIDES**

to the manufacture
of your

FERRITES

You'll be well repaid by getting the facts on a special group of Pure Ferric Oxides, developed by Williams especially for use in the manufacture of ferrites.

Williams Ferric Oxides analyze better than 99% Fe_2O_3 . They contain a minimum of impurities. They are available in a broad range of particle sizes and shapes. Among them, we're certain you'll find one that's "just right" for your requirements. The proper application of Ferric Oxides to the manufacture of Ferrites is our specialty.

Tell us your requirements . . . we'll gladly send samples for test. Chances are good that our Ferric Oxide "Know How" can save you considerable time and money. Address Dept. 25, C. K. Williams & Co., Easton, Pa.

WILLIAMS
COLORS & PIGMENTS

C. K. WILLIAMS & CO.

Easton, Pa. • East St. Louis, Ill.
Emeryville, Cal.

P.S. We also produce IRN Magnetic Iron powders for the Electronic Core Industry, the Magnetic Tape Recording Industry and others. Write for complete technical information.

Want more information? Use post card on last page.

printed electrical circuit boards.

Plastic Process Company, Los Angeles, Cal., will be operated as a division of Monadnock Mills, a United-Carr subsidiary in San Leandro, Cal. The new division will produce plastic components.

IRC Builds New Plant In California

A NEW electronics plant is being built in California for International Resistance Co.

The plant, which will employ some 300 persons for an annual payroll of \$1million, is for Hycor and Ireal Companies, IRC subsidiaries.

The plant will manufacture resistors, transformers, magnetic amplifiers and other special parts.

The completion date is set for December, 1955.

The land, with improvements and equipment, will represent an investment of more than \$1 million.

The building will contain 26,000 sq ft of floor space.

Bendix Appoints Weapons Director

RUSSELL D. O'Neal has been named director of weapons systems planning of Bendix Aviation Corp. He will head an expanded program of development and production of modern weapons systems.

In 1941, Dr. O'Neal became a staff member of MIT where he engaged in the development of radar. In 1949, he became assistant director of the Willow Run research center of the University of Michigan and, in 1951, was made director of the center in charge of electronic and guided missile work.

In 1953, he became assistant division manager of Consolidated Vultee Aircraft Corp.

Baird Names Transistor Head

WALTER G. DRISCOLL has been appointed assistant director of research at Baird Associates in Cambridge, Mass., manufacturers of precision instruments. He will be in charge of the company's transistor-



Arrows point to Paliney #7 contacts used in this Fairchild Type 746 Precision Potentiometer.

NEY'S small parts play a BIG part in precision instruments

Reliability of many precision electrical instruments depends upon accurate transmission of electrical signals between moving parts. The Potentiometer Division of the Fairchild Camera and Instrument Corporation has selected Ney Paliney #7* for use as wipers and sliders in their precision potentiometers because

Paliney #7 provides the important advantages of a long life with excellent linearity and the ability to hold noise at a minimum.

Ney manufactures many other precious metal alloys which, like Paliney #7, have ideal electrical characteristics, high resistance to tarnish, and are unaffected by most industrial atmospheres. Ney Precious Metal Alloys have been fabricated into slip rings, wipers, brushes, commutator segments, contacts, and intricate component parts and are used in high precision instruments throughout industry. Should you have a contact problem, a call to the Ney Engineering Department will result in study and recommendations which will improve the output of your electrical or electronic instruments.

THE J. M. NEY COMPANY • 179 ELM ST., HARTFORD 1, CONN.
Specialists in Precious Metal Metallurgy Since 1812

*Registered Trade Mark

9NY55B

SHOCK PROOF

VACUUM TUBE RETAINERS

These retainers are used to secure Vacuum Tubes and to resist side motion of Vacuum Tubes used in radio equipment which is subject to shock and vibrations. These retainers meet the requirement of all JAN specifications. The insulated portion is made of a melamine base Fibre Glass Phenol which provides 300 volts insulation to ground and withstands a temperature of 350 F. The insulated plate can readily be fastened or released by hand.

Available for envelope types T7, T8, MT8, T9, T12, ST12, T12ZDI, ST14, S14, ST16, T5½, T6½, MT-IC, ST19, T14, ST128CT-9.

Manufacturers of Electronic Components

JAMES IPPOLITO & CO., INC.
1624 Stillwell Ave., Bronx 61, N. Y.

Now STYRACON "B" CAPACITORS

In Wide Range
Of Needed Values
For Critical Applications

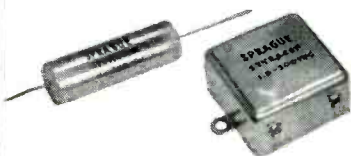

Now you can select Sprague Styracon "B" capacitors in the most needed voltage, capacitance, and tolerance values for those critical applications in analog and digital computers, precision timing circuits, etc.

Employing a specially processed polystyrene plastic film as the dielectric, these capacitors have extremely high insulation resistance, freedom from dielectric absorption, extremely low power factor (or high Q), close capacitance tolerance, and unusually excellent capacitance stability. Temperature coefficient of capacitance over the rated operating temperature range of -55°C to $+85^{\circ}\text{C}$ is -100 ppm/ $^{\circ}\text{C}$ and practically linear, and is independent of frequency.

Sprague Styracon "B" capacitors are also available in various mechanical configurations to meet application needs. All are hermetically sealed in metal cases.

Write for Engineering Bulletin 250A, available on letterhead request to the Technical Literature Section, Sprague Electric Company, 35 Marshall Street, North Adams, Mass.

uF	VDC	CATALOG NO.		CASE STYLE
		$\pm 5\%$ TOL.	$\pm 2\%$ TOL.	
.01	200	114P10352S2	—	TUBULAR
.01	600	114P10356S2	—	
0.1	200	114P10452S2	114P10422S2	TUBULAR
0.1	600	114P10456S2	114P10326S2	
0.5	200	111P1J	111P1G	BATH-TUB
0.5	600	111P3J	111P3G	
1.0	200	111P2J	111P2G	
1.0	600	111P4J	111P4G	

World's Largest Capacitor Manufacturer

SPRAGUE®

ized electronics department.

A one-time special agent of the Federal Bureau of Investigation, Dr. Driscoll joined the Baird staff from the Department of Defense.

Norden-Ketay Appoints Roehm



PERRY R. ROEHM has been appointed executive vice-president of Norden-Ketay Corp. He was, prior to this appointment, vice-president of the company in charge of engineering and sales.

He served as chief production engineer of Norden's New York City plants, and later became production superintendent at the U. S. Navy bombsight plant in Elmira, New York, which was operated by Norden.

In 1944, Roehm joined the Bardeen Corp., where he was a vice-president and director. He joined Norden-Ketay in March, 1955, following the integration of Norden Laboratories and Ketay Instrument.

Borg-Warner Builds For Research

CONSTRUCTION in Des Plaines, Ill., of a multi-million-dollar Borg-Warner research center is planned by the company.

Construction of the first unit of the research center has been started.

The new laboratory will contain

FOR HIGH FREQUENCY HIGH VOLTAGE

SPACE SAVING APPLICATIONS

GARDE

Miniature & Sub-Miniature
INSULATED STAND-OFFS,
FEED THROUGHs & SPACERS

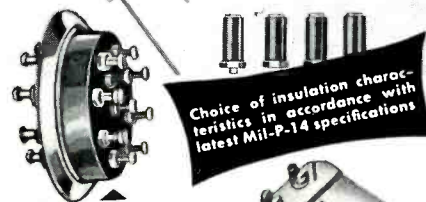
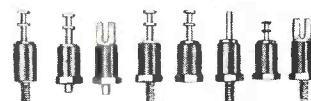
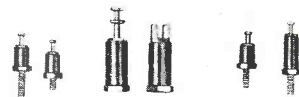

Choice of insulation characteristics in accordance with latest Mil-P-14 specifications

HERMETICALLY SEALED HEADERS

COIL FORMS

MULTIPLE TERMINAL CONNECTOR HEADS

BARRIER STRIPS

Molded as a unit with Bus Bars require no insulating backing.

For users to properly assess the outstanding features and advantages of Garde Components, samples will be sent on request. A detailed technical catalog is now available. Be sure your name is on our mailing list.

We have complete facilities to accommodate your special requirements, ranging from Engineering Consulting Service to Precision Design and Production.

GARDE MANUFACTURING COMPANY

MOLDERS OF THERMOPLASTIC AND THERMOSETTING MATERIALS
588 Eddy Street, Providence 3, Rhode Island
Sales Representatives in Principal Cities

Want more information? Use post card on last page.

November, 1955 — ELECTRONICS

Want more information? Use post card on last page.

Complete Reliability

from -70° to $+150^{\circ}$ C.



with the New, Improved 'PANCLIMATIC' Coating

This new protective coating permits the use of these resistors under the greatest extremes of temperature. In addition, it affords better moisture protection for greater stability. It resists abrasion and impact with no tackiness, and it is chemically inert to common solvents and plasticizers. Storage stability is better than 1%. Operating at 50% nominal rating, and at an ambient temperature of 100° C. the stability of these 'Panclimatic' Coated resistors is better than 1%.

The same high standards of design, construction, and performance which have established Welwyn as a leading name in the field of precision resistors, will also identify these newly developed products.



For complete data and specifications write to Dept. GL-7
Welwyn International, Inc.

3355 Edgecliff Terrace, Cleveland 11, Ohio

SEALING
DIPPING
POTTING
IMPREGNATING



INSULATING
FUNGUSPROOFING
MOISTUREPROOFING
HEAT CONDUCTING

WAXES BIWAX COMPOUNDS

Developed and produced for manufacturers of electronic components and other electrical units.

Specifications and samples available on request.

Information relative to your problem or application will enable us to make suggestions and recommendations.

BIWAX CORPORATION

3445 HOWARD STREET
SKOKIE, ILLINOIS

M-DC-3A super-regulated
voltage standard



M-DC-2A super-regulated voltage
and current standard

Calibration Partners

The two units combined, provide voltages up to 509.99 volts dc in 0.01 volt steps, however, either unit can function independently. The M-DC-2A provides current outputs of from 0 to 109.99 ma dc in 0.01 ma steps and voltages from 0 to 109.99 volts dc in 0.01 volts steps. Overall accuracy of both units is within 0.05 pct. of selected voltage or current.



RADIATION Inc.

Electronics • Avionics • Instrumentation

Melbourne, Fla.
Orlando, Fla.

if you want

BORON-FREE

FUSED

QUARTZ

LABORATORY

WARE

you can get it!

Let the world's largest producer of fused quartz products help you with your most exacting technical requirements.

Recent laboratory analysis indicates our BORON-FREE fused quartz products contain only one part of BORON in 25,000,000 parts of quartz. Spectrographically, other impurities are practically negligible.

TRANSPARENT VITREOSIL SPECIAL APPARATUS

For ultra-violet applications, metallurgical investigations, chemical research and analysis, photochemistry, spectroscopy and physical, optical and electrical research.

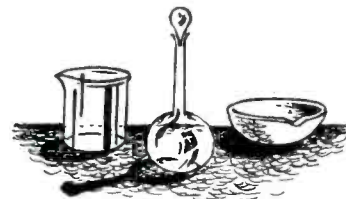

Catalogs and technical data of our complete line available. Write today. Please use coupon below.



**THERMAL AMERICAN
FUSED QUARTZ CO., INC.**
18-20 Salem Street, Dover, New Jersey
Please send technical data on

Company _____
Name & Title _____
Street _____
City _____ Zone _____ State _____

MARKEM[®] MACHINES

Solve "IN-PLANT" PRINTING PROBLEMS

- FASTER - NEATER - AT LOWER COST

Markem machines meet many marking requirements: on flat, curved or irregular shaped objects of plastics, paper, glass and metal. Mark items at production rates — or a few at a time — only as you need them. Easily changed type for variable data produces neat, clear imprints in fast drying inks. Machine operation is simple.

Markem can supply the right machine, type and ink for your needs. Write for information, enclosing item you want to mark.

PRODUCTS · PACKAGES
PARTS · LABELS



MARKEM MACHINE CO.
KEENE 5, NEW HAMPSHIRE

TRANSFORMERS FOR AVIATION APPLICATIONS



Our facilities for manufacturing miniature type transformers embraces many different types. Our methods of processing and testing are positive assurance of uniformly high performance standards and long life as required by military specifications. We invite your inquiries.

ACME ELECTRIC CORPORATION
3111 WATER STREET • CUBA, N. Y.
West Coast Engineering Laboratories:
1375 W. Jefferson Blvd. • Los Angeles, Calif.
In Canada: Acme Electric Corp. Ltd.
50 Northline Road • Toronto, Ontario



PLANTS AND PEOPLE

(continued)

facilities for metallurgical, electronic, electrical, chemical, acoustical, hydraulic, applied mechanical, physics and nuclear research. The laboratory also will house a complete machine and model shop, a modern computation center and a large technical reference library. About 100 scientists and engineers will be engaged at the start of the operation. Building of the initial unit is expected to be completed next spring.

Sperry Products Acquires Western Inspection

WESTERN Inspection of Midland, Texas has been acquired by Sperry Products of Danbury, Conn. Western Inspection will become Sperry Western. James H. Binford continues as president, with Sperry's R. B. Manning named vice-president and treasurer and D. W. Gordon secretary and assistant treasurer.

Western provides a service for the non-destructive testing of tubular goods in the oil industry.

Raytheon Sets Up Lab, Names Nichols, Spencer

RAYTHEON Manufacturing Co. has established a laboratory at the White Sands Proving Grounds in Las Cruces, N. M. The laboratory will conduct tests and evaluation of equipment which the firm, as prime contractor, is developing for Army Ordnance.

A large building on the base has been allocated to the company, and the tools and equipment necessary to equip the facility are being furnished by the firm and the U. S.

The lab's functions are being integrated with the firm's guided missile test facilities at Point Mugu, Calif. Robert Skidmore has been transferred from Pt. Mugu to coordinate the work at the White Sands laboratory.

Nathaniel B. Nichols has been named manager of Raytheon's commercial equipment engineering activities. He was formerly manager of the firm's research division.

During World War II, he was associated with MIT where he head-

Couch Rugged

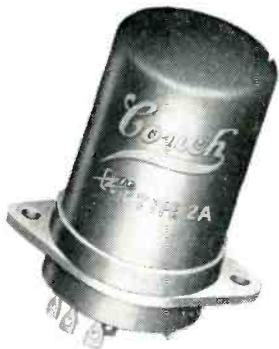

RELAYS

Specify the COUCH MODEL 2A or 4A relay whenever HIGH SHOCK-HIGH VIBRATION capabilities are required and for DRY-CIRCUIT applications.

VIBRATION . . . 5 to 25 cps @ 0.4" peak to peak excursion; 25 to 2000 cps @ 20G acceleration; No contact opening, relay energized or de-energized.

SHOCK ELECTRICAL . . . 75G for 10 milliseconds minimum. No contact opening, relay energized or de-energized.

SHOCK MECHANICAL . . . 200G minimum . . . no physical damage to relay or change in electrical characteristics.

Models 2A and 4A are subminiature, hermetically sealed, D.C. relays which meet and in several respects exceed the requirements of MIL-R-5757B. They are actuated by a "balanced-armature" rotary motor. Both models are particularly suited to dry-circuit switching applications.

LEADING PARTICULARS

Ambient Temp.:	-65°C to +125°C
Weight:	3.2 oz. maximum
Height of Case:	1½" maximum
Diameter of Case:	1⅜" maximum
Terminals:	Flattened & pierced
Contact Arrangement:	DPDT — Model 2A 4PDT — Model 4A
Contact Material:	Fine silver to molybdenum
Operation:	Simultaneous operation, simultaneous release, no contact bounce
Pull-in-power (Coil):	¾ watt — Model 2A ½ watt — Model 4A

Test Data and Literature on Request
Built-in Dependability



NORTH QUINCY 71, MASSACHUSETTS

Want more information? Use post card on last page.

ELECTRONICS — November, 1955

PLANTS AND PEOPLE

(continued)

ed the servo group of the fire control division. Subsequently, he became research director of the Taylor Instrument Companies, leaving in 1950 to accept a professorship in electrical engineering at the University of Minnesota.

Percy L. Spencer, vice-president of Raytheon and general manager of its microwave and power tube operations, has been elected a director of the firm.

He joined the firm in 1925 and his technical contributions include the strapping and tuning of magnetrons, applications of microwaves to industrial and medical fields, innovations in the photocell and gas rectifier arts and new techniques of manufacturing. He came to the company from Submarine Signal Co. of Boston.

Cook Forms New Electronics Firm



Frank R. Cook

THE FRANK R. COOK Co., a new research and manufacturing organization, has been formed by a group of Denver and New York industrialists in Colorado. The company will engage in the development of equipment for aeronautical and electronic industries. It will be



536K Multimeter Kit \$12.90
Wired \$14.90
1000 ohms/volt

425K 5" Scope
Kit \$44.95
Wired \$79.95

470K 7" Push-Pull Scope
KIT \$79.95. WIRED \$129.50.

YOU BUILD

EICO

**KITS
IN ONE
EVENING-**

**but they
last a lifetime...
and you
save 50%**

**38 Kits and 42 Instruments —
the Industry's most complete
line of MATCHED
TEST INSTRUMENTS**

½ - million EICO Instruments are now in use the world over! That's the proof of EICO's leadership in Value.

For latest precision engineering, finest components, smart professional appearance, lifetime performance and rock-bottom economy — see and compare the EICO line at your Jobber before you buy any higher-priced equipment! You'll agree with over 100,000 others that only EICO Kits and Instruments give you the industry's greatest values at lowest cost



377K
Sine & Square Wave Audio Gen.
Kit \$31.95. Wired \$49.95

360K Sweep Gen.
Kit \$34.95. Wired \$49.95

1050K Battery Elim.
Kit \$29.95. Wired \$38.95

625K Tube Tester
Kit \$34.95
Wired \$49.95

Write NOW for FREE latest Catalog E11



ELECTRONIC INSTRUMENT CO., Inc.
84 Withers Street, Brooklyn 1, N.Y.

Want more information? Use post card on last page.

SENSITIVE RELAYS that R-E-S-I-S-T



SHOCK



VIBRATION



TEMPERATURE

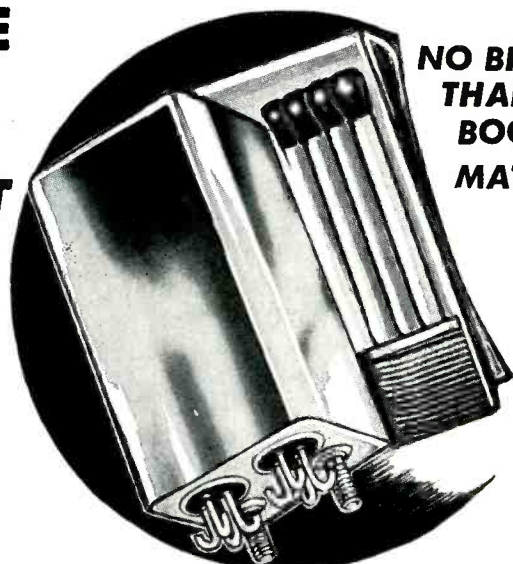

NO BIGGER THAN A BOOK OF MATCHES

Here are miniature sensitive relays—single or double-pole types—which fulfill the most rigid requirements of space, shock, temperature and vibration in both commercial and military applications. The Series 100—105—106 relays are hermetically sealed and have a long life expectancy. Write for Bulletin SR— 6

Engineering representatives in principal cities.



MODEL 202D WIDE-BAND CHAIN AMPLIFIER

EXTENDED LOW FREQUENCY RESPONSE
1 kc - 210 mc

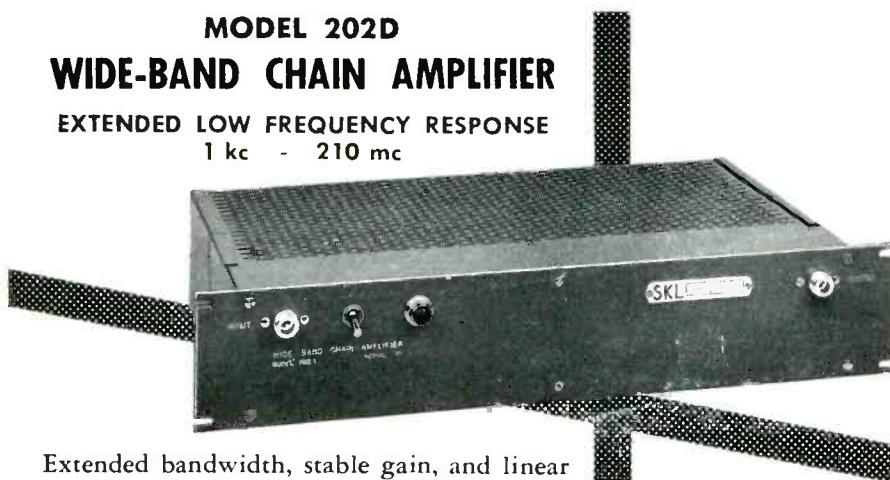

Extended bandwidth, stable gain, and linear phase shift make the new SKL Model 202D Wide-Band Chain Amplifier ideal for the accurate amplification of pulses and transients. The flat frequency response curve of the Model 202D Wide-Band Chain Amplifier permits cascading of a number of stages. Thus, low-level broad band voltages such as pulses, transients, and television signals can be amplified to useful levels. The Model 202D Wide-Band Chain Amplifier finds application in oscillography, radar, nuclear and television research.

For further information write for Bulletin 202P-4

SPECIFICATIONS

- RISE TIME
0.0026 μ sec
- VOLTAGE GAIN
20 db
- BANDWIDTH
1 kc - 210 mc
- IMPEDANCE
200 ohms
- REGULATED POWER SUPPLY

SKL SPENCER-KENNEDY LABORATORIES, INC.
1320 SOLDIERS FIELD ROAD, BOSTON 35, MASS.

headed by Frank R. Cook.

The company has completed negotiations for the purchase of laboratory and manufacturing facilities in Denver and in Colorado Springs.

Prior to forming the new organization, Cook served for five years as director, aeronautical engineering, and director of research and planning of the Minneapolis-Honeywell Regulator Co. in Minneapolis, Minn.

Gabriel Selects Electronics Head

STEVEN GALAGAN has been appointed director of engineering for Gabriel Laboratories and the Gabriel Electronics Division in Needham Heights, Mass.

In 1946 he was appointed section head of the antenna division at the U. S. Navy underwater sound laboratory in New London, Conn. He was also an instructor at Mitchell College, New London in mathematics and physics.

In 1952 he was associated with the General Electronics Laboratories of Cambridge, Mass., as chief engineer. Here he devoted his time to research and development in the fields of telemetering, countermeasures, computers, and special electronic instrumentation and circuitry. He was elected to the board of directors of General Electronics in 1953.

Galagan came to Gabriel in early 1955. Prior to his appointment as director, he held the position of general sales manager.

Los Angeles Sets Up AEC Committee

THE ELECTRONICS Committee of the Los Angeles Chamber of Commerce has inaugurated a new information service to aid local firms in dealing with the Atomic Energy Commission.

The new service will provide data on procedures for submitting research proposals directly to AEC divisions of research, biological, medical, and reactor development in Washington, as well as for subcontract work for major research institutions.

In addition, the service will sup-

• Electronic Motion Pictures

A History of the Television Camera

By Albert Abramson

The past and present uses, and possible future development of the electronic camera. Deals with precursors of the electric motion picture; the use of film camera and sound recording in early television; experimental processes of television recording, both visual and nonvisual; development of commercial and large-screen television; and progress to date in England and America. Illus. \$5.00

UNIVERSITY OF CALIFORNIA PRESS

Address: Berkeley 4, California

HERE'S KLIPZON
The *Smallest* CLIP CONNECTOR made!

LOOK - HOW EASY TO USE!

ACTUAL SIZE

TYPE B
25c ea.

WHY USE OLD STYLE CLIPS WHEN MODERN SELF HOLDING KLIPZONS ARE AVAILABLE

MINIATURIZED FOR MODERN ELECTRONICS

For QUICK, EASY-TO-MAKE TEMPORARY CONNECTIONS

PLUS . . . these EXTRA Features:

- ★ FITS INTO PIN JACKS, TUBE SOCKETS, BINDING POSTS AND SMALLEST SPACES IN CIRCUITRY.
- ★ FITS ONTO WIRES UP TO = 12 B&S Ga.
- ★ STAINLESS STEEL NEEDLE POINT TO PIERCE INSULATION.
- ★ REMOVABLE INSULATING SLEEVE ON SHANK PREVENTS ACCIDENTAL SHORTS.
- ★ SOLDERLESS CONNECTION FOR LEAD WIRE IN RED OR BLACK TENITE HANDLE.

At your LOCAL DISTRIBUTOR — or write on your letterhead for FREE SAMPLE

UNITED TECHNICAL LABORATORIES
BOX 425 F • MORRISTOWN, N. J.

Transformers for special applications

Need a transformer for a special or unusual application? Check the qualifications of Caledonia Electronics.

1. **DESIGN EXPERIENCE.** Large staff of design engineers with extensive experience in circuit design — audio, radar, RF, UHF. Engineers who can understand your circuit needs and know how to meet them.
2. **MANAGEMENT EXPERIENCE.** Caledonia's management represents more than 250 years cumulative experience in the electronics industry . . . almost all associated with the manufacture of communications transformers.
3. **PRODUCTION EXPERIENCE.** Production and inspection staffs thoroughly trained in every phase of transformer manufacture and quality control.

This experience has solved successfully hundreds of problems in transformer design. For further information and help with your problems, write to

CALEDONIA

ELECTRONICS AND TRANSFORMER CORPORATION

Dept. E-11, Caledonia, N. Y.

NUCLEAR ENERGY, MY EYE... IT'S POWERED BY BURGESS BATTERIES!

Burgess engineers have devoted more than forty years to special battery development and manufacture. Now—you can profit by it. The complete Burgess factory . . . engineering . . . design . . . production . . . is available to provide you with the exact dry battery for your particular application.

Hundreds of battery types are already available.

Contact your distributor for complete information or advice, or write to Burgess Battery Company.

BURGESS BATTERIES
BURGESS BATTERY COMPANY
FREEPORT, ILLINOIS

CODE MARK Anything! WITH

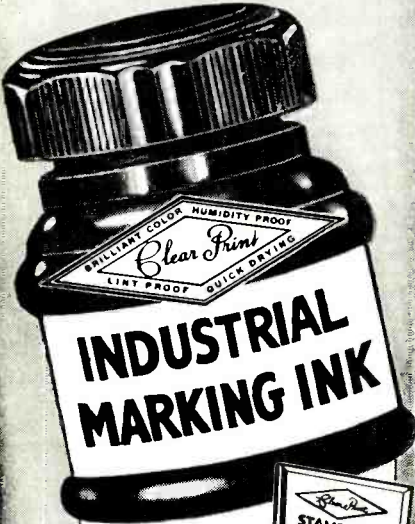

★ **CODE MARKING INKS**

For Resistors and Capacitors. For Machine or Hand Application.

Whatever the substance, Phillips has an ink to mark it permanently and legibly—or can make one. Marking experts insist on "Clear Print" Wood Block Stamp Pads and Opaque Inks. They get clear, sharp, fast-drying impressions. Also inks for brush, pen, stencil or machine application available in a variety of colors and quantity containers.

★ **Quick Laboratory Service** On Your Problem Markings.

★ **To Permanently Mark . . .** Metals, Plastics, Glass, Wood, Paper, Leather, Ceramics—glazed, varnished or lacquered surfaces and virtually every other known material.

CANC
INSP
RECO
42
35
721
PART NO
10
BU

WRITE FOR FREE BROCKET

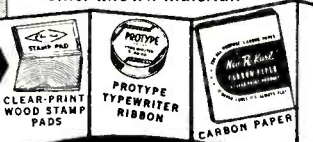

L. A. PHILLIPS, President
PHILLIPS PROCESS CO. INC.
192 MILL STREET
ROCHESTER 14, N. Y.

ply information on procedures for selling equipment to independent contractors handling equipment procurement for the AEC. According to the C of C, the AEC used 5 to 15 percent of the \$5.5 billion spent in 1954 on plants and equipment for the purchase of electronics supplies.

Beckman Purchases Ceramics Firm

BECKMAN Instruments of Fullerton, Calif. has purchased Place Industrial Ceramics Corp. of El Segundo, Calif., developers of a film-type resistance element, applicable to a number of the firm's instrument products.

The plant will be under the management of the company's Helipot division of Pasadena. First project for the ceramics firm will be the manufacture of trim-type potentiometers.

Thomas Place Sr. and Thomas Place Jr. will continue to supervise plant operations.

Norden-Ketay Buys Frohman Manufacturing

NORDEN-KETAY Corp. purchased all the outstanding stock of The Frohman Manufacturing Co. of Miami, Florida in exchange for approximately 50,000 of its shares.

The purchase includes the total goods and assets of Frohman, its Miami plant and its turbine products division at Boca Raton, Fla.

Frohman is engaged in manufacturing precision and high speed shafts, gears and gear trains. The firm is expected to gross over \$1.5 million a year. Its present backlog is \$1.5 million.

I. D. E. A., Acquires Radio Apparatus Corporation

RADIO APPARATUS Corp. of Indianapolis, Indiana, has been acquired by I. D. E. A. through an exchange of common stock.

Radio Apparatus will continue to operate under the name Monitoradio Division of I.D.E.A. The firm produces vhf receivers for moni-

can you qualify

in

- physics
- chemistry
- mathematics
- engineering
- metallurgy
- electronics
- nucleonics
- aerodynamics

Los Alamos Scientific Laboratory, with some of the Western World's finest facilities and equipment, is seeking top level scientists and engineers desiring to further their careers in independent and original research, application and development work.

Excellent opportunities now exist at Los Alamos for qualified men wishing to further their scientific careers.

The nation's most important institution for the development of atomic weapons, offers unlimited opportunity for individual growth and development. In addition to its continuing and ever expanding achievement in nuclear weapons research, the Laboratory is now pioneering in the fascinating fields of nuclear power and nuclear propulsion.

The community itself, nestling among pines on the lower eastern slope of the towering Jemez mountains, is delightful—an ideal small city in which to live and raise a family.

Direct your inquiry and background resume to
DEPARTMENT OF
SCIENTIFIC PERSONNEL
Division 203



Want more information? Use post card on last page.

toring emergency communication broadcasts. No change in personnel or policy is anticipated as a result of the merger.

Admiral Born Joins Collins Radio

REAR ADMIRAL Arthur S. Born, USN (Ret.), has joined Collins Radio Co. of Cedar Rapids, Iowa, as assistant to the vice-president of research & development.

He has served in various capacities in the Navy, including command of the USS Badoeng Straits and head of the electronics division of the Bureau of Aeronautics. His latest assignment has been in the Office of the assistant secretary of defense, applications engineering.

EICO Appoints Vice-President

PHILIP A. PORTNOY has been appointed a vice-president of EICO, Electronic Instrument Co., kit and instrument manufacturers.

He has been with EICO since 1951 as executive assistant to H. R. Ashley, president. Prior to that, he was a practicing attorney and during World War II, taught radar and radio electronics and repair for the Signal Corps.

Burrough Selects Control Manager

CARL BECKMAN has been appointed manager of the newly organized automation and process control division of the Burroughs Corp. re-



Carl Beckman

WHAT CLAMP TO USE WHERE TOLERANCES ARE LARGE

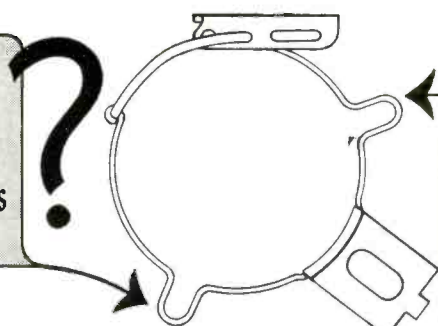

AUGAT'S NEW TWO TENSION LOOP CLAMPS

Augat two-tension loop clamps are the long-sought answer for uses where tube base tolerances vary up to .040. The bands of these sturdy clamps are made of Beryllium copper, heat treated to retain original tension and nickel plated to withstand a 96 hour salt spray test with no adverse effect.

The remaining parts of Augat's two-tension loop clamps are made of 18% nickel silver.

Write today for catalog and samples.

AUGAT BROS. INC.

31 PERRY AVENUE • ATTLEBORO, MASS.

A COMPLETE SPINNING SERVICE

FOR THE

ELECTRONIC INDUSTRY

Metal Spinning

FROM 10' PARABOLA TO THIMBLE-SIZE CASE

Metal Fabrication

COMBINES SPINNING WITH FABRICATION, WELDING and ANNEALING TO PRODUCE A FINISHED PART. (Gov't. certified welders)

Mu Metal Shields

ANNEALED IN OUR OWN HYDROGEN ATMOSPHERE OVEN





COMMITMENTS SOLICITED. SEND FOR OUR BROCHURE
WE ARE A JOB SHOP — WE HAVE NO PRODUCT OF OUR OWN

TEINER

engineering corporation

115-E Madison Street, Malden 48, Mass.

AMERICAN TELEVISION &
RADIO CO. ST. PAUL, MINN.

introduces the
new

ATR TV

*Full Door Console
Receiving Sets*

UNSURPASSED
IN BEAUTY

UNEQUALLED
IN PERFORMANCE

UNMATCHED IN
QUALITY
CONSTRUCTION

exclusive
profitable
dealer
franchises
now available



*designed
with the
Serviceman
in mind
... easy to
get at*

WRITE TODAY FOR COLORFUL
BROCHURE SHOWING THE
NEW LINE OF ATR TV SETS

ALSO MANUFACTURERS OF DC-AC INVERTERS,
"A" BATTERY ELIMINATORS, AUTO RADIO VIBRATORS

ATR AMERICAN TELEVISION & RADIO CO.
Quality Products Since 1931
SAINT PAUL 1, MINNESOTA-U.S.A.

Want more information? Use post card on last page.

PLANTS AND PEOPLE

(continued)

search center in Paoli, Pa. He will direct the design and development of industrial automation equipment using digital computer techniques. Beckman formerly was manager of the center's electromechanisms department, development division.

Motorola Establishes New Department



Robert F. Schulz

MOTOROLA has consolidated its microwave and power utility products department. Robert F. Schulz has been made manager of the new department which will be called the microwave and industrial products department. Commercial sales activities will be directed by Leonard G. Walker and James Stewart will be in charge of export and special accounts sales.

Since joining Motorola in 1953, Schulz has directed the engineering, production and sale of the Motorola line of microwave equipment. His 25 years of previous experience in the electronic industry include 13 years in various positions in the broadcast industry, three years as a consulting radio engineer and nine years as supervising engineer and deputy director for Airborne Instrument Laboratory.

Photon Inventors To Be Honored

RENE A. HIGONNET and Louis M. Moyroud, of Cambridge, Mass. will be awarded John Price Wetherill Medals of The Franklin Institute of the State of Pennsylvania, "for

1,000,000 Printed Circuits

in operation
and not ONE failure
due to
Flux Corrosiveness

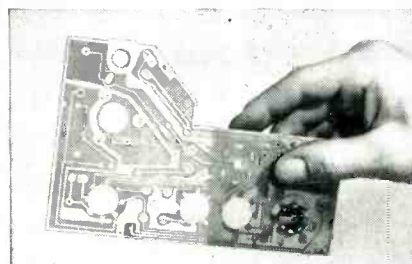

with
LONCO

INSULATING ROSIN FLUXES and FLUXCOTE 21XR

Whatever your printed circuit production, Dip... Spot... or Area soldering you can get this same performance with Lonco Soldering Fluxes!

plus

- smooth, fast action
- good finished appearance
- high leakage resistance
- maximum heat absorbing and anti-sputtering characteristics

All Lonco Fluxes protect your circuits before soldering, during alloying and in their residues.



← REQUEST FREE
TECHNICAL BULLETIN
"The Soldering of
Printed Circuits"

Also request free samples and data on other Lonco Products used in printed circuit manufacture: FLUX REMOVERS

OXIDE REMOVERS • FLUX THINNERS • SEALBRITE COATINGS
FERRIC CHLORIDE • INSULATION COATINGS



**LONDON CHEMICAL
COMPANY, Inc.**

1535 North 31st Avenue
Melrose Park, Illinois

Want more information? Use post card on last page.

November, 1955 — ELECTRONICS

America has homework to do!



THERE'S PROBABLY a lot about your town that makes you want to brag a bit about it.

But there's one thing you *can't* be proud of. And it's a shame you share with just about every other community in America.

The homes where far too many people live are a disgrace. Slums, semi-slums, housing blight are with you. Fixing them up is the homework to be done.

If your town is like most in the U. S., here's what the figures show: 1 out of every 10 homes are rock-bottom slums. Nearly one-half urgently need basic repairs.

But slums are something that is happening on the other side of town, you may say. The problem isn't mine.

Slums are YOUR homework

Distance is no barrier against the threat and cost of housing blight.

Your taxes go up because it takes more money for your town to fight the diseases and delinquency and poverty spawned in the slums. The security of your family goes down because the slum is the natural parent of crime.

Where your business comes in

Every firm has a responsibility toward the town where it's located. Part of it is to support community improvements as any other good citizen would.

Some slums are beyond repair. They must be torn

down and a fresh start made. Others can be made to conform to accepted living standards. So it is up to you to get behind every sound program which seeks to provide adequate housing for all our people.

Civic and individual groups must have business backing . . . *your* firm's backing if they are to succeed.

Follow the course of Action!

A group of Americans from every walk of life has joined together in a non-profit organization to combat home and community deterioration, A.C.T.I.O.N., the American Council To Improve Our Neighborhoods.

Send today for a free copy of "ACTION." It explains what A.C.T.I.O.N. is and proposes to do. It lists booklets, research, check-lists, and other material which can help you. Address P. O. Box 500, Radio City Station, New York 20, N. Y.

ACTION

American Council To Improve Our Neighborhoods



ALLEN
MINICAP
AND
MINISET
SOCKET SCREWS!

#0 THRU #3

*Dependable fastening,
easier assembly, for your
"miniaturized" products*

Count on these Allen Miniature Cap and Set Screws for Allen accuracy and uniformity — in sockets, threads, heads and sizes. Extremely close tolerances are maintained in these very small screws. Strength is so great that you can use fewer, or smaller, screws to hold securely.

Sockets are highly accurate, for maximum tightening — so accurate that these miniature screws will hold to the key for placing and starting. Allen Minicaps are knurled, and *trimmed* on top and under the heads, for better fit and appearance.

Allen's long experience in dependable fastening is at your service when you're developing your "miniaturized" designs. Just call on the Allen engineers for prompt and practical help.

Your Industrial Distributor has Allen Minicaps and Minisets now.

*Sold Only Through Leading
Industrial Distributors.*



Want more information? Use post card on last page.

their conception and development of the Photon type-composing machine."

The Photon, a photographic type composing machine, utilizes photographic processes along with applied communication network theory, numerical counting processes and control mechanisms to produce a wide variety of type styles and sizes into justified lines of characters on photographic film.

Much of the early work on photo-composition was conducted in Paris under the difficulties and shortages of the German occupation. The Lithomat Corp. and a group of scientists were interested, and the Graphic Arts Research Foundation of Cambridge, Mass., was founded to perfect the device and provide a research facility capable of undertaking fundamental problems in the field of graphic arts. The organization, financed by the printing and publishing industry, developed the machine and licensed Photon of Cambridge, Mass., to commercialize the finished machines.

Ten of these machines have been built in the United States. Five are at the Photon plant in Cambridge and five on contract with publishing and printing houses. Several published books have been set on the Photon. The first was *The Wonderful World of Insects* released in 1953. Also, in November 1954, *The New Testament in Cadenced Form* was published.

The Graphic Arts Research Foundation, under contract from the United States Government, is designing and building a machine for the composition of Chinese.

Airborne Instruments Selects Horvath

AIRBORNE Instruments Laboratory has added William J. Horvath to the staff of its medical physics group. Dr. Horvath will assist in the continuing development of the cytoanalyzer—an electronic instrument designed for extensive testing for early cancer—and on other problems of medical physics.

In 1945, he helped organize the Navy's Operations Evaluation Group, and later was deputy director of the group for two years. In

MOLDED OPEN TYPE TRANSFORMERS THE CLIPPER SERIES

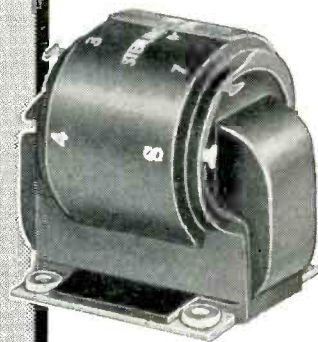

Built to pass MIL-T-27 specifications, including Grade I humidity tests, and to operate continuously at 150° C (Class C).

Result: Savings up to 50% in space and weight without sacrifice in performance.

**SAMPLES?
SPECIALS?
SHORT RUNS?**

The Clipper is only one of the many types we make. We specialize in custom-built transformers to your specifications. Let our engineering staff help solve all your transformer problems.

*Samples delivered in
1 to 3 weeks*

Write for Literature

**STERLING
TRANSFORMER
CORPORATION**

297 North 7th St.

Brooklyn 11, N. Y.

STagg 2-4200

Want more information? Use post card on last page.

1949, he joined the newly organized Weapons System Evaluation Group of the Joint Chiefs of Staff, in which he served for three years as a project leader and in an advisory capacity to the director. Although he resigned from full-time service with the group in 1952, he continued as consultant. He also served as consultant to the National Research Council Committee on Undersea Warfare.

Phaostron Changes Its Name

THE PHAOSTRON Company of South Pasadena, Calif., makers of electrical measuring apparatus, is changing its name to Phaostron Instrument & Electronics Co.

The firm plans to minimize its output of products for military use, and is converting to consumer items.

It plans to add 13,000 sq ft of factory space to its present facilities.

Logistics Research Promotes Two

W. V. NEISIUS, formerly director of applications, has been appointed vice-president of applications and sales, and A. Y. Baker, formerly chief engineer, is appointed vice-president, development and production, of Logistics Research.

Both Neisius and Baker have been with Logistics since before the first production ALWAC computer was delivered in February, 1954. Neisius is former assistant professor of mathematics at Georgia Institute of Technology, and statistical and engineering consultant to the Georgia Power Co. Baker held various positions in radar engineering with aircraft manufacturing firms before entering the electronic computer field.

General Devices Appoints Engineering Head

EVERETT B. GARRETSON has been appointed to the newly created position of director of engineering of General Devices of Princeton, N. J. General manufactures high speed

**ELIMINATE REJECTS!
MINIMIZE BREAKAGE!**

Use *Bird* jewel assemblies

Why chance rejects and breakage that add to production costs when you can eliminate these time-wasting "headaches" with Bird complete jewel assemblies — ready to install in your equipment. Bird's many years of precision production mean jewel bearings of the highest quality. These jewels are set according to your specifications by skilled craftsmen, in less time, for less money, and eliminate special set-ups in your plant.

Why not bring us your jewel problems — you specify — Bird will supply assemblies that fit your product and schedule. Our engineering staff is at your service for all your jewel bearing problems.

For information on jewel assemblies write for Bulletin 15.
Over 40 years of serving industry with Quality jewel bearings

Richard H. Bird & Co., Inc.
Sapphire and glass jewels · Precision glass grinding · Ferrite precision products · Sapphire styli
1 Spruce Street, Waltham 54, Mass.

NEW UHF MEGACYCLE METER

With the Widest Frequency Coverage in a Single Band

FEATURES

- Excellent coupling sensitivity.
- Fixed coupling point.
- Small grid current variation over band.
- Calibration point every 10 Mc.
- Uses split-stator tuning condenser with no sliding metal contacts.
- Standard camera socket for tripod fixtures.
- Octagonal case for convenient positioning.
- Useful in television transmitting and receiving equipment.

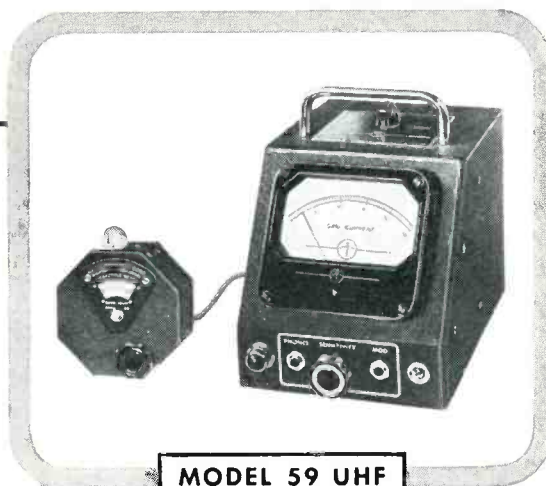

MODEL 59 UHF

SPECIFICATIONS

FREQUENCY RANGE: 420-940 Mc in a single band
 FREQUENCY ACCURACY: ±2% (Individually calibrated)
 OUTPUT: CW or 120-cycle modulation
 POWER SUPPLY: 117 volts, 60 cycles, 30 watts
 DIMENSIONS: Oscillator Unit 4 3/8" x 2 1/2"
 Power Unit 5 1/8" wide x 6 1/8" high x 7 1/2" deep

Laboratory Standards

MEASUREMENTS CORPORATION
BOONTON · NEW JERSEY

IMPEDANCE COMPARATOR

MODEL 1010

FOR LABORATORY AND PRODUCTION IMPEDANCE TESTING



- Tests Resistors, Condensers, Inductors
- Percentage Deviation From Standard Read On Large Meter
- Rapid Response — No Buttons To Push
- High Accuracy And Stability
- Self Calibrating — Requires No Recalibration When Changing Ranges

PRICE
\$29900
F.O.B.
NEW YORK

SPECIFICATIONS

Bridge Supply Volts..... 2 volts
 Component Voltage At Balance... 1 volt
 Frequency Either 1,000 C.P.S., or 10,000 C.P.S.
 Full Scale Ranges . . . ± 5%, ± 10%, ± 20%
 Component Test Ranges:
 Resistance --- 5 ohms - 5 megohms
 Capacitance --- 50 mmf - 20 mfd
 Inductance --- 100 microhenry - 80 henries
 Power Supply --- 105 - 125 volts, 60 C.P.S.

Representatives in Principal Cities

INDUSTRIAL TEST EQUIPMENT CO.
 55 EAST 11th STREET • NEW YORK 3, N. Y.

Manufacturers of:

- PHASE METERS
-
- NULL DETECTORS
-
- IMPEDANCE COMPARATORS
-
- POWER OSCILLATORS
-
- VACUUM TUBE VOLTMETERS
-
- FREQUENCY STANDARDS
-
- AUTOMATIC HI-POT
-

Other Electronic Test Equipment

PLANTS AND PEOPLE

(continued)

multi-contact, sampling switches.

For the past five years, Garretson has been president of his own consulting engineering firm.

Previously, he had been a staff member of the Princeton University plastics laboratory developing apparatus for measuring the dielectric constant and loss factor of plastics and oils at microwave frequencies.

Navy Needs More Engineers

AT THE Naval Air Material Center in Philadelphia, engineering vacancies exist in the following options: electrical, electronics, general, industrial, mechanical, structural and aeronautical. Starting salaries range from \$3670 to \$8990 per annum.

Canadian IRE Sets Show Plan

PLANS are under way for the Canadian I.R.E. Convention which will be held in Toronto on October 1, 2 and 3, 1956.

In addition to the technical sessions at which papers on subjects in the electronics field will be presented, an engineering exhibition will feature upwards of 200 exhibits.

The convention which is expected to draw engineers from all parts of Canada and the adjacent States, will be held in a new building to be erected at the Canadian National Exhibition.

Armco Steel Names Three

G. H. COLE, former associate director of research, has been named consulting engineer for magnetic materials at Armco Steel Corp.

Cole joined the firm's research organization in 1929. He had been an associate director of research for the company since 1931.

V. W. Carpenter succeeds Cole and will direct Armco's future research work in the field of magnetic materials. He joined the company in 1930. In 1940, he became supervising metallurgist and held that position until his recent advance-

TELEPHONE REPEATER TYPE TA-289/FCC

This is a packaged voice-frequency repeater adapted for use on almost any type of two-wire or four-wire line facility. The principal components are amplifiers, hybrid circuits and balancing networks. It also includes line protectors, monitoring telephone set, d-c telegraph composite sets, adjustable line equalizers, v-f signal converter type CV-339/FCC, and rectifier for a-c operation. It has a maximum net gain of 24 db on 2-wire circuits and of 30 db on 4-wire circuits, between nominal 600 ohm impedances.

Type TA-289/FCC Repeater, Telephone, manufactured for the U.S. Army Signal Corps. This is a recent redesign of the type OA-7/FC Repeater, Telephone, and is moisture- and fungus-proofed. It meets all applicable MIL specifications.

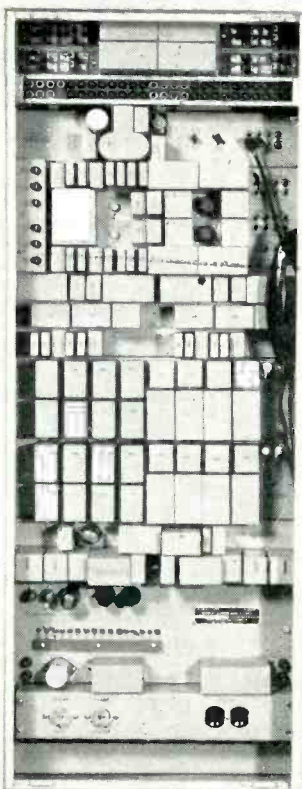

RADIO ENGINEERING PRODUCTS

1080 UNIVERSITY STREET, MONTREAL 3, CANADA

Telephone: UNiversity 6-6887

Cable Address: Radenpro, Montreal

MANUFACTURERS OF CARRIER-TELEGRAPH, CARRIER-TELEPHONE AND BROAD-BAND RADIO SYSTEMS

Let's face it!

HAVE YOU A DISASTER PLAN FOR YOUR PLANT?

BOMBS...OR FIRE...OR FLOOD...OR TORNADO ... you can handle them if you act now.

Let's face it... the threat of war and the atomic bomb has become a real part of our life—and will be with us for years. Fires, tornadoes and other disasters, too, can strike without warning.

Whatever the emergency is, everybody's going to want help at the same time. It may be hours before outside help reaches you. The best chance of survival for you and your workers—and the fastest way to get back into production—is to know what to do and be ready to do it. Disaster may happen TOMORROW. Take these simple precautions TODAY:

- Call your local Civil Defense Director.** He'll help you set up a plan for your offices and plant—a plan that's safer, because it's integrated with community Civil Defense action.
- Check contents and locations of first-aid kits.** Be sure they're adequate and up to date. Here, again, your

CD Director can help. He'll advise you on supplies needed for injuries due to blast, radiation, etc.

- Encourage personnel** to attend Red Cross First-Aid Training Courses. They may save your life.
- Encourage your staff and your community** to have their homes prepared. Run ads in your plant paper, in local newspapers, over TV and radio, on bulletin boards. Your CD Director can show you ads and official CD films or literature that you can sponsor locally. Set the standard of preparedness in your plant city. There's no better way of building prestige and good community relations—and no greater way of helping America.

Act now . . . check off these four simple points . . . before it's too late.



here's what **DIE CAST**
GRC ZINC ALLOY
 THREADED
FASTENINGS
 mean to you...

in terms of a better product, in
 terms of a more economical product!

Gries' unique techniques make possible closer tolerances, cleaner threads, greater dependability, durability, die cast uniformity. Mass production means lower costs!



NEW BULLETIN AVAILABLE!
 Fact-packed—shows how Gries ingenuity and money-saving methods can solve your fastenings problems.

Send today for your copy, prices and samples.

GRIES REPRODUCER CORP.

151 Beechwood Ave. • New Rochelle, N. Y.
 Phone: NEw Rochelle 3-8600

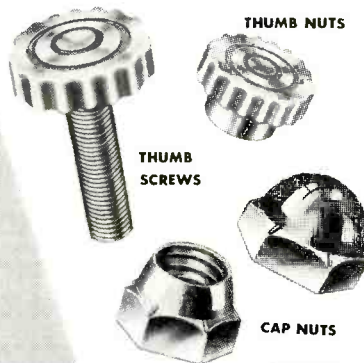

THUMB SCREWS

CAP NUTS

World's
 Foremost
 Producer of
 Small
 Die Castings



ment in research.

D. C. Dieterly has been appointed supervisor of the firm's magnetic research laboratory.

Anderson Leaves Panellit

RALPH A. ANDERSON has resigned as vice-president in charge of design and development engineering of Panellit of Skokie, Ill.

Budd Enters Radiography Field

THE BUDD Co. of Philadelphia will manufacture, sell and service the gamma radiography equipment and sources previously produced by The Gamma Corp. of Mansfield, Mass.

A. J. Stevens, formerly president, C. F. Thompson, formerly vice-president and T. W. Healy, formerly treasurer of the Gamma Corp., have joined Budd and will continue their activities in connection with isotope radiography equipment, as well as other applications of nuclear radiation.

Chassis Company Enlarges Quarters

CALIFORNIA Chassis Co. of Lynwood, Calif., has added approximately 10,000 sq ft to the floor area of its main plant.

The annex will be used mainly for research facilities and warehousing. It will release space in the original building for additional production line operations.

Fua Heads ETL's Expanded Lab

ELECTRICAL Testing Laboratories, independent testing organization, has expanded its facilities and personnel for testing in the field of electronics. Its electronic laboratory now occupies approximately 5,000 sq ft of the 100,000 sq ft, 8-story building owned by E. T. L., and has a staff of fifteen.

Dr. Frederic Fua is director of the electronics lab. He is also president and research director of Stand-

IF IT'S NEW ... IF IT'S NEWS ... IT'S FROM **ELCO**

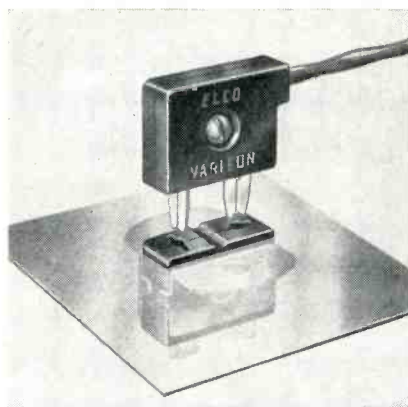

Figure A.

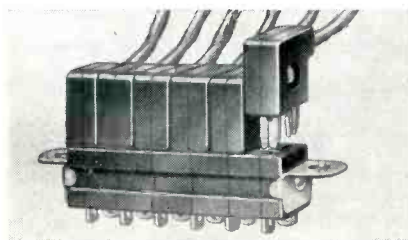

Figure B.

NEW RIGHT-ANGLE VARICON INTRODUCED

ELCO announces a new Right-Angle Varicon as the latest newsworthy addition to its world-famous line of miniature connectors. The new Right-Angle Varicon (Fig. A) available in 2-contact male plugs, makes it possible to run wires or cable parallel to panel, thus conserving space. Units may be plugged into mating portion of connector, side by side. (Fig. B).

Insulator acts as strain relief for cable, permitting exertion of heavy forces without breaking connections. Plugs are polarized the same as other standard Varicons; with the same high current and voltage rating, low resistance, low capacitance.

For further information, or a copy of the new Varicon Catalog V-2, please write us on your company letterhead.

ELCO CORPORATION, M STREET BELOW ERIE, PHILA. 24, PA., CU 9-5500

Electrical Indicating Panel Meters and Pyrometers

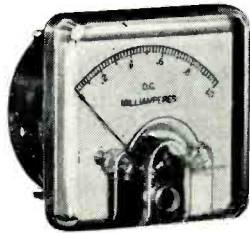

Model 261
shown,
Price \$11.50

White-face,
Black-face, or
Colored Dials.
Can be cali-
brated in any
units: (Amps,
KV, FPM,
Angstrom Units)

Pyrometers are medium resistance (4 ohms per millivolt). Accuracy 2%. Automatic, bimetal cold junction correction. Compensated for copper error. (Ranges from -400 to +3000°F.)

Large dial area—clearly visible. Less waste panel space. Easily lighted transparent plastic front and case. Anti-static treated. Tubing pointer normally supplied. Knife-edge and other types available. D'Arsonval movement in Alnico permanent magnet. Snap-fit construction, virtually dust-tight case. AC meters are rectifier type. Model 451 is 4½"; Model 351 is 3½"; Model 261 is 2½". Meters with Zero Right, Zero Center or up to two-thirds of range suppressed can be supplied. AC and DC in multiple ranges. Meter ranges: DC or AC 0/20 Microamps to 0/50 Amps. 0/5 Millivolts to 0/500 Volts. (Minimum AC Range 0/250 Milli-



volts). Panel meters and pyrometers with black Bakelite cases also available. Model 301 shown. Write for Bulletin G-9 Assembly Products, Inc., Chesterland 4, Ohio. Phone: (Cleveland, O.) HAmilton 3-4436. Atomic Exposition, Booth 423. Dec. 10-16, Cleveland, Ohio

Scouting for Incapsulated Coils?



DANO MAKES THEM!

Dano, makers of a wide variety of coils, is fully equipped to meet the increasing demand for these special coils. Keeping pace with modern design, Dano offers incapsulated coils with tough, molded covers that spell extra electrical insulation with freedom from moisture.

Every Dano Coil is custom-made to your specific requirements. Call or write today, and Dano's quote will be on the way!

- Incapsulated Coils
- Form Wound
- Bakelite Bobbin
- Cotton Interweave
- Paper Section
- Acetate Bobbin
- Coils for High Temperature Applications
- Also, Transformers Made To Order

The **DANO** Electric Co.
MAIN ST., WINSTED, CONN.

Want more information? Use post card on last page.

November, 1955 — ELECTRONICS

PLANTS AND PEOPLE

(continued)

ard Electronics Research Corp. of New York City. The lab is now equipped to test a wide range of electronic equipment.

Waldman Named By Telectro

EDWARD WALDMAN, formerly director of purchases, has been named plant manager for the Telectro Industries Corp., of Long Island City, N. Y., manufacturers of tape recorders and precision electronic devices.

Waldman joined Telectro Industries as an engineer in 1949. Later he was transferred to the purchasing department where he served as director of purchase prior to his new appointment.

American Buys R-C Instrument

AMERICAN Electronics of Los Angeles, manufacturers of equipment for the electronics industry, will enter the nuclear instrumentation market with the purchase of R-C Scientific Instrument Co. of Playa Del Ray, Calif.

An exchange of 13,500 common shares of American Electronics for the total assets of R-C Scientific will be made. R-C sales for 1954 were about \$300,000. American Electronic sales, for the first six months of this year, netted over \$3 million.

The R-C Scientific Instruments Company designs and manufactures nuclear instruments.

The firm will be operated as a wholly-owned subsidiary under the name of Reed-Curtis Nuclear Industries.

Appoint Staff for Geophysical Year

SECRETARIAT of the U. S. national committee for the International Geophysical Year now includes: executive secretary, Hugh Odishaw; administrative officer, R. C. Peavey; program officer, G. F. Schilling. Dr. Joseph Kaplan is chairman of the committee.

The International Geophysical Year program, a study of man's physical environment, will take place in 1957-58. More than forty



MODEL MH15A For mounting on drums having as few as 30 channels or as many as several hundred. Simple Design—Flexible Operation—Low Noise—High Voltage Insulation. Moisture Proof unit completely encapsulated.

CHARACTERISTICS

Recording System; Non-return to zero. Drum Speed; 2300 in. per sec. Writing Current; 70 ma. Cell Density; 100 bits per in. Head to Drum Spacing; .001 inch. Drum Coating; Red oxide, .001 in. thick. Output; 1 volt peak to peak. Track Width; .125 in. Core Width; .090 in.

The performance characteristics of Model MH15A can be incorporated in the MH10A case if desired.

LIBRASCOPE READ-RECORD HEADS

Specifically Designed for Reading or Recording on Magnetic Drum Memory Systems

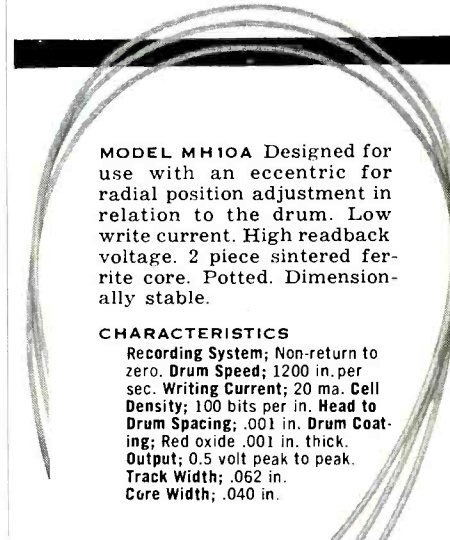

MODEL MH10A Designed for use with an eccentric for radial position adjustment in relation to the drum. Low write current. High readback voltage. 2 piece sintered ferrite core. Potted. Dimensionally stable.

CHARACTERISTICS

Recording System; Non-return to zero. Drum Speed; 1200 in. per sec. Writing Current; 20 ma. Cell Density; 100 bits per in. Head to Drum Spacing; .001 in. Drum Coating; Red oxide, .001 in. thick. Output; 0.5 volt peak to peak. Track Width; .062 in. Core Width; .040 in.

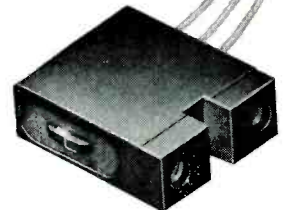

Other models available...
write for brochure.

LIBRASCOPE

A SUBSIDIARY OF GENERAL PRECISION EQUIPMENT CORPORATION

808 WESTERN AVENUE • GLENDALE, CALIFORNIA

Want more information? Use post card on last page.

Make a **GM** PORTABLE D'ARSONVAL
GALVANOMETER

*the Heart
of Your
Instrument*

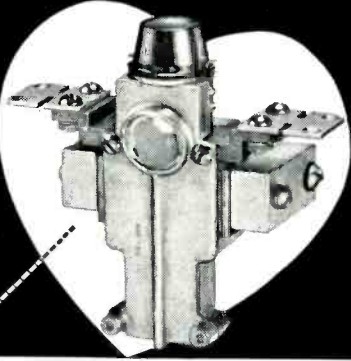

IN THE AUTOMOTIVE FIELD, the Bear Manufacturing Co. of Rock Island, Ill. uses Series 500 G-M Galvanometers in its new remote-reading Electric Wheel Alignment System (left). Whatever your own particular instrument field, you can achieve this same self-contained portability, ruggedness and high sensitivity with G-M Galvanometers. Complete catalog on request.

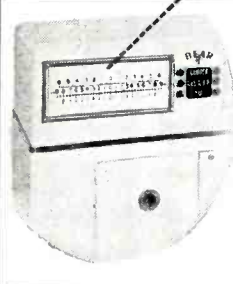

GM LABORATORIES • INC.
 4236 NORTH KNOX AVE., CHICAGO 41

for service and lab. work

Heathkit
 PRINTED CIRCUIT
OSCILLOSCOPE KIT
 FOR COLOR TV!

① Check the outstanding engineering design of this modern printed circuit Scope. Designed for color TV work, ideal for critical Laboratory applications. Frequency response essentially flat from 5 cycles to 5 Mc down only 1½ db at 3.58 Mc (TV color burst sync frequency). Down only 5 db at 5 Mc. New sweep generator 20-500,000 cycles. 5 times the range usually offered. Will sync wave form display up to 5 Mc and better. Printed circuit boards stabilize performance specifications and cut assembly time in half. Formerly available only in costly Lab type Scope. Features horizontal trace expansion for observation of pulse detail — retrace blanking amplifier — voltage regulated power supply — 3 step frequency compensated vertical input — low capacity nylon bushings on panel terminals — plus a host of other fine features. Combines peak performance and fine engineering features with low kit cost!



MODEL 0-10
\$69.50
 Shpg. Wt. 27 lbs.

Heathkit TV
SWEEP GENERATOR KIT
 ELECTRONIC SWEEP SYSTEM

② A new Heathkit sweep generator covering all frequencies encountered in TV service work (color or monochrome). FM frequencies too! 4 Mc — 220 Mc on fundamentals, harmonics up to 880 Mc. Smoothly controllable all-electronic sweep system. Nothing mechanical to vibrate or wear out. Crystal controlled 4.5 Mc fixed marker and separate variable marker 19-60 Mc on fundamentals and 57-180 Mc on calibrated harmonics. Plug-in crystal included. Blanking and phasing controls — automatic constant amplitude output circuit — efficient attenuation — maximum RF output well over .1 volt — vastly improved linearity. Easily your best buy in sweep generators.



MODEL TS-4
\$49.50
 Shpg. Wt. 16 lbs.

Heath
 COMPANY
 A SUBSIDIARY OF DAYSTROM, INC.
 BENTON HARBOR 14, MICH.
 WRITE FOR FREE CATALOG
 ...COMPLETE INFORMATION

nations are participating in the coordinated, simultaneous geophysical investigations. The program of the United States includes the following fields: aurora and airglow, cosmic rays, geomagnetism, glaciology, gravity measurements, ionospheric physics, latitude and longitude, meteorology, oceanography, seismology, solar activity, rocket exploration of the upper atmosphere, and the earth satellite program.

The U. S. national committee for the IGY, established by the National Academy of Sciences, is responsible for the formulation, direction, and execution of the U. S. program. Federal sponsorship and funds have been obtained by the Academy's committee through the National Science Foundation, the government agency responsible for federally supported basic research. To date, the Congress has appropriated \$12 million for the program.

Television Committee Officers Named by AIEE

THE AIEE has named new officers for the committee on television and aural broadcasting systems for the 1955-56 term. They are: chairman: J. B. Epperson, chief engineer of Scripps-Howard Radio & TV., re-appointed. Vice-chairman: C. M. Braum, consultant to the Joint Committee on Educational Television, Washington, re-appointed. Secretary: Carl E. Smith of Carl E. Smith Consulting Radio Engineers in Cleveland. He replaces R. K. Hellmann of Hazeltine Electronics who has resigned to handle another AIEE appointment.

Consolidated Selects Transducer Director

KENNETT W. PATRICK has been appointed director of the transducer division of Consolidated Engineering Corp.

He formerly was director of the firm's systems division. Succeeding him in that post is Harry E. Burke, Jr., who has been assistant director of the division since February, 1954.

Walter B. Claus, who has directed activities of the transducer division the past two years, was assigned to

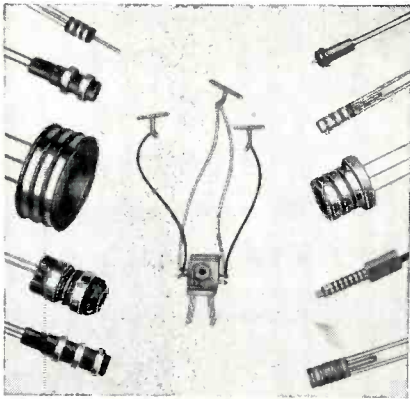

Miniature and Sub-Miniature
SLIP RING ASSEMBLIES
BRUSH BLOCK ASSEMBLIES
COMMUTATORS
 and other
 Electro-Mechanical Components
PRECISION MADE
TO YOUR OWN SPECIFICATIONS

Precision molded products with exacting tolerances in precious and non-precious solid metals of all alloys. All types of Thermo-Plastic and Thermo-Setting materials.

Slip Ring Assemblies fabricated or one-piece precision molded to your specifications in Nylon, Kel-F, Mineral filled Mellamine, Phenolic, and other materials. Rings and leads spot welded or brazed together for positive electrical circuit.

Our Swiss methods and techniques are geared to meet exacting requirements. We invite your inquiries.

COLLECTRON CORPORATION

MUrray Hill 2-8473 • 216 East 45th Street • New York 17, N. Y.

TI-CO WIRE STRIPPER



The TI-CO Wire Stripper completely strips single or multiple leads of fine magnet wire in sizes No. 18 to No. 48; removes all types of insulation, formvar, nyclad, glass, etc., without damage to wire; exceptionally fast, clean stripping with minimum rejects. Speeds up production; guarded machine, safe for operator. Wire diameter kept to within .0002". Machine compact, portable and relatively quiet; rugged; stands up under steady use; precision ball bearings throughout. General-purpose brushes are of fibreglass. Machine can be adapted to strip any coil form. Machine can be adapted to strip wire outside 18-48 range.

PRICE: \$225.00

For additional information write or phone:

THOMAS INSTRUMENT COMPANY

Telephone 5134

PHOENIX, NEW YORK

McGraw-Hill Mailing Lists Will Help You



Mc GRAW-HILL
 DIRECT MAIL LIST SERVICE

- Merchandise your advertising
- Conduct surveys
- Get inquiries and leads for your salesmen
- Pin-point geographical or functional groups
- Sell Direct
- Build up weak territories
- Aid Dealer relations

Direct Mail is a necessary supplement to a well rounded Business Paper advertising program.

Most progressive companies allocate a portion of their ad budgets to this second medium at the same time as they concentrate on the best business publications. 600,000 of the top buying influences in the fields covered by the McGraw-Hill publications make up our 150 mailing lists. Pick Your prospects out of our Industrial Direct Mail catalogue.

Write for your free copy of our Industrial Direct Mail catalogue with complete information.



GLASS WORKING LATHES

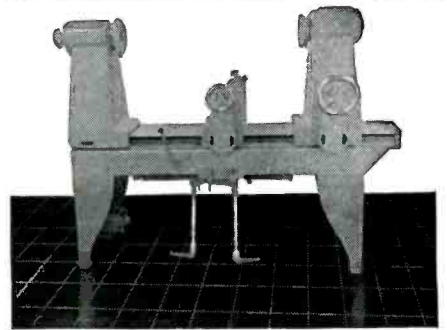

MODEL ME

\$3135.00 f.o.b. Grass Valley, Calif.
 Especially useful for handling large television Bulbs

GENERAL SPECIFICATIONS

Maximum length overall	84"
Maximum width overall	27"
Maximum length, spindle nose to spindle nose	47"
Height, floor to spindle	52 3/8"
Radial clearance above apron	21 1/4"
Spindle hole diameter	3 7/8"
Approximate shipping weight	1800 lbs.
Net weight	1600 lbs.

STANDARD EQUIPMENT

Two face plates
 One collet draw-in bar
 Hand carburetion control
 Foot pedal control of air or nitrogen supply and oxygen-gas volume
 Main air valve controlling air in either or both spindles
 Standard spindle speeds approx. 30-40-60 RPM. (With Adjusto Spede 17 1/2-175 RPM.)
 1/2 h.p. motor, 220 volt, 3-phase

DO YOU KNOW?

That a first class glassblowing job requires accurate alignment of rotational axes between the headstock and footstock?

That variable spindle speed gives another dimension to your technique?

That simple chucking attachments supply versatility for wide varieties of applications?

That special chucking for your industrial procedures, or laboratory practices are available?

That Litton jet-mix fires are universally used in glassblowing to prevent reducing conditions?

That Litton Lathes have been the standard of the vacuum tube industry for 22 years, and have been constantly improved?

That you can get these precision tools at reasonable cost, in eight sizes, with swing from 8" to 42", and working length from 20" to 75 1/2"?

Let us send you complete specifications and prices on our line of equipment and tools for the Vacuum Tube industry and for general research and development laboratory use.

3238



Litton Engineering Laboratories
 Grass Valley, California • P. O. Box 949

DataReader

Model 546

A transport unit for high-speed searching, reading and recording of data on magnetic tape.

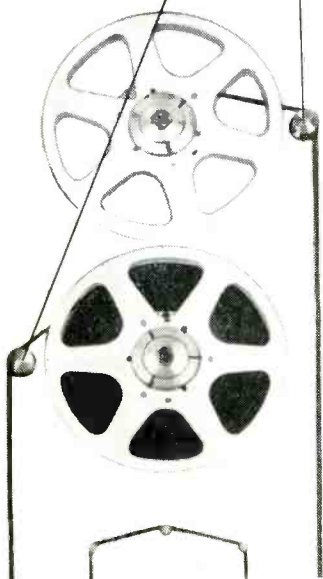
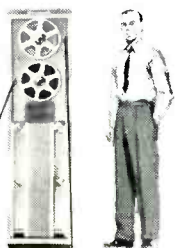

End-of-tape sensing

Slotted, hollow guide shafts, one adjacent to each tape reel are constantly subjected to a vacuum which is maintained as long as normal tape is passing over, and sealing the shaft openings. Perforated leaders at either end of the tape interrupt the vacuum and stop the tape reels. This feature also provides an automatic stop in the event of tape failure.

PERFORMANCE:

- RAPID START—STOP—REVERSE**—from stop to full speed in 6 milliseconds.
- HIGH TAPE SPEED**—optional single speed of 30, 40, 50, 60 or 75 in/sec.
- TWO-DIRECTION SEARCH**—either direction, automatically at full speed.
- REMOTE OPERATION**—forward, reverse, stop, rewind and selection of reading and writing.
- VACUUM COLUMN TAPE CONTROL**—provides strain-free tape feed over entire length of tape.
- RAPID REWIND**—2400 ft. of 1/2" or 3/4" tape in 3 minutes.

FOR FURTHER INFORMATION WRITE
ElectroData Corporation
Component Sales Division
460 No. Sierra Madre Villa
Pasadena 15, Calif.

ElectroData

An Affiliate of
CONSOLIDATED ENGINEERING CORPORATION
OF PASADENA, CALIFORNIA

ElectroData Corporation maintains a nationwide sales and service organization.

Want more information? Use post card on last page.

undertake several special projects for the manufacturing division.

Rea Names Magnetic Head

FRANCIS A. OLIVER has been appointed as manager of the newly created data storage devices unit of the J. B. Rea Co. of Santa Monica, Calif.

The new unit will be responsible for the development and manufacture of magnetic storage components, including magnetic heads and drums, magnetic tape recording machines, magnetic core "matrix" memory systems and dielectric storage elements.

Oliver, designer of the new magnetic components, was formerly head of research and development of magnetic storage devices at National Cash Register's electronic division. Prior to that he headed a similar division at the computer division of the Bendix Aviation Corp.

Hall-Scott Buys Another Electronics Firm

HALL-SCOTT Motors Co. of Berkeley, Calif., has acquired its second electronics firm—Dynamic Analysis Co., of Los Angeles.

The Los Angeles firm has developed a desk model computer, for which Hall-Scott acquired manufacturing rights.

Dynamic Analysis will be integrated with Hall-Scott's electronics division in Burbank. This newly-acquired division, formerly known as Bardwell & McAllister, does electronics work for guided missiles and radar, and also has contracts with the Atomic Energy Commission.

The new firm was acquired through outright purchase.

Two Engineers Join Stanford Research

RICHARD K. THOMAS and Robert F. Trainer, both from Johns Hopkins University laboratories, have joined

NOW!
a practical engineering
introduction to

COLOR TV



Here is practical grounding in the complex techniques of color television for engineers and technicians already familiar with monochrome television. The book takes you from basic principles of color and color sensation, right through to the actual transmitters, studio equipment, and receivers reproducing a color show in the set-owner's home.

Features approved, commercially important fundamentals

Just Published!

COLOR TELEVISION Engineering

By John W. Wentworth
Manager, Television Terminal Equipment Engineering, Radio Corporation of America
448 pages, 6 x 9, 296 illustrations, \$8.00

Color television is explained in simple and largely non-mathematical form. The block diagram approach is used extensively, and step-by-step derivations lead you gradually from familiar principles of monochrome television to the advanced techniques of color television. The book reviews the basic theory of color, and the problems involved in transforming color images into electrical signals, then back again into color images. Various electronic techniques used for processing, multiplexing, and transmitting color television signals are discussed in an orderly sequence.

Covers these 4 main areas

- ▶ Basic principles of color, color perception, and color measurement
- ▶ Principles of color reproduction, covering the application of colorimetry to color television
- ▶ Principles of color television transmission systems, including multiplexing techniques, sequential color television systems
- ▶ Apparatus and circuits for color television, covering transmitters, receivers, and test equipment

Contains these useful appendixes

- Standardized CIE Colorimetric Data
- Data for Color Mixture Curves for the FCC Primaries
- FCC Standards for Compatible Color
- Television Trigonometric Identities
- Mathematical Proof of the Two-Phase Modulation

10 DAYS' FREE EXAMINATION

McGraw-Hill, Attn: H. Buhrow
Industrial & Business Book Dept.
327 West 41st St., NYC 36

Send me Wentworth's PRINCIPLES OF COLOR TELEVISION ENGINEERING for 10 days' examination on approval. In 10 days I will remit \$8.00, plus few cents for delivery costs, or return book postpaid. We pay delivery cost if you remit with this coupon; same examination and return privilege.

PRINT
Name
Address
City Zone State
Company
Position

For price and terms outside U. S., write McGraw-Hill, Int'l., N. Y. C. L-11

Want more information? Use post card on last page.

the Mount Lee laboratory of Stanford Research Institute as electronics research engineers.

They will take part in the microwave testing program carried on at the research center.

Thomas was for three years a group leader in electronics countermeasures research and development at the University's radiation laboratory in Baltimore. He has previously supervised an antenna group with Bendix Radio, and developed vhf and microwave antennas at Airborne Instruments Laboratory in Mineola, N. Y.

Trainer was formerly a staff assistant in the John Hopkins Applied Physics Laboratory at Silver Springs, Md. He has conducted research in antennas and transmitters as well as electronic and pulse circuitry.

Army Ordnance Seeks Definitions

THE ARMY Ordnance Corps is preparing an ordnance engineering design handbook to summarize fundamental principles and basic design data. So as to avoid confusion as to the meaning of terms as used in ordnance engineering and as used in other fields that ordnance cuts across, aid is sought from all engineers with information on technology and nomenclature problems. Information should be sent to the Center for Documentation and Communication Research, School of Library Science, Western Reserve University, Cleveland 6, Ohio.

Sunstein Establishes New Company

A NEW company known as Sunstein Engineering Co. has been formed in Bala Cynwyd, Pa., to provide consulting services in the electronics field.

The firm is headed by David E. Sunstein, formerly assistant technical director of research for Philco Corp. His employment prior to the formation of this new company was entirely with Philco Corporation, the first five years of which were spent in the factory, and the last ten years in the research division. Prior to his position as assistant



FSS

FREQUENCY SHIFT SIMULATOR



- A PRIMARY SOURCE OF CONTROLLABLE FREQUENCY SHIFT SIGNALS
- ADJUSTABLE FREQUENCY SHIFT RANGE ± 10 cycles to ± 5 kilocycles
- CENTER FREQUENCY ADJUSTABLE 400 CYCLES TO 16 KILOCYCLES
- ADJUSTABLE PULSE GENERATOR PROVIDES KEYING TO 600 DOT CYCLES
- BIAS CONTROL PROVIDES UP TO 50% MARK OR SPACE BIAS
- WILL ACCEPT EXTERNAL MARK/SPACE PULSES OR LINEAR SIGNALS (FAX)
- INTERNAL SWEEP GENERATOR SIMULATES FAX SIGNALS AND PRODUCES LINEAR SWEEP FOR VISUALLY CHECKING AUDIO AMPLIFIERS, DISCRIMINATORS AND FILTERS
- INTERNAL MIXER SYSTEM PERMITS CHECKING OF EXTERNAL FREQUENCY SHIFT DEVICES
- AVAILABLE WITH CABINET OR FOR RACK MOUNTING
- REQUEST BULLETIN 171

CPR-90
COMMUNICATIONS RECEIVER

GPT-750
RADIO TRANSMITTER

PMO
MASTER OSCILLATOR HETERODYNE FREQUENCY METER

... and many other items of fine communications equipment. Bulletins on request.

The TECHNICAL MATERIEL CORPORATION

IN CANADA: TMC Canada, LTD. OTTAWA, ONTARIO

MAMARONECK, NEW YORK

Use "Unusable" Spaces with this

SUBMINIATURE RECEIVER and POWER SUPPLY



Our Model 128 subminiature power supply (left) is designed to provide B + and filament voltages to various equipments. Being extremely compact (1" x 3" x 9") it may be mounted in inaccessible or normally unusable spaces. Lightweight (only 36 oz.), it has been ideal for critically balanced airborne devices. Consider it for your applications. The model 127 VHF receiver, as shown at right, incorporates modular design for flexibility of installation as one unit or separated for better space utilization. Wideband characteristics and module size (1" x 3" x 9") permit application in all fields of instrumentation and communication—airborne or otherwise. This receiver features crystal frequency control plus excellent sensitivity, quieting and noise rejection. Send the coupon below today for our Data Sheets 100 and 101 which give detailed specifications on this versatile equipment.





Instrument and Electronic Division
Oakland Int'l. Airport Oakland 14, Calif.
Subsidiary of California — Eastern Aviation, Inc.

Send me Data on your Subminiature Equipment:

Name

Address

City State

I found it!

say leading design and development engineers . . .

ACEPOT

the smallest wire-wound precision potentiometer

1/2" Size—Linearity .3%—High Resolution—200— to 100K*

torque: .035 oz./in. @ 20° C.
power rating: 2 watts for 60° C. rise
meets applicable portions of MIL-E-5272A standards

ambient temperature: —55° C. to 125° C.

*Resistance Range: 200 ~ to 100K standard, ± 2%. Higher or lower on special order.

Standard, servo or flush mountings . . . dual or up to 6-gang units.

The case and threaded mounting bushing is one-piece anodized aluminum for maximum heat dissipation. The shaft is centerless ground stainless steel. Standard bearing in aluminum or bronze insert. Available for lower torque requirements with ball or jewel bearings. All units fully sealed, moistureproofed, fungicide treated.

Our unique manufacturing and testing facilities assure you of controlled quality. Each ACEPOT is performance tested and a Polaroid picture record is supplied showing linearity and resolution.

Send for specification sheet, application data sheet and prices. Your inquiry will receive prompt attention.

ACE ELECTRONICS ASSOCIATES

125 Rogers Avenue, Somerville 44, Mass.

ACEPOT, ACETRIM trademarks applied for.

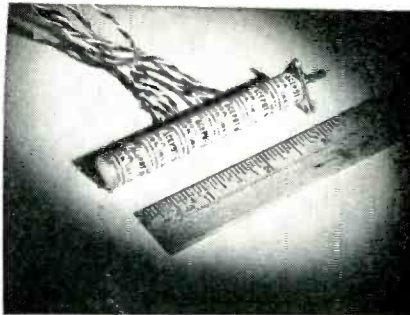

Available single or up to 6-gang units or case sheet

ACETRIM

1/2" size
linearity 3%
10 ~ to 50 K ± 5%

ACETRIM . . . a low-priced, sub-miniature trimmer potentiometer with the same fine characteristics as the ACEPOT. Meets MIL standards. Available standard or shaft lock. Stops if required.



technical director of research, he served as director of government research activities.

Wheeler Laboratories Promotes Williams

FRANK H. WILLIAMS has been appointed assistant chief engineer of Wheeler Laboratories in Great Neck, N. Y., and elected to the board of directors of the firm.

He has a background of experience in the field of radar, with previous employment of several years at Hazeltine Electronics Corp.

During the six years since he joined Wheeler Laboratories, Williams has been in charge of several radar projects. In his present capacity, he will participate in the direction and management of the staff of twenty engineers working on problems of radar, antennas and microwaves.

Washington Forms Electronics Division

A NEW division for the engineering and manufacture of electronic and electro-mechanical devices and systems has been formed in Minneapolis by Washington Machine and Tool Works.

The new division, General Components Co., will be under the direction of Ivan C. Pedersen and Karl Schurr. Precision rotary and linear-travel potentiometers are among the first products to be marketed.

Pedersen has most recently been at Minneapolis-Honeywell, aeronautical division, working on helicopter autopilots. Previously, he was with Zenith Radio Corp. in radar development and Amphenol in high frequency cable development.

Schurr has most recently worked as project engineer at Minneapolis-Honeywell on the E-10 autopilot. Previously, he was with Victor Adding Machine Corp. as senior technical representative.

Plans are proceeding for purchase or construction of a new building to house the expanded facilities of the company.

PRECIOUS METAL WIRES
Produced in Platinum, Gold, alloys and pure metals—small diameter . . . Platinum alloy resistance wires . . . Pure Iridium and Rhodium-Iridium alloy Thermo-couple Wire.

COATED WIRES
Comprising an extensive range of electroplated grid wires . . . Enamel insulated wires for precision resistors and potentiometers.

BASE METAL WIRES
Very small diameter—for filaments, thermo-couples, resistance units.

Metallurgists & Specialists in Small Wire

Serving Industry—
FOR OVER 53 YEARS

Write for Latest List of Products

SIGMUND COHN CORP. 121 So. Columbus Avenue • Mount Vernon, N.Y.



FIVE STAR ELECTRICAL COMPONENTS



COILS
Wound to Your
Specifications

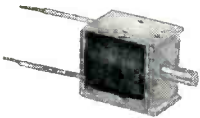

SOLENOIDS
Light
and Miniature
Types



RELAYS

Power and
Sensitive
Types



Send for catalog sheets describing these items in detail. Prompt quotations will be furnished on receipt of your complete specifications and requirements.

THE FIVE STAR COMPANY
10 WEST MAIN STREET
PLANTSVILLE, CONN.

New Books

Sonics: Techniques for the Use of Sound and Ultrasound in Engineer- ing and Science

By THEODOR F. HUETER AND RICHARD
H. BOLT.
John Wiley & Sons, Inc., New York,
456 p, \$10.00.

THIS BOOK, intended to bring
the engineer up to date in the
applications of sound energy to in-
dustrial processes, also contains

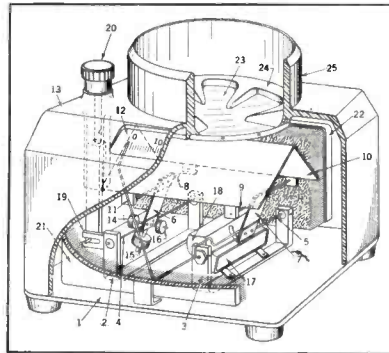

Ultrasonic power meter

enough fundamental information to
serve as a college text in the sub-
ject.

The authors have attempted to
deal with the field of acoustic vibra-
tion as a unit, without separating it
into arbitrary categories of sub-
audible, audible and ultrasonic. The
title "Sonics" is defined as "the
technology of sound as applied to
problems of measurement, control
and processing."

Chapter divisions include basic
physical principles of sound, radia-
tion of sound energy and design of
transducers. In the practical-appli-
cations chapters the use of sonic
energy for processing and testing
of liquids and solids is discussed.
Techniques of nondestructive test-
ing are also discussed. In many of
the applications, simplified design
equations are summarized for prac-
tical use.—D.A.F.

Practical Electroacoustics

By M. RETTINGER, *Chemical Publish-
ing Co., Inc., New York,* 271 p, \$10.00.
THE CONCERN of "Practical Elec-
troacoustics", to quote from Mr.



HYCOR TELEMETERING FILTERS

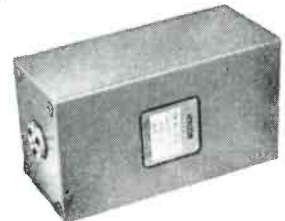

Hycor band-pass and low-pass tele-
metering filters are produced in
exact accordance with accepted
military standards. In addition to
designs which conform to Applied
Physics Laboratory specifications,
miniature units are available.

Hycor Telemetering filters are potted
for complete protection against vi-
bration and humidity. The finest com-
ponents are used to minimize aging
effects on characteristics.

Send for **Bulletin TF** which de-
scribes standard types available.

Hycor engineers will be pleased
to quote on your most exacting
specifications.

*Representatives in
Principal Cities*

HYCOR
Company, Inc.

Subsidiary of International Resistance Company

11423 Vanowen Street
North Hollywood 1, Calif.

Want more information? Use post card on last page.



SPADE BOLTS

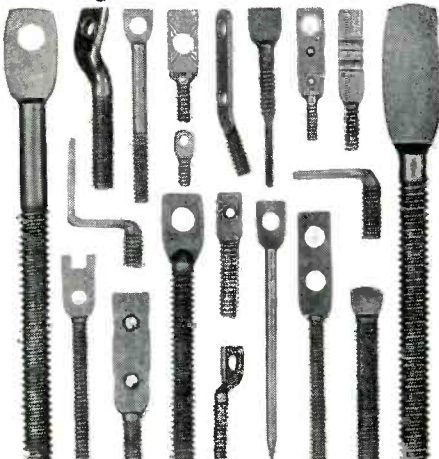

Specialists in designing and manufacturing of all-
purpose fasteners and wire forms. Tooled to pro-
duce over 1000 styles in any screw size, material,
finish, quantity, to your specifications.

Serving Industry for Thirty-five Years
— OTHER PRODUCTS —

Simplex
WIRE STRIPPERS & CUTTERS

• TOOLS • DIES • STAMPINGS
Bulletins on complete line upon request

WENCO MANUFACTURING CO.
1133 W. Hubbard St., Chicago 22, Ill., U.S.A.

Want more information? Use post card on last page.

ELECTRONICS — November, 1955

GATES D.C. POWER SUPPLIES

AIRCRAFT BATTERY ELIMINATOR

- Low ripple
- Good regulation
- Zero maintenance
- Instantaneous starting
- High overload capacity
- Continuous duty ratings
- Rack or bench mounting



MODEL G101F

0-28 VOLTS

@ 20 AMPS.

RIPPLE 1%
(cont.)

PRICE

\$160.00

WRITE FOR BULLETIN NO. 111 FOR COMPLETE SPECIFICATIONS AND DETAILS

GENERAL PURPOSE POWER UNITS

D.C. Output		Catalog No.		Dimensions—In.		
Volts	Amperes	115 VAC 60~1ϕ	230 VAC 60~1ϕ	H	W	D
0-6	25.0	G38	—	9	17	9
	50.0	G47	G48	10	21	15
	100.0	G56	G57	14	21	15
0-12	12.5	G65	—	9	17	9
	25.0	G74	G75	10	21	15
	50.0	G83	G84	14	21	15
0-28	10.0	G92	—	9	17	9
	20.0	G101	G102	10	21	15
	40.0	G110	G111	19	21	15

- Motors
- Relays, Solenoids
- M-G Sets
- Electro-Plating
- Battery Charging
- Contactors, Starters

0-28 Volts @ 40
Amps (cont.)

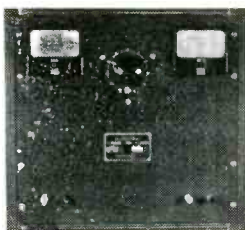

MODEL G 111

WRITE FOR BULLETIN NO. 10 FOR COMPLETE SPECIFICATIONS AND DETAILS

Only a few of our standard models are shown above: Custom-built equipment and variations of our standard design can be readily furnished. Quotations promptly given.



**GATES
ELECTRONIC CO.**

Factory—611 MORRIS PARK AVE., NEW YORK 62, N. Y. • SY 2-3414

Office—2090 BARNES AVE., NEW YORK 62, N. Y. • TY 2-6490

A PRECISION

X-Y

RECORDER

THE MOSELEY AUTOGRAF

trade mark

CURVE DRAWING POINT PLOTTING

CURVE FOLLOWING

MODEL 1.

Drum type, accepts 8½" x 11" graph paper; traverses each axis in 1 second; has full scale ranges of 5 millivolts to 100 volts; zero set anywhere on paper; portable, self-contained; available also as a curve follower for electrical readout of drawn curves.



AUTOGRAF Recorders, MODELS 1 and 2, provide all the features needed for graphic recording of test data, point plotting, and curve following for readout purposes.

MODEL 2

Flat bed type, accepts 11" x 16½" graph paper; same speeds, sensitivities and ranges as Model 1; zero set anywhere on paper plus one full scale length of zero offset; inputs provided for analog recording, point plotting from digital sources, and curve following for computer or data reduction.

Write for bulletins describing these instruments and accessories available for point plotting, curve following, and card translating.



F. L. MOSELEY CO., 409 North Fair Oaks Avenue, Pasadena 3, California

Rettinger's foreword, is "chiefly a description and analysis of audio communication equipment—microphones, moving-coil loudspeakers, mixers, studios, magnetic recording devices, as well as related subjects, such as crossover networks, attenuators, magnets and vibration isolation". It is further stated that "little is said about amplifiers, a discussion of the various types of which would fill several volumes. Not much space has been devoted

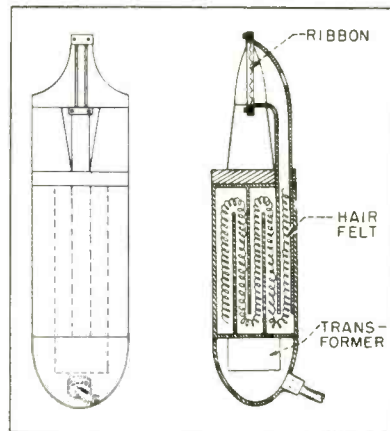

Ribbon Microphone

to acoustic measurements either, as they are well described in the book by Leo L. Beranek of the same title. Architectural acoustics was covered in another book by the author."

Content

Topics are treated in eight chapters under the headings: microphones, loudspeakers, circuits, magnetic structures, public-address systems, vibrations, architectural acoustics and magnetic recording. Inclusion of the chapter on architectural acoustics seems strangely at variance with the intentions expressed in the preface.

The discussion of the characteristics of various types of attenuator networks in the chapter on circuits is a sincere attempt to give the reader at least a taste of the complex of muddled details so characteristic of this subject. The presence of a chapter on public-address systems is also somewhat of an innovation and includes, among other topics, an informal technical history of the Hollywood Bowl sound reinforcement system, which will undoubtedly give pleasure to those readers who enjoy the anecdotal approach, and a detailed exposition

of the electrical impedance matching of various loudspeaker combinations.

Inconsistencies

Although the reviewers cannot claim to have scrutinized the text with the scrupulous care of a proof-reader, they encountered a number of inconsistencies. The most serious criticism of the reviewers is that the text attempts to cover far too much material in far too little space. The author could have devoted the entire text to field applications of electroacoustical equipment and drawn on his extensive experience to discuss in greater detail the proper choice and use of microphones, speakers, magnetic recorders and their associated circuitry in studio recording, public address systems etc. A book restricted to such a choice of topics would have been of considerable value.—E. G. THURSTON, *Armour Research Foundation, Chicago, Illinois* and W. H. PEAKE, *Ohio State University, Columbus, Ohio.*

Color Television Fundamentals

By MILTON S. KIVER. *McGraw-Hill Book Company, Inc., New York, 1955.* 312 p, \$6.00.

FOR those scientifically curious about color television, Mr. Kiver's book is fascinating. First, it attempts to explain colorimetry and second, it deals directly with the specific details of color receiver circuitry. On colorimetry alone the reader appeal is strong for little has been written on it in a popular vein.

This volume represents a fairly complete summary, at the lower engineering level, of the salient facts of current color television; circuitwise, it gives factually accurate descriptions on a great deal of material covering most current color television receiver designs. Although the explanations suffice to introduce the basic principles, the technician will find them generously sprinkled with broad engineering assumptions. Not until the last two chapters do the circuit descriptions and the adjustment procedures reach his industry level and use practical language. In these two

New low-cost
DIGITAL VOLTMETER



SADIC DIGITAL VOLTMETER (TYPE 33-110)

is CEC's newest unit for low-voltage analog-to-digital conversion. It offers true economy plus high accuracy. Output includes illuminated numerical display (above) and decimal-coded contact closures. Suitable for bench use or rack mounting (two units fit side by side in 19" rack) the 33-110 is useful for both laboratory indication and as a building block for automatic data-processing systems.

SPECIFICATIONS

- ... digital range 000 to 999 (1000 steps)
- ... accuracy 1/10th % of full scale
- ... sensitivity 10 millivolts provides full-scale output
- ... balance time 0.8 second, max.
- ... power source 105-115 volts a-c



Send for Bulletin CEC 3009-X3

Consolidated Engineering Corporation

300 North Sierra Madre Villa, Pasadena 15, California

Sales and Service Offices Located in: *Albuquerque, Atlanta, Boston, Buffalo, Chicago, Dallas, Detroit, New York, Pasadena, Philadelphia, San Francisco, Seattle, Washington, D. C.*

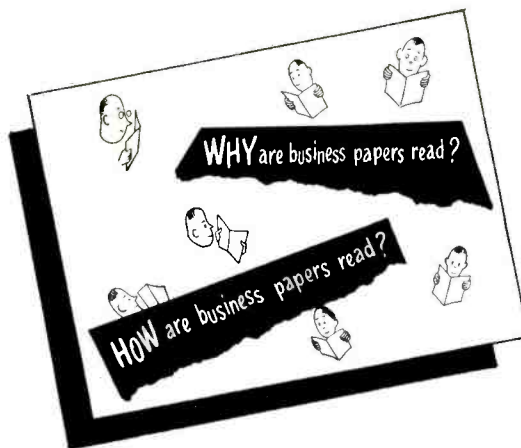

A copy of this quick-reading, 8-page booklet is yours for the asking. It contains many facts on the benefits derived from your business paper and tips on how to read more profitably. Write for the "WHY and HOW booklet."

McGraw-Hill Publishing Company, Room 2710, 330 West 42nd St., New York 36, N. Y.

SWITCHING
SAMPLING
SEQUENCING

HIGH SPEED

Multi-Pole Commutators

Precision, rotary, electro-mechanical switching unit with precious metal contacts for long life, low noise, trouble-free operation. Contact cleaning device extends life, permits low level switching in some applications. Multi-pole units with any number of contacts can be furnished. Switching can be "make before break" or "break before make."



MODEL 85561

Torque: 2 oz. in. or less.
Weight: 4 oz. Will withstand 50G ac. acceleration and operate within specifications at 10G vibration from 55 to 500 cps.
Noise Level: Will not exceed 1.0% of full signal amplitude.

MODEL 85562

Motor driven model. DC governor-controlled constant speed 1/2 to 1800 rpm., or speed varies linearly w/ applied voltage. Other drives available.

Giannini

Product of Electromechanical Division
EAST ORANGE, NEW JERSEY

for information write
G. M. GIANNINI & CO. INC.
PASADENA 1, CALIFORNIA

Want more information? Use post card on last page.
402

chapters the explanations have concrete significance to the fundamental facts and indeed, the text on troubleshooting in Chapter X most specifically reviews and crystallizes the explanations on basic phenomena that have gone before.

The treatment of three-gun color tubes is good. Their basic operation, their inherent characteristics when related to convergence, purity, brightness etc supply a background of information which would have been well located forward in the volume since there it might have contributed some clarity to the discussion on fundamentals. An excellent discussion is given in the chapter on deflection and convergence circuits.

Receiver Circuits

Descriptive color circuitry on current color receivers occupies four complete chapters and forms the basis of the text, using 100 pages of the 300-page total.

The book as a whole constitutes a text on color receiver circuitry at the technicians level; it is a complete compilation, including the engineering type explanations, from popular color television literature appearing over the last three years. It is complete in its coverage and for high level technical usage should prove a valuable source of information.—HARRY E. THOMAS, Senior Project Engineer, Federal Telecommunication Laboratories, Nutley, N. J.

Dielectric Materials And Applications

EDITED BY A. R. VON HIPPEL. *Technology Press and John Wiley, New York, 1954, 438 p., \$17.50.*

THIS book is a companion volume to the one on "Dielectrics and Waves" and is concerned more with the engineering use of dielectric materials rather than the theoretical aspects that were considered in the companion volume. The book consists of a series of contributions from a number of authorities in the field under the editorship of Professor von Hippel who has done an extremely able job in integrating these various contributions into a

...the Answer to better, faster soldering on printed circuits ...



Production Soars
with **KWIKHEAT**
Type 200[®]
Thermostatic Soldering Irons

Because Kwikheat Thermostatic soldering irons are especially designed for the close, tight soldering required for quality electronic equipment, production soars when old-style heavy irons are replaced by light weight (7 1/2 oz.), perfectly balanced, small size Kwikheat Junior Type 200 irons.

Controlled by a sealed, built-in, high temperature thermostat that heats quickly, maintains preset heat (800° for production, 700° for stand-by) Kwikheat irons are economical and long lasting. Current used to maintain heat is only one-third heater capacity. Stainless steel core and tips resist corrosion. Three versatile, plunger type tips are easily changed in the field. Big, easy-to-grip plastic handle is air cooled, has a wide flange to protect hands.



Increase your production. Change to Kwikheat Thermostatic soldering irons today.

KWIKHEAT Manufacturing Co.
3732 San Fernando Rd., Glendale 4, Calif.

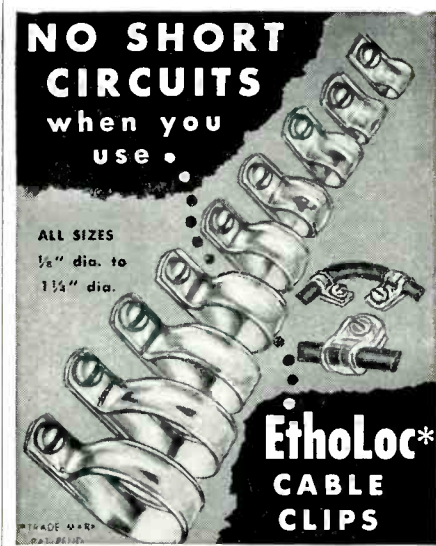

NO SHORT CIRCUITS when you use.

ALL SIZES
1/8" dia. to 1 1/4" dia.

EthoLoc* CABLE CLIPS

Made of ETHYL CELLULOSE...
A TOUGH, DURABLE PLASTIC



Write for Sample and Full Information

WECKESSER CO.

5267 N. AVONDALE AVE. • CHICAGO 30, ILL.

West Coast Representative:
5777 West Pico Blvd. • Los Angeles 19, Calif.

Want more information? Use post card on last page.
November, 1955 — ELECTRONICS

very useful book on dielectrics.

The first section of the book treats the theory of dielectrics. Following this, there is a section on dielectric measuring techniques.

The third section of the book which is concerned with dielectric materials and their applications, is a thorough survey of the various types of materials available.

Following this the fourth section deals briefly with the dielectric requirements of the armed forces.

Engineering Data

The fifth section of the book consists of the tables of dielectric materials which have been issued by the MIT Laboratory for Insulation Research.

All in all, this book is a must to those engineers who are concerned with the use of dielectrics, either in components or in equipments.—HENRY JASIK, *Consulting Engineer, Mineola, New York.*

Elektronische Halbleiter

BY E. SPENKE. *Springer-Verlag, Berlin, 1955, 379 p, DM 34.50.*

THIS BOOK is probably one of the most complete compilations of basic information on the physics of semi-conductors ever written with the exception of Dr. W. Shockley's "Electrons and Holes in Semiconductors".

Prefaced by Dr. W. Schottley, a leading authority in this field, the book is divided into two portions. The first part (chapters I to V) is an accumulation of the author's lectures and is written for students or for those just entering the field of semiconductors.

The second half of the book (chapters VI to X) is intended for the basic study of the physics of semiconductors.

The author has handled his material with skill.

His organization and development of all the chapters is excellent. A bibliography is given at the end of each chapter and affords good references on the material treated. Illustrations are numerous, well chosen and finely reproduced, some in three colors. Treated very comprehensively, the book provides to

NOW AVAILABLE . . . The Welch Duo-Seal Vacuum Pump (Model 1397B) with VENTED-EXHAUST at no increase in price . . .

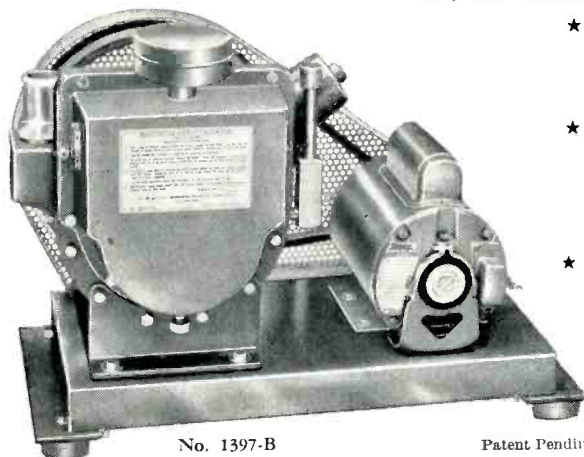

- ★ Vented Exhaust Permits Pumping of Most Condensable Vapors
- ★ Eliminates Use of Traps or Oil Separators in Systems Containing Water or Other Condensables
- ★ Reduces Number of Oil Changes Required

Illustration shows 1397B Duo-Seal Pump equipped with Vented Exhaust.

VENTED EXHAUST IS AVAILABLE ON ALL TWO-STAGE DUO-SEAL® PUMPS

Write for our Complete Catalog listing Duo-Seal® Pumps and Vacuum Accessories

W. M. WELCH SCIENTIFIC COMPANY

DIVISION OF W. M. WELCH MANUFACTURING COMPANY

ESTABLISHED 1880

1515 Sedgwick St., Dept. H, Chicago 10, Illinois, U.S.A.
Manufacturers of Scientific Instruments and Laboratory Apparatus

for Results

McGraw-Hill Mailing Lists Will Help You

- Merchandise your advertising
- Conduct surveys
- Get inquiries and leads for your salesmen
- Pin-point geographical or functional groups
- Sell direct
- Build up weak territories
- Aid dealer relations

Direct Mail is a necessary supplement to a well rounded Business Paper advertising program.

Most progressive companies allocate a portion of their ad budgets to this second medium at the same time as they concentrate on the best business publications.

600,000 of the top buying influences in the fields covered by the McGraw-Hill publications make up our 150 mailing lists. Pick YOUR prospects out of our Industrial Direct Mail catalogue.

Write for your free copy of our Industrial Direct Mail catalogue. With complete information.

TRANSIT CASES

FOR
ELECTRONIC EQUIPMENT

MIL SPECS
OR
COMMERCIAL REQUIREMENTS

USING
SANDWICH MATERIAL
AND
MOLDED FIBERGLAS

— ● —
PRODUCTS

- Arctic Shelters
- Reflector Panels
- Weather Shields
- Specialized Products

CUSTOM DESIGNED AND MANUFACTURED

GUARANTEED →

Skycyone Inc
PORT JERVIS, NEW YORK

GET THE FACTS

LOW and constant contact drop
 LOW electrical noise
 HIGH current density
 LONG life...



HIGH PERFORMANCE



BRUSHES CONTACTS SLIP RINGS

& Slip Ring Assemblies

BRUSH HOLDERS, CONTACT ASSEMBLIES,
 BRUSH ASSEMBLIES



USED EXTENSIVELY IN:

**SERVO • GUN-FIRE CONTROLS
 TELEMETERING • ROTATING
 THERMOCOUP and STRAIN
 GAGE CIRCUITS • ROTATING
 JOINTS • DYNAMOTORS**

Wide range of grades available for standard and special applications. Call on our 40 years of design experience to help solve your problems.

OTHER GRAPHALLOY

PRODUCTS: Unique (oil-free) self-lubricating Bushings and Bearings (applicable -450° to +700°F.; with expansion coefficient half that of steel will not seize shaft at low temperature); Oil-free Piston Rings, Seal Rings, Thrust and Friction Washers, Pump Vanes.



GRAPHITE METALLIZING CORPORATION

1055 Nepperhan Ave. • YONKERS, NEW YORK

- Please send data on Graphalloy BRUSHES and CONTACTS.
 Send data on BUSHINGS.

NAME & TITLE _____
 COMPANY _____
 STREET _____
 CITY _____ ZONE _____ STATE _____

Want more information? Use post card on last page.

NEW BOOKS

(continued)

physicists as well as to electronics engineers the basic information necessary to become intelligently acquainted with the problems of semiconductors. In addition, it is an excellent source book for those in the fields of inorganic chemistry, crystallography, experimental physics and others where the problems of semiconductors might arise.

The book is worthy of the highest recommendation. — E. KEONJIAN, *General Electric Co., Syracuse, N. Y.*

Thumbnail Reviews

Proceedings of the Symposium on Printed Circuits, Sponsored by RETMA and IRE—PGPT. Engineering Publishers, New York, 1955, 122 p, \$5 (paper). Presents twenty-five papers delivered at a symposium held in Philadelphia during January 1955. Subjects covered include product design, reliability, management considerations, production techniques and printed components used with printed wiring.

A Guide To Special Purchase Tubes. Graham Electronics Supply, Inc., Indianapolis, Indiana, 1955, 60 p, \$4.50 (paper). Cross reference data useful as a guide in searching for proper special purpose and industrial tube substitutions. Each listing gives manufacturers and other designations for the given tube.

The ARRL Antenna Book. Headquarters Staff, American Radio Relay League, West Hartford, Connecticut, 1955, 344 p, \$2 (paper). Contains information on antenna theory, design and construction. Subjects include fundamental transmission lines, long-wire antennas, multielement directive arrays, uhf and vhf systems, supports, receiving antennas, rotary beams and mobile antennas.

Transistor Applications. Raytheon Manufacturing Company, Newton, Massachusetts, 1955, 126 p, \$50 (paper). Describes constructional details on over fifty types of transistorized equipment as well as technical data on CK721, CK722, CK727 and other Raytheon transistors.

Convegno Di Elettronica e Televisione. Consiglio Nazionale Delle Ricerche, Rome, Italy, 1955, two volumes, 1,214 p. \$16.10 (paper). Contains 77 papers delivered during the Science Days—fourth session symposium on electronics and television held in Milan, Italy during April 1954. Papers are printed in the language in which they were delivered. Includes English, Italian, French and German. Subjects covered include trends in television

ZOPHAR

---WAXES
 ---COMPOUNDS

Zophar Waxes, resins and compounds to impregnate, dip, seal, embed, or pot electronic and electrical equipment or components of all types; radio, television, etc. Cold flows from 100°F. to 285°F. Special waxes non-cracking at 76°F. plain or fungicidal. Let us help you with your engineering problems.

For immediate service contact:

L. E. Mayer, Sales Manager
 A. Saunders, Technical Director
 H. Saunders, Chemical Laboratory

Phone 50uth 8-0907



ZOPHAR MILLS, INC.
 112-130 26th Street,
 Brooklyn 32, N. Y.

Over 85% of the torque wrenches used in industry are

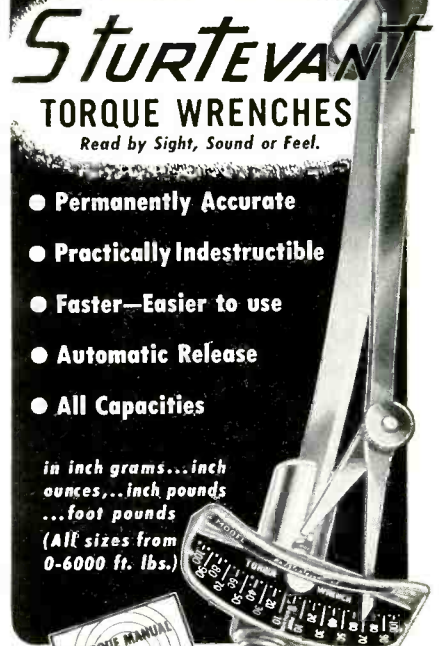

STURTEVANT
TORQUE WRENCHES
Read by Sight, Sound or Feel.

- Permanently Accurate
- Practically Indestructible
- Faster—Easier to use
- Automatic Release
- All Capacities

in inch grams...inch ounces...inch pounds...foot pounds (All sizes from 0-6000 ft. lbs.)



Every manufacturer, design and production man should have this valuable data. Sent upon request.

PA **STURTEVANT CO**
 ADDISON QUALITY ILLINOIS

Want more information? Use post card on last page.

Aerohm

Precision wire-wound Potentiometers



"Lo-TORK" POT LT 7/8

For minimum-torque uses in computer, servo, and selsyn service. Stainless-steel precision ball bearings. Maximum torque is 0.01 inch-ounce. Dissipates one watt at 80°C. Resistances—100 to 100,000 ohms. Weight is only 1/2 ounce. Ganging to six decks; internal clamps hold 7/8" diameter. Standard linearity 0.5%; on special order 0.25%; toroidal winding allows winding angles to 360°; standard 354°.

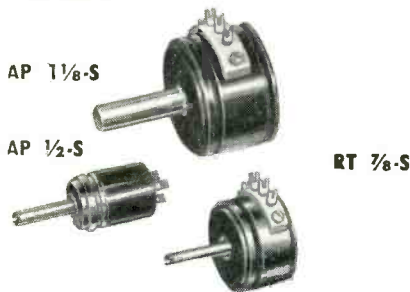

MICRO-MINIATURE and MINIATURE

Series AP 1/2-S—2 watts continuous at 80°C; resistances 10 to 20,000 ohms, 5% tolerance standard; diameter 1/2", depth 5/8", weight 1/4 ounce; sealed well enough for potting.

Series RT 7/8-S—3 watts continuous at 80°C; resistances 10 to 100,000 ohms; diameter 7/8", depth 3/8", weight 1/2 oz.; standard linearity 2%.

Series AP 1 1/8-S—4 watts continuous at 80°C; resistances 10 to 150,000 ohms; diameter 1 1/8", depth 1/2", wt. less than 3/4 oz.; standard linearity 1%.

All precision-machined, with anodized aluminum bodies, line-reamed phosphor bronze bearings, centerless-ground stainless steel shafts, and gold-plated fork terminals. Fully sealed and fungus-proofed. Can be processed, on special order for use at 125°C. Aerohm potentiometers are individually checked for quality and performance.



Write for copy
of our new
catalog.

WATERS MANUFACTURING, Inc.
Waltham 54, Massachusetts

APPLICATION ENGINEERING OFFICES IN PRINCIPAL CITIES

Want more information? Use post card on last page.
ELECTRONICS — November, 1955

NEW BOOKS

(continued)

developments, television equipment, broadcasting systems planning, international magnetic and dielectric material, transistors, electron optics, radar, industrial electronics, servo mechanisms and computers.

Techniques For Application of Electron Tubes and Military Equipment. Rex A. Whitlock. Wright Air Development Center, 1955, 100 p, available from Office of Technical Services, Washington, D. C., \$2.50 (paper). Presented from point of view of equipment designer as a guide in application of electron tubes. Book discusses tube properties, circuit design and specific tube types, including the 5654, 6AK5W, 5670 and 5751.

Digital Differential Analyzers—Part I—The Elements. George F. Forbes. George F. Forbes Publisher, Pacoima, California, 1955, 48 p, \$7.50 (paper). Intended to aid the mathematician and engineer in utilizing a digital differential analyzer in his work. The book tells how to code engineering problems in machine language and describes the operation and limitations of machines.

The Elements of the Theory of Real Functions. J. E. Littlewood. Dover Publications, Inc., New York, 1955, 71 p, \$2.85 (cloth), \$1.35 (paper). First American edition of a British book based upon lectures delivered by the author at Cambridge University.

F-M Limiters and Detectors. Alexander Schure. John F. Rider, Publisher, Inc., New York, 1955, 48 p. \$9.00 (paper). Fundamental theory and circuit design of f-m limiters and detectors including the 6BN6 gated-beam circuit.

Radio Interference Suppression Techniques. Coles Signal Laboratories. Available from Office of Technical Services, Washington, D. C., 256 p, \$6.75 (paper). Several sources are discussed including rotating machinery, ignition systems, switches, contactors and electronic devices. Other subjects include measurements of testing procedures, theory of interference suppression, suppression components and applications.

Light Calculations and Measurements. H. A. E. Keitz. N. V. Philips' Gloeilampenfabrieken, Eindhoven, Holland, 413 p, \$7.50. Written primarily from the viewpoint of the illumination engineer, this book contains material on electronic light measuring instruments and background information of potential interest to television engineers.

Handbuch der mikrochemischen Methoden. Zweiter Band—Verwendung der Radioaktivitaet in der Mikrochemie. By Friedrich Heet and Michael K. Zacherl. Springer-Verlag, Vienna, 1954, 423 p, \$19.30. Second section of book, 179 pages, discusses radioactivity measurements and electronic equipment used therein.

DC-AC CHOPPERS

0-500 cycles
DEPENDABLE



All military specifications met. Liberal factors of safety to meet emergency conditions.

1. Production sampled daily and life tested to check 1,000 hour rating.
2. Every Chopper given not only one but two tests over the full range of military temperatures before shipment.
3. Only gold contacts used for superior operation in the vital 0-1 1/2 volt d-c range.
4. Liberal safety factors to meet emergency conditions.
 - a. 0-500 cps.
 - b. Input voltage $\pm 30\%$.

WRITE FOR THESE
CATALOGS:
No. 371, 0-500 CPS.
No. 370, 60 CPS.

**STEVENS
ARNOLD
INCORPORATED**

22 ELKINS STREET
SOUTH BOSTON 27, MASS.

S/A-11

Want more information? Use post card on last page.

WIND UNIFORM TOROIDS WITH THE BOESCH AUTOMATIC COIL-WINDING MACHINE

By eliminating repeated manual functions the BOESCH Automatic Model TW-200-A provides the means of producing uniform coils without depending on the constant attention and skill of the operator.

Winds coils .218" I.D. to 5" O.D. #20 to #42 wire, with standard equipment. For this and other BOESCH machines, write for detailed information . . . *we can cut your labor costs.*

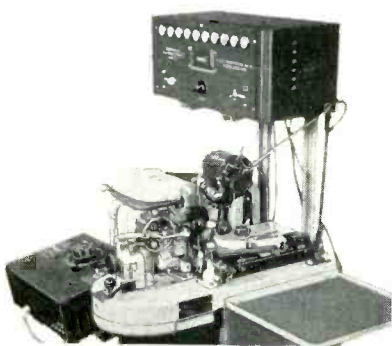

Model TW-200-A

Now — no licensing, no royalties required in the sale and use of BOESCH Machines



Want more information? Use post card on last page.

Backtalk

All-Magnetic A-F Amplifier

DEAR SIRS:

CONCERNING the errors appearing in Fig. 6 on page 125 of the September issue of *ELECTRONICS*, the circuit diagram shown was apparently redrawn by your artist.

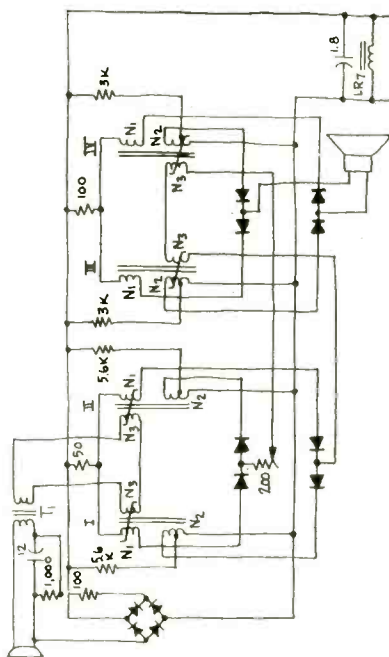

In the circuit as it was printed one set of rectifiers in each bridge has been reversed. This would make the circuit inoperable.

In addition, the winding notations as published in Fig. 6 do not agree with those in Table II to which it refers. The result of this is that the power winding and control winding values have been interchanged.

Corrections on the accompanying diagram conform to values published in Table II. If N_5 in the published diagram were made 10 turns as is indicated, instead of 130, our engineers are of the opinion that the set would burn up, destroying all the components.

These corrections have been made and noted on the diagram and the value placed on the capacitor in the frequency multiplier next to LR7, which was omitted in the published circuit.

MARY T. KANAGY
Technical Information Officer
By direction of the Commander
U. S. Naval Ordnance Laboratory
Silver Spring, Maryland

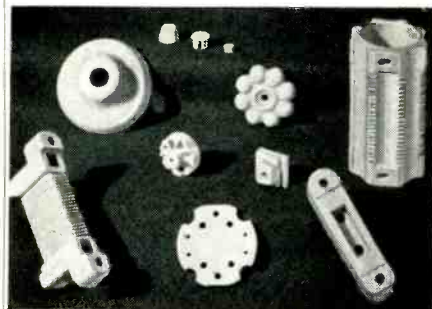

here's the answer
to a better product!

Meet Star VITROLAIN, a really versatile electrical porcelain. This basic material is a feldspathic type ceramic having superior dielectric and mechanical strength. Its pore volume and moisture absorption factors are extremely low (less than 0.25%). It is ideal for parts used in the presence of moisture and chemical vapors. Available in white and color glazes. Our 26-page catalog contains complete data. Write.

Star Porcelain Company
42 Muirhead Ave., Trenton 9, New Jersey

STAR
porcelain company

Ideal for
ANTENNA CONNECTIONS
PHOTO-CELL WORK
MICROPHONE CONNECTIONS

JONES SHIELDED TYPE PLUGS & SOCKETS

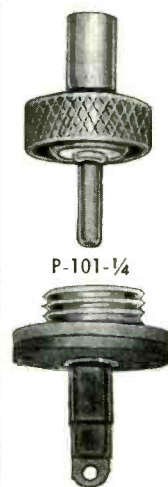

P-101-1/4

S-101

LOW LOSS PLUGS AND SOCKETS FOR HIGH FREQUENCY CONNECTIONS. SUPPLIED IN 1 AND 2 CONTACT TYPES:

101 Series can be furnished with 1/4", .290", 5/16", 3/8" or 1/2" ferrule or cable entrance. Knurled nut securely fastens unit together. Plugs have ceramic insulation and sockets have bakelite. Quality construction. Fine finish. Assembly meets Navy specifications.

For full details and engineering data ask for Jones Catalog No. CS-20

**JONES MEANS
Proven QUALITY**

Jones
HOWARD B. JONES DIVISION
CHICAGO MANUFACTURING CORPORATION
CHICAGO 24, ILLINOIS
SUBSIDIARY OF UNITED-CARR FASTENER CORP.

Want more information? Use post card on last page.

November, 1955 — *ELECTRONICS*

McGraw-Hill Mailing List Will Help You

- Merchandise your advertising
- Conduct Surveys
- Get leads for your salesmen
- Get inquiries about your product or service
- Pin-point geographical or functional groups
- Sell Direct
- Build up weak territories
- Aid Dealer Relations

Direct Mail is a necessary supplement to a well rounded Business Paper advertising program.

600,000 actual names of the top buying influences in all the fields covered by the McGraw-Hill publications make up our 150 mailing lists. These lists are built and maintained primarily for our own use, but they are available to you for Direct Mail purposes. Pick out a list of YOUR prospects from our Industrial Direct Mail Catalogue.

More and more, progressive companies are using Industrial Direct Mail regularly as an advertising medium. They effectively allocate a portion of their ad budgets to this second medium at the same time as they concentrate on the best business publications.

For complete, detailed information about our service, fill in the coupon or write for your copy of our free Business and Industrial Direct Mail catalogue.

for Results



Mc GRAW-HILL
DIRECT MAIL LIST SERVICE

Direct Mail Division

McGraw-Hill Publishing Co., Inc.
330 West 42nd St., N. Y. 36, N. Y.

Please forward my free copy of the
McGraw-Hill "Industrial Direct Mail Catalogue."

NAME _____

COMPANY _____

ADDRESS _____

CITY _____ STATE _____

CONTACTS

FOR THE FIELD OF ELECTRONICS



SAUERISEN CEMENTS
for FASTER ASSEMBLY ON
Radio Tubes

Leading electrical manufacturers use Sauerisen Cements for assembling, sealing and insulating.
Send unassembled parts or sketch for technical advice.

Write for Catalog

Sauerisen Cement Company · Pittsburgh 15, Pa.

\$175 f.o.b.
SHORTED TURN INDICATOR
FOR UNMOUNTED COILS
SENSITIVE, RUGGED, NON-SHOCKING



Kartron LEhigh 9-4606
Huntington Beach, Calif.

MICA
India • Brazil
BLOCKS • FILMS • SPLITTINGS
All Grades & Qualities — Warehouse Stocks New York — Prompt Forward Shipments

Phone: WOrth 4-4192 or write:
Associated Commodity Corporation
Woolworth Bldg., New York 7, N. Y.

ETCHED CIRCUITS
24 HOUR SERVICE
On
SAMPLES, MODELS & PROTOTYPES
SILK SCREENS MADE TO ORDER

ROWE ENGRAVERS
492 E. 39 St. Paterson 4, N. J.

This CONTACTS Section
supplements other advertising in this issue with these additional announcements of products essential to efficient and economical production and maintenance. Make a habit of checking this page, each issue.

MANUFACTURER'S REPRESENTATIVES

As a service to readers, ELECTRONICS presents the advertisements for some of the leading manufacturer's representatives in the electronics industry. These firms are qualified to help the Manufacturer with his distribution problems; the Buyer with his product needs.

S. BOSWORTH & CO.
Engineering Sales Representatives
PRECISION ELECTRONIC INSTRUMENTATION
COMPUTERS—CONTROLS

Industrials—Aircraft—Government—Universities
In Metropolitan New York and Adjoining Areas
214 Old Country Road, Hicksville, L. I., New York
Hicksville 4-2232

SAMUEL K. MACDONALD, INC.
manufacturers representatives over 25 years
1531 SPRUCE STREET, PHILA. 2, PA.

Territory: Pennsylvania • New Jersey
Delaware • Maryland
Virginia • West Virginia
District of Columbia

Other Offices:
Pittsburgh
Baltimore
Washington, D.C.

ART CERF & CO. *Manufacturers' Representatives*

LEADING ELECTRONIC LINES
Regular Coverage • 10 Men
6 States and District of Columbia

Phone: Mitchell 2-6734
744 Broad St.
NEWARK 2, N. J.



"OUR FOURTH YEAR"
The NEWHOPE CORPORATION
Lee Locke, Associate
A Sales Organization for the
RADIO, TV and ELECTRONIC INDUSTRIES
Four salesmen concentrating in Metropolitan New York City and New Jersey—in a 50-mile radius

Telephone: LEExington 2-7372
6 East 39th Street
New York 16, New York

PAUL HAYDEN Associates

ENGINEERING

Calling on JOBBERS
INDUSTRIALS
AUDIO SPECIALISTS

P. O. Box 331, EAST POINT, GA.
Telephone (Atlanta) - FAirfax 9646
BRANCH OFFICES AT
Burlington, N. C. • Birmingham, Ala. • Mt. Dora, Fla.

WAREHOUSING



NEW ENGLAND REPRESENTATION
To the electronics, electro-mechanical and instrument industries. Experienced electro-mechanical engineer provides competent and thorough engineering and sales coverage of New England States. Seeks major line, salary or commission basis.

Box 192, Cheshire, Conn.

McGRAW-HILL
TECHNICAL
WRITING SERVICE
AND



ATOMS FOR PEACE

FOR THE GENEVA CONFERENCE . . .

. . . the McGraw-Hill Technical Writing Service assisted in producing the U.S. information package presented to each delegate.

TWS designed, translated and produced "Atoms for Peace," a deluxe, full-color, four-language book describing the volumes of technical data.

TWS edited and illustrated the technical data for "Research Reactors" and "Chemical Processing and Equipment."

TWS prepared supporting booklets and display material in four languages.

FOR YOU . . .

. . . our staff will do literature research or prepare manuals, handbooks or such material as you require on nuclear energy or other technical subjects.

TECHNICAL WRITING SERVICE
McGraw-Hill Book Co., Inc.
330 W. 42nd St., N. Y. 36, N. Y.



PROFESSIONAL SERVICES

Consulting—Patents—Design—Development—Measurement

in

Radio, Audio, Industrial Electronic Appliances

AIRPAX PRODUCTS CO.

Development Division
Specialists in the
Design and Manufacture of
UNUSUAL TRANSFORMERS AND RELAYS
Middle River Baltimore 20, Ind.

CONSULT THESE SPECIALISTS:

Let them save your time by
bringing their broad experi-
ence in their specialty to
bear on your problems.

PICKARD & BURNS, INC.

Consulting Electronic Engineers
Analysis and Evaluation
of Radio Systems
Research, Development and Production
of Special Electronic Equipment
210 Highland Ave. Needham 94, Mass.

ANALYSIS INSTRUMENT CO.

Consultants on Magnetic Problems
Magnetic Materials Tested
Special Magnetic Devices Designed
Magnetizing & Testing Equipment Supplied
P. O. Box 7 Pequannock, New Jersey

ELECTRONIC RESEARCH ASSOCIATES, INC.

"TRANSISTORIZE" YOUR PRODUCT!
Complete Service in consulting, research, develop-
ment, and production on Transistor circuitry, prod-
ucts and instrumentation.
67 East Centre Street Nutley, N. J.
NUTley 2-5110

ALBERT PREISMAN

Consulting Engineer
Television, Pulse Techniques, Video
Amplifiers, Phasing Networks,
Industrial Appliances
Affiliated with
MANAGEMENT TRAINING ASSOCIATES
3224 - 16th St., N. Y. Washington 10, D. C.

H. O. BIXBY ASSOCIATES

Consultants to the Electronic Industry
SURVEYS — PROMOTIONS — LIAISON
PERSONNEL PLACEMENT — TECHNOLOGY
235 Main St. Cambridge 42, Mass.
ELiot 4-9404

ERCO RADIO LABORATORIES, INC.

Radio Communications Equipment
Engineering - Design - Development - Production
Our 27th Year in Air to Ground
Communications and Radio Beacons
Garden City • Long Island • New York

KARL F. ROSS

Registered Patent Agent
(U. S. and Canada)
Specializing in electronic patent matters
305 Broadway, New York 7, N. Y. WOrth 2-3419

THOMAS H. BRIGGS & ASSOCIATES

Electronics Consultants
Electron Tubes - Automation - Project Surveys
Tube Materials & Reliability - Servo-mechanisms
Engineering and production facilities.
Box 135 RD #2 Norristown, Penn. Tel. No. 8-7671

HANSON-GORRILL-BRIAN INC.

Product & Mfg. Development
ELECTRICAL - ELECTRONIC
HYDRAULIC - MECHANICAL
One Continental Hill Glen Cove, N. Y.
Glen Cove 4-7300

THE TECHNICAL MATERIAL CORPORATION

Communications Consultants
Systems Engineering
General Offices and Laboratory
700 Penimore Rd., Mamaroneck, N. Y.

CROSBY LABORATORIES, INC.

Murray G. Crosby & Staff
Radio - Electronics
Research Development & Manufacturing
Communication, FM & TV
Robbing Lane, Hicksville, N. Y.
Hicksville 3-3191

THE KULJIAN CORPORATION

ELECTRONICS DIVISION
Consulting Electronic Engineers
Research, Development, Production of
Automatic Controls — Special Instrumentation
1200 No. Broad St., Philadelphia 21, Pa.
Stevenson 2-9000

TELECHROME, INC.

Electronic Design Specialists
COLOR TELEVISION EQUIPMENT
Flying Spot Scanners, Color Synthesizers, Keyers,
Monitors, Oscilloscopes and Related Apparatus
J. R. Popkin-Churman, Pres. & Ch. Engr.
88 Merriek Rd. Amityville, L. I., N. Y.

DELAWARE PRODUCTS CO

Analog Voltage to Digital Conversion
Digital Voltage Recording Systems
Design-Development-Manufacturing
360 Broadway Camden 3, N. J.

Measurements Corporation

Research & Manufacturing Engineers
HARRY W. HOOK MARTIAL A. HONNELL
JOHN M. VAN BREDEN
Specialists in the Design and
Development of Electronic Test Instruments
Boonton, New Jersey

WALSH ENGINEERING CO.

Design and Prototypes
of Electronic Apparatus
in which Transformers and Magnetic Components
are especially important factors in Performance,
Size, Weight and/or Cost
34 DeHart Place Elizabeth, N. J.
Elizabeth 2-7600

EDGERTON, GERMESHAUSEN & GRIER, INC.

Consulting Engineers
Stroboscopy — Transient Oscillography
Photoelectricity — Pulse Techniques — Timing
High-Speed and Electronic Flash Photography
Telemetry - Industrial Television Applications
160 Brookline Avenue Boston 13, Mass.

NEW ROCHELLE TOOL CORP.

FOR CERTIFICATION OF INDUCTION
AND DIELECTRIC HEATING EQUIPMENT
IN ACCORDANCE WITH F. C. C. REGULATIONS
Mobile Test Unit Available Entire U. S.
320 Main St. New Rochelle, New York
Phone NE 2-3555

WHEELER LABORATORIES, INC.

Radio and Electronics
Consulting — Research — Development
R-F Circuits — Lines — Antennas
Microwave Components — Test Equipment
Harold A. Wheeler and Engineering Staff
Great Neck, N. Y. HUNter 2-7876

Eldico of New York, Inc.

Pioneers of Television Interference Elimination from
Transmitters, Induction Heaters, Diathermy and etc.
Donald J. S. Merten & Engineering Staff
72 E. Second St. Mineola, L. I., N. Y.
Pioneer 6-5212

NIAGARA ELECTRON LABORATORIES

CONSULTATION - DESIGN - CONSTRUCTION
MFG. THE THERMOCAP RELAY
Specializing in solution of problems of electronic
and electro-physical instrumentation for the research
or analytical laboratory. Industrial plant problems
also invited.
Andover, New York Cable Address: NIATRONLAB

YARDNEY LABORATORIES

Research-Design-Development
Electro-Chemical Generators of Energy
10-46 Leonard Street Worth 6-3100
New York 13, N. Y.

Note to Electronic and Mechanical Engineers

CHOOSING A COMPANY TO WORK FOR NOT AN EASY TASK

By Eugene F. Grant, Director of Engineering for National Company

Whether you are an engineer, baker, or lawyer, your real goals in life are similar . . . you want a challenging job; one that you know is worthwhile to yourself and the community. You want the chance to advance in your field just as fast as your abilities will allow. You want to work for a company that is respected by all and that gives full value for services rendered. All this in pleasant surroundings!



National Company meets all these requirements and in addition is particularly inviting because its growth prospects are excellent. Our size enables us to treat each engineer as an individual. You are not a payroll number but a person with ideas, hopes, thoughts, and a future. Your superiors are friendly and easily accessible; your co-workers are congenial.

FASCINATING WORK . . .

Today's engineer isn't satisfied with a job unless it presents a challenge. He wants to work on advanced products and to have the backing of an organization capable of putting his ideas to use. In this respect, suffice it to say that National has been a leader in the field since 1914. The surface has only been scratched on the applications of electronics to the future of communications.

We think you'll like National's location . . . just outside Boston. Take your choice of town or country living and enjoy New England all year 'round.

Of course, you want to know about salary and advancement. The latter is directly and completely up to you. You won't be held back by red tape or company restrictions. Your salary will be in line with what you would expect from a company which considers its engineers an investment in the future . . . an investment worthy of a generous outlay.

DO YOU QUALIFY?

We feel that your best chance of success with National comes after you have had 3 years' outside experience. We expect that you have a B.S. in E.E. We particularly would like to talk to project and senior engineers (both electronic and mechanical) with experience in designing communications systems, receivers, transmitters, pulse devices, microwave components, audio devices, and related equipment.

If you feel that National Company is the type of organization you'd like to look into further, send your résumé today to Mr. JOHN A. BIGELOW, Director of Industrial Relations.



NATIONAL COMPANY, INC.
58 Sherman St. Malden, Mass.

SEMICONDUCTOR DEVELOPMENT

DEVICE ENGINEERS

PRODUCTION ENGINEERS

APPLICATION ENGINEERS

SALES ENGINEERS



Responsible positions are now available with one of the leading and fastest growing semiconductor manufacturers. These are outstanding opportunities for Physicists and Engineers in research, development, or production of advanced germanium and silicon diodes and transistors. Experience in semiconductors or other components such as tubes or capacitors is desirable. Replies held in strict confidence. Send resume or call

Transitron electronic corporation

407 MAIN STREET, MELROSE, MASS.

MELROSE 4-9600

ELECTRONIC ENGINEERS

\$10,000 TO \$18,000

NO FEES

Outstanding company in the East, a leader in the electronic industry has several key openings at the project level or above.

They are working on guided missiles, air-borne radar, analogue computers, etc.

You owe it to yourself to investigate these opportunities on a confidential basis at no obligation to you.

Send three copies of your resume to:

HARRY L. BRISK,
(Member I.R.E.)

DEPARTMENT B

ACCREDITED PERSONNEL SERVICE

12 South 12th Street,
Philadelphia 7, Pa.

DRAKE PERSONNEL

National Placement Center for
**EXECUTIVE AND
TECHNICAL PERSONNEL**

General and Plant Managers
Plant Superintendents—Foremen
Accounting—Staff Personnel
Engineers: Design—Production
Sales Managers—Engineers

Please outline briefly your
experience or personnel needs to:

John Cope
220 S. State St., Chicago 4, Ill.
Harrison 7-8600

REPLIES (Box No.): Address to office nearest you
NEW YORK: 330 W. 42nd St. (36)
CHICAGO: 520 N. Michigan Ave. (11)
SAN FRANCISCO: 68 Post St. (4)

POSITIONS VACANT

Faculty Position, teaching, research (Solid State Physics) salary, rank, dependent upon qualifications. Graduate Assistantships (Teaching, research, or combination—Solid State Physics) leading toward MS. Out-of-State tuition waived. \$1600-1800 for 12 months. Z. V. Harvalik, Physics Dept., University of Arkansas, Fayetteville, Ark.

Physicist, Physical Chemist for applied research on semiconductors with a large research institution located Western Pennsylvania. Experience preferred but not essential. Give complete details regarding education, experience, and salary requirements in first letter. P-7790, Electronics.

Rapidly expanding Houston geophysical instrument manufacturer needs experienced electronics production superintendent. Desire man capable of securing maximum efficiency and economy in small quantity electronically precise instrument assembly. Modern air-conditioned factory. Salary \$8,000.00 to \$10,000.00. Send complete resume of personal history, education and experience to: General Manager, Technical Instrument Company, P. O. Box 6055, Houston 6, Texas.

SALES ENGINEER

Electronic engineer with successful record in sales of electronics systems. (Income \$15,000) seeks association for greater potential.

PW-8015, Electronics
330 W. 42nd St., New York 36, N. Y.

PROJECT ENGINEERS
ELECTRONICS & ELECTRO-MECHANICAL
\$600 - \$900 MO. NO FEE

Qualified men in fields of Radar, Missiles, Instrumentation, Radio-TV-Audio-Circuitry for research, design & development. We handle all details efficiently & confidentially upon receipt of resume of your background.

Contact—J. J. COOPER
O'SHEA EMPLOYMENT SYSTEM
"America's Largest"
64 E. Jackson, Chgo, Ill. Tel. WAbash 2-1884

PROJECT ENGINEER

Brilliant opportunity for young engineer with minimum two years experience in circuitry and packaging of electronic assembly. Rapidly expanding division of multiple plant manufacturer. Assured early promotion to administrative level. Will reward outstanding performance. Starting salary \$9000-\$11,000. Company pays all expenses.
28 E. Jackson Blvd. WAbash 2-9400 Chicago, Ill.
MONARCH PERSONNEL

100—PHYSICISTS—100

\$400 To \$1000 Mo
Any degree—Any experience. Unlimited future. Employer pays agency fee.

CONTACT BOB POOR
O'SHEA EMPLOYMENT SYSTEM
"America's Largest"
64 E. Jackson, Chgo, Ill. Tel WAbash 2-1884

OVER 600

EXPERIENCED ENGINEERS AND SCIENTISTS*

CHOSE RCA SYSTEMS, DESIGN OR DEVELOPMENT

CAREERS IN THE LAST YEAR!

*Plus hundreds of service, recent graduates and other engineers.



- SYSTEMS ENGINEERING
- COMPUTERS
- GUIDED MISSILE ELECTRONICS
- AVIATION ELECTRONICS
- ELECTRON TUBES

FIELDS OF ENGINEERING ACTIVITY	TYPE OF DEGREE AND YEARS OF EXPERIENCE PREFERRED											
	Electrical Engineers			Mechanical Engineers			Physical Science			Chemistry Ceramics Glass Technology Metallurgy		
	1-2	2-3	4+	1-2	2-3	4+	1-2	2-3	4+	1-2	2-3	4+
SYSTEMS <i>(Integration of theory, equipments and environment to create and optimize major electronic concepts.)</i>												
AIRBORNE FIRE CONTROL			W M			M				W M		
DIGITAL DATA HANDLING DEVICES			C			C				C		
MISSILE AND RADAR			M X			M				M		
INERTIAL NAVIGATION			M			M				M		
COMMUNICATIONS			C I							C I		
DESIGN • DEVELOPMENT												
KINESCOPIES (B & W and COLOR), OSCILLOSCOPES —Electron Optics—Instrumental Analysis—Solid States (Phosphors, High Temperature Phenomena, Photosensitive Materials and Glass to Metal Sealing)	L	L	L	L	L	L	L	L	L	L	L	L
RECEIVING TUBES —Tube Design—Test and Application Engineering—Chemical and Physical Development—Methods and Process Engineering—Advanced Development	H	H	H		H	H		H	H		H	H
SEMI-CONDUCTORS —Transistors—Semi-Conductor Devices—Materials	H	H	H				H	H	H			
MICROWAVE TUBES —Tube Development and Manufacture (Traveling Wave—Backward Wave)		H	H		H	H		H	H		H	H
GAS, POWER AND PHOTO TUBES —Photosensitive Devices—Glass to Metal Sealing	L	L	L	L	L	L	L	L	L	L	L	L
AVIATION ELECTRONICS —Radar—Computers—Servo Mechanisms—Shock and Vibration—Circuitry—Remote Control—Heat Transfer—Sub-Miniaturization—Automatic Flight—Design for Automation—Transistorization	M C X	M C X	M C X	M C	M C X	M C X	M C X	M C X	M C X	M C X		
COMPUTERS —Systems—Advanced Development—Circuitry—Assembly Design—Mechanisms—Programming	C	C X	M C X	C	C X	M C X	C	C X	M C X			
RADAR —Circuitry—Antenna Design—Servo Systems—Gear Trains—Intricate Mechanisms—Fire Control	M C X	M C X	M C X	M C X	M C X	M C X	M C X	M C X	M C X	M C X		
COMMUNICATIONS —Microwave—Aviation—Specialized Military Systems	C	C	C		C	C		C	C			
RADIO SYSTEMS —HF-VHF—Microwave—Propagation Analysis—Telephone, Telegraph Terminal Equipment		I	I		I	I		I	I			
MISSILE GUIDANCE —Systems Planning and Design—Radar—Fire Control—Shock Problems—Servo Mechanisms	M	M	M	M	M	M	M	M	M			
COMPONENTS —Transformers—Coils—TV Deflection Yokes (Color or Monochrome)—Resistors	C	Z C	Z C	C	Z C	Z C	C	C	C		Z	Z
MACHINE DESIGN Mechanical and Electrical—Automatic or Semi-Automatic Machines		L	L		L H	C L H		L	L			

Location Code: C—Camden, N.J. H—Harrison, N.J. I—International Div. L—Lancaster, Pa. M—Moorestown, N.J. W—Waltham, Mass. X—Los Angeles, Calif. Z—Findlay, Ohio

Modern benefits program . . . Liberal relocation assistance.

Please send resume of education and experience, with location preferred, to:

Mr. John R. Weld, Employment Manager
Dept. A-15L Radio Corporation of America
30 Rockefeller Plaza, New York 20, N. Y.



RADIO CORPORATION of AMERICA

Copyright 1955 Radio Corporation of America



needs

ELECTRONIC

and

MECHANICAL

ENGINEERS

in

SOUTHERN

CALIFORNIA

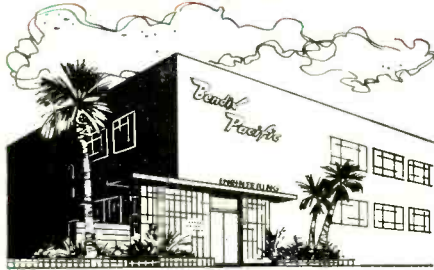

Unusual engineering positions in electrical and mechanical design of radar, sonar and telemetering are available. These positions, which are directly associated with our long-range projects for industry and for defense, are available at all levels.

Now nearing completion at Bendix-Pacific is the new Engineering Center. With more than 100,000 square feet of area it represents the latest and one of the most complete engineering facilities in the nation.

You are invited to consider becoming a member of this vital engineering group — with a forward looking company in Southern California.

Please fill in the coupon or write us for complete information.

W. C. Walker, Engineering Employment Manager
Pacific Division, Bendix Aviation Corp.
11600 Sherman Way, North Hollywood, Calif.

Please send information.

I am a graduate engineer with _____ degree.

I am not a graduate engineer but have _____ years experience.

Name _____

Address _____

City _____ Zone _____ State _____

RAYTHEON'S MISSILE and RADAR DIVISION



Bedford
Mass.

CAREER ENGINEERING POSITIONS

• **SENIOR RADAR SYSTEMS ENGINEER**

Attractive opening for engineer capable of advanced systems engineering for airborne radars. Strong background in electronic circuit design required. Experience in radar systems design and allied fields desirable. Long term developments involve application of interesting new techniques.

• **SENIOR SPECIFICATIONS ENGINEER**

5 or more years of experience in electronic design, application or technical writing required. Familiarity with military specifications desirable.

• **CIRCUIT DESIGN ENGINEERS**

Two to Three years electronics circuit design experience required. Must be capable of independent design and analysis and of supervising junior designers. Servo-experience desirable.

RAYTHEON'S MISSILE AND RADAR DIVISION is a well-established, progressive organization located 20 miles from Boston in an area offering excellent housing, recreational and educational facilities.

Please write, or apply in person, giving full particulars concerning education, experience, and salary to Mr. Gerald O'Neil, Staff assistant, the office of Division Manager.

RAYTHEON MANUFACTURING COMPANY

190 Willow Street, Waltham, Mass.

Stability and Opportunity for
ELECTRONIC ENGINEERS
who want more room to grow

Top opportunities for achievement and recognition are open at FTL... key unit of the world-wide, American-owned IT&T System. FTL's long-range development program offers stability and security. Finest facilities — plus broad and generous employee benefits.

INTERESTING ASSIGNMENTS IN:

- Radio Communication Systems • Electron Tubes
- Microwave Components • Electronic Countermeasures
- Air Navigation Systems • Missile Guidance
- Transistors and other Semiconductor Devices
- Rectifiers • Computers • Antennas
- Telephone and Wire Transmission Systems



**SEND RESUME TO:
PERSONNEL MANAGER,
BOX EL-11**

Federal Telecommunication Laboratories

A Division of INTERNATIONAL
TELEPHONE AND TELEGRAPH CORPORATION
500 Washington Avenue, Nutley, N. J.

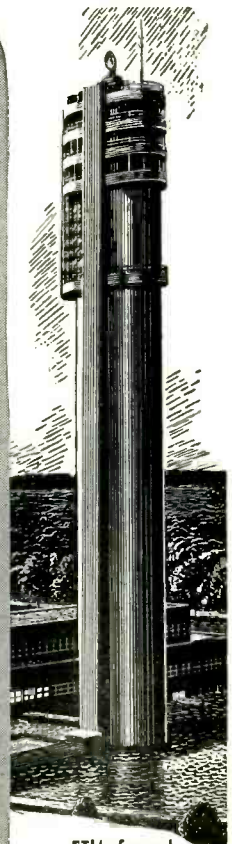

FTL's famed
Microwave Tower
— 28 minutes
From N. Y. C.

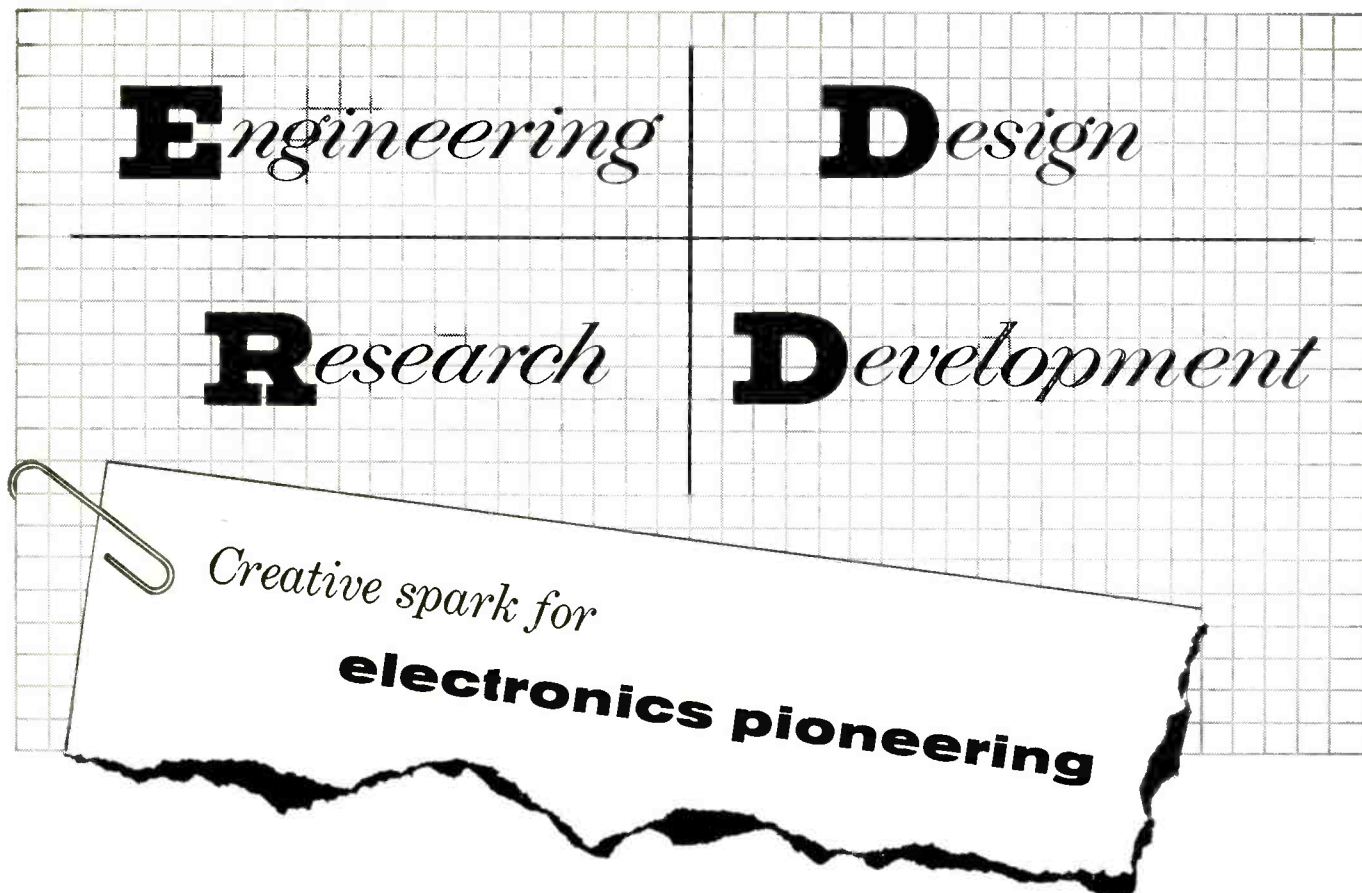

Here the creative skills of electrical engineers can enjoy what is literally a "field day."

For the fields in which such experts will be assigned at Goodyear Aircraft are as challenging as they are varied.

These include rewarding work on missile guidance, servo analysis and design, expansion and further evolution of the Goodyear-built analog computing equipment, antenna design, radar, electromechanical systems, microwave, pulse techniques, electrical systems and power plant design.

Here is an opportunity to establish a long and fruitful relationship with a versatile and stable organization—to utilize one of the largest and most modern computer laboratories, explore new avenues, new concepts—*a place where creative sparks can be charged to arc brilliant new horizons!*

Resumé treated confidentially. Application forms on request: C. G. Jones, Personnel Department, Goodyear Aircraft Corporation, Akron 15, Ohio. Plants in Akron and Litchfield Park, Arizona.

They're doing big things at

GOOD YEAR AIRCRAFT

THE TEAM TO TEAM WITH in AERONAUTICS

ENGINEERS

— HERE'S THE COMPLETE STORY

CROSLLEY

A recognized name in the field of Electronics. For more than a decade the carefully planned growth of the Crosley Government Products Division has been making Cincinnati the Electronics Center of the Midwest. Crosley's immediate expansion program offers numerous opportunities in many fields. Present plans call for continued expansion during the next ten year period.

The Crosley Government Products Division is a member of the AVCO Manufacturing Corporation — a family of famous names including Crosley Broadcasting, Crosley Appliances and Electronics, Bendix Home Appliances, Lycoming, American Kitchens, New Idea Farm Equipment and Horn Manufacturing Company.

WHAT IS CROSLLEY DOING NOW?

Crosley's Engineering Staff has been engaged in the design and development of a selected diversity of electronics equipment; such as Radar, Sonar, Gunsights, Transmitters, and Receivers. During recent years Crosley has gone into new applications of electronics and is doing Research, Advanced Development and Product Engineering in Guided Missiles, Gyros, Magnetic Amplifiers, Servos, Computers, Radar, Infra-Red Radiation, Detection Nucleonics, Transistors and Human Engineering. In addition, Crosley is one of the largest producers of Fire Control and Air Navigational equipment. These programs enable Crosley to place engineers in positions which offer them responsibilities and challenging opportunities for unlimited growth.

OPPORTUNITIES FOR YOU

The people on Crosley's engineering staff have progressed because

Crosley has been successful in its many fields of activity. This success also creates the need, today, for new members in our organization. There are openings at all levels of education and experience for individuals with backgrounds in any of the following: Electronics, Electro-Mechanics, Mechanics, Physics, Mathematics, Optics, Technical Writing, Packaging or Illustrating. These opportunities are in existing groups as well as in new groups now being formed.

WHAT YOU CAN EXPECT

The Crosley Engineering organization is divided into small groups to give every employee individual consideration and the opportunity to secure the position for which he is best fitted. In evidence of Crosley's successful employee relations program, Engineering Personnel turnover is but a fraction of 1% per year. Crosley offers top salaries, substantial group insurance and retirement benefits, a subsidized education program and modern air conditioned work areas which boast the latest engineering equipment and facilities. Transportation expenses for you and your family and your household belongings will be paid by Crosley.

WHERE YOU WOULD LIVE

Greater Cincinnati is located on a sweep of the Ohio River and is surrounded with charming residential sections on the hills overlooking the city. Our many modern shopping centers are distributed throughout the Greater Cincinnati area providing convenient lower cost shopping for Cincinnati residents without the inconvenience of metropolitan traffic.

Our commuting time to Crosley's modern plant, located in suburban Evendale, averages twenty minutes.

NOW

You Have Crosley's Story . . . May We Have Yours?

Address your resume to:

Desk E-2, Director of Engineering Government Products



2630 GLENDALE-MILFORD ROAD CINCINNATI 15, OHIO

CORNELL AERONAUTICAL
LABORATORY, INC.
of Cornell University
is seeking

ELECTRONIC ENGINEERS

for positions in all levels of experience above Junior Engineer

Communications
Dynamic Control Systems
Aircraft Instrumentation
Radar
Computers
Electrical Measurements
Varied Electronic Circuits
Servo-Mechanisms
Missile Guidance
Microwave

If you have a B.S. degree and experience, imagination and potential, we invite you to communicate with our Employment Manager

Cornell Aeronautical Laboratory
BOX 235 BUFFALO 21, N. Y.

PROPOSAL and QUOTATIONS EXPERT for ELECTRONIC SYSTEMS

Must have Scientific Degree (preferably in Electronics) or heavy background in complex electronic systems. Minimum 5 years experience.

Must be able to work with our engineers to prepare commercial and government proposals for new electronic digital computers, communications and instrumentation systems.

Several positions open—East coast and Middle West.

Contract Administration Engineers
for our
RAPIDLY EXPANDING PROGRAMS
Electronic Digital Computers
Instrumentation
Communications

Qualified men who can work with our sales, engineering and manufacturing staffs to carry out general contracts administration work relative to our highly technical products. Prefer Scientific Degree (preferably in Electronics) and several years applicable experience.

Phone or write Dept.: N-15.

Remington Rand
Division of Sperry Rand Corporation
Engineering Research Associates Division
1902 W. Minnehaha Avenue
St. Paul W4, Minnesota
Midway 6-9601

BENDIX RADIO IS GROWING FAST!

...and has new, exceptional opportunities for:

ELECTRONIC ENG.
MECHANICAL ENG.
PHYSICISTS

RADAR FIELD ENG. TECHNICAL WRITERS

...to move ahead fast while working on:

COMPUTERS

RADAR
(Fixed, Airborne, Mobile)

AIRBORNE COMMUNICATIONS
& NAVIGATION EQUIP.

MISSILE GUIDANCE SYSTEMS

MOBILE COMMUNICATIONS

AUTO RADIO

MICROWAVE DEVELOPMENT

TRANSISTOR APPLICATIONS

Yes, we are expanding both our government and commercial business. This means you will step up your engineering career fast with us! You will work in our new, modern engineering building with the most modern equipment. You'll benefit from top salaries . . . a secure future . . . placement at highest level of your capabilities . . . pleasant living in beautiful residential area. Contact us right away! A postal card is all that's necessary. We guarantee speedy, confidential action on our part!

Address: Personnel Manager, Dept. J

Bendix Radio

DIVISION OF
BENDIX AVIATION
CORPORATION

Baltimore 4, Maryland

BENDIX RADIO IS

GROWING

FAST!



a new engineering building . . .



a leader in the electronics field . . .



a pioneer of advanced electronics!

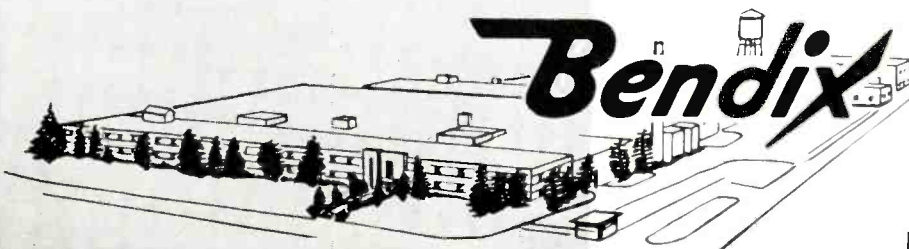

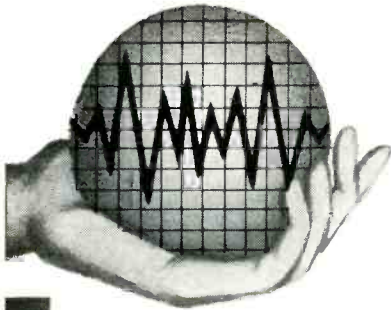

ENGINEERS

How Realistic Are You About Your Future In Electronics?

As the electronics industry grows from \$9 billion to \$20 billion in the next 10 years, will you be growing with it?

In answering, consider the extent to which your personal progress is dependent on the progress of the company you are with... and the following facts about Sylvania:

- Sylvania has expanded to 45 plants and 16 laboratories in 11 states
- In 6 years, the electronics industry grew 24%; Sylvania grew 32%
- Since 1949, Sylvania has doubled its engineering staff and tripled its sales

Sylvania's success story is the story of its creative engineers. These men of talent are given wide latitude to experiment... every facility to test original designs... and are rapidly advanced in the company as is shown by the fact that the average age of high level officials at Sylvania is only 45.

If you are realistic about your future, look into the opportunity now open to join Sylvania... and be high in your profession 10 years from now.

WALTHAM Engineering

Majors in E.E., M.E., Math, Physics. Research & Development experience in —

- Countermeasures
- Systems Analysis
- Transistor Applications
- Noise Studies
- Antenna Res. & Dev.
- Systems Development
- Mechanical Design
- Miniaturization
- Digital Computer
- Circuits & Systems
- Circuit Design
- Shock & Vibration
- Technical Writing
- Missile Analysis

Missile Systems Laboratory

- Radar Research & Development
- Missile Guidance & Ground
- Equipment Analysis
- Systems Evaluation Operations
- Research

BUFFALO Engineering

Majors in E.E., M.E., or Physics. Experience in Product Design and Advanced Development in —

- Circuit Design
- Systems Development
- Pulse Techniques
- F.M. Techniques
- Equipment Specifications
- Components
- Microwave Applications
- Servo Mechanisms
- Subminiaturization
- Mechanical Design
- Shock & Vibration
- Heat Transfer

INTERVIEW & RELOCATION EXPENSES WILL BE PAID BY SYLVANIA

Sylvania provides financial support for advanced education as well as liberal insurance, pension and medical programs.

Please forward resume to: Professional Placement Supervisor

SYLVANIA ELECTRIC PRODUCTS INC.

Thomas A. Tierney
100 First St.
Waltham, Mass.

Randall A. Kenyon
175 Great Arrow Ave.
Buffalo 7, N. Y.



Your inquiries will be answered within 2 weeks

WANTED:

Electronic and Mechanical Engineers at Bendix-Pacific

This is the new Engineering Center at Bendix-Pacific now nearing completion. With 100,000 square feet of area, it represents the latest and one of the most complete engineering facilities in the nation.

You are invited to consider becoming a member of this vital engineering group — with a forward looking company in Southern California.

Unusual engineering positions in electrical and mechanical design of radar, sonar and telemetering are available. These positions, which are directly associated with our long-range projects for industry and for defense, are available at all levels.

Please fill in the coupon or write us for complete information.



W. C. Walker, Engineering Employment Mgr.
Pacific Division, Bendix Aviation Corp.
11608 Sherman Way, North Hollywood, Calif.

Please send information.

I am a graduate engineer with _____ degree.
I am not a graduate engineer but have _____ years experience.

Name _____

Address _____

City _____ Zone _____ State _____

ENGINEERS PHYSICISTS

*If YOU have the
POTENTIAL for SUCCESS
Burroughs means
Business*

Seeking The Good Things Of Life?

If you are engaged in the serious, but highly interesting process of selecting a place to work . . . one which will give full reign to your many talents . . . one where management recognizes and rewards exceptional effort and creativeness . . . one which will produce high yields of personal satisfaction as well as the GOOD THINGS of LIFE for you and your family . . . then, be sure to select as your employer an established, vigorous and highly successful company which, by intelligent planning for ITS FUTURE is guaranteeing you the opportunity and security you are seeking!

For nearly 75 years, BURROUGHS has been a leading company in an expanding industry . . . the growing, highly diversified field of business equipment. As

proof of its forward look, the RESEARCH LABORATORY in Paoli, Pa., was established to create the Data Processing machines of tomorrow!

RECENT GRADUATES or EXPERIENCED MEN

. . . this is an invitation to BOTH of you to inquire about the employment opportunities this success story has made possible . . . to share in the valuable company benefits and cooperative educational aid which BURROUGHS is proud to offer qualified men at BOTH graduate and work-experience levels.

Present Openings

. . . are in the fields of Communications, Data Handling, Electronic, or Electro-Mechanical Business Machines . . . including such specifics as High Speed Mechanisms, Paper Handling Devices, Magnetic-Tape Transport Mechanisms, Magnetic-Drum or Tape Applications, Guided Missiles, Radar, Telemetering, Process Control Instrumentation, Digital and Analog Computers, Transistors and Magnetic Amplifiers, Servo Mechanisms and Electronic Packaging Design.

Electrical Engineers

. . . circuit designers to develop new circuit techniques and/or apply them to advanced systems development that will lead to product design.

Physicists

. . . solid state components, with application directed towards electronic devices for BOTH Government and commercial uses.

Mechanical Engineers

. . . mechanism and electronic packaging design and development to meet Government and commercial customer acceptance.

Logical Designers; Senior

. . . for system design involving interconnection of basic logical elements to effect arithmetical and logical function of data processing equipment.

Call or Write PLACEMENT MANAGER For Interview At YOUR Convenience

Burroughs

RESEARCH CENTER

Paoli, Pa.

A Philadelphia Suburb



SYLVANIA'S CALIFORNIA RESEARCH LABORATORY

(San Francisco Bay Area—Near Palo Alto)

Needs experienced creative engineers for a long range research and development program in microwave electronic systems and components. Also needs experts in design and custom packaging of specialized electronic communications equipment.

**We have specific openings for
ENGINEERING SPECIALISTS and SENIOR ENGINEERS in:**

SYSTEMS ANALYSIS For weapons systems planning, operational analysis and data handling problems.

MICROWAVE ANTENNAS For investigation of new concepts in polarization and pattern control, direction finding and multi-function radiators.

MICROWAVE CIRCUITS For advancements in synthesis of filters, broadband mixers, power dividers, etc., involving modern techniques of stripline, ridge guide and periodic structures.

TRANSMITTER DEVELOPMENT For research and development involving microwaves and pulse techniques.

FIELD ENGINEERING For advanced engineering field tests of prototype equipment.

COMMUNICATIONS SYSTEMS For design and development of complex communications systems.

Sylvania offers the finest facilities and equipment available. We also provide financial support for advanced education, as well as a liberal insurance, pension and medical program.

Our Laboratory is located 5 miles from Palo Alto in the San Francisco Bay area, close to excellent schools and universities, unexcelled living conditions, ideal climate and ample housing.

RELOCATION EXPENSES PAID

Please send complete resume to
JOHN C. RICHARDS
Electronic
Defense
Laboratory
Box 205
Mountain View,
California

ELECTRONIC DEFENSE LABORATORY

*All inquiries
will be answered
within two weeks.*

SYLVANIA
SYLVANIA ELECTRIC PRODUCTS INC.

Instrumentation System ENGINEER GUIDED MISSILES FIELD

Expansion in the guided missiles field has led to the creation of a new opening with a major company, located in upper New York State which offers real technical challenge to an instrumentation system engineer. The job involves: Establishing total instrumentation requirements; engineering systems to meet requirements and sub-dividing them to hardware units; establishing requirements on ground station equipment and environment standards for instrumentation equipment.

The engineer will be expected also to provide liaison with agencies providing ground stations. Approximately 10 years experience is desired.

An opening is also available to an engineer with a minimum of 5 years experience able to establish test plans and execute tests to prove hardware design, including installation and necessary service to test site.

BOTH JOBS CARRY ALL OF THE WELL KNOWN BENEFITS OFFERED BY THIS COMPANY INCLUDING EDUCATIONAL OPPORTUNITIES.

Send complete resume to
P-7986—Electronics
330 W. 42nd St., New York 36, N. Y.

ELECTRONIC ENGINEERS

For responsible positions in small, expanding advanced development laboratory. Excellent opportunity for advancement. Experience in the following fields is especially important:

- Television (Flying-spot Scanners)
- Pulse Circuitry
- Digital Coding Systems
- Radar Tracking Equipment
- Electro-mechanical Equipment

Please submit resume, including salary required.

P-7305, Electronics
330 W. 42nd St., New York 36, N. Y.

RECEIVER ENGINEERS TRANSISTOR CIRCUIT ENGINEERS SUBMINIATURE EQUIPMENT ENGINEERS

**Career Opportunities
With Well Established
Central Connecticut Firm**

**Challenging Projects
Top Salaries
Suburban Living**

Replies Held in Strict Confidence
Wire or Phone Collect
Personnel Mgr. SHERWOOD 7-2741

**THE ALLEN D. CARDWELL ELECTRONICS
PRODUCTIONS CORPORATION**
Plainville, Connecticut

If you qualify, here is the
KEY TO YOUR FUTURE

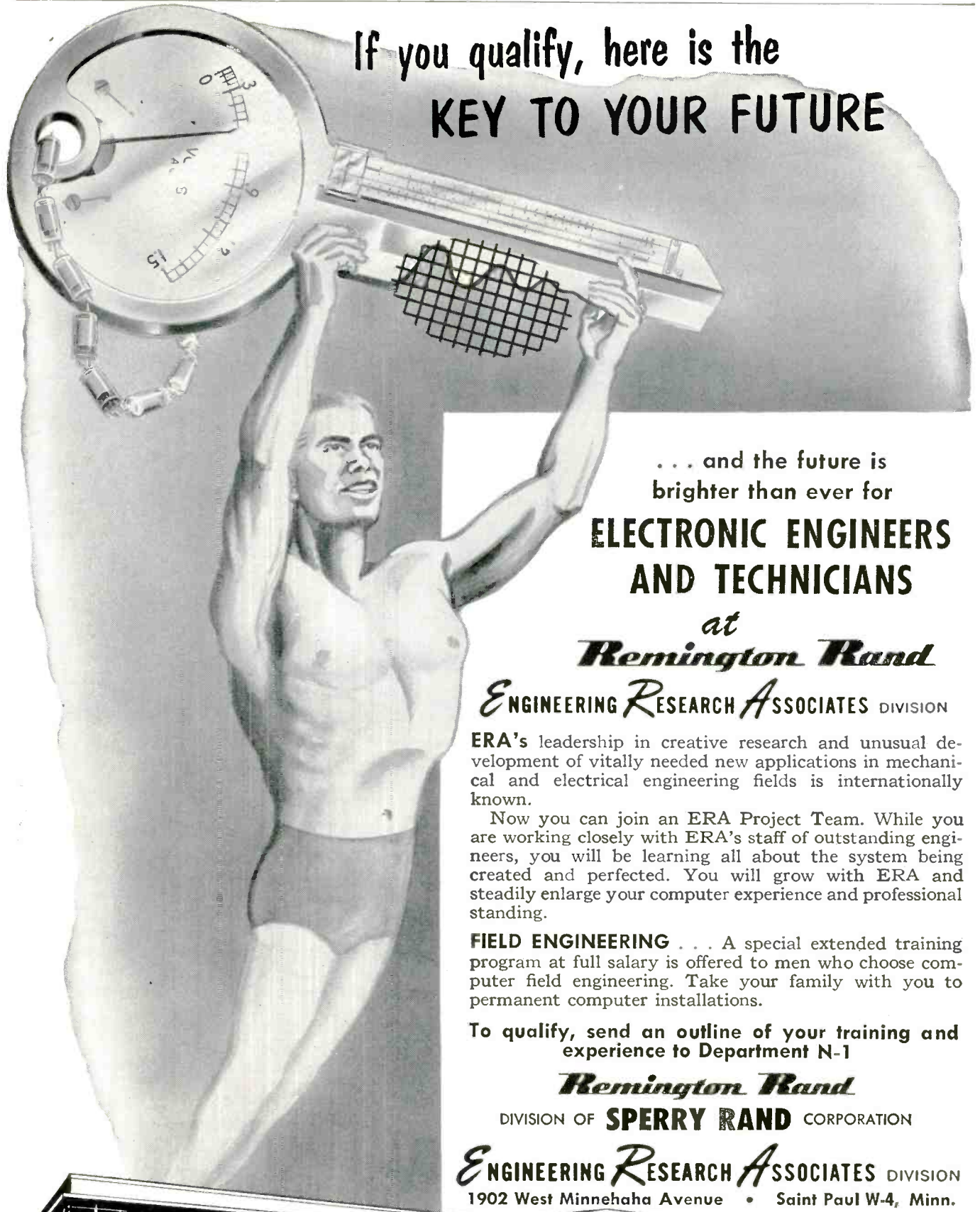

... and the future is
 brighter than ever for

**ELECTRONIC ENGINEERS
 AND TECHNICIANS**

at
Remington Rand

*E*NGINEERING *R*ESearch *A*SSOCIATES DIVISION

ERA's leadership in creative research and unusual development of vitally needed new applications in mechanical and electrical engineering fields is internationally known.

Now you can join an ERA Project Team. While you are working closely with ERA's staff of outstanding engineers, you will be learning all about the system being created and perfected. You will grow with ERA and steadily enlarge your computer experience and professional standing.

FIELD ENGINEERING . . . A special extended training program at full salary is offered to men who choose computer field engineering. Take your family with you to permanent computer installations.

To qualify, send an outline of your training and experience to Department N-1

Remington Rand

DIVISION OF **SPERRY RAND** CORPORATION

*E*NGINEERING *R*ESearch *A*SSOCIATES DIVISION

1902 West Minnehaha Avenue • Saint Paul W-4, Minn.

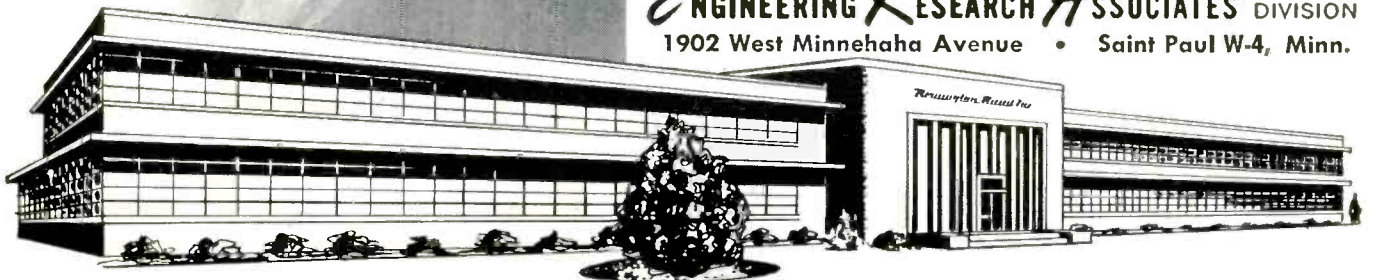

NORTH AMERICAN HAS BUILT MORE AIRPLANES THAN ANY OTHER COMPANY IN THE WORLD

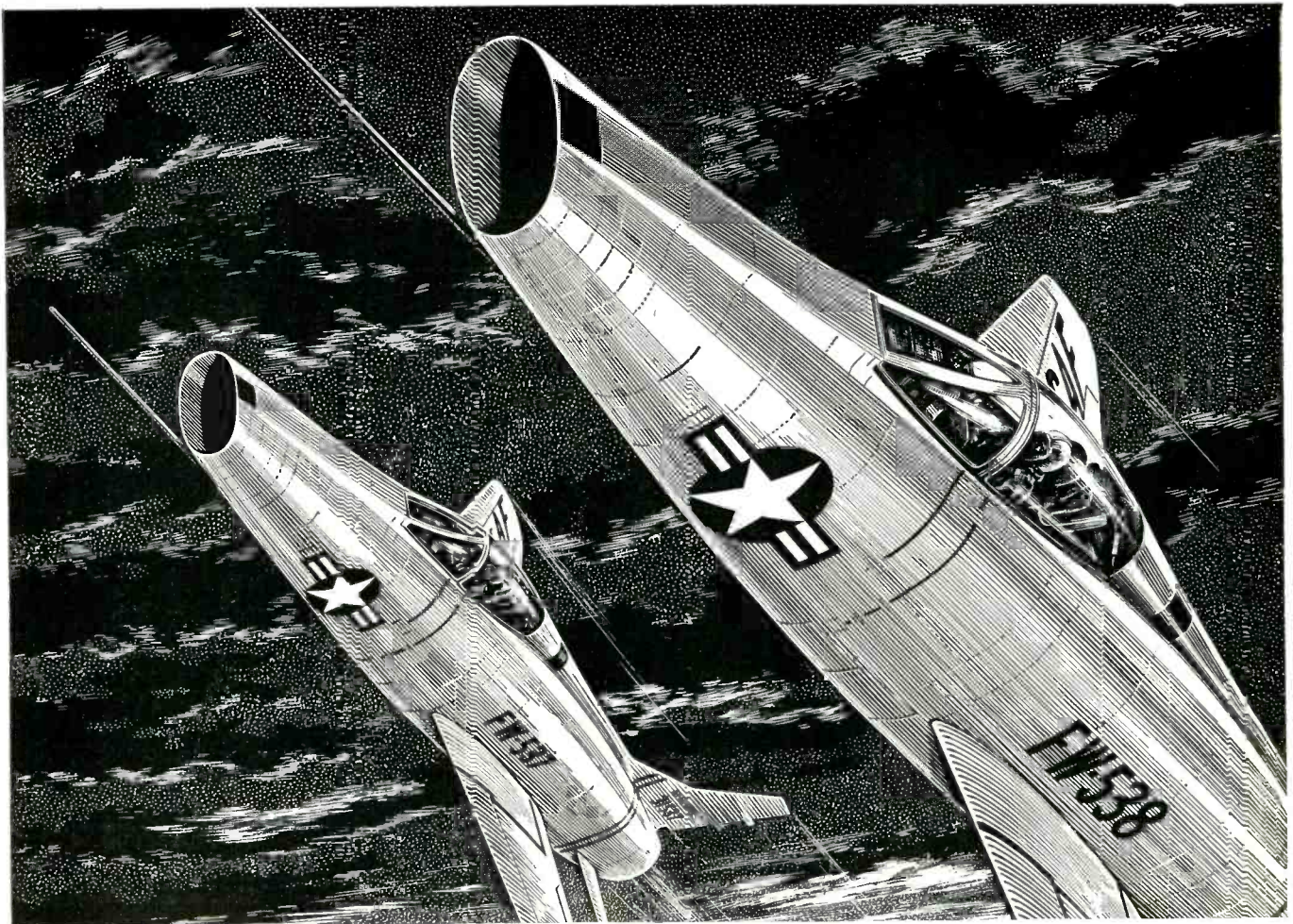

North American F-100 SUPER SABRE*, America's first operational, supersonic jet fighter.

NORTH AMERICAN ENGINEERING—LOS ANGELES—OFFERS CAREERS FOR ENGINEERS

North American Aviation's supersonic F-100 SUPER SABRE* is only the beginning . . . AIRBORNE VEHICLES of the FUTURE are *now* daily design problems for North American Aviation engineers. *You* start where our research has led.

Because North American is expanding, we can now offer challenging opportunities to engineers in most specialties, with rewards to match your experience.

You'll work with world-recognized top men . . . in a unique engineering organization in which you do your own liaison and coordination. You're on a team, working with everybody on the team. Your own ideas are welcomed and recognized — for example, our Patent and Suggestion Award plans are virtually unmatched in the industry. At North American, too, you enjoy a fine Retirement Plan and full personal benefits.

SPECIAL OPPORTUNITIES

ENGINEERING RESEARCH LABORATORY: New positions for all types of electrical and electronic engineers exist at all levels of experience in our Research Laboratory. These positions have been created by North American's leadership in research . . . you will take up where our research has led. You'll work closely with world-recognized engineers . . . on the team that's engineering ahead for a better tomorrow.

ENGINEER DESIGNERS: New positions available in structural and mechanical design. These positions involve design of highly intricate gun mechanisms, landing gears, hydraulic systems, thin

metal structural components, and fuel cell and power plant installations. Engineering degrees preferred, although some engineering college and practical experience in associated design fields will qualify.

ELECTRIC MOTOR DESIGN GROUP: A new group is now being formed to design specialized electric motors. This is an unusual challenge for men with fractional H.P. A.C. and/or D.C. motor design experience. You'll work with new metals, new ideas . . . you'll design the electrical motors needed for future aircraft designs.

WRITE TODAY:

Mr. L. Stevenson, Engineering Personnel Office, North American Aviation, Dept. 56-EL, L.A. 45, Calif.
ENGINEERING AHEAD FOR A BETTER TOMORROW



NORTH AMERICAN AVIATION, INC.

*TRADEMARK

Bendix OFFERS

3 SENIOR ENGINEERING JOBS

WELL WORTH LOOKING INTO...

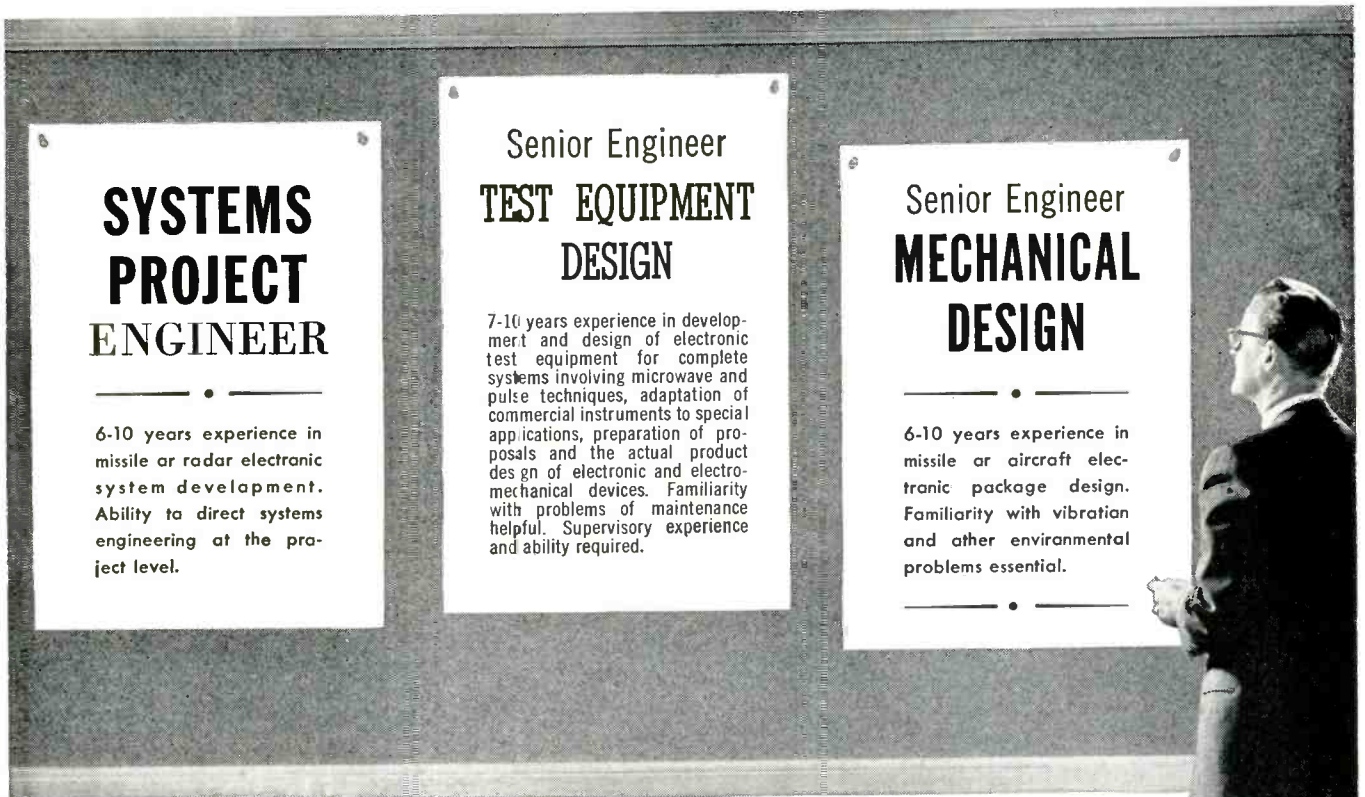

SYSTEMS PROJECT ENGINEER

6-10 years experience in missile or radar electronic system development. Ability to direct systems engineering at the project level.

Senior Engineer TEST EQUIPMENT DESIGN

7-10 years experience in development and design of electronic test equipment for complete systems involving microwave and pulse techniques, adaptation of commercial instruments to special applications, preparation of proposals and the actual product design of electronic and electro-mechanical devices. Familiarity with problems of maintenance helpful. Supervisory experience and ability required.

Senior Engineer MECHANICAL DESIGN

6-10 years experience in missile or aircraft electronic package design. Familiarity with vibration and other environmental problems essential.

Here are three especially attractive job opportunities for engineers who want to get on the ground floor in the important, interesting, and challenging phase of a new industry—guided missiles.

Qualified men are given real job responsibilities with Bendix and grow with the development of what is not only the nation's most important weapon system, but a project that will undoubtedly lead to new and im-

portant long-range commercial application.

At Bendix you will be associated with top missile authorities and have at your command unexcelled engineering and manufacturing facilities. Salaries for these top jobs and other opportunities are open for discussion. Write today to: Mr. W. L. Webb, General Manager, Missile Section, Bendix Products Division, Bendix Aviation Corporation, 401 North Bendix Drive, South Bend, Ind.

23 OTHER ENGINEERING POSITIONS!

Bendix also offers unusual job opportunities for assistant engineers, junior engineers, and technicians, as well as a score of other assignments. A 30-page book describing in

detail every phase of our guided missile operation will be sent to you on request. If you are interested in guided missiles, this book is bound to interest you. Write for it today.



UNIVAC

The FIRST Name
In Complete Electronic Computing Systems

Is Expanding Its Field Of Operations

New . . . Different . . . Exciting Uses for
Advanced Models of UNIVAC Are Already
Here . . . With Even MORE TO COME!

To Truly
Ambitious, Capable, Creative
ENGINEERS
Sperry Rand

OFFERS
OPPORTUNITIES UNLIMITED

If your educational or employment background
is such that you feel yourself qualified for the
following **ENGINEERING** and **ALLIED POSI-**
TIONS in the field of **ELECTRONICS**—

Mechanical Engineers

. . . M.E. Degree with experience
for advanced positions. Specific
assignments in the development
of computer packaging, case work,
input-output devices and servo
mechanisms.

Electrical Engineers

. . . E.E. Degree required. A wide
range of positions are open to
those experienced in such fields as
circuit design, pulse techniques,
input-output devices and magnetic
recording techniques.

Also

Many Other Challenging Openings For

- COMPUTER PROGRAMMERS
- MATHEMATICIANS
- PHYSICISTS
- PRODUCT ANALYSTS
- ENGINEERS JUNIOR & SENIOR

Company Benefits Include

. . . Graduate Study Opportunities with Complete Tuition Refund and
Valuable Retirement and Group Insurance Programs.

- For Appointment Telephone Baldwin 3-7300 •

Or Write D. A. BOWDOIN, Placement Manager

Remington Rand

ECKERT-MAUCHLY DIVISION

SPERRY RAND CORPORATION

2300 W. Allegheny Avenue

Philadelphia, Pa.



Executives and Engineers deserving higher salary

now can *completely, confidentially* make arrangements for better positions through our unique Job Improvement Service.

As publishers of Engineers' Job Directory we have close contact with leading manufacturing and research firms in all sections of the country.

Here's what you do. Send us your name, title, company and *home address*. We will forward to your home brief forms which you fill out and return. We compare your experience and desires with our file of specific job openings. You make the decision. No obligation to you, no cost whatsoever. Our clients pay us to find you. Find out what you're really worth—today. Write, phone or wire.



DECISION INC.

*Management and
Recruitment Consultants
Oliver P. Bardes, President
440 First National Bank Building
Cincinnati 2, Ohio*

electronic ENGINEERS

Excellent, long-range opportunities with a progressive company for top level men of established reputation and experience, and for junior engineers who are seeking an interesting future in design and development of klystrons, magnetrons, semi-conductors traveling wave tubes, TR and ATR tubes, RF microwave components . . . full benefits program.

Write to:

BOMAC

Laboratories

Beverly,

Massachusetts

CIRCUIT DESIGNERS

TEST
MANUFACTURING
TELEPHONE
ELECTRICAL

ENGINEERS

TOOL AND MECHANICAL
DESIGNERS



EXPERIENCED IN ELECTRO
MECHANICAL PRODUCTS, FOR
USE IN COMMUNICATIONS,
AUTOMATION, AIR-BORNE
CONTROLS

Due to extensive expansion program,
North has immediate openings for Engi-
neers & Technicians.

Opportunity to work with some of
the industry's finest Engineers.

Headquarters in Galion. Small town
living, yet close to large municipalities.

Send resume to A. V. Ryon-
Director of Personnel

NORTH ELECTRIC COMPANY

Galion Ohio

OPPORTUNITY

Research and Development Engineer

Experienced in the design and develop-
ment of resistance elements for the elec-
tronic industry. Excellent opportunity to
join forces with an aggressive organiza-
tion. An established medium size company
located in Cleveland, Ohio. State qualifi-
cation, salary desired, present status and
references.

P-7461, Electronics
330 W. 42nd St., New York 36, N. Y.

ENGINEERING OPPORTUNITIES

for you!

CONVAIR-Pomona is engaged in develop-
ment, engineering and production of elec-
tronic equipment and complex weapons
systems. The Convair-Pomona engineering
facility is one of the newest and best equip-
ped laboratories in the country. The work
in progress, backed by Convair's outstand-
ing record of achievement, offers excellent
opportunities for recent graduates and ex-
perienced engineers in the following fields:

- ELECTRONICS**
- DYNAMICS**
- AERODYNAMICS**
- THERMODYNAMICS**
- OPERATIONS RESEARCH**
- HYDRAULICS**
- MECHANICAL DESIGN**
- LABORATORY TEST ENGINEERING**

Generous travel allowance to engineers who
are accepted.

*For further information on Convair and its
fields of interest, write at once, enclosing a
complete resume to:
Employment Department 3-G

*ENGINEERING
BROCHURE
TO QUALIFIED
APPLICANTS

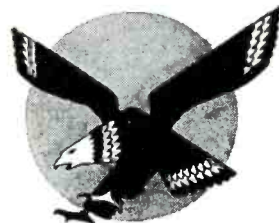

C O N V A I R

A DIVISION OF GENERAL DYNAMICS CORPORATION
POMONA, CALIFORNIA

GENERAL MOTORS



ENGINEERS DESIGNERS NEEDED!

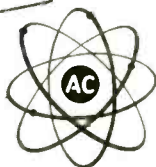

G.M. ELECTRONICS DIVISION offers challenging, pioneering opportunities to ambitious men. We extend a cordial invitation to every deserving Engineer and Designer to write us their wants. We may be able to supply the square hole for the square peg!

CREATIVE OPPORTUNITIES in the following fields: Missile Guidance Systems; Jet and Turbo Prop Engine Controls; Bombing and Navigational Computer Systems; Airborne Fire Control; U.H.F. Communications, MICROWAVE EQUIPMENT, etc.

YOUR FUTURE depends on your making the right connection with the right firm as quickly as possible. Why not send full facts about your education, work background, etc. We will do all we can for you and treat it with the fullest confidence.



**AC SPARK PLUG • THE ELECTRONICS DIVISION
GENERAL MOTORS CORPORATION
MILWAUKEE 2, WISCONSIN**

• • • for those who qualify

Security

Understanding

Know how

Send resume to



offers

ELECTRONIC ENGINE

- HEAVY BACKLOGS
- SOUND FINANCING
- TOP BENEFITS
- MANAGEMENT BY ENGINEERS
- EDUCATIONAL AID
- MINIMIZED RED-TAPE
- VARIED SPECIALIZATION
- FLEXIBLE ORGANIZATION
- VERSATILE PERSONNEL

R. F. LANDER

Electronic Engineering Company
of California



180 SOUTH ALVARADO STREET
LOS ANGELES - 57 - CALIFORNIA

ENGINEER

M. E. or E. E.

DIGITAL COMPUTER DEVELOPMENT

Excellent opportunity to join an expanding, stable company, with an outstanding position in the precision electronic control industry.

Opening now available for an engineer able to assume responsibility for the development of complete systems for fire control and guidance, or major portions of such systems. Work will include research and development in the field of complex analog or digital computers.

A degree in electrical or mechanical engineering is required or the equivalent in experience. Send resume in confidence to:

Technical Personnel Dept. 2-509

ARMA

Division American Bosch Arma Corp.
Roosevelt Field, Garden City
Long Island, N. Y.

ELECTRONIC ENGINEERS

Must have 2-5 yrs. exp. in the design of IF, VHF and/or UHF broad band systems. Progressive firm, many benefits.

Phone or write
MR. G. W. FELLENDORF
Instruments for Industry, Inc.
Mineola, N. Y. Pioneer 2-5300

TECHNICAL REPRESENTATIVES

LEAR, INC. is expanding its top notch Field Service organization to keep pace with increasingly wide-spread military acceptance of LEAR flight control systems and flight reference systems.

Attractive salary, liberal expense arrangements. Assignments may require travel or residence at assigned stations. Company orientation prior to assignment.

Qualifications include:

1. E. E. Degree of equivalent.
2. Knowledge of servomechanisms, gyros, electronics.
3. Tech. Rep. experience.
4. Must Be U. S. Citizen

To Apply, send resume to:
Field Service Manager



LEAR, INC.

110 Ionia Ave., N. W.
Grand Rapids 2, Mich.

ELECTRONIC ENGINEERS

Guided Missiles Test . . .

Join General Electric in a position created by expanding operations in the guided missiles field. Your assignment: developing pre-launch confidence testing, circuit design and component design of all sub-systems of a missile system.

To qualify you should have experience in the development and design of aircraft or missile system test equipment plus a B.S. in EE with Electronics Option. Salary is excellent and living conditions in this upper New York State location are attractive.

Please send resume to:
MR. JAMES HEVELIN
Special Defense Projects Dept.

GENERAL ELECTRIC

2900 Campbell Ave.
Schenectady, N. Y.

LOCATE IDEALLY

Growing concern located in large college town in Southwest needs engineers with one to four years' experience in electronics, servomechanisms, computers and data handling. Profit sharing possibilities.

DORSETT LABORATORIES
401 East Boyd Street
Norman, Oklahoma

CHALLENGING CAREERS AT RAYTHEON

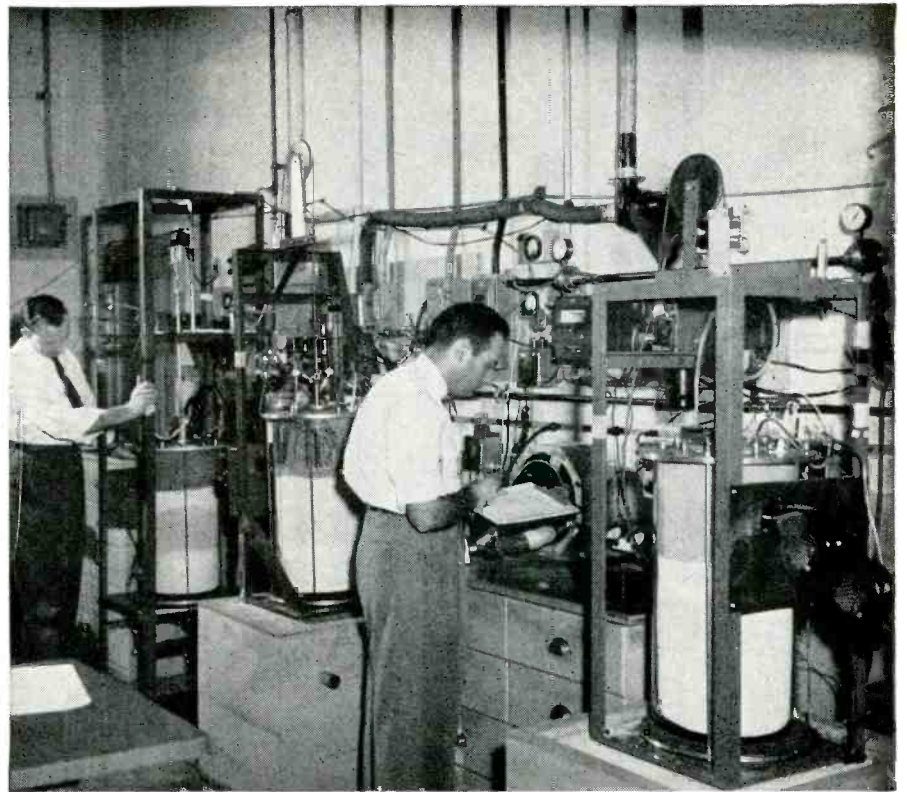

Checking on a process in one of Raytheon Research Division's "furnace" rooms. Single crystals of silicon (melting point near 1400°C) are grown in these furnaces.

Ready to move UP in electronics?

In Raytheon's extensive research program, a variety of special furnaces and equipment is used for the preparation, purification and study of semiconductor materials. This research is fundamental to the continuing pre-eminence of Raytheon in the field of transistors and diodes. Today there are more Raytheon transistors in use than all other makes combined.

When you join Raytheon you work in an atmosphere of progress. University graduate study is encouraged through a tuition refund plan. Openings now for engineers, scientists in many areas including:

microwave tubes • special purpose tubes • guided missiles transistors • diodes • receiving tubes • TV receivers • radar metallurgy • ceramics • communications • cathode ray tubes sonar • servomechanisms • solid state physics • field engineering

Join a team where performance pays off. Please address inquiries to L. B. Landall, Professional Personnel Section.



RAYTHEON MANUFACTURING COMPANY

190 Willow St., Waltham 54, Mass.

Plants also located in California and Illinois

What Opportunities in Electronics are on the Horizon at GENERAL ELECTRIC?



Huge antenna used with new radar height-finder needs a room all its own above the control center in the radome building erected in Arctic climates. Air pressure supports the rubberized glass fabric radome "balloon." Entrance to the radome is through an air lock chamber.

Advances in electronics are so rapid at General Electric that today's predictions appear tomorrow as equipment bearing the GE symbol.

The opportunities created by the scope and pace of the field are increased at General Electric by the facilities and range of professional advantages which GE engineers enjoy.

This means that GE electronics engineers have incentives, satisfactions and rewards that lead to accelerated personal development and advancement in the company.

ENGINEERS • PHYSICISTS

Positions available in the following fields:

Advanced Development, Design, Field Service and Technical Writing in connection with:

MILITARY RADIO & RADAR • MULTIFLEX MICROWAVE
MOBILE COMMUNICATION • SEMICONDUCTORS • ELECTRONIC COMPONENTS • TELEVISION, TUBES & ANTENNAS

Bachelor's or advanced degree in Electrical or Mechanical Engineering, physics, and experience in electronics industry necessary.

Please send resume to:
Dept. 11-5-E — Technical Personnel

GENERAL ELECTRIC

ELECTRONICS PARK, SYRACUSE, N. Y.

PERMANENT ASSIGNMENTS

IN THE FIELD OF MILITARY WEAPONS SYSTEMS

Missiles Reliability Studies
Fire Control Radar
Sonar
Underwater Ordnance

**systems
engineers**

**applied
physicists**

REAL CAREER OPPORTUNITIES

You'll enjoy the advantages of a small company atmosphere in the Silver Spring Laboratory . . . along with the stability of being part of the rapidly growing Vitro Corporation of America with 5 diversified operations throughout the United States

- Suburban Location in residential community adjacent to Washington, D. C.
- Plentiful housing — modern apartments, houses to rent or buy
- Advanced courses available at 4 major universities
- Cultural advantages of the nation's capitol

Vitro has similar opportunities also available at West Orange, N. J. laboratory and Eglin Air Force Base, Florida.

Write to Personnel Manager

VITRO LABORATORIES

962 WAYNE AVE.

SILVER SPRING, MD.



ELECTRONIC ENGINEERS!

-
- *Big opportunities*
- *await you at*
- *Bendix York!*
-

To the Engineer who is a recent college graduate, as well as to those with experience in all phases of advanced design, Bendix York offers opportunities outstanding in its field. As a young and expanding division, Bendix York provides fascinating and challenging assignments. Good salaries, all employee benefits, ideal living conditions in a beautiful suburban area are yours.

-
- Send resume of Education and Experience to: Mr. L. D. Smith, Employment Supervisor
-
-

Bendix

**AVIATION CORPORATION
YORK DIVISION**

Phone: York 5521 York, Penna.

quality control
SYSTEMS ENGINEERING
 component design
ENVIRONMENTAL ENGINEERING
 coordination
ADMINISTRATION
RESEARCH
 production engineering
 packaging
DEVELOPMENT

Regardless of which is your ultimate objective the broad practical experience you get in **FIELD ENGINEERING** will supplement your theoretical training, prepare you to meet the challenge of the future and put you years ahead!

RAYTHEON FIELD ENGINEERING

is diversified, Radar, Sonar, Guided Missiles, Computers, Microwave and other specialized equipments offer an outstanding opportunity to qualified men to earn excellent salaries while working among authorities in these fields. Your performance regulates your progress. Liberal insurance and retirement plans. Generous travel allowances and other benefits. Grow with a growing organization. Write now.

RAYTHEON MFG. CO.
 Government Service Department
 100 River Street
 Waltham 54, Massachusetts

Chief Engr.
CATHODE RAY TUBES

for expanding manufacturer of Cathode Ray tubes. Experienced in tube process and development including recent color; equipment design and development. Emphasis on research and mass production. Growth potential. Salary open. Send detailed resume.

P-7816, Electronics
 330 W. 42nd St., New York 36, N. Y.

**ENGINEER,
 ME or EE**

GYROSCOPICS

Research facilities that enable you to test out your most revolutionary ideas and encouragement to publish original work available to the engineer experienced in precision gyroscopic equipment.

Assignments in the field of missile guidance systems will include both mechanical and electrical problems involving lubrication, temperature control, bearings, vibration and shock mounts, development work in components such as pickups, accelerometers, amplifiers and computers, plus project work on complete gyroscopic systems.

ME, EE or equivalent experience required. Send resume in confidence to:

Technical Personnel Dept. 2-500

ARMA

Div. American Bosch Arma Corp.
 Roosevelt Field, Garden City
 Long Island, N. Y.

TO THE FINE ENGINEERING MIND
 SEEKING THE CHALLENGING PROJECTS IN

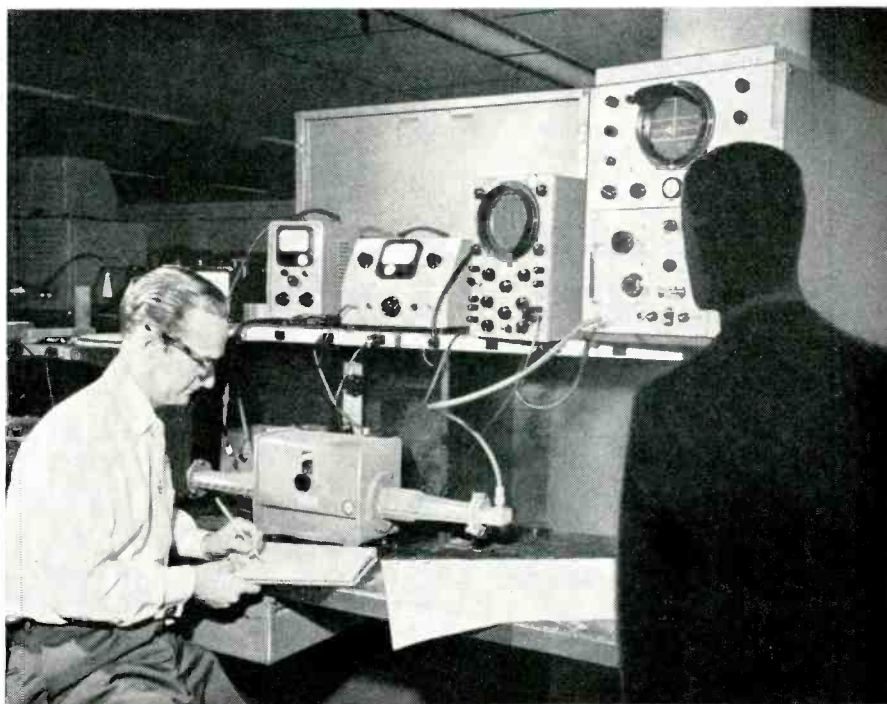

MICROWAVE ENGINEERING

Convair, in beautiful San Diego, now earnestly needs skilled **MICROWAVE ENGINEERS AND PHYSICISTS**: to solve design problems of an advanced nature in microwave antennas and scanners. Must be experienced in pencil beam and shaped beam designs for guided missile and airborne radar applications. For analytical and experimental work in the design of microwave components for specialized microwave radar systems and test equipment. For experimental development of components in the fields of dielectric and metallic media including familiarity with radome and microwave lens design. Unusual opportunities for senior level engineers with advanced degrees or equivalent experience.

At **CONVAIR** you will find an imaginative, explorative, energetic engineering department...truly the "engineer's" engineering department to challenge your mind, your skills, your abilities in solving the complex problems of vital, new, long-range programs. You will find salaries, facilities, engineering policies, educational opportunities and personal advantages excellent.

Generous travel allowances to engineers who are accepted.

Write at once enclosing full resume to:

H. T. Brooks, Engineering Personnel, Dept. 911

CONVAIR

A Division of General Dynamics Corporation

3302 PACIFIC HIGHWAY SAN DIEGO, CALIFORNIA

Lovely, sunny, **SMOG-FREE SAN DIEGO**, ever-growing area of three-fourths million people, offers you and your family a way of life judged by most as the Nation's finest for climate, natural beauty and easy (indoor-outdoor) living. Housing is plentiful and reasonable.

DEVELOPMENT ENGINEERS

PROJECT SENIOR INTERMEDIATE

- Antenna & Microwave Systems & Components
- Pulse & Radar Circuitry
- Telemetry Systems
- Communications
- Navigational Systems

TAKE A STEP TOWARD THE FUTURE WITH

the progressive and well established Maryland Electronic Manufacturing Company.

We've grown to now number more than 300 employees . . . steady growth, too, with never a layoff. Because MEMCO is an engineering-managed organization we feel that we offer an exceptional atmosphere for personal growth, with real opportunity for your recognition and advancement.

Here's what you will find at **MEMCO**

- Modern, complete and self-sufficient engineering and production facilities in suburban College Park, Md. 6 miles from Washington, D. C.
- Attractive salaries and profit sharing plan.
- Aid and encouragement in the presentation of technical papers plus the educational opportunities at 4 nearby universities.
- Suburban living with fine schools and housing plus the cultural advantages of the nation's capitol.
- A real challenge for imaginative and energetic engineering talent.

For interview please write Mr. J. E. Richardson

MARYLAND ELECTRONIC Manufacturing Company
5009 Calvert Road
College Park, Maryland

UNUSUAL CREATIVE FREEDOM at *Bendix* AVIATION RESEARCH LABORATORIES DIV.

• The center of advanced development activities for the Bendix Aviation Corporation offering excellent opportunities in design, research and development.

SYSTEMS ENGINEERS

To coordinate and supervise a group of engineers and mathematicians in systems analysis and design.

MATHEMATICIANS

Evaluation of servo control and guidance systems and components of a system. Analysis of systems and applications.

MACHINE DESIGNERS

Design of automatic machine tools, machine tool hydraulic servos, and digitally controlled tools.

CONTROLS ENGINEERS

Analyze and synthesize control system and design, develop and package such systems.

COMPUTER ENGINEERS

Development of special purpose digital and analog computers for process and business applications.

MICROWAVE SPECIALISTS

Research and development in advanced microwave techniques.

MECHANICAL ENGINEERS

Develop mechanical and hydraulic components for servo controls. Systems engineering and dynamic analysis of numerically controlled machine tools.

- Staff will participate in the initial exploration of new fields and the development of new commercial products.

All replies confidential—
send brief resume to:

DIRECTOR OF PERSONNEL
BENDIX AVIATION CORPORATION
RESEARCH LABORATORIES DIVISION
4855 Fourth Avenue • Detroit 1, Mich.

ENGINEERS • PHYSICISTS

Here's a **REAL Deal**

offered by the

Electronic Tube Division

of

Westinghouse

at ELMIRA, N. Y.

Send your resume TODAY to R. M. Jarrett

WESTINGHOUSE ELECTRIC CORP.
Electronic Tube Division • Elmira, N. Y.

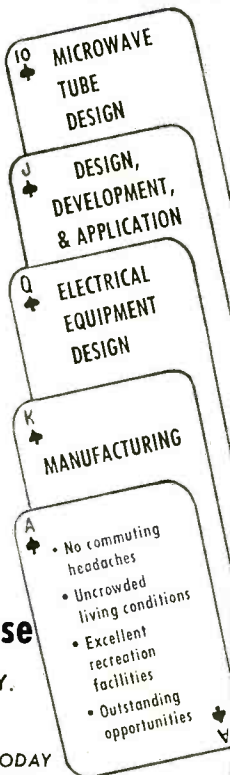

SENIOR ELECTRONICS ENGINEERS

EE degree or equivalent experience. Background in communications and navigation desirable. Permanent positions in design and development. Citizenship required. Position at Rochester, New York. Excellent living and recreational conditions in this area.

ADDRESS:

Chief Electronics Engineer
STROMBERG-CARLSON COMPANY
ROCHESTER 3, NEW YORK

ELECTRICAL ENGINEERS

To work on engineering problems in development of new Regulated AC and DC supplies, transistors, semi-conductor circuitry and magnetic amplifiers. BEE, or BS with physics or math major, plus some allied experience.

SORENSEN & COMPANY, INC.
375 Fairfield Avenue Stamford, Conn.

COOK RESEARCH LABORATORIES

THE FIELD OF RESEARCH OFFERS *Satisfying* CAREERS

We maintain one of the nation's most progressive research and development laboratories and are looking for qualified engineers — Senior and Junior — who are interested in furthering their careers in the field of research.

If you are interested in becoming part of a GROWING COMPANY — with OUTSTANDING PERSONNEL — at HIGH STARTING SALARIES — and EXCELLENT WORKING CONDITIONS contact

Mr. D. M. Halliday

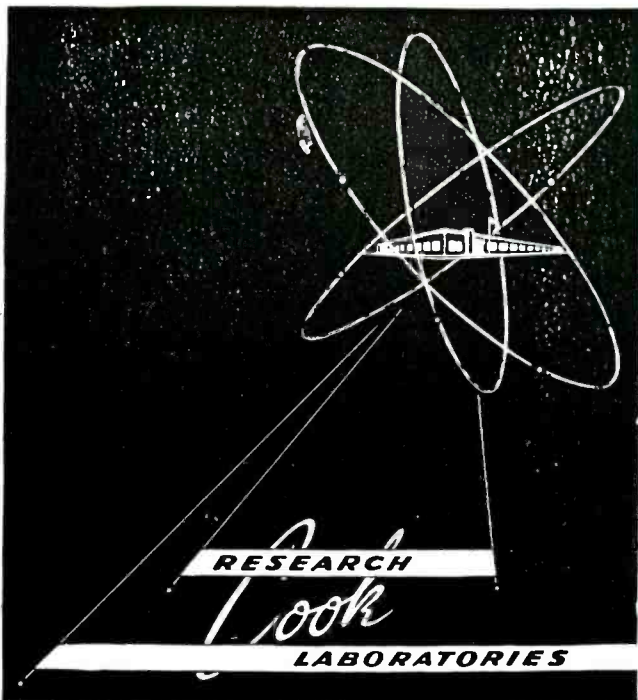

Immediate Openings in

- RADAR
- MICROWAVE TECHNIQUES
- FIELD THEORY
(Electro-Magnetic)
- SERVOMECHANISMS
- AERONAUTICAL ENGINEERING
- AERODYNAMICS
- THERMODYNAMICS
- AIRCRAFT INSTRUMENTATION

★ 8100 N. Monticello Ave.,
Skokie, Illinois KEystone 9-2060

★ A division of COOK ELECTRIC COMPANY
2700 N. Southport Ave., Chicago, Illinois

Electrical and Mechanical Engineering and Manufacturing Since 1897

ENGINEERS

The APPLIED PHYSICS LABORATORY of THE JOHNS HOPKINS UNIVERSITY offers an exceptional opportunity for professional advancement in a well-established Laboratory with a reputation for the encouragement of individual responsibility and self-direction.

Our program of

GUIDED MISSILE RESEARCH and DEVELOPMENT

provides such an opportunity for men qualified in:

Design and Analysis of Pulse Circuits
Research and Development in Radar and Microwaves

Electronic Packaging

Development of Telemetering, Data Processing, and Special Switching Equipment

Magnetic Amplifier Design & Analysis

Development and Application of Printed Circuits

Servomechanisms and Control-System Analysis

Please send your resume to
Professional Staff Appointments

APPLIED PHYSICS LABORATORY
THE JOHNS HOPKINS UNIVERSITY

8609 Georgia Avenue
Silver Spring, Maryland



ATTENTION COMMUNICATIONS ENGINEERS

Opportunities for Engineers in an expanding program of Communications Equipment development at Raytheon's new Equipment Engineering facility in Wayland, Massachusetts in the following classifications:

PROJECT ENGINEER

Supervise development of Microwave Communications Systems. Establish requirements and coordinate design of receivers, transmitters and multiplex equipment.

VIDEO CIRCUIT DESIGN

Wideband amplifiers for multiplex telephone, color television, timing and synchronizing circuits for vidicon camera units.

SYSTEM DESIGN

Analysis and design of wideband Microwave Communications Systems.

PRODUCT DESIGN

Responsibility for the packaging of Communications Equipment for production. Experience in case design, component layout, heat transfer, sheet metal techniques. Industrial design experience desirable.

Write to Edward W. Reed, Communications Engineering Department, 150 California Street, Newton, Massachusetts, to arrange for an interview and visit of our extensive laboratory facilities.

RAYTHEON MANUFACTURING COMPANY

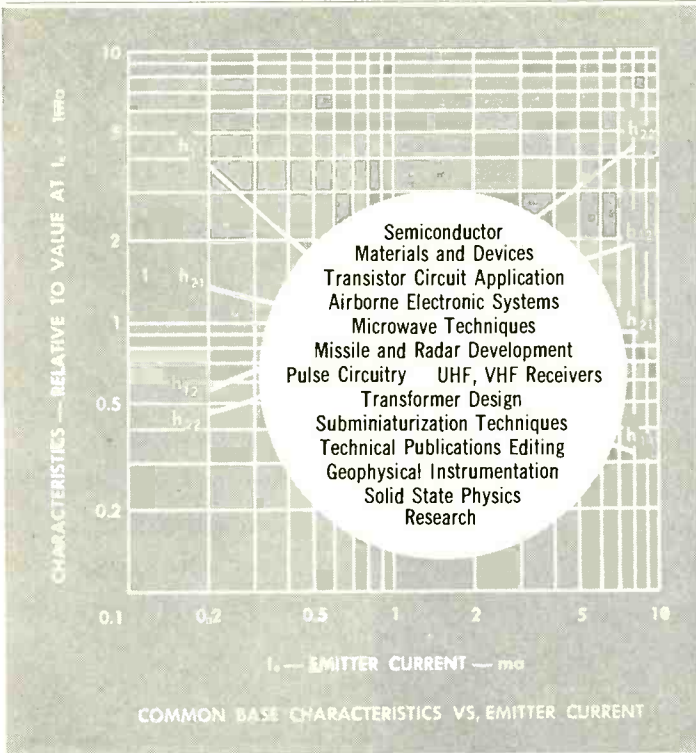

Choose your future at TI!

ENGINEERS / PHYSICISTS

TEXAS INSTRUMENTS offers exceptional career opportunities in its expanding research, development and design programs. These are permanent positions that offer excellent opportunities with a progressive, expanding company. If you have a B.S., M.S., or Ph.D. in Electrical or Mechanical Engineering or Physics you should investigate the interesting, challenging and rewarding research or development positions now open at TI.

At TI you will enjoy the long-range stability of a 25-year-old leader in the electronics industry and many employee benefits... profit sharing, insurance, retirement plans, etc.

For interview appointment phone or write our Personnel Director.



TEXAS INSTRUMENTS

INCORPORATED

6000 LEMMON AVENUE DALLAS 9, TEXAS

ELECTRONIC ENGINEERS

YOU CAN SHAPE THE FUTURE OF ELECTRONICS

with Sanders Associates, Inc.

Sanders Associates, Inc. offers to Electronic Engineers the opportunity to build careers in the electronic world of tomorrow by creative engineering today. Our goal is to shape the future of the industry—not to follow in the footsteps of others. The impact of Sanders on the electronics industry in four short years has been the result of engineering performance... with such "firsts" to our credit as PANAR, tri-scan antenna, and "tri-plate" microwave plumbing.

In guidance systems, weapons systems, countermeasures, in system concepts, basic circuitry, techniques, component development, microwave antenna, electro-mechanical transducers—in every phase of the art, both military and commercial—Sanders needs ambitious, creative engineers who will move ahead, for the success of the company can only be measured in terms of the success of our people.

We would enjoy the opportunity of discussing with you your future at Sanders Associates, Inc. Drop a note to D. H. Johnson outlining your experience and we will advise you promptly. Interviews can be arranged either in Nashua or in your area.



137 Canal St. Nashua, New Hampshire

GRADUATE ENGINEERS

Interested in

Hydraulics? Pneumatics?

Electronics?

Electro-Mechanical Devices?

DEVELOP YOUR PROFESSIONAL SKILLS WHILE DEVELOPING ADVANCED JET ENGINES

In General Electric's Aircraft Gas Turbine Division—Evdendale Plant

For an exceptional engineer — with the right combination of originality and technical competence — there is a stimulating opportunity here, to work with a small professional group in the important field of aircraft engine controls test equipment or facilities development.

General Electric is well known for its many diverse research and manufacturing activities. Advancement will be rapid, for a talented man. Special opportunities exist for engineers and mathematicians with advanced degrees and experience in jet engine testing, flight testing, and analog engine simulators to do advanced research in the field of engine simulation and controls systems development.

Please send complete details, in confidence, to:

MR. D. R. LESTER
 Technical Recruiting Bldg. 100
 AGT Division—Evdendale Plant

GENERAL ELECTRIC

Cincinnati, Ohio

ELECTRON TUBE ENGINEER:

Unusual opportunity for man with thorough background in development and pilot production of unconventional cathode ray tubes. Experience in electron tube and high vacuum techniques and in electron tube physics required. To work with and direct group in expanding section of Manhattan lab of well-known organization. Excellent compensation commensurate with proven experience and ability. Submit resume with salary requirement to: Box E 175, 221 W. 41 St. NYC, NY.

Farnsworth INTERNATIONAL TELEPHONE AND TELEGRAPH has a future for **ELECTRONIC ENGINEERS**

in these specialized fields

MISSILES

Research, systems analysis, development, and design in guidance and control systems, systems component equipment, and systems operational test equipment.

TEST EQUIPMENT

Research, development, and design in Guided Missile operational test equipment systems and systems component equipment.

MICROWAVES

Systems analysis, development, and design in microwave circuitry and components for missile guidance systems, radar systems, and systems test equipment.

RADAR

Study, analysis, development, and design in highly advanced radar techniques, and electronic countermeasures.

ANTENNAS

Research, development, and design of airborne antennas in low-frequency, UHF, and microwave regions for missiles, radar, and countermeasures equipment.

PACKAGING

Encapsulation and subminiaturization design for reliability and produceability in missile guidance and control equipment systems, airborne radar systems, operational systems test equipment, closed-loop TV systems, etc.

Career-minded men with several years specialized experience, and preferably with advanced degrees, are invited to join our rapidly expanding programs in industrial and military electronics.

Address inquiries to:

Technical Employment Manager

FARNSWORTH ELECTRONICS CO.,
Fort Wayne, Indiana
 A division of International Telephone and Telegraph Corp.

UNIVERSITY of MICHIGAN ENGINEERS and SCIENTISTS

Unusual opportunities for outstanding and experienced men are available at the University of Michigan's Willow Run Research Center. Research Engineers and Physicists with advanced degrees and/or experience in the fields of:

- DIGITAL COMPUTER • LOGICAL DESIGN • INFRARED • ACOUSTICS • DIGITAL COMPUTER PROGRAMMING ELECTROMAGNETIC THEORY • COMMUNICATIONS CIRCUIT DESIGN • COMPONENT DEVELOPMENT • RADAR • OPTICS ENGINEERING • SYSTEMS DESIGN

Salary commensurate with training and experience. Excellent working conditions. Liberal vacation policy along with other fringe benefits. Unusual opportunity to carry on University graduate studies while working full time. Moving expenses paid. U. S. Citizenship required.

Write, giving details of education and experience, to

A. J. Procassini
 University of Michigan
 Willow Run Research Center,
 Ypsilanti, Michigan

ENGINEERS Electronic • Mechanical DESIGNERS • DRAFTSMEN

How do you Measure success?

Some measure success only by money; others by the enjoyment they get out of their work. But the true measure of success is a combination of both *plus* the knowledge that your efforts are recognized and appreciated.

Melpar engineers find diversity and opportunity for professional growth; they enjoy being part of a highly creative staff without losing their individuality; and they benefit from Melpar's completely integrated facilities for system responsibility from design concept through production.

To learn how Melpar measures up to your own standards send complete resume to
 Technical Personnel Representative

melpar, inc.
 Subsidiary of Westinghouse Air Brake Co.
 3000 Arlington Blvd., Dept. E-23 Falls Church, Va.
 11 Galen Street, Watertown, Mass. • 99 First St., Cambridge, Mass.

- Network Theory
- Systems Evaluation
- Automation
- Microwave Technique
- UHF, VHF or SHF Receivers
- Analog Computers
- Digital Computers
- Magnetic Tape Handling Equipment
- Radar and Countermeasures
- Packaging Electronic Equipment
- Pulse Circuitry
- Microwave Filters
- Flight Simulators
- Servomechanisms
- Subminiaturization
- Electro-Mechanical Design
- Quality Control & Test Engineers

ENGINEERS

Say
"YES"
to a Life
With
Roots

If you are ready to put down roots . . . to embark on a permanent career with deep professional and personal satisfaction . . . General Precision Laboratory may have an opening for you.

There is a variety of long-range projects underway at GPL, a subsidiary of the large and diversified General Precision Equipment Corporation. We look for engineers who can contribute advanced ideas, sometimes pursuing an independent line, sometimes collaborating with experts in several fields. GPL men can count on recognition following quickly upon accomplishment.

Not the least of the advantages of working at GPL is the location in New York's well-known Westchester County. It's a particularly fine place to put down roots, with its beautiful countryside, modern homes and fine schools.

If your experience qualifies you for the work being done at GPL and you are looking for a stable future, send details of your background to Mr. Hollis F. Ware. Expenses will be paid for qualified applicants who come for interview. We regret we can consider only U. S. citizens.

GENERAL PRECISION LABORATORY INCORPORATED

A Subsidiary of General Precision Equipment Corporation

63 Bedford Road

Pleasantville, N. Y.

GPL DOES RESEARCH & DEVELOPMENT WORK IN:

. . . Electronics . . . Television, Motion Pictures . . . Aircraft & Missile Control, Guidance . . . Radar, Microwave . . . Systems Engineering: (aeronautical, industrial) . . . Precision Mechanics, Optical Devices . . . Instruments, Servos, Controls: (electro-mechanical, magnetic, electronic)

Outstanding Opportunities for Sales Engineers

to share in our
rapidly expanding program in

ELECTRONIC COMPUTER SYSTEMS

- Systems Analysis of Problems
- Application and Sales of Electronic Computers for control

Must have Electrical Engineering Degree

Several positions open—Major cities

Please Phone or write Dept.: N-17

Remington Rand

Division of Sperry Rand Corporation
Engineering Research Associates Division
1902 W. Minnehaha Avenue
St. Paul W4, Minnesota
Midway 6-9601

ELECTRONIC DEVELOPMENT ENGINEERS

Challenging DESIGN & DEVELOPMENT POSITIONS for CREATIVE ENGINEERS

These positions are tailor-made for highly imaginative engineers who enjoy problems of more than ordinary difficulty; problems that require a maximum of individual electronic creativity. Men selected will be entrusted with the complete electronic or electro-mechanical design and development tasks (initial circuits, systems, components, or product design) entailed in carrying a prototype project from original conception to its completion.

REQUIREMENTS: Senior and intermediate engineers with degrees and 4 to 8 years' experience; Junior engineers with degrees and 1 to 3 years' experience, capable of growing with our long-range, electronic design and development program in the following fields:

- | | |
|--------------------------|---------------------|
| (1) ANALOG COMPUTER | (4) ELECTRO-OPTICS |
| (2) RADAR BEACONS | (5) MISSILE SYSTEMS |
| (3) MAGNETIC AMPLIFIERS | (6) SERVOS |
| (7) FIRE CONTROL SYSTEMS | |

PROOF OF U. S. CITIZENSHIP REQUIRED

WE ARE LOCATED in a suburban area, at the Paramus exit of Garden State Pkwy., convenient to the N. J. Turnpike and only 15 minutes from Manhattan. If you choose, you can live nearby, avoiding the discomforts, costs and time wasted in commuting. Enjoy living in a clean, friendly community, minutes from work!

Interviews will be arranged at convenient locations. Send resume to:

AVION DIVISION OF ACF INDUSTRIES INCORPORATED

Route 17, Paramus, N. J. COlfax 1-4100

Only 15 minutes from
George Washington Bridge

ELECTRONIC ENGINEERS

GROW WITH ATOMIC ENERGY!

Here is an outstanding opportunity even in this era of plentiful jobs! Openings exist at all levels.

EXPERIENCE in pulse circuitry, DC amplifiers or automatic control will be most helpful.

CONSIDER these advantages . . .

- First and foremost company in the atomic field!
- Commercial work!
- Modern suburban plant under construction!
- Diversity of products and job security!
- Professional development in new field!
- And, of course, excellent fringe benefits and competitive salaries!

IF you are alert to new ideas and aggressive enough to pursue them . . . if you are capable of shouldering responsibility . . . if you would like to develop electronic equipment and systems for the new and exciting nucleonic industry . . . if you are looking for a real challenge . . . write in confidence to . . .

Tracertab

130 HIGH STREET, BOSTON 10, MASS.

Instrumentation and Components Sales Engineers

to share in our rapidly
expanding programs in

FACTORY AUTOMATION
PROCESS CONTROL
AUTOMATIC COMMUNICATIONS
INSTRUMENTS AND COMPONENTS
SALES

Must be qualified to combine
systems-analysis, applications,
and sales functions.

Several positions are to be filled
immediately by:

1. Chemical or Petroleum Engineer with heavy processing-instrumentation experience.
2. Electronics Engineer with heavy systems or components experience.
3. Electronics Engineer with heavy sales experience in communications equipment.
4. Engineers with combinations of above experience.

Please Phone or Write Dept.: N-13

Remington Rand

Division of Sperry Rand Corporation
Engineering Research Associates Division
1902 W. Minnehaha Avenue
St. Paul W4, Minnesota
Midway 6-9601

SALES ENGINEER

Well established (since 1934) small manufacturer of precision electronic instruments requires a Sales Engineer. We are located in a pleasant, active, rural community and our business is primarily commercial. Our personnel policies are modern and forward looking.

You will need a degree in EE and 3 to 5 years of engineering experience with electronic equipment or equivalent. Sales experience would be helpful but is not required.

Your work will include home office and field duties; demonstration of our instruments, customer technical assistance, and evaluation of customer needs. You will be paid a salary commensurate with your ability.

Please forward complete resume to

BOONTON RADIO CORPORATION
BOONTON, NEW JERSEY

HERE'S A CHANCE FOR A REAL CHANGE - - - -

Right Now there are some fine career positions open in the ever expanding electronics industry. Why not write us and weigh the advantages of working with a leader in the field —

Admiral Corporation

Your Opportunity may be listed below if you have background or interest in these fields:

RADAR — MILITARY AND COMMERCIAL

Gun laying, IFF and beacons, navigational aids, air traffic control, video processing and distribution systems.

TELEVISION — MILITARY AND COMMERCIAL

Mobile TV systems, cameras, complete systems including RF front ends, IF amplifiers and RF cavities in the UHF region.

Household TV section requires engineers at all levels who are capable of offering original ideas of values in highly competitive field, monochrome and color.

RADIO — MILITARY AND COMMERCIAL

Airborne and ground communication systems at HF, VHF and UHF level. Domestic and export receivers, HI FI and phonographs.

TRANSISTORS

Development group being augmented to explore all phases of transistor application.

PHYSICISTS

Research in, and analysis of, high level nuclear radiation effects on electronic components. This concerns original investigations at reactor levels.

TECHNICAL WRITERS

To organize, write and edit instruction books, operating and maintenance manuals for electronic equipment. Experience preferred, but will consider qualified trainees.

Admiral engineers know the satisfaction of creative work that gives them the opportunity to explore and expand new techniques in their field.

◦ *Let's discuss our mutual interests.*

Send complete resume to: Mr. Walter A. Wecker, Personnel Division

Admiral Corporation

3800 W. Cortland St.
Chicago 47, Illinois

INDUSTRIAL OPERATIONS RESEARCH OPENING

Extraordinary Career Challenge to your versatility and ingenuity now offered with integrated company active in many energy fields. Opportunity to apply optimization techniques at the staff level to all phases of operations.

Qualifications: Extensive analytical background in the physical sciences, engineering, or applied mathematics and statistics. Experience in Operations Research not necessary. Creative analysts with interest in entering Operations Research invited to submit resume.

Good Location: Modern, medium sized Southwestern community. Pleasant surroundings with excellent family recreation, religious and educational facilities.



Reply by letter giving age, experience and other qualifications. All applications carefully considered and kept confidential. Write:

**Employee Relations Manager
Research and Development Department
PHILLIPS PETROLEUM COMPANY
Bartlesville, Oklahoma**

SALES ENGINEERS WANTED

Excellent opportunities for several engineers with well established East Coast instrument manufacturer now expanding its line of aviation products which includes electronic and electro-mechanical components for jet engines and guided missiles.

Electrical engineering background essential. Must have established contacts with the aircraft industry. Openings in Los Angeles, Dallas, and East Coast areas.

Generous company paid benefits include hospitalization, pension, insurance, and vacation plans.

P-7255 Electronics
330 W. 42 St. New York 36, N. Y.

SALES ENGINEERS WANTED

Excellent opportunities for several engineers with well established East Coast instrument manufacturer now expanding its line of aviation products which includes electronic and electro-mechanical components for jet engines and guided missiles. Electrical engineering background essential. Must have established contacts with the aircraft industry. Openings in Los Angeles, Dallas, and East Coast areas. Generous company paid benefits include hospitalization, pension, insurance, and vacation plans.

P-7913, Electronics
330 W. 42nd St., New York 36, N. Y.

For a BETTER JOB in ENGINEERING The Swing's to



CHIEF RF ENGINEER

To design or supervise the design of Radio Frequency components for radar, radio equipment, antennas, horns, mixers, directional couplers, rotating joints and radomes. Must know cost estimating of this equipment and be able to advise shops on the best fabrication methods. Should be capable of setting up RF section. Approximately 10 years experience in design of RF components and systems.

SYSTEMS SPECIALIST

For the analysis of electronic system performance and establishment of design parameters for electronic systems. Must be able to prepare or supervise the preparation of technical proposals and act in the capacity of technical advisor on engineering program. Approximately 10 years experience in general electronic design work.

MECHANICAL ENGINEERS

Product Design, Production liaison on electronic packaging and mechanisms. Involves gear trains, printed circuits and electronic layout work. Knowledge of military specifications. Minimum 6 years experience in electronic equipment design and manufacture.

ELECTRONIC ENGINEERS

Experienced in Product Design and Production. Production liaison requires wide knowledge of electronic circuits and packaging. System and Component Testing. Some experience in cost estimating and project administration. Familiarity with all types of military specifications.

And remember that AMF is well-known for its liberal benefits program.

Please send complete resume to:
Personnel Manager, Electronics Division

American Machine & Foundry Co.

1085 Commonwealth Ave — Boston, Mass.

Engineers and Physicists

M.S. or Ph.D

Senior engineers and physicists with excellent grounding in fundamentals of both analytical and laboratory research and development are needed for new activities in computers, automatic controls, and electromechanical design. Men with versatility and leadership ability will be offered the opportunity to develop research programs along the lines of their own experience and interest within the wide scope of activities possible in an independent organization.

Write S. J. Keane, Physics Department

Southwest Research Institute
8500 Culebra Road, San Antonio, Texas

- ENGINEERS
- MATHEMATICIANS
- PHYSICISTS

... to develop
**NEW TECHNIQUES IN
 HIGH-SPEED COMPUTING**
 applied to advanced
 aircraft engine data

If you are interested in 3-dimensional puzzles and logical riddles, this rapidly expanding program at General Electric's Aircraft Gas Turbine Department will appeal to you.

Working in small groups, teams of GE specialists are making an intense study of new applications as well as new techniques of electronic computing equipment—including IBM 701 and 704.

Chances for rapid promotion are especially good, as the utilization of electronic computing for complex operations is accelerating in many departments of GE.

You'll work in Cincinnati, an excellent environment for family living.

Please send complete details, in confidence to:

MR. J. L. ROACH
 AGT Development Department

GENERAL ELECTRIC

Cincinnati, Ohio

COMMUNICATIONS ENGINEERS and TECHNICIANS

EXCELLENT SALARIES
 MINIMUM PREREQUISITES

ENGINEER EE Graduates with 3 years experience
TECHNICIAN 2 years technical school in communications and 3 years experience.

Require installation adjustment and maintenance experience with communication receivers and associated terminal equipment. Also, men with similar experience with high-powered transmitters, antennas, transmission lines.

Must be willing to travel in United States and Overseas.

Page Communications Engineers, Inc.
 710 Fourteenth St., N.W., Washington 5, D.C.

1. Engineers & Technicians 2. Field Electronics

5 year installation, maintenance in one or more of the following categories—
 AIRBORNE COMMUNICATIONS, NAVIGATION, RADAR.

DYNAMIC ELECTRONICS N. Y. INC.
 73-39 Woodhaven Boulevard
 Glendale, Long Island
 Illinois 9-7000 Extension 14

ELECTRONICS ENGINEERS

Preferably with college degree, but will consider some college with equivalent in experience.

For

Radio Component Analysis and Approval Laboratory
 . . . Subsidiary of Zenith Radio Corporation.

Excellent opportunity for growth . . . Ideal living conditions.

- Top Pay.
- Free Hospitalization, surgical and medical insurance.
- Liberal vacation plan.
- Group, life, sickness and accident insurance.
- Profit sharing plan.
- 7 paid holidays.
- A year-round recreational program.
- Moving expenses paid.

Apply F. S. Dale, Personnel Department, Win-charger Corporation, Sioux City, Iowa.

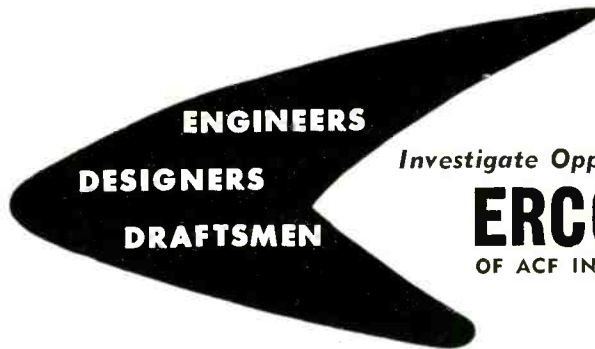

Investigate Opportunities at

ERCO DIVISION
 OF ACF INDUSTRIES INC.

ERCO Engineers have built a record of continuous progress and growth for themselves and for the Company for a quarter of a century . . . growth in physical plant, personnel, number and diversity of products and services.

Today this growth continues and we are constantly on the alert for new men to add fresh impetus to that progress . . . paying top salaries to capable people.

Your work will be interesting and stimulating . . . it might include electronic flight simulators, machine tools, guided missiles, or a variety of specialized electronic devices.

You can choose a home from a number of fine nearby residential areas convenient to both shopping centers and plant . . . and you can further your education at the many nearby Universities . . . you can enjoy suburban living and be within easy reach of the cultural advantages of the Nation's Capital.

ERCO now needs Electronic Engineers (all levels with some overseas positions available). Aerodynamicists, Analog Computer Engineers, Mechanical Design Engineers, and supporting personnel. Send resume or request for additional information to:

ERCO DIVISION
 OF ACF INDUSTRIES
 RIVERDALE • MARYLAND

ENGINEER MISSILE & WEAPONS CONTROL SYSTEMS STUDIES

Enjoy full use of your skill and imagination, and friendly, professional give and take with top men in the field of electromechanical precision equipment.

You will perform studies related to airborne weapons control and guidance systems with the object of determining requirements, feasibility, performance and specifications of computers and over-all systems.

A degree in physics, ME or EE—or the equivalent in experience—is required. Must be able to handle problems in such diversified fields as: digital computers, digital data transmission systems, logic counting and conversion circuits, high precision gyro and gimbal structures, dynamic behavior of missiles; alignment of inertial platforms for guidance systems, and flight evaluation of guidance systems and instrumentation. Send resume in confidence to:

Technical Personnel Dept. 2-500

ARMA

Division American Boscov Arms Corp.
 Roosevelt Field, Garden City
 Long Island, N. Y.

ELECTRONIC ENGINEERS

Technical Operations, Inc., is looking for an electronic engineer with three to five years of experience, capable of supplying original ideas in the fields of transistor circuitry and operations research instrumentation. Join an expanding research and development organization located in suburban Boston. Please send complete resume and requirements to:

R. R. SMYTH

**Technical Operations,
 Inc.**

6 Schouler Court Arlington 74, Mass.

ELECTRONIC ENGINEERS

Degree in Electrical Engineering or Physics with experience in servo-mechanism, electronic control devices, computer theory highly desirable.

SALES ENGINEERS

Engineering background essential. Experience in instrumentation desirable.

DESIGN ENGINEERS

Capable of responsible design in development projects in complex equipment. Background in Aeroelasticity, structural dynamics, machine design and electronics helpful.

THE CALIDYNE COMPANY

Manufacturers of Vibration Test Equipment

120 Cross Street

Winchester, Massachusetts

ELECTRONIC and ELECTRICAL ENGINEERS and PHYSICISTS

Armour Research Foundation has openings in Chicago, Illinois and Fort Huachuca, Arizona, for graduate engineers or physicists with experiences in one or more of the following areas:

- Radio and radar
- Electronic Instrumentation
- Communication systems evaluation
- Electric machine components, measurements.

These are permanent positions offering attractive salaries, liberal benefits, and excellent opportunities for personal and professional growth. Send resume to:

Mr. T. E. DePinto
Armour Research Foundation
of Illinois Institute of Technology
10 West 35th St.
Chicago 16, Illinois

REPRESENTATIVES WANTED

Manufacturer of electronic test equipment for military and commercial applications needs technically qualified representatives. Write giving qualifications, lines handled, territory covered.

RW-2178, Electronics
1111 Wilshire Blvd., Los Angeles 17, Calif.

**Additional
Selling Opportunities
on pages
432, 433 & 434**

PAN AMERICAN WORLD AIRWAYS, Inc.

Has immediate openings at the Air Force Missile Test Center, Cocoa Beach, Florida for

ELECTRONICS ENGINEERS

to develop and coordinate instrumentation and facility support for various Guided Missile test programs. BSEE, BS Physics or equivalent technical training required, with three to five years associated practical experience. Previous experience with Guided Missile activities desired but not essential.

Positions offer exceptional prospects for outstanding men, in dynamic new Missiles field. Excellent Company benefits, Group insurances, retirement, paid Sick Leave, liberal vacation and reduced-fare world-wide airline travel privileges.

Mail resume to Industrial Relations Department, Pan American World Airways, Guided Missiles Range Division, P. O. Box 308, Patrick Air Force Base, Florida.

NEED ENGINEERS

Place an "Engineers Wanted" advertisement in this EMPLOYMENT OPPORTUNITIES section. *It's an inexpensive, time saving method of selecting competent personnel for every engineering job in the electronic industry.* The selective circulation of ELECTRONICS offers you an opportunity to choose the best qualified men available throughout the industry.

**FOR RATES
OR INFORMATION**

About Classified Advertising,

Contact
*The McGraw-Hill
Office Nearest you.*

ATLANTA, 3
1321 Rhodes-Haverty Bldg.
Walnut 5778
W. D. LANIER

BOSTON, 16
350 Park Square
HUBard 2-7160
P. McPHERSON

CHICAGO, 11
520 No. Michigan Ave.
MOhawk 4-5800
H. BOZARTH
W. HIGGENS

CLEVELAND, 15
1510 Hanna Bldg.
SUperior 1-7000
C. J. LOUGHLIN

DALLAS, 2
Adolphus Tower Bldg., Main
& Akard Sts.
PRospect 5064
J. CASH

DETROIT, 26
856 Penobscot Bldg.
WOodward 2-1793
L. SEEGAR

LOS ANGELES, 17
1111 Wilshire Blvd.
MAdison 6-4323
C. DYSINGER

NEW YORK, 36
330 West 42 St.
LONacre 4-3000
W. SULLIVAN
D. COSTER
R. LAWLESS

PHILADELPHIA, 3
17th & Sansom St.
RIttenhouse 6-0670
J. WILLIS

ST. LOUIS, 8
3615 Olive St.
LUcas 4867
H. BOZARTH

SAN FRANCISCO, 4
68 Post St.
DOuglas 2-4600
T. CARMODY
R. ALCORN

ENGINEERS

OPPORTUNITIES IN
DESIGN & DEVELOPMENT

SENIOR ENGINEERS For gyro system development projects, and electrical engineers with experience in design and development of circuitry for air-borne gyro mechanisms, servo mechanisms and their related systems.

ELECTRONIC ENGINEERS To work on autopilot systems development & design or investigations, evaluation and testing of systems involving interacting servo loops, servo sub-systems, circuitry including audio frequency amplifiers, magnetic amplifiers, and switching systems.

DESIGN ENGINEERS For design and layout of gyro instrument components for aircraft flight control systems. Will consider top-grade machine designers experienced on intricate precision mechanisms with engineering degree.

ENGINEERS AIR DATA Development engineers for master air data systems to be designed specifically for inputs. Requires knowledge of altitude, altitude rate, mach, air speed sensors and instrument servo theory and practice.

We are located in Grand Rapids, Michigan, a good clean & modern city of 200,000 where recreational & cultural opportunities are the finest.

Competitive salaries. Generous moving allowance. All replies held confidential.

Interviews arranged at company expense with selected applicants.

Send complete resumes to:
Personnel Manager



LEAR, INC.

110 Ionia Ave. N. W.
Grand Rapids, Mich.

ELECTRICAL, ELECTRONIC AND MECHANICAL ENGINEERS DRAFTSMEN

Experienced engineers and draftsmen required immediately for important design and development assignments in the challenging electronic flight simulator, missile launcher, control engineering and selenium rectifier programs.

Internationally known organization offering liberal pension, hospital, surgical benefits and vacation plans. Salary commensurate with ability.

You and your family will enjoy your career with Union Switch & Signal in the growing engineering center of tomorrow—the "New" Pittsburgh.

Send resume to Personnel Manager.

UNION SWITCH & SIGNAL

Division of Westinghouse Air Brake Company
Pittsburgh 18, Penna.

Electronics Engineers

expanding helicopter
field offers you
excellent opportunities

Both Junior and Senior electronics engineers are needed to work with those who design, test, and build rotary wing aircraft.

Challenging positions are open to men with experience or a good educational background in:

Radar
Flight Test Instrumentation
Strain Gage Circuitry
Oscillographic Data Recording Systems
Vibration and Temperature Measuring Systems
Work on Automatic Control Systems—
both test and development
Automatic Pilot and Blind Flying Instrumentation

Not only will your professional achievements be recognized, but you and your family will enjoy many personal benefits.

Apply in person or send complete resume to

R. L. Auten, Personnel Department

SIKORSKY AIRCRAFT

Bridgeport 1,

Connecticut

PRODUCT ENGINEERS

Challenging positions for five ENGINEERS or PHYSICISTS who are interested in being associated with a leading instrument company.

MECHANICAL ENGINEERS experienced in design and development of electromechanical instruments including production engineering follow-up. **ELECTRICAL ENGINEERS OR PHYSICISTS** experienced in:

- Analyzing operations of vacuum tube amplifiers and servo-systems and devising corrective solutions where performance is substandard.

- Specifying electrical components and supervising their placement within an electrical system.

We design and manufacture a variety of instruments and systems for analysis and control: infra-red spectrophotometers, and continuous analyzers, nuclear magnetic resonance equipment, and gas chromatography instruments. . . Also we design and manufacture precision optics and optical systems.

For consideration please contact or submit detailed resume to Personnel Manager.

THE

PERKIN-ELMER CORPORATION

MAIN AVENUE NORWALK, CONN.

ELECTRONIC ENGINEERS

Research & Development
Physicists - Engineers
(SENIORS)

Experienced in research and development of various radar systems including: beacons, missile guidance and counter measures. Advanced training in applied mathematics, noise theory and probability analysis desirable. EE degree or equivalent required.

FIELD ENGINEERS (SENIORS)

Local & Field Assignments

Must have EE degree, with 3-5 years experience in one of the following:

- Flight Simulators
- Radar & Sonar Trainers
- Fire Control Radar
- Electronic installation and maintenance.

● EQUIPMENT ENGINEERS

3-5 years experience with at least 3 years in circuit packaging. EE degree with mechanical background.

● APPLICATION ENGINEERS

5-10 years experience on coil and transformer development.

Salary and advancement commensurate with ability; liberal vacation, sick leave, 9 paid holidays, group life, sickness and accident insurance plans, and a worthwhile pension system.

STAVID

Engineering, Inc.

U. S. Highway 22, Watchung, P. O.
Plainfield, N. J.—Plainfield 7-1600

SEARCHLIGHT SECTION

(Classified Advertising)

BUSINESS OPPORTUNITIES

EQUIPMENT - USED or RESALE

UNDISPLAYED

\$2.10 a line, minimum 3 lines. To figure advance payment count 5 average words as a line. BOX NUMBERS count as one line additional.

DISCOUNT of 10% if full payment is made in advance for four consecutive insertions.

Send NEW ADVERTISEMENTS to N. Y. Office, 330 W. 42nd St., N. Y. 36, N. Y. for December issue closing November 3rd.

The publisher cannot accept advertising in the Searchlight Section, which lists the names of the manufacturers of resistors, capacitors, rheostats, and potentiometers or other names designed to describe such products.

RATES

DISPLAYED

The advertising rate is \$18.50 per inch for all advertising other than on a contract basis. AN ADVERTISING INCH is measured 7/8" vert. on a column, 3 cols.—30 inches—to a page. EQUIPMENT WANTED or FOR SALE ADVERTISEMENTS acceptable only in Displayed Style.

Specialists in TUBES

All Famous Name Brand Radio and TV Receiving Tubes, Transmitting tubes, Special Purpose Tubes

You get immediate delivery on these high quality, low priced tubes taken from one of the most extensive selection of tubes available. Order now!

We handle such brands as: Hallicrafters, National Union, Zenith, Admiral, Stewart-Warner, Raytheon, RCA, Philco, Sylvania, Crosley, G.E., Motorola, Testron.

SPECIALS: Transmitting Tubes

5654	\$1.00	3B28	\$2.00
5725	\$2.24	2C46	\$6.00
2D21	.81	6AS6	\$1.75
6080	\$2.00	HF200	\$6.00

This is just a partial list of types available. Phone or mail your order. Send for our complete tube listing.

B & C DISTRIBUTORS COMPANY

180 Spring Street • Paterson, N. J.
MULberry 4-4010

Surplus Industrial ELECTRONICS Components Equipment

TEST SET—MODEL OAP-1—Power source 115 V 50-400Z. Complete with cables, calibration charts. Exc. cond. Ready to plug in and use.....\$49.95

TEST SET—TS 173/UR—Power Source 115-v 60Z. Complete with calibration book, spare tubes, and crystal. This is the high frequency version of the LM and HC221 frequency meter. Excellent condition.....\$150.00

LORAN RECEIVER—MODEL DBE—Power Source. 115/210-v 50-60 cy type C6-46265 indicator. Good cond. w/all tubes.....\$75.00

STEP DOWN XFORMER—Available in production quantities—115-v-60 to 28-v-1.5 amps. Open frame constr. Lots of 100—\$1.00 ea. Lesser quant. \$1.59 ea. Write for large quant. price.

WESTERN ELECTRIC STEPPER SWITCH—Production quantities—Coil voltage from 4.5-v to 12 VDC—14 steps. 4 decks. D182768—ea. \$7.95—50 @ \$5.00—Quantities—write.

VIBRAPACK—PE-104—P.O. Ser 284—Exc. cond. \$9.95 ea.

VIBRAPACK PE-204—New—Orig. pack.....\$2.50

RADAR UNIT T42—UPT-T1—This is a complete installation—Power supply (115-v-60 cy) radar unit, antenna, meter, all cables, instruction book—Br. new in wooden crate—\$60.00 complete.

SQ RADAR—A complete radar unit. Ready to operate used, but operating cond. Low Price.

WESTERN ELECTRIC POWER SUPPLY—Input 115 VAC 60Z—output 115 VDC 600 MA. Regulated Filtered. Beautiful construction, all UP components. With diagram (Bell Labs) Brand new ±6S 800156. \$29.95

LAE 516. Gen. Used. With calib. curves. 115-v-60v.....\$79.95

1625 TUBES—Large lot—Individual boxed. Lots of 100—22c; Lots of 600—17c; Lots of 1200—15c.

REX RADIO SUPPLY CO.
88 CORTLANDT ST. N.Y. 7, N.Y.
Phone CO-7-1617—Prices F.O.B. N.Y.

★ MANUFACTURERS

Let us handle technical sales representation of your products

★ INVENTORS

We will share the cost of protecting your invention if accepted for commercialization

We Specialize in Electronics, Nucleonics, Instrumentation, Servomechanisms & Cybernetics.

R. W. HODGSON CO.

Technical Sales Representation & Research & Development Engineering

3406 W. Washington Blvd. Los Angeles 18, Calif.
REpublic 2-2651

NOTICE

United States Patent No: 2,686,266
"Improvements in Radiation Detectors"
Non-exclusive licenses upon royalties of 1% may be obtained by qualified manufacturers under the above United States Patent for all uses except in well bores.

Infringers will be rigorously prosecuted.

For further information contact:

FETHERSTONHAUGH & KENT,

Patent Attorneys,

505 GREAT WESTERN BUILDING,

WINNIPEG, MANITOBA, CANADA

PUBLICATIONS

For Sale complete set of Electronics 1941-1955 very reasonable. R. B. Hall, 6431 Euclid Ave., Hammond, Indiana.

WANTED

WILL BUY ALL

ART-13 T47A Transmitters BC-348 Rec'r Modified \$25.00
ART-13 T47 Transmitters BC-348 Rec'r Unmodified \$50.00
BC-788 Altimeters \$160.00 ARC-1 Radio Complete \$250.00
ARC-3 Complete \$185.00 BC-312 Receiver \$40.00
RS/ARN-7 Radio Compass \$175.00 BC-342 Receiver \$50.00
Ship via Express C.O.D. Subject to inspection to H. FINNEGAN
49 Washington Ave. Little Ferry, N. J.

MUST HAVE FOR CURRENT ORDERS

PHONE COLLECT
BC-312 BC-314 BC-610
BC-342 BC-344 T-47/ART-13
R-5/ARN-7 ATC/ART-13

SEMLER INDUSTRIES INC.

Stanley 7-1554
6853 Lankershim Boulevard
North Hollywood, California

WANTED

ELECTRONIC TUBES, all types. Also want all types airborne electronic equipment: ART-13; BC-788; I-152; ARC-1; ARN/7, etc. Top dollar paid!

BOB SANETT, W6REX

1524 S. Edris Dr.
Los Angeles 35, California

Employment Opportunities

ADVERTISERS INDEX

Accredited Personnel Service.....	409, 410
Admiral Corporation.....	433
American Bosch Arma Corp Arma Division.....	424, 427, 435
American Machine & Foundry.....	434
AVCO Mfg. Corp. Crosley Division.....	414
Avion Division of ACF Industries Inc.....	432
Bendix Aviation Corp. Pacific Division.....	412, 416
Products Division.....	421
Radio Division.....	415
Research Laboratories.....	428
York Division.....	426
Boonton Radio Corp.....	433
Bomac Laboratories Inc.....	422
Burroughs Research Center.....	417
Calidyne Co.....	435
Cardwell Electronics Prod. Corp., Allen D. Convair, A Div. of General Dynamics Corp. San Diego, Calif.....	427
Pomona, Calif.....	423
Cook Research Laboratory.....	429
Cornell Aeronautical Laboratory Inc.....	414
Decision Inc.....	422
Dorsett Laboratories Inc.....	425
Drake Personnel Inc.....	409, 410
Dynamics Electronics.....	435
Electronic Engineering Co. of Calif. Engineering & Research, A Division of ACF Industries Inc.....	424
Farnsworth Electronics Co.....	431
Federal Telecommunication Labs.....	412
General Electric Co.....	425, 426, 430, 435
General Motors Corp. AC Spark Plug Division.....	424
General Precision Lab Inc.....	432
Goodyear Aircraft Corp.....	413
Instruments for Industry Inc.....	424
Johns Hopkins University, Applied Physics Lab.....	429
Lear Inc.....	425, 437
Maryland Electronic Mfg. Corp.....	420-428
Melpar Inc.....	431
Monarch Personnel.....	409, 410
National Co., Inc.....	410
North American Aviation Inc.....	420
North Electric Co.....	423
O'Shea Employment System.....	409, 410
Page Communication System.....	435
Pan American World Airways Inc.....	436
Perkin-Elmer Corp.....	437
Phillips Petroleum Co.....	434
Radio Corp. of America.....	411
Raytheon Mfg. Co. Missile and Radar Division.....	412
Waltham, Mass.....	425, 427
Wayland, Mass.....	429
Remington Rand, Div. of Sperry Rand Corp., Engineering Research Assoc. Div.....	414, 419, 432, 433
Remington Rand, Eckert-Mauchly, Div. Sperry Rand Corp.....	422
Republic Aviation Corp.....	428
Sanders Assoc. Inc.....	430
Sikorsky Aircraft.....	437
Sorensen & Co., Inc.....	428
Southwest Research Institute.....	434
Stavid Engineering, Inc.....	437
Stromberg-Carlson Co.....	428
Sylvania Electric Products, Inc. Buffalo, N. Y.....	416
Waltham, Mass.....	416
Mountain View, Calif.....	418
Technical Operations Inc.....	435
Texas Instruments, Inc.....	430
Tracerlab Inc.....	432
Transitron Electronic Sales Corp.....	409, 410
Union Switch & Signal University of Michigan.....	437
Vitro Corp.....	426
Westinghouse Electric Corp. Electronic Tube Division.....	428-436
Wincharger Corp.....	435

This index is published as a convenience to the readers. Care is taken to make it accurate but CLASSIFIED assumes no responsibility for errors or omissions.

SPECIAL PURPOSE TUBES

OA2	\$.75	3B26	3.00	6J4	3.00	VR-105	.70	WE-336A	5.00	GL-803	2.00	1692	1.50
OA3	.90	3B27	3.00	6J6W	1.25	VU-1115	1.00	WE-337A	6.00	803	1.40	1623	2.35
OA5	4.00	3B28	5.50	6L6WGB	3.35	HY-114B	.75	WE-339A	12.50	804	9.00	1624	.95
OB2	.75	3B29	6.75	6SC7GT	2.00	WE-121A	3.50	WE-347A	3.50	805	4.50	1625	.30
OB3	.75	3B31	2.50	6SK7Y	.35	WE-122A	1.50	WE-348A	5.00	806	7.50	1626	.25
OC3	.70	EL-3C	5.50	6SN7WGT	2.00	F-123A	5.00	WE-349A	7.50	807	1.20	1629	.25
OD3	.70	EL-3CJ	7.00	6SU7GT	2.25	WE-123A	5.00	WE-350A	2.85	807W	4.00	1630	.40
EL-C1B	2.00	3C22	60.00	7BP7	5.00	WE-124A	3.75	350B	2.85	808	1.40	1631	1.40
EL-1C	1.50	3C23	3.50	7CP1	15.00	VT-127A	2.50	WE-351A	6.00	809	2.70	1632	.50
1B22	1.35	3C24	2.50	7EP4	10.00	F-128A	15.00	WE-352A	15.00	810	10.00	1633	.75
1B23	3.00	3C31	2.00	9GP7	5.00	HF-130	.90	F-353A	2.00	811	2.75	1634	1.35
1B24	5.50	3C33	9.50	9LP7	3.50	VR-150	.70	WE-353A	3.50	811A	3.50	1635	1.50
1B27	10.00	3C37	10.00	9MP7	7.50	FG-154	15.00	WE-354A	14.00	812	2.25	1636	1.00
1B32	1.00	3C45	6.00	10Y	.25	HK-154	5.00	WE-355A	15.00	814	1.75	1641	1.35
1B35	4.50	3D21A	5.00	CE-11V	2.50	VT-158	9.75	WE-359A	3.00	815	1.50	1642	.50
1B36	3.75	3D22	9.75	12A6	.50	FG-166	15.00	WE-368AS	2.00	816	1.25	1644	1.00
1B38	30.00	3DP1	3.75	12DP7A	35.00	FG-172	15.00	371A	1.50	822	10.00	1649	1.00
1B40	2.35	3DP1A	7.50	12GP7	17.50	QK-181	20.00	371B	1.50	825	.75	1654	3.50
1B42	4.50	3E29	8.50	12J5WGT	1.50	FG-190	7.50	F-375A	12.50	828	7.50	1655	2.00
1B59	10.00	3EP1	2.00	12K8Y	.50	HF-200	10.00	WE-393A	5.00	829	6.00	1656	6.50
1C21	2.00	3FP7	2.00	12L8GT	.85	CE-201	2.75	394A	1.85	829B	8.50	1661	6.00
1P23	2.00	3FP7A	3.50	LM-15	50.00	CE-203	5.00	WE-394A	3.50	830B	.85	1846	50.00
1P30	2.00	3GP1	2.50	NE-16	.30	303A	3.75	WE-396A	3.00	832	3.75	1851	1.75
1P32	1.00	3HP7	3.00	FG-17	3.25	303Z	5.00	WE-404A	10.00	832A	5.00	1904	10.00
1P34	1.75	3J21	50.00	RK-19	.85	304A	25.00	410R	100.00	833A	30.00	1960	.50
1P36	2.50	3J31	35.00	RK-20A	8.00	WE-205B	.75	WE-417A	12.00	834	5.75	1984	10.00
1Z2	2.00	3K27	150.00	TZ-20	1.75	207	50.00	WL-417A	3.50	835	5.00	2000T	150.00
VG-2	10.00	3KP1	7.25	CE-21C	3.00	211	.50	WE-418A	12.50	836	2.00	2050	1.00
2AP1	4.00	3RP1	7.25	RK-21	.85	WE-211C	10.00	WE-421A	14.00	837	.90	2051	.65
2AP1A	5.00	4.400A	40.00	RK-22	3.50	WE-211D	8.00	GL-434A	10.00	838	.90	2172	12.50
2AS15	5.00	KC-4	50.00	CE-23C	1.40	WE-212E	25.00	446A	.50	842	2.25	2183	5.00
2B21	1.00	4AP10	3.75	PJ-23	2.00	217A	1.50	446B	1.85	843	.35	ZB-3200	75.00
2B26	1.25	4B22	6.50	RK-23	2.50	217C	3.00	450TH	35.00	845	5.00	R-4100	6.25
2C21	.50	4B23	7.50	HK-24	2.85	WL-218	20.00	450TL	35.00	845W	8.50	R-4330	10.00
2C22	.35	4B24	5.50	HK-24G	2.00	CE-220	.50	451	5.00	849	22.50	5528	3.75
2C24	.75	4B25	8.00	CE-25A B	2.00	CE-221	8.00	WL-460	10.00	851	10.00	5550	25.00
2C25	.35	4B26	3.00	RK-25	2.50	221A	2.00	464A	2.25	852	5.00	5551	25.00
2C26A	.50	4B27	2.75	25T	2.85	CE-222	1.50	WL-468	15.00	860	3.00	5553	100.00
2C33	.75	4B28	2.75	25TG	2.50	CE-224	5.50	RH-507	35.00	861	15.00	5556	6.75
2C34	.35	4B30	.75	FG-27A	12.00	CE-225	3.00	CK-510AX	.50	864	.35	5557	3.25
2C38	10.00	4B32	10.00	CE-28D	2.50	CE-226	3.00	WL-525	15.00	865	.50	5560	20.00
2C39	7.00	4C22	7.50	RK-28	2.50	WE-231D	2.00	527	25.00	866A	1.10	5610	1.00
2C39A	10.00	4C25	3.00	28D7	.75	RX-233A	.75	WL-530	25.00	866 JR	1.25	5625	50.00
2C40	7.50	4C27	3.50	23D7W	1.50	CE-235A	5.00	WL-531	7.50	868	2.00	5632	7.50
2C42	12.50	4C35	15.00	CE-29	1.25	235R	25.00	WL-532A	1.00	869B	24.50	5645	6.50
2C43	7.50	4E27	8.75	CE30C	1.25	WE-242A	5.00	WL-535	10.00	GL-872A	2.50	5650	85.00
2C44	.35	4J52	35.00	Twin 30	7.50	WE-242C	8.00	WL-538	.50	CE-872A	1.50	5651	1.35
2C46	6.00	4X100A	20.00	HY-30Z	2.65	WE-249B	2.50	GL-553	2.00	872A	1.35	5654	1.50
WE-2C51	3.00	EL-5BHD	7.50	CE-31V	2.40	WE-249C	2.50	559	.50	874	.50	5656	7.00
2C53	10.00	EL-5B2.5	6.50	FG-32	6.00	250R	4.75	GL-564	1.50	876	.75	5670	1.85
2D21	.65	5AP1	2.00	FG-33	15.00	250TH	18.50	575A	12.50	878	.50	5687	2.50
2D21W	1.40	5B21	2.00	RK-33	.50	250TL	15.00	WL-579B	10.00	879	.35	5691	4.75
2E22	2.00	5BP1	2.50	RK-34	.35	WE-251A	47.50	KU-610	4.75	884	1.00	5696	1.00
2E24	2.25	5BP1A	10.00	35T	4.50	WE-252A	9.50	HY-615	.50	885	1.00	5703	1.15
2E25	1.85	5BP2A	6.00	35TG	3.00	WE-253A	3.50	WL-629	1.25	902P1	3.00	5720	11.50
2E26	3.25	5BP4	2.50	RK-38	6.50	WE-254A	6.00	WL-630	1.00	905	2.00	5725	1.90
2J21A	2.75	5C21	6.00	RK-39	1.50	HK-257B	9.00	631-P1	5.75	913	15.00	5726	.75
2J26	4.75	5C22	28.00	T-40	2.35	WE-257A	3.50	WL-632A	17.50	917	2.50	5728	9.00
2J27	4.75	5C30	1.00	TZ-40	3.50	FG-258A	100.00	WL-655/658	100.00	918	2.00	5740	44.00
2J29	15.00	5CP1	2.00	CE-42C	1.50	WE-259A	12.50	WL-670A	8.00	919	2.25	5763	1.00
2J30	15.00	5CP1A	10.00	RK-44	1.00	WE-261A	10.00	WL-681x686	25.00	920	3.00	5801	2.50
2J31	14.50	5CP7	7.00	QK-47	50.00	WE-262B	7.00	WE-701A	2.00	921	1.00	5819	25.00
2J32	14.50	5D21	6.50	RK-47	1.75	WE-264C	3.00	709A	.50	922	1.20	5827	2.50
2J33	14.50	5D23	7.00	CE-48	1.75	WE-267B	10.00	709B	1.00	923	1.40	5829	1.00
2J34	14.50	5FP7	1.35	RK-49	2.85	WE-268A	7.50	703A	1.50	924	1.35	5842	12.00
2J36	15.00	5FP1A	5.00	HY-51B	.85	FG-271	25.00	WE-704A	.85	925	2.00	5847	10.00
2J37	5.00	5GP1	5.00	FP-54	44.00	WE-272A	5.00	705A	.75	926	2.50	5932	4.00
2J38	10.00	5J29	7.50	HK-54	2.00	WE-274A	4.00	707A	3.50	927	1.00	5933	4.00
2J39	10.00	5J30	5.00	T-55	3.50	WE-274B	2.00	707B	4.50	928	2.50	5948	250.00
2J40	15.00	5J32	20.00	RK-57	4.50	274B	.75	WE-708A	.75	929	1.25	5963	.90
2J50	35.00	5JP1	15.00	RK-58	.90	WE-275A	5.00	WE-709A	1.00	930	1.25	5981/5650	85.00
2J51	150.00	5JP2	7.00	QK-59	25.00	276A	3.00	710A	.50	931A	2.50	5998	15.00
2J53	25.00	5JP4	7.00	QK-60	25.00	WE-282A	7.50	713A	.35	954	.30	6031	4.75
2J54	50.00	5JP5A	7.00	RK-60	1.35	WE-283A	4.00	714AY	25.00	955	.35	R-6160	2.00
2J55	50.00	5JP11	10.00	HY-61	1.25	WE-285A	5.00	715A	2.00	956	.35	R-6175B	1.00
2J56	75.00	5LP1	7.50	QK-61	25.00	WE-286A	6.00	715B	4.00	957	.35	R-6200	.65
2J61	15.00	5LP1A	25.00	RK-61	3.00	287A	3.50	715C	12.00	958A	.35	R-6210	15.00
2J62	4.75	5NP1	2.50	QK-62	25.00	WE-295A	5.00	WE717A	1.00	959	1.50	UX-6653	.75
2J62A	50.00	5R4GY	.90	RK-62	1.75	WE-296A	25.00	717A	.50	991	.30	8001	8.75
2JB51	.35	5R4WGY	2.25	RK-63	20.00	HF-300	17.50	WE-719A	9.50	1000T	100.00	8002R	18.50
2K25	12.50	5X3	3.00	HY-65	1.85	WE-300B	5.00	721A	.75	CK-1005	.25	8005	4.25
2K28	35.00	5Z2P7	75.00	RK-65	7.00	CE-302	3.50	721B	7.25	CK-1006	2.00	8008	6.00
2K30	100.00	5Z4P11	150.00	FG-67	9.00	EL-302.5	5.00	722A	3.50	CK-1007	.75	8011	.50
2K33A	65.00	EL-C6A	6.00	RK-69	2.00	CE-303	2.25	723A/B	9.00	CK-1009	5.00	8012	1.00
2K41	75.00	EL-C6J	5.00	RK-72	.50	WE-304B	7.50	WE-724A	.85	CK-1026	3.00	8012A	2.50
2K45	45.00	EL-C6L	3.75	RK-73	.50	304TH	8.50	WE-724B	.85	R-1100	5.00	8013	2.75
2K54	10.00	EL-C6C	8.00	HY-75	3.00	304TL	15.00	WE-725A	3.25	R-1130B	10.00	8013A	3.75
2K55	7.50	6ACTW	.85	RK-75	.85	WE-305A	3.00	WE-726A	6.00	1500T	85.00	8016	2.50
2P21 (imag-		6AJ5	1.15	VR-75	1.00	307A	.85	WE-726B	25.00	1602	2.25	8020	1.25
orthicon	50.00	6AJ6	2.00	75TL	4.75	CE-309	3.25	WE-726C	22.50	1603	3.40	8021	.75
2X2	.35	WE-6AK5	1.35										

POWER RHEOSTATS

Over 25,000 Rheostats for immediate shipment

25 WATT			50 WATT			100 WATT		
Ohm	Shaft Length	Price	Ohm	Shaft Length	Price	Ohm	Shaft Length	Price
1.3	5/16"	69c	.25	5/16"	5.99	10	7/16"	2.19
4	7/16"	79c	2	7/16"	1.09	10	SS	2.09
10	7/16"	79c	8	7/16"	1.09	37	7/16"	2.19
12	7/16"	79c	10	7/16"	1.09	109	7/16"	2.19
15	7/16"	79c	12	7/16"	1.09	250	SS	2.19
20	7/16"	79c	15	7/16"	1.09	5000	SS	2.23
25	7/16"	79c	20	7/16"	1.09	10000	SS	2.39
30	7/16"	79c	22	7/16"	1.09			
40	7/16"	79c	50	7/16"	1.95			
70	3/8"	79c	75	7/16"	1.95			
75	1/8"	68c	80	7/16"	1.09			
180	7/16"	79c	90	1/2"	1.09	35	7/16"	2.85
108	7/16"	79c	125	7/16"	1.09	100	7/16"	2.85
125	7/16"	79c	125	7/16"	1.09	400	7/16"	2.85
160	3/8"	79c	150	9/16"	1.09	500	1/2"	2.85
185	7/16"	79c	250	SS	1.09	8000	9/16"	3.19
200	7/16"	79c	300	7/16"	1.95			
250	3/8"	79c	500	7/16"	1.09			
350	7/16"	79c	1000	SS	1.09			
370	7/16"	79c	1800	7/16"	1.09			
500	SS	68c	10000	7/16"	1.29			
750	7/16"	69c						
1000	SS	69c						
2500	SS	69c						
5000	1 1/8"	89c						
3000	SS	79c						
4000	SS	79c						
5000	SS	79c						

PRECISION WIREWOUND RESISTORS

1/4 WATT - 30¢					
OHMS	OHMS	OHMS	OHMS	OHMS	OHMS
.12	10.8K	13.52	105.8	301.8	2.193
.22	11.25	13.85	123.8	366.6	2.850
2.5	11.74	14.98	125	414.3	3.500
6.8	12.32	16.37	147.5	705	36.000
10.48	13.02	16.84	220.4	723.1	59.148
	13.15	79.81			

1/2 WATT - 35¢					
OHMS	OHMS	OHMS	OHMS	OHMS	OHMS
.25	46	270	4.300	14.825	36.000
.334	52	288.3	4.451	15.000	37.000
.444	55.1	480	5.000	15.750	43.000
.502	66.6	500	5.900	16.700	45.000
.557	76	850	6.500	17.000	50.000
.76	90	1.500	6.650	25.000	59.000
1	97	2.250	7.000	30.000	68.000
1.01	125	2.580	7.300	32.700	100.000
1.53	180	3.000	7.500	32.888	120.000
2.04	210	3.427	8.000	33.000	180.000
2.35	250	4.000	8.800	34.000	200.000
13.3	260		10.000	35.888	500.000
26			12.000		

1 WATT - 45¢					
OHMS	OHMS	OHMS	OHMS	OHMS	OHMS
.2	3.39	420	5.000	15.000	56.000
.725	5.21	425	8.250	20.000	60.000
.861	15	2.200	9.000	30.000	68.000
1.81	3.000	3.000	10.000	40.000	84.000
2.58	250	3.300	12.000	50.000	
2.66	270		55.000		

1 WATT - 60¢					
OHMS	OHMS	OHMS	OHMS	OHMS	OHMS
100.000	130.000	220.000	270.000	320.000	590.000
105.000	132.000	240.000	296.000	348.000	600.000
120.000	150.000	250.000	297.000	390.000	680.000
128.000	175.000	260.000	300.000	520.000	700.000
				622.000	

Orders f.o.b. Philadelphia

Minimum order \$3.00

WRITE TO BE PLACED ON OUR MAILING LIST

WALNUT 2-3553

ARCH ELECTRONICS CO.

634 ARCH STREET PHILADELPHIA 6, PA.

LOW-VOLTAGE TRANSFORMERS

New Release of Government Surplus Material Model #S-9527. KENYON TRANSFORMER CO. — 2.2 KVA. Input 110/220 Volts 50/60 Cy. Output 11 Volts C-T (5.5-0-5.5) At 200 Amperes! Continuous Duty. Case Size 8 1/2 x 10 1/2 x 13 1/2".

Price Brand New Only \$23.95 Ea. #S-9527 WE. — WESTINGHOUSE. — Same Specs. But Single 115 V Input & Lighter Wt. NEW \$23.95 DOZENS OF USES FOR INDUSTRIALS, TESTING LABS, EXPERIMENTAL UNITS & SCHOOLS

★ Heavy-Duty Soldering ★ Dip-Soldering ★ Plating ★ Battery-Chargers ★ Spot-Welding ★ Welding ★ Magnetizers ★ Heat-Treating ★ Electro-magnets ★ Testing - Tubes, Coils, Breakers & Relays.

Terms: Prices FOB St. Louis. Cash With Orders Well Rated Concerns (D&B) Net 10 Days Cash. McNEAL ELECTRIC & EQUIPMENT CO. 4736 Olive St. Dept. E-11 St. Louis 8, Mo.

U. S. GOV'T SURPLUS

ELECTRONICS FOR EXPORT

Semler Industries Inc.

6853 Lankershim Boulevard

North Hollywood, California, U.S.A.

AN/APR-4 LABORATORY RECEIVERS

Complete with all five Tuning Units, covering the range 38 to 4,000 Mc; wideband discone and other antennas, wavetraps, mobile accessories, 100 page technical manual, etc. Versatile, accurate, compact—the aristocrat of lab receivers in this range. Write for data sheet and quotations.

We have a large variety of other hard-to-get equipment, including microwave, aircraft, communications, radar; and laboratory electronics of all kinds. Quality standards maintained.

NEW TS-13/AP X-BAND SIGNAL GENERATORS with manual \$575.00; T-47A/ART-153 Transmitters, \$450.00; H-P, Boonton, G-R, Measurements, many others in stock.

ENGINEERING ASSOCIATES

434 PATTERSON ROAD

DAYTON 9, OHIO

Diehl Midget PM Motor \$3.95 KS-15098-LO1 27 VDC

Utah Pulse Transformers 9262...\$6.95 9280...\$7.95

T-17 MIKE \$6.95 Used—Excellent

BL-221 FREQUENCY METER \$115.00

SELSYN C78248 ea...\$6.95 Differential C78249 ea...\$2.95 Mounting Brackets for Above 35¢ Pair

A B CARBON RESISTORS

Brand New—Fresh Stock All Standard R.M.A. values available EB 1/2 GB 1 HB 2 Price Schedule

Watt	Tol.	1 to 99	of a value
1/4 Watt	10%	5.05 ea.	52.95
1/2 Watt	5%	10 ea.	6.00
1 Watt	10%	08 ea.	5.00
2 Watt	5%	16 ea.	11.00
2 Watt	10%	10 ea.	9.00
2 Watt	5%	20 ea.	18.00

TYPE "J" POTS

• JLU Locking Bushing • Shaft for Knob Your choice—95¢ ea.

OHMS	OHMS	OHMS	OHMS	OHMS
50	1K	4K	50K	500K
100	1500	5K	75K	1 MEG
250	2K	10K	100K	2 MEG
500	2500	15K	150K	2.5 MEG
	3K	25K	250K	5 MEG

COAX CONNECTORS

SPECIAL: SO 239 } 35¢ ea. Brand New
PL 259 }

83-1AC	5.42	83-22R	.68	UG-21B/U	51.00
-1AP	.30	-22SP	1.95	27P/U	2.35
-1B	.35	-22T	1.35	58A/U	.68
-1F	1.10	-168	.12	200/U	.85
-1H	.12	-185	.12	260/U	.75
-1HP	.22			260A/U	1.00
-1J	.70			260B/U	1.00
-1R	.35	M-358	1.30	261/U	.75
-1RTV	.65	M-359	.60	261A/U	1.00
-1SP	.35	M-35A	.60	261A/U	1.00
-1SPN	.35	PL-258	.75	262/U	.95
-1T	1.30	PL-259	.35	274/U	1.00
-22AP	1.40	PL-259A	1.10	290/U	1.00
-22F	2.10	PL-274	1.30	291/U	.60
-22J	1.40	SO-239	.15	291/U	.70

OIL CONDENSER SPECIALS

10 mfd.—600 v. \$89

Three term, bot. mtg. channel type. Dims. 3 3/4" x 2 1/2" x 2". Two 5 mfd. sections rated 400 V at 72 deg "C". 1800 V test. Meets commercial specs. for 600 V operation up to 40 degs "C". Ideal for filter or power factor application. Repeat sales prove this rugged high quality condenser to be of outstanding value. Carton of 24, weight 42 lbs. Large qua. available \$79

6 mfd.—150 v. \$29

Three term, dual 3 mfd. oil cond. complete with brackets, measuring 4 1/4" x 1 3/4" x 1". Ideal for audio crossover networks.

2 mfd.—7500 v. \$21.95
Pyranol-Ind. Cartoned

Mfd	Volts	Price	Mfd	Volts	Price	Mfd	Volts	Price
.001	50KV	24.94	5	25KV	45.95	5	1000	1.89
.0023	16KV	6.95	65	12.5KV	13.95	5	1500	1.98
.01	5000	.79	1	500	.55	2x5	400	.89
.01	10KV	4.95	1	1000	.69	2x5	600	1.19
.012	25KV	12.95	1	1500	.99	3x5	400	1.25
.02	10KV	4.75	1	2000	1.35	6	600	1.69
.02	10KV	5.25	1	2500	2.20	6	330AC	1.69
.02	20KV	10.95	1	3000	2.25	6	1000	2.30
.025	50KV	22.95	1	5000	6.25	6	1500	2.95
2x			1	6000	5.95	7	110AC	.79
.025	50KV	34.50	1	6000	6.50	7	600	.98
.03	75KV	4.50	1	7500	8.95	7	600	1.35
.035	10KV	4.95	1	7500	14.50	7	800	1.75
.05	7500	2.95	1	10KV	23.50	7	500	2.00
.08	12.5KV	8.95	1	15KV	26.95	7	800	29.95
.1	1500	.39	1	20KV	45.95	8	500	1.99
.1	2000	.45	1	25KV	49.50	8	600	1.49
.1	2000	.89	1	25KV	65.00	8	660AC	4.25
.1	2500	.98	1	25KV	75.00	8	800	1.89
.1	3000	.69	1.75	330AC	.69	8	1000	2.78
.1	3000	1.19	2	600	.55	8	1400	3.05
.1	7500	.85	2	600	.65	8	1500	3.65
.1	7500	4.25	2	1000	.79	9	2000	5.95
.1	10KV	6.35	2	1000FLA	1.25	8	2500	6.50
.1	12KV	6.95	2	1000FLA	1.45	8	600	1.89
2x.1	2000	.89	2	2000	2.80	10	50AC	1.65
2x.1	7000	3.50	2	2500	3.45	10	600	1.19
2x.1	6000	8.25	2	3000	4.25	10	600	2.25
2	10KV	8.25	2	4000	7.50	10	3000	3.75
2	15KV	13.90	2	5000	12.50	10	1500	4.25
2	50KV	39.50	2	6000	21.95	10	2000	5.95
3x.2	4000	2.85	2	10KV	35.95	12	660AC	3.75
2.5	1500	.88	2	12.5KV	59.50	14	50	.99
2.5	2000	.98	2	20KV	89.15	15	300AC	3.50
2.5	3000	1.38	2x2	600	.85	15	400	

SAVE ON TUBES BRAND NEW TUBES GUARANTEED TUBES

OA2 .75	2J55 .35	4X150A .22	F123A .29	WL456 .59	832 .37	5634 .75
OA3 1.00	2J56 .50	4X500A .55	F128A .15	464A .22	832A .50	5636 .40
OB2 .75	2J61 .15	5BP2A .50	HF100 .75	RH507 .25	833A .27	5637 .85
OB2WA 3.00	2J62 .50	5BP4 .20	FG154 .15	CK512AX .11	834 .30	5651 .14
OC3/VR105 .75	2J62A .50	5CP1 .17	VT158 .97	527 .15	836 .15	5654 .15
OD3/VR105 .75	2JB51 .35	5CP1A .95	FG166 .15	ML531 .40	837 .10	5656 .70
1B23 3.00	2K22 .14	5C22 .29	FG172 .15	559 .50	838 .75	5657 .125
1B24 5.50	2K25 .90	5C30/C5B .15	WL200 .75	KU610 .35	838W .30	5663 .15
1B24A 15.00	2K26 .45	5CP7A .10	203A .50	HY615 .50	842 .25	5667 .125
1B26 2.00	2K28 .35	5D23 .75	204A .35	WL616 .99	845 .50	5670 .20
1B27 10.00	2K33A .60	5FP7 .15	207 .50	KU627 .10	849 .20	5672 .125
1B35 4.50	2K34 .99	5FP14 .50	211/VT4C .50	KU628 .10	851 .10	CK5678 .10
1B36 4.00	2K39 .100	5JP2 .70	212E .17	648P1 .75	852 .50	5686 .20
1B40 2.50	2K41 .100	5JP4 .70	217A .15	HK654 .25	860 .30	5687 .30
1B51 6.75	2K43 .125	5JP5 .70	217C .20	WL652 .20	861 .15	5691 .47
1B63A 22.00	2K44 .125	5JP11A .12	WL218 .25	WE701A .18	865 .50	5692 .50
1N21 .75	2K45 .45	5J23 .20	QK221 .125	706AY-GY .15	866A .11	5693 .47
1N21B 1.50	2K47 .125	5J26 .90	FG235A .25	WE703A .12	872A .13	5696 .10
1N22 .75	2K48 .80	5J29 .50	QK249 .150	WE704A .75	874 .60	5702 .20
1N23 .75	2K54 .15	5J30 .50	WE249B .25	WE705A .75	878 .50	5702WA .60
1N23B 1.50	2K56 .50	5J33 .50	WE249C .30	706AY-GY .15	884 .10	5703 .11
1N23BM 3.50	2V3G .15	5MP1 .39	250TL .15	707A .35	GL889 .60	5718 .30
1N25 4.00	2X2A .10	5NP1 .50	251A .47	707B .45	GL889A .74	5719 .25
1N26 4.50	3AP1 .45	5R4GY .10	WE252A .10	WE708A .75	889A .125	RK5721 .175
1N28 5.00	3BP1 .20	5R4WGY .24	QK253 .149	713A .50	902A .30	5725 .18
1N34A .50	3B22 .15	C6J .65	WE254A .50	714A .12	902P1 .30	5726 .75
1N35 1.50	3B24 .10	6AC7A .90	FG258A .100	715A .20	919 .22	5727 .22
1N42 8.00	3B24W .50	6AC7W .12	271A .10	715B .47	922 .12	5744 .10
1N47 3.00	3B26 .30	6AJ5-JAN .12	WE274B .10	715C .12	927 .10	5750 .31
1N63/K63 .17	3B28 .60	6AK5W .15	WE282B .50	717A .50	SN930 .45	5751 .22
1N69 .40	3B29 .60	6AR6 .13	QK283A .100	719A .95	931A .25	5780 .19
1P21 22.50	3C22 .60	6AS7G .25	QK284A .100	720AY-EY .50	935 .40	CK5787 .49
1P22 6.50	3C23 .50	6D21 .200	WE287A .35	721A .75	954 .35	5814 .15
1P28 9.00	3C24 .15	6F4 .32	WE300B .50	721B .72	955 .35	5814A .22
1P29 2.00	3C27 .15	6J4 .30	304TH .89	722A .35	956 .35	5819 .37
1P36 2.50	3C31 .15	6K4 .22	304TL .89	723A/B .85	957 .35	5825 .79
1P39 1.20	3C33 .99	6L6WGB .35	WE305A .30	724A .10	958A .35	5829 .20
1W5 1.25	3C45 .70	6SK7W .20	307A/RK75 .10	WE724A .85	959 .15	5837 .95
2AP1 5.00	3DP11A .75	6SL7WGT .20	WE308B .10	724B .75	991 .35	5840 .50
2C26A .50	3D21A .35	6SN7W .20	WE312A .29	WE724B .85	CK1005 .35	5842 .13
2C34 .35	4EC3J .70	6SU7GT .22	WE313C .30	725A .32	CK1006 .27	5844 .30
2C35 2.50	3DP1S2 .50	6X5WGT .13	WE316A .50	726A .70	CK1007 .75	5851 .40
2C39 7.50	3E29 .85	7C22 .50	327A .25	726B .30	1603 .30	5896 .65
2C39A 8.00	3FP7A .35	7C23 .69	WE336A .50	726C .20	1620 y .32	5899 .70
2C40 7.50	3CP1 .19	7C24 .95	WE338A .50	730A .75	1623 .23	5901 .65
2C42 10.00	3J30 .35	15E .10	WE349A .75	750TL .42	1624 .10	5905 .89
2C43 7.00	3J31 .45	NE16 .35	WE350A .27	800 .15	1625 .30	5907 .79
2C44 .50	3K30 .125	FG17 .29	350B .27	801A .50	1626 .35	5908 .79
2C46 9.00	4B23 .75	RK21 .10	354C .50	802 .27	1630 .50	5910 .45
2C51 3.00	4B24 .75	RX21 .55	WE359A .20	803 .14	1631 .17	5932 .40
2C52 3.50	4B26 .35	HK24 .30	368AS .25	804 .97	1636 .12	5933/807W .40
2C53 10.00	4C27 .35	D42 .40	371B .50	805 .45	1641 .15	5965 .15
2D21 .75	4E27 .87	HK54 .20	WE388A .12	806 .75	1642 .50	5998 .15
2D21W 1.50	4C28 .25	QK59 .30	WE393A .45	807 .12	1945 .65	6021 .50
2E26 3.25	4C35 .13	QK60 .25	WE394A .30	807W .40	2050 .10	CK6050 .20
2E27 .75	4J22 .35	RK60/1641 .15	WE396A .30	808 .12	2051 .65	6112 .70
2E32 1.00	4J28 .35	QK61 .25	403B/5591 .27	809 .25	ZB3200 .75	6147 .40
2J31 14.50	4J29 .35	QK62 .25	GL414 .99	811 .29	5551 .25	6177 .49
2J32 14.50	4J31 .65	HY65 .20	417A .35	812 .25	5553/655 .100	8005 .49
2J33 14.50	4J34 .50	RK65/5D23 .10	WE418A .15	813 .11	5557/FG17 .29	8012 .10
2J34 14.50	4J42 .25	FG67/5728 .10	WE422A .11	814 .17	5559/FG57 .12	8013 .49
2J36 20.00	4J50 .99	RKR72 .50	RT434 .25	815 .15	5560 .20	8025A .20
2J39 10.00	4J52 .50	RKR73 .50	434A .30	816 .15	5561 .29	9001 .85
2J40 14.50	4J57 .100	100TH .65	446A .50	829 .60	5586 .150	9002 .65
2J42 60.00	4J58 .100	FG104 .29	446B .20	829B .85	5591/403B .27	9004 .85
2J48 35.00	4X150G .35	FG105 .11	450TH .35	830B .75	5611 .99	9005 .15
2J49 40.00			450TL .35			9006 .25
2J50 35.00						

THIS IS ONLY A PARTIAL INVENTORY. CHECK WITH US FOR YOUR REQUIREMENTS

Thousands of other types in stock. Send us your requirements. RECEIVING TUBES! We Carry a complete line in stock. Standard brands only.



ELECTRONICS
Dept. EV
1108 Venice Blvd.
Los Angeles 15
California

All Prices F.O.B. Los Angeles, subject to change without notice. Minimum order \$5.00. Check with us for items not listed.

COMMUNICATIONS EQUIPMENT CO.

MICROWAVE MAGNETRONS

*2J21A	\$2.25	3J31	\$32.50	700B	\$8.75
2J22	2.50	4J34	23.50	700D	8.75
2J26	2.50	4J42	47.50	796A	9.75
2J27	3.00	5J23	34.50	796D	14.75
2J29	1.50	5J30	14.50	798CY	9.75
2J31	13.95	5J33	4.75	706EY	9.75
2J32	14.50	QK 59	39.50	725A*	
2J37	9.50	QK 60	35.00	730A	8.75
2J39	8.25	QK 61	50.00		
2J62	6.75	QK 62	54.00		

* Write

X BAND - 1" x 7/8" WAVEGUIDE



AT-68/UP 3 Cm Horn with type N feed for receiver measurements, etc. New (as shown) \$7.45

- ROTARY JOINT (APS-6) Sperry PT #658275, 180 deg. rotation, choke-to-choke. Has "Built-in" Di-Coupler, 20 DB., with "N" Takeoff \$22.50
- PARABOLOID DISH 18" diam. Spun Aluminum \$4.95
- Focus For AN/APS-6
- 3 CM. DIPOLE and Feed Assembly. (May be used with above dish.) 8 inches long \$5.00
- FLEXIBLE SECTION 3 in. long Cover-to-Cover. \$5.50
- 3CM. DIPOLE FEED, 15" L. for AN-15 10 1/2" Focus \$14.50
- MITRED ELBOW. Cast aluminum, 1/4" x 5/8" W x H. W.E. Flanges "E" Plane \$3.50
- 3 CM. ANTENNA ASSEMBLY: Uses 17" paraboloid dish, operating from 24 vdc motor. Beam pattern: 5 deg. in both Azimuth and elevation. Sector Scan: over 160 deg. at 35 scans per minute. Elevation Scan: over 2 deg. (Over 24 deg. with "N" Takeoff) \$35.00
- Cross-Guide Directional Coupler, UG-40 output flange. Main Guide is 6" Long, with 90 Deg. "E" Plane bend at one end, and is fitted with Std. UG 39/UG 40 flanges. Coupling figure: 20 db Nominal. \$22.50
- RG52/U Waveguide in 5' lengths, fitted with UG 39 flanges to UG40. Silver plated. per length \$5.00
- Rotating Joints supplied either with or without deck mounting. With UG40 flanges each \$17.50
- Bulkhead Feed-thru Assembly \$15.00
- Pressure Gauge Section with 15 lb. gauge \$10.00
- Directional Coupler, UG-40/1" Take off 20db. \$17.50
- MAGNET AND STABILIZER CAVITY For 2J41 Magnetron \$24.50
- 90 degree elbows, "E" plane 2 1/2" radius \$8.50
- ADAPTER, waveguide to type "N", UG 81-U, p/o TS 12, TS-13, Etc. \$7.50
- ADAPTER, UG-163/U round cover to special BTL Flange for TS-45, etc. \$2.50 ea.

I. F. AMPLIFIER STRIPS

Model 15: 30 Mc Center frequency. Bandwidth 2.5 Mc gain figure: 65 db. Uses 5 stages of 6AC7's. Has D. C. Restorer and Video Detector A.F.C. Strip included. Input impedance: 50 Ohms. Less tubes \$17.50

60 MC. Miniature IF strip, using 6AK5's 60 Mc center Freq. Gain: 95 db at Bandwidth of 2.7 Mc. New. Complete with tubes \$15.00

JAN WAVEGUIDE FLANGES

UG 39/U	\$1.10	UG 51/U	\$1.65
UG 40/U	\$1.25	UG 52/U	\$3.40
UG 40A/U	\$1.85	UG 52A/U	\$3.40

COAXIAL R.F. FILTERS

- F-29/SPR-2, Hi-Pass, with 1000 mc Cut-off, Type "N" input and output. 50 Ohms Z \$9.50
- F-41/SPR-1, Hi-Pass, with 300 mc cut-off, Type "N" input and output. 50 Ohms Z (As shown) \$10.50



PULSE TRANSFORMERS

- 4P37 Primary, 50 Ohms 750V. .001 Duty. Sec. 15KV. 1000 Ohms Impedance. Bifilar 12.6V/2.5A. \$32.50
- RAYTHEON WX 4298E Primary 4KV., 1.0 USEC. SPC. 10KV/16 AMV DUTY RATIO: 001 400 CYCLES
- WEL TRANS. "BUILT-IN" \$42.50
- WECO: D-163247 For Modulator of SCR 720. \$22.50
- GE #K-2449A, Primary: 9.33 KV, 50 ohms Imp. Secondary: 28 KV, 450 ohms. Pulse length: 1.05/5 usec @ 635/120 PPS, PK Power Out: 1.740 KV. Bifilar: 3.5 amps (as shown) \$62.50
- GE #K-2748-A, 0.5 usec @ 2000 PPS. PK Pwr. out is 32 KW impedance 40-100 ohm output. Pri. volts 2.3 KV 1% Sec. volts 11.5 KV PK. Bifilar rated at 1.3 Amp. Fitted with magnetron well. \$24.50
- K-2745 Primary: 3.1/2.8 KV, 50 ohms Z. Secondary: 14/12.6 KV 1025 ohms Z. Pulse Length: 0.25/1.0 usec @ 600/600 PPS. PK. Power 200/150 KV. Bifilar: 1.3 Amp. Has "built-in" magnetron well. \$32.50
- K-2461-A, Primary: 3.1/2.6 KV—50 ohms (line). Secondary 14/11.5 KV—1000 ohms Z. Pulse Length: 1 usec @ 600 PPS. PK. Power Out: 200/130 KV. Bifilar 1.3 Amp. Fitted with magnetron well. \$29.50
- K35145—Pulse Inversion: PRI: 5 KV PK. Pulse Negative. Sec: Pos. Pulse, 4 KV: 1 usec. and .001 DUTY RATIO \$6.50
- 54J318-1—3 wdg. Ratio: 1:1:1, 1.10 uh. /wdg. 2.5 ohms DCR \$3.50

PULSE MODULATORS

- MIT. MOD. 3 HARD TUBE PULSER: Output Pulse Power 144 KW (12 KV at 12 Amp.) Duty Ratio: .001 max. Pulse duration: 0.1, 1.0, 2.0 microsec. Input voltage: 115 v. 400 to 2400 cps. Uses 715B 1-829R 3-72's, 1-73. New. Less Cover—\$135
- ASD Modulator-Units. mfd. by Sperry. Hard tubes pulser delivers PK. pulse of 144 kw. Similar to Mod 3 unit. Brand new, less tubes. \$85.00

Airborne RF head, model ASD, delivers 50 Kw peak output at 9000 mc. at .001 duty. 1 usec./1000 PPS. Complete with pulser unit and all tubes. \$210

3 CM. TEST SETS

- TS 12/AP. For standing wave measurement of plumbing, TR/ATR boxes, crystal mixers, antennas, etc. The TS 12 consists of two basic units. Unit 1 is a high gain stable amplifier followed by a 3-inch meter which reads SWR directly. UNIT 2 consists of waveguide accessories, including a slotted line, probes, dummy load, adapters, etc. Either bolometer or crystal input may be used. Both units are portable, self contained. Operates from 115 v. 60-800 cps. New! \$13/AP. Signal source 9305-9445 mc. 50 microwatts. Comes with a wavemeter, thermistor-bridge power meter, and calibrated attenuator. Oscillator is a klystron type 723/a-b which may be internally (self-synch) or externally pulsed. Controls are provided for FM operation, variable pulse delay, pulse width and phasing. Operates from 115 v., 60-800 cps. New! Price on Request

- IN STOCK -

AIA	ASH	SO-8
APA-9	BG	SJ-1
APA-10	DAS†	SG-1
APN-3	DBS†	TAJ
APN-7	APT-2	TBK
APN-9*	APT-4	TBL
APS-2	MKIV	SCR520*
APS-3	MKX	SCR521
APS-4	RC145	SCR518
APS-6	RC148	SCR545
ASD	SO-1	SCR584

* COMPONENTS. † LORAN EQUIPMENT

- TEST SETS -

TS-10	TS-12	TS-159
TS-36	TS-56	TS-90
TS-47	TS-34	TS-98

BARGAIN SPECIALS

- Barry shock mounts: nos. 2045, C-2060, C-2070, C-2080 \$3.00
- Trihedral radar reflector, MK-1 aluminum, 45x6x6 \$3.50
- SPLICER, for 1/16 perforator tape, W300 = X-61850 list 20 SCS = 41W 61850-20. Complete set, with number tape dispenser \$8.50

SPARES FOR PRC-10

3C1084H-67	3C1084H-71	2Z5822-488
3C1084H-68	3C1084Z-74-3	2Z5822-503
3C1084H-69	2Z9632.611	3DA1-304
	2Z9631.407	3DA10-543

- MN 28Y Control box, unit of MN 26 compass, New \$3.75
- Noise filters, Mallory NPL-1, 100 amp/35 vdc. \$1.00
- Power supply unit, navy type-EL-2, Input: 115 vac, 60 cy. Output: 135 vdc/10 ma. 90 vdc/5ma; 3 vdc/360 ma. New, complete with spare parts box. To be used with model TBX radio gear \$9.50
- Coaxial switch, 12 position, with type "N" fittings. Type SA-14 SPR-1 \$17.50
- Amplifier, Altec A-127, 18 Watts output with response from 20-20,000 cps. Operates from 115 v. 60 cps. Std. rack panel intg. Used, excellent. \$103
- Pulse analyzer, type AFA-6. With 3 in. scope. \$235
- BC 602 Control box for SCR 522 (pushbutton). \$3.75
- 24-volt Transformer. Input 115 v/60 cy. Output 24 v/3A \$1.79
- Phase-shifter, Helmholtz type: 0-360 deg. \$2.50
- Capacitor, oil-filled, 0.25 mfd., 25,000 volts dc. \$15
- Hydrophone, MODEL M1-2. A lattice of 3 crystals in a disk like structure, 17-37 Kc. \$27.50
- AN/CRW-2A Remote control receiver, for operating target planes, etc. New, with soundproof mounting box \$34.50
- TEL. REPEATER, EE 89, complete with tubes and tech manual \$17.50
- TEL. REPEATER, EE 99, with 12 vdc. vibrator power supply (P/S 204) \$49.50
- F.T.&R. 101-A. Two-wire applique, contains equalizing devices, and balancing circuits. Used for adapting 2-wire military circuits to 4-wire systems. \$47.50
- RADAR TRAINER, Model 15-C. Brand new, complete with pulse generator, power supply, main unit, all cables and instruction book. \$125
- UNDERWATER MICROPHONES, Model JH—Consists of a mosaic of 7 crystals. May be used at 17-73 Kc. omnidirectional, 50 ohm output. \$27.50
- SA1A/APA-1 Motor Driven Coaxial Ant. Switch DPDT. Continuous Operation from 21VDC. Completely Enclosed \$34.60
- MP-22 MAS BASE Mobile Antenna Mount \$4.59
- SA-A/APN-1 Altitude Limit Switch for APN-1 Altimeter \$7.95
- ALTITUDE INDICATOR for APN-1 \$12.50
- C-87D Final P.A. Coil for BC610 2-3.5 MC. Variable Link \$4.89
- RA-74 Power Supply for Super Pro. \$69.50

ELECTRIC MEGAPHONE SYSTEM

For Rural Areas, Hotels, Commercial Steamers, Ball Parks, Etc.

U. S. NAVY type PAE-1 Electric Megaphone equipment is designed for voice reinforcement in much the same manner as, but to a greater degree than, the familiar acoustic megaphone. Consists of Megaphone Unit (which combines a microphone and reproducer in a single assembly). Portable Amplifier which electrically amplifies the output signal of the microphone section of the megaphone and feeds this amplified signal to the reproducer section. Charging Rack for recharging the self-contained storage battery of the portable amplifier. BRAND \$129.50 NEW



DYNAMOTORS

TYPE	VOLTS	INPUT AMPS	OUTPUT VOLTS	OUTPUT AMPS	Price
BDAR83	14		375	.150	\$6.50
35X-059	19	3.8	405	.095	4.35
POSX-15	14	2.8	220	.08	8.95
DM33A	28	7	540	.250	3.95
23350	27	1.75	285	.075	3.95
B-19	12	9.4	275	.110	6.95
DA-3A*	28	10	300	.260	3.95
			150	.010	
			14.5	5.	
PE 73CM	28	19	1000	.350	10.50
ED 69†	14	2.8	220	.08	8.95
DAG-33A	18	3.2	450	.06	2.50
DM25†	12	2.3	250	.05	6.95
BDAR 93	28	3.25	375	.150	6.95

† Less filter
* Used, Excellent.
‡ Replacement for PE 94.

INVERTERS

- 800-1B Input 24 vdc, 62 A. Output: 115 V., 800 cy. 7A. phase. Used, excellent. \$18.75
- PE-218H: Input: 25/28 vdc. 92 amp Output 115V/3000 500 cy 1500 Volt-ampere. New. \$32.50
- PE206: Input: 28 vdc. 36 amps. Output: 80 V 800 cy. 500 volt-amp. Dim. 13 x 5 1/2 x 10 1/2. New. \$22.50
- AN3187-1, Input: 13.75 V; 18.4A. Output: 115 V/4000 3 1/2. 0.95 PF. New. \$59
- FU 7/AP. Input: 28 vdc/160 A. Output: 115 VAC, 400-1 1/2. 500 VA, 21.6 Amp. Volt. and Freq. Reg. Used, Exec. \$75

TS-56A/AP TEST EQUIPMENT

Slotted line test equipment designed for operation over a frequency of 500-675 MC. Has impedance of 51 ohms. Ideal test set for matching antennas, measurement of characteristics of transmission line. With instructions manual. New. Shipping \$12000 wt.: 41 lbs.

TEST OSCILLATOR TS-47/APR. 40-2000 + Mc. Fundamental coverage 40-500 Mc in two ranges. Harmonics above 2000 Mc. Provides a calibrated (dial) accuracy ± 0.7 per cent. HF source for testing receiving equipment. Output 330V or more up to 400 Mc. Less on harmonics. C.W., mod. pulse or sine wave output. Operates on 115/230 60 Cy. or batteries Part of ATR countermeasures equip— \$16500 ment. New

VHF ANTENNA



Sig. Corps. AN154. 150-200 mc. Consists of 3 vertical dipoles working in g against a mesh reflector, 80 in. x 40 in. Spacing between elements is 1/2 wavelength. Unit comes complete with portable carrying chest and 1/12 antenna folds up to 46 in. x 18 in. height. \$22.50 (Hpp. wt. approx. 200g (as shown))

400 CYCLE TRANSFORMERS

Model	Primary	Secondary	Price
KS13101	(All Primaries 115V. 400 Cycles) 6.3V/15A, 6.3V/0.9A, 6.3V/0.4A, 6.3V/0.2A		\$3.85
KS13104	1450VCT/0.283A, 1050VCT/0.217A		7.50
KS9815	6.3V/4A, 3V/1A		1.57
KS9608	123V/35MA, 1140VCT/0.7A		5.79
302433A	6.3V/9.1A, 6.3VCT 6.5A, 2.5V/3.5A, 2.5/3.5A		4.85
KS 9445	592VCT/118MA, 6.3V/8.1A, 5V/2A		5.39
KS 9685	6.4V/7.5A, 6.4V/8A, 6.4V/2.5A		4.75
	ALL CT		
70G30G1	600VCT/36MA		2.69
M-7474318	2100V/0.27A		4.95
352-7069	2-2.5V Wdgs at 2.5A, Each Lo-Cap. 22K Test		5.95
352-7096	1.2A, D/O BC800		4.95
352-7099	360VCT/20MA, 1500V/1MA, 2.5V/1.75A, 6.3V/2.5A, 6.3V/6A, P/O BC-929		6.45
D1 63253	5200V/0.02A, 2.5V/5A		5.35
M-7471957	2.5V/20A, 12KV Test		4.85
352-7179	250V/100MA, 6.5V/12ACT, 5V/2A		3.45

MAIL ORDERS PROMPTLY FILLED. ALL PRICES F.O.B. NEW YORK CITY. M.O. OR CHECK. ONLY SHIPPING SENT G.O.D. RATED CONCERNS SEND P. O. PARCELS IN EXCESS OF 20 POUNDS WILL BE SHIPPED VIA CHEAPEST TRUCK OR RAILEX.

131 Liberty St., New York 7, N. Y. Dept E-11 Chas. Rosen Phone: Dlgy 9-4124

SEARCHLIGHT SECTION

WANTED
BC-788, T-47A/ART-13,
BC-348R, R-5/ARN-7,
RT-18/ARC-1

AN/ASQ-1 and 1A MAGNETOMETERS
 This is an airborne magnetometer used to measure the magnetic flux of the earth and to locate submarines and other metallic objects by their distortion of the magnetic field. Sensitivity 2.3 gamma or better. POR.

AN/GSQ1-A SPEECH SCRAMBLERS
 Speech scrambler for use on any comm. channel to insure privacy. We can supply complete installations of this equipment 28v DC input. Also 110v 60 cyc.

SCR-291A DIRECTION FINDER
 Automatic ground direction finder covering 1.5mc-30mc. Provides instant bearings on a C.R. indicator of any signal in its range. This equipment is transportable and can be set up quickly. 110v 60 cyc. POR.

P.P.I. REMOTE RADAR REPEATERS

We can supply the following types of remote Radar P.P.I. Repeaters. The main radar provides the Synchronizing, Syncro, and Video. Pulses to operate the Repeaters. These repeaters may be used with any marine ground-airborne.

VC 7" P.P.I. Upright deck mount Repeater. 4 Ranges are provided from 4-200 miles. Input 110 Volt 60 Cyc.

VD 7" P.P.I. Deck mount Repeater. This unit is very similar to the VC but is completely Waterproof and may be used on deck. The ranges are the same as the VC. Input 110 Volt 60 Cyc.

VE 7" P.P.I. Table mount Repeater. This is a very compact set. 4 ranges are provided from 4-200 miles. Input 110 Volt 60 Cyc.

VF 9" P.P.I. Deck mount Repeater. This is a very late model Repeater enabling 20 radars to be fed into it. 4 Ranges from 4-200 miles are provided. Input 110 Volt 60 Cyc.

VG 12" P.P.I. Plotting Table Projection Repeater. This is a very elaborate Remote Indicator. For use in a plotting center. Up to 20 Radars may be fed into it. This set utilizes a Skiatron tube to provide data that can be retained on the screen and can be erased at will. Input 110 volt 60 Cyc.

Accessories are available such as repeater adaptors enabling the set to be used at a greater distance than normal. Input switches to select the radar to be viewed etc.

RADALAB
 87-17 124th STREET
 Richmond Hill 18, New York
 Phone Virginia 9-8181-2-3

SCR-682-A RADAR
 10CM high power long range harbor surveillance and early warning RADAR. This equipment is a 3000 mc mobile search radar that can be transported in a truck. The equipment incorporates a 7" PPI for operation up to 240,000 yards. Azimuth accuracy is ± 1%. Range accuracy is 100 yards at 10,000 yard range and 5000 yards at 240,000 yard range. Trans. output is approx. 225 KW. pulse width is one microsecond. Antenna beam width is 8°. Input is 110v 60 cyc. Can be supplied with or without operating shelter or antenna tower. POR.

We can supply many types of radars, test sets, communications equipments, manufactured after 1947. Write us if you cannot find it.

AN/APR-4 38-4000 MC RECEIVER
 This is a precision receiver covering 38-4000 mc. The set utilizes 5 tuning units with direct reading dials in megacycles. The receiver has a wide and narrow band width 30mc. I.F. strip which may be selected at will. An output meter is provided to measure signal strength. Outputs are provided for a pulse analyzer and pen adaptor. Each tuning unit has an automatic sweeping mechanism which enables any portion of the tuning range to be scanned automatically. Input 110v 60 cyc. POR.

500-1300 MC SIGNAL GENERATOR
 This is a high precision signal generator covering 500-1300 mc. A precision attenuator is built in providing accurate determination of output, from 0-100,000 microvolts. Either CW or pulsed carrier output with the following characteristics are provided. Pulse rate 60-2,500 CPS. Pulse length 2-30 microseconds. Output line 50 Ohm impedance. Accuracy better than one percent. Input 110 v 60 cyc. With calibration charts. Price \$249.50

90-600 MC SIGNAL GENERATOR
 This set covers 90-600 mc. with an accuracy of one percent or better. C.W. or pulse output with the following characteristics are provided. Output from 0-100,000 microvolts 2-30 microseconds long. Pulse rate 60-2500 cyc. Pulse delay 3-300 microseconds. Output 50 ohm line. Input 110v 60 cyc. Price.....\$249.50

Prices FOB NYC. Rated firms open account. Prices subject to change without notice.
CABLE: Radalab, NY
TELETYPE: NY-4-4361

CF-3A CARRIER REPEATER
 This is a transportable 4 wire carrier telephone repeater. This set amplifies all signals when used in an intermediate position on a carrier system to extend the range. DC signaling and telegraph communications can be performed to the terminal equipments or to other repeaters. Monitoring and transmission circuits are built in. Power Input 110 or 220v or 12v DC. This set can be used with all CF terminals and commercial equipments. Brand New in original cases. POR.

AN/APA-17 DIRECTION FINDER
 This is an automatic direction finder covering 300-1,000 mc to be used with the APR-1 and APR-4 radar search receivers. The bearing is presented on a cathode ray screen in a cardoid pattern. The set can be used in aircraft or on the ground. Input 110v 400 cyc and 28v DC. POR.

RADAR BEACONS
X and S Band High and Low Power Racons

We can supply the following Beacons in Portable and Stationary Models. The X-BAND models will operate with the new Weather Radar AN/CNP-6 X-Band high power Radar Beacon. This is a 40 KW set for use at an Airport. This set will interrogate X-BAND Radars up to 200 miles. Variable Coding is provided as well as monitoring facilities. Input is 110 V 60 CYC.

AN/CNP-8 S-BAND HIGH POWER Airport Beacon. This is a very compact set. This set will interrogate S-BAND Radars up to 200 Miles. Variable Coding and monitoring facilities are provided. Input 110 Volt 60 Cyc.

AN/CNP-17 S-BAND High power version of the CPN-6 with all the latest improvements. Input 110 Volt 60 Cyc.

AN/UPN-4 X-BAND Very lightweight Portable Beacon. This set will interrogate X-BAND Radars up to 60 miles. Variable Coding is provided. Input 12 Volts D.C. and 110 Volts 60 Cyc. Weight Approx 50 Lbs.

AN/UPN-1 and 2 S-BAND Portable beacons. This set will interrogate a S-BAND Radar up to 60 Miles. Variable Coding is provided. Input is 12 Volts D.C. and 110 Volts 60 Cyc. Weight Approx 50 Lbs.

MOTORS:

24 **VDC REVERSIBLE MOTOR** — 3.7 RPM, 40 lb. Torque. Motor size: 5-1/2" x 4-1/32" x 3-5/16". Shaft size: 21/32" x 5/16". Also operates 24 VAC. Philco No. 441-1008. Price: \$5.95

27.5 **VDC**—6000 RPM, 1.5 oz. In Shaft Size: 1/2" x 3/4". Motor size: 2 1/4" x 1 1/4". No. 5069-267. Price: \$4.95

26 **VOLT 60 CYCLE**—60 RPM Synchronous Cramer Motor #1147. Shaft size: 1" x 3/4". Price: \$1.95

110 **VDC 1/70 HP.** 1550 RPM. Motor size: 4" x 2 1/4". Shaft size: 1" x 3/16". Redmond #137. Price: \$4.95

6 **VDC 1/20 HP.** 4000 RPM. Motor size: 3" x 3". Shaft size: 3/4" x 1/2". Redmond #P-50. Price: \$4.95

12 **VDC 1/30 HP.** 4500 RPM. Motor size: 3" x 2 1/4". Shaft size: 1" x 3/16". Delco #5047520. Price: \$4.95

27 **VDC 1/10 HP.** 3500 RPM. Shaft size: 5/8" x 3/4". Motor size: 4"x3-1/2". Air Assoc. No. EP 763. Price: \$6.95

80 **VDC 1/50 HP.** 3000 RPM. Shaft size: 3/8" x 1/2". Motor size: 6" x 3". G.E. #5 PN33H1A10. Price: \$8.95

28.5 **VDC 1/35 HP.** 2200 RPM. Shaft size: 1 1/2" x 1/2". Motor size: 4 1/2" x 3 1/4". Electrolux #16876. Price: \$5.95

27 **VDC GEAR HEAD MOTOR**—960 RPM; 1/75 HP; 1.75 A. Size: 5" x 3". Shaft 3/4" x 5/8". Air Assoc. #EE120M1. Price: \$7.95

27.5 **VDC GEAR HEAD MOTOR**—32-1/2 RPM; 4050 RPM; Right Angle Drive Motor. Size: 5" x 3-1/2". Shaft: 5/16" x 3/4". Bodine Type #V10R. Price \$7.95

24 **V. GENEVA LOC ACTUATOR MOTOR ASSY.**—1/25 HP; 15000 RPM, w/Gear Head & Limitwitches. Motor Size: 5-1/2" x 3-1/4". Angle Drive Shaft: 1/2" x 1/4". Bendix #1M-100821. Price: \$7.95

24 **VDC GEARED HEAD MOTOR**—Heavy Duty, 8 Amp, 2-1/2 lb. Torque, 100/200 RPM. Shaft Size: 5/16" x 1". Right Angle Drive. Price: \$8.95

27 **VDC MOTOR**—1.5 A.; 1/50 HP.; 3000 RPM Shunt Motor; Motor Size: 3" x 2-1/4". Shaft: 5/16" x 3/4". Oster #DS-1 or WEYS-5876. Price: \$2.95

27.5 **VDC MOTOR**—1/100 HP.; 7000 RPM; Motor Size: 3" x 1-1/4"; Shaft: 1/2" x 3/4". L. Oster #C21B1-1A—Price: \$2.95

27.5 **PERMANENT MAGNET ALNICO FIELD MOTOR**—03 Amp.; 10000 RPM; Size: 1" x 1-1/4" x 2". Shaft: 5/8" x 1/2". Delco #5068571. Price: \$7.95

INVERTERS & GENERATORS:

AC-DC GENERATOR—Output 115 VAC 800 cycle 10.5 A. & 28.5 VDC; 60 A. at 2400 RPM. 3/4" spline shaft. Bendix Eclipse No. NEA-3. Price: \$18.95

PE-21—Input 28 VDC; 100 A.; output 115 V. 400 cycle 1 phase, 1500 VA. Used: \$14.95—New: \$39.95

NEW ITEM 60 CYCLE TO 400 CYCLE MOTOR —

GENERATOR: Motor 3 HP, 115/230 60 cycle single phase; Generator 115 Volt 400 cycle single phase 1400 Watt & 28.5 VDC 400 Watt. Belt Drive. Reconditioned \$295.00

TYPE 800-1-D—Input 28 Volt 62 A.; output 115 Volt 7 Amp. 1 Phase 800 cycle. Price: NEW: \$24.95

METERS:

WESTON AC AMMETER:
 (Pictured) In portable leather case, with Test Leads, 2 1/2" x 0-15. Price: \$5.95

AC and 0-3 AG Scale.

DC AMMETER HOYT: In portable metal case with Test Leads. 4 1/2" Fan Mirrored scale 0-15 ADC. Price: \$4.95

0-3 **RF AMMETER** IS-125; 2 1/2" Rd. Price: \$2.95

0-8 **AMP RF w/Thermocouple** IS-89; 2 1/2" Rd. Price: 4.95

0-15 **AC DC**—2 1/2" Rd., IS-122. Price: 4.95

0-500 **MA DC**—2 1/2" Rd., IS-22. Price: 4.95

0-1 **MA DC** Simpson—3 1/2" Rd. Price: 3.95

0-2 **MA DC** Westinghouse—3 1/2" Rd. Price: 2.95

0-20 **MA DC** Westinghouse—3 1/2" Rd. Price: 2.95

0-150 **V. 60 cycle**—Simpson—3 1/2" Rd. Price: 3.95

0-250 **MA DC**—Delur—3" Sq. Price: 3.95

AUDIO OUTPUT METER—Portable, Five Ranges: 0-1.5, 0-15, 0-150 Volts AC. Res.—4000 Ohms. Plastic Case 1 1/2" x 5/8" Test. Price: NEW: \$6.95

Receiver—Transmitter
F M 20—28 M C.

BC-500 RECEIVER—TRANSMITTER: FM Crystal Control on 5 Channels, 10% Separation 20-28 MC.

TRANSMITTER: 25 Watt output. 7 tubes: 1/162S, 1/12A6, 3/12S7, & 2/12A7.

RECEIVER: 11 Tubes: 1/12S7L, 2/12A6, 3/12S7, 3/12H6, 2/12U8, & 1/12S7J.

DYNAMOTOR SUPPLY: Receiver 28 VDC 1.2 A. input; output 250 VDC 60 MA. Transmitter 28 VDC 4.1 A. input; output 550 V. 120 MA.

CONTROL PANEL: For Local Control and outlets for Remote also. Heavy duty 5" speaker. Size: 12" x 25" x 9 1/2". Weight: 65 lbs. Price: NEW: \$59.50

BRAND NEW GUARANTEED
SAVINGS FROM 70-85%

POWER RHEOSTATS
 "Be Right with" Famous Make

MODELS H-J-G-K-L-N-P-R

Ohm	Watt	Each	Ohm	Watt	Each	Ohm	Watt	Each
1	150(L)	5.54	25	25(H)	1.86	500	75(G)	3.15
2.5	50	3.79	75	100	3.66	150	100(K)	3.15
5	100(K)	3.79	25	100(K)	3.15	500	150(L)	5.05
7.5	150(L)	5.34	25	100(K)	3.25	500	150	4.25
10	100(L)	5.34	75	100(K)	3.55	500	300(N)	8.42
1	25	1.75	50	25	1.49	585	150(L)	5.05
1	50	1.98	50	25(H)	1.86	750	25	1.49
1.1	50	1.98	50	25	1.49	750	150	4.25
2	25	1.75	25	1.49	780	100(K)	3.55	
2	25(H)	1.86	75	25(H)	1.86	800	25	1.49
2	50	2.10	75	50	1.86	858	100	3.71
2.5	100(K)	3.79	75(G)	3.15	1000	50(J)	2.22	
3	150	4.18	300	500(R)	12.18	1000	50(J)	2.22
3	50(J)	1.56	100	25	1.49	1200	225(P)	9.99
3	100(K)	3.79	100	50	1.86	1250	50(J)	2.22
5	100(K)	3.79	100	50	1.86	1250	50(J)	2.22
5	25(H)	1.86	100(K)	3.55	1258	150(L)	5.34	
6	50(J)	2.10	100	25(H)	1.86	1280	300	3.95
6	75(G)	3.15	125	25	1.49	1500	25(H)	2.10
6	75(G)	3.15	125	25	1.49	1500	25(H)	2.10
7.5	25	1.49	125	25(H)	1.86	1500	50(J)	2.22
7.5	75(G)	3.15	125	25(H)	1.86	1500	50(J)	2.22
7.5	225(P)	6.99	150	50(J)	2.10	1800	50(J)	2.22
8	25	1.49	175	25	1.49	1800	150(L)	5.62
8	25(H)	1.86	175	25(H)	1.86	2000	25(H)	2.10
8	50(J)	2.10	175	500(R)	12.18	2000	60	2.10
10	50	1.86	185	25	1.49	2250	150(L)	5.62
10	25	1.49	200	25	1.49	2500	25	1.66
10	25(H)	1.86	200	25(H)	1.86	2500	50(J)	2.22
10	50	1.86	200	100(K)	3.55	2500	100(K)	3.71
10	150	4.18	200	100	3.25	2500	150(L)	5.62
12	50	1.86	250	25	1.49	2500	500(R)	12.18
12	50	1.86	250	25(H)	1.86	3000	25	1.66
12	500(R)	12.18	300	50(J)	2.10	3000	25	1.66
13	150	4.18	300	50(J)	2.10	3500	25	1.66
13	25	1.49	300	75(G)	3.15	5000	25	1.66
15	25(H)	1.86	300	25	1.49	5000	50(J)	2.22
15	50	1.86	350	50	1.86	5000	50(J)	2.22
15	50(J)	2.10	350	150(L)	5.85	5000	100(K)	4.04
15	75(G)	3.15	350	150(L)	5.85	5000	100(K)	4.04
15	100	3.25	400	25	1.49	7500	100(K)	4.04
15	150(L)	5.05	400	75(G)	3.15	10000	25	1.98
16	50	1.86	500	25	1.49	10000	50(J)	2.50
20	25(H)	1.86	500	25	1.49	10000	50	2.50
20	50(J)	2.10	500	25(H)	1.86	15000	25	1.98
25	25	1.49	500	50	1.86	20000	150(L)	6.95

Notice: Specify type shaft—1/2" screw driver or for knob, or we ship our own choice. Mfg. quantities available at special prices. All initiated types are OHMITE type numbers.

FAIR RADIO SALES • 132 SOUTH MAIN ST. • LIMA, OHIO

A. MOGULL CO.
 17 Warren St., N. Y. 7, N. Y.
 Phone: WORTH 4-0865



COMPASS ELECTRONICS SUPPLY

A Division of Compass Communications Corporation

WE MAINTAIN OUR OWN FULLY EQUIPPED TESTING LABORATORY TO TEST AND GUARANTEE ANYTHING WE SELL

Wholesale, Industrial and Institutional Sales Only

MARINE, GROUND AND AIRBORNE—RADIO, RADAR, AND SONAR—IN STOCK

TEST SETS

- TS-3A/AP
- TS-10A and B
- TS-12/AP
- TS-13/AP
- TS-14
- TS-16/AP
- TS-35A/AP
- TS-36/AP
- TS-61/AP
- TS-62/AP
- TS-74/UPM
- TS-89/AP
- TS-98
- TS-101/AP
- TS-104
- TS-110
- TS-125/AP
- TS-131
- TS-173/UR
- TS-184
- TS-278
- TS-323
- TS-UPM-1
- OAA
- OAP
- OBU
- OAE
- LM
- LU
- IE-19
- I-46
- I-56
- I-208
- I-222
- SCR-211

AND OTHERS

TRANS-MITTERS

- TAJ
- TAQ
- TBL
- TBL
- TBM
- TBN
- TCE
- TCP
- TDE
- TDR
- TDO

AND OTHERS

RECEIVERS

- ARB
- ARC-1
- ARC-3
- ARC-4
- ARC-5
- AR-88
- ART-13
- CR-51
- SLR
- RAK
- RAL
- RAO
- RBB
- RBO
- RBC
- RBL
- RBA
- RBM
- RCH
- BC-224
- BC-312
- BC-314
- BC-344
- BC-348

AND OTHERS

FIELD EQUIPMENT

- SCR-274
- 284
- 380
- 399
- 503
- 536
- 808
- 828
- 851
- BC-151
- 375
- 603
- 604
- 610E
- 683
- 684
- 923
- 924
- 1000
- 1306

MICRO WAVE ACCESSORIES

- Flex. Wave Guide—12" long, UG-51, 52 flanges, new, at..... \$12.50
- Flex. Wave Guide—E-plane 90° gooseneck bend, rect. plain flanges, guide is equiv. to RG-51/U. Airtron #30940, new..... 9.50
- Flex. Twist—E to H, RG-51/U size, UG-51/U & rect. plain flange, Airtron #30810, new, at..... 9.50
- Rigid W. G., Silver pl. brass, RG-51/U with UG-51, 52 flanges, 6' long.... 21.50
- Rigid W. G., RG-51/U, 13" long, 2 UG-51 flanges, new, at..... 10.00
- CG-85/APQ-7, Alum. W. G., RG-51 with two UG-52 flanges, 60° & 22° H plane bends, 22" long, new, at..... 22.50
- Elbows, Sil. pl. brass, RG-51 with UG-51, 52 flanges, mitered 90° H-plane 14.50
- Elbows, Sil. pl. brass, RG-51, two UG-52 flanges, mitered, 90° E-plane. 13.50
- Elbow, RG-51, UG-51, 52 flanges, 90° H-plane and 22° E plane bends. 11.50
- Bi-directional Coupler—UG-51, 52, Type N take offs, Broadband. 27.50
- Rotating Feed Arm Assy's. P/O AN/MPG-1 Sil. pl. brass RG-52, new. write
- Magnets, Alnico V, for 3 & 10 cm Magnetrans various gap widths, 15 lbs. 16.00
- Transformer, Cutput for 725A etc. with fil. wndg. and magnetron well. 21.50
- Utah Pulse xfmr. Philco #352-7190
- Rotating Antenna parts—for AS-18/APS-15, AS-17/APS-3 etc. Drive motors, torque units, wave guide, feed horns, gears etc. write

... and crystal mounts, Klystron mounts, duplexers, I.f. strips, converters and many special bends and devices too numerous to list. Send sketch if possible.

TEST EQUIPMENT

- TS-13/AP-X BAND RADAR TEST SET—Measures power, freq. signal-to-noise ratio. I.F. Bandpass, etc. Input—115/1/60—800. WRITE
- TS-35A/AP-X-BAND—Measures transmitted power & frequency of Radar Transmitters also used for receiver adjustments. NEW WRITE
- TS-100/AP—TEST SCOPE, type A, R, J & X indications, gated & ungated sweep. Int. or Ext. trigger. WRITE
- ECHO BOX, 3 cm, motor driven, new. \$ 97.50
- ECHO BOX, 10 cm, motor driven, new. 97.50
- TS 34, SYNCHROSCOPE, portable. 237.50
- TS 110, S BAND ECHO BOX, hand tuned. 275.00
- Waveguide Termination, TS-332 UG-39 flange. 27.50
- Dummy Load—TS-231/AP, UG-51 flange, Low power. 37.50
- 10cm Lecher Line Wavemeter CG-60ABO. WRITE
- SWR Measuring Eqpt. Model OAK complete with Accessories. WRITE
- TS-131/AP Pick up Assy. WRITE
- TS-184/AP WRITE
- TS-204/AP—SWR Meas. Eqpt. WRITE

TRANSMITTERS

- 125 WATT 300-600 KCS and 3-18.1 MCS; CW and MCW; Master Oscillator
- 400 WATT CW, 50 Watt, Phone; 1.5-4 MCS AC Input, Master Oscillator Mfg. Federal
- 500 and 1000 WATT Low Frequency CW Transmitter 175-600 KCS; AC or DC Input
- 500 and 1000 WATT High Frequency CW Transmitter 2-18.1 MCS; 350 Watts Phone
- 1 KW FM Transmitter; Broadcast, 40-50 MCS AC Input; Mfg.—G. E.
- 2 KW Transmitter; 300-2000 KCS; CW, MCW, Phone 440/3/60 Input; Mfg.—Westinghouse

SPECIAL PURPOSE and TRANSMITTING TUBES

Tube	Selling Price	Tube	Selling Price	Tube	Selling Price	Tube	Selling Price	Tube	Selling Price	Tube	Selling Price	Tube	Selling Price
01A	\$.25	2J32	29.50	4J25	150.00	204-A	60.00	705A	2.75	860	4.25	1635	1.25
OC3	1.00	2J33	32.50	4J26	150.00	211	95	706A-GY	39.50	861	22.50	1642	1.25
OD3	.95	2J34	32.50	4J28	150.00	FG-235A	39.50	707B	14.50	865	1.15	5516	8.50
C1A	5.75	2J36	95.00	4J29	150.00	250TH	21.50	708A	2.75	812A	1.95	5611	99.50
C1B	3.75	2J39	35.00	4J31	150.00	250TL	19.25	714AY	19.50	874	1.00	7193	.50
1W	.35	2J49	65.00	4J33	150.00	FG-271	45.00	715B	9.50	889R	write	8011	.35
VR-92	.45	2J50	70.00	4J34	150.00	FG-274A	75.00	720DY	47.50	891R	write	8012	1.75
1B22	1.75	2J56	132.50	4J42	200.00	285A	7.75	721A	3.25	892	write	8014A	55.00
1B24	12.00	2J61	47.50	4J51	250.00	304TH	8.75	723A/B	18.50	892R	write	8020	2.75
1B35	6.25	2J62	47.50	4J52	245.00	304TL	8.75	725A	19.50	2x2/879	.65	9001	1.10
1N23B	2.75	2K22	35.00	5C29	29.95	307A	2.75	726A	22.50	1616	1.50	9002	.95
2C33	.75	2K25	22.50	5D21	14.50	TR317	5.50	730A	25.00	1619	.50	9006	.35
2C34	.75	2K29	32.50	3I26	125.00	339A	27.50	807	1.35	1624	1.75	1625	.50
2C40	10.50	2K33A	75.00	5C21	29.50	371B	1.25	813	13.25	1626	.35	1629	.45
2C44	.75	2K45	85.00	7BP7	7.75	388A	1.75	829A	10.75				
2D21	1.00	2K55	75.00	7MP7	17.50	415GL	37.50	829B	12.75				
2D29	1.95	3-38A	1.50	12DP7A	45.00	417A	15.00	832A	9.95				
2E22	2.95	3B22	1.75	FG-17	4.25	446A	1.75	832A	45.00				
2E24	3.50	3B24	5.50	FG-57	15.50	446B	3.50	836	3.75				
2J21	13.50	3C31/C1B	3.75	FG-95	22.50	464A	7.50	837	1.45				
2J26	15.00	3E29	14.75	FG-97	39.50	WL531	5.00	843	.35				
2J27	15.00	4C35	15.00	98R	2.75	WL651/656	39.50	849	27.50				
2J31	23.50	4D32	22.50	114B	.35	WL670	9.75	851	45.00				

WHOLESALE, INDUSTRIAL AND INSTITUTIONAL SALES ONLY
OUR EXPORT DEPARTMENT AVAILABLE FOR SPECIAL SERVICE TO OVERSEAS CUSTOMERS

Write for More Details on Any Particular Item in Which You are Interested. These are partial listings only of our stock. Please write for other types.

75 VARICK ST.

All phones: CANAL 6-7455
Cable Address: COMPRADIO, N. Y.

NEW YORK 13, N. Y.

Do you need a dependable source for electronic tubes?

- ALL V. & H. TUBES are new, first quality and unconditionally guaranteed.
- ALL V. & H. TUBES advertised are in stock.
- ALL V. & H. TUBES are standard brands—R.C.A., Sylvania, G.E., Raytheon, Federal, W.E., etc.
- ALL TUBES—NATO, JAN, commercial, transmitting, transmitting and receiving from one source—V. & H. RADIO AND ELECTRONICS!

OA2	1N73	2J55	4J50	6SK7W	252A	574AX	878	5646	5933
OA3	1N76	2J56	4J51	6SL7W	253A	592	879	5647	5948
VR75	1N78	2J61A	4J52	258A	615	595	880	5651	5949
OA4	1N81	2J62A	4J58	65N7W	259A	KUG27	884	5651WA	5963
OA5	1N82	2K25	4PR60A	GT	266B	631-P	885	5654	5965
OB2	1N92	2M25	4X-150A	65117	274B	648-P1	889RA	5657	5977
OB2WA	1N93	2M25	4X-150G	GT	QK284	HK654	891	5659	5987
OB3	1N126	2K26	4X-250B	6X4W	290A	700B	892	5660	5993
VR90	1N127	2K28	4X-300A	7AK7	HF300	703A	893A	5661	5995
OB4	1N128	2K29	F	7BP7, A	300B	704A	898	5663	5998
OC3	1N158	2M30	C5B	7CP1	304B, L	705A	902P1	5667	6002
VR105	1N198	2K33A	5F15B	71P7	706	706	920	5670	6005
OD3	1P23	2K39	5AP1	7VP2	GG305	SERIES	923	5672	6012
VR150	1P24	2K41	5BP1	8D21	CE306	707A, B	929	5677	6021
OD3W	1P30	2K42	5BP4	91P1	307A	708A	930	5678	6022
OZ4	1P31	2K43	5CP2	91P7	310A	710A	931A	5685	6028
REL1	1P32	2K44	5CP3	10E-13	311CT	711A	931A	5686	6045
1A2D	1P36	2K45	5CP2A	10E-22	314A	714A, AY	932	5687	6074
BC1A4B	1P37	2K46	5DP1	10KP7	316A	715A, B, C	955	5687WA	6075
BC1A4C	1P38	2K47	5DP2	10KP17	ML-322	717A	956	5693	6077
"1667"	1P40	2K48	A-11	A-11	327A	719A	957	5694	6078
1A4	1P42	2K50	5FP14A	12A7	C-335	720	958A	5695	6080
BS-1	1P43	2K51	5GP1	WA	337A	SERIES	959	5696	6080WA
C1B, B	1P45	2K54	5HP4	342A	1217	701	959	5697	6082
2AS-15	2A5-15	2K56	5J23	WA	348A	CE-722A	1003	5702WA	6082
1C22	2A21	2X2A	5J26	5J26	15E	CK-722	C11005	5703	6088
1B23	2P1	5J29	5J29	F617	314A, F	722A/B	C11009	5703WA	6096
1B24	2BP11	3B	5J30	RX21	359A	724B	TR 1032K	5718	6100
1B24A	2B22	3B4	5J32	HK24	359A	724B, B, C	VC-1258	5718	6100
1B27	3B22	3B4	5J32	WA	388A	726A, B, C	DC-1285	5719	6101
1B35	2C4	3B24W.	5LP1	RK20A	388A	726	C14-1301	5724	6110
1B35A	2C22	3B4	5LP7	RK25	393A	SERIES	1603	5722	6111
1B35B	3B5A	3B25	5P15CY	5P15CY	393A	750TL	1611	5725	6112
1B37A	2C35	3B26	5R4WGY	25Z6W	397A	800	1613	5727	6116
1B38	3B38	3B28	5RP11A	GT	401A	801A	1614	5727	6140
1B40	2C37	3B29	5V3W	26Z5W	403A	802	1616	5732	6141
1B42	2C39, A	3C22	5V3W	28D7W	404A	803	1619	5734	6147
1B44	2C40	3C23	5ZP16	31Z	407A	804	162	5744	6143
1B46	2C42	3C33	6AF7W	RK-34	408A	805	1622	5749	6149
1B47	2C43	3C45	6AF4A	35T, TG	409A	806	1624	5750	6186
1B50	2C44	3D6	6AG7Y	RK-39	412A	807, W	1625	5751	6188
1B51	2C46	3D1A	6AH1A	TL-40	418A	809	1626	5763	6189
1B52	2C50	3D22	6AH6	TZ-40	416A, B	809	1629	5764	6199
1B53	2C51	3D24	6AJ6	RK-47	417A/5842	810	1630	5765	6201
1B54	2C52	3D1, 52	6AJ6	RK-49	418A	811, A	1631	5783	6205
1B57	2C53	3E29	6AK5W	V-50	419A	812, A	1632	5783WA	6216
1B58	2D21	3EP1	6ALS5W	52HAP7	420A	813	1633	5784	6246
1B59	2D12, W	3EP7A	6AN5, WA	RK-65	421A	814	1635	5787	6247
1B60	2E22	3GP1A	6AN6	HY-65	422A	815	1641	5792	6249
1B63A	2E24	3J31	6AQ5W	HY-69	423A	816	1642	5793	6280
1B98	2E25A	3K21	6AR5	4K-77	424A	817	1643	5794	6293
1B100	2E26	3K23	6AS5W	RK-75	428A	825	1644	5794	6293
1C	2E30	3L4	6AS7C	RK-75	429A	828	1644	5798	6293
1C1	2E31	CA-4	6BA6W	75T, TL	431A	829B	1645	5798	6293
1C10	2E32	5N-4	6B7	BR-90	438A	830B	1850A	5800	6008
1C11	2E35	4-65A	6BE6W	CV-52	446A, B	832A	1907	5803	6008
1C12	2E36	4-125A	6B7	C-100A	438A	833A	1961	5817	6011
1C13	2E37	4-250A	6B7F, W	HF100	450TH, TL	834	2050	5818	6012, A
ABC	2E38	4-1,000A	6B8E	100TH, TL	450TH, TL	836	2050	5819	6012, A
1N21	2E39	4-250A	6B8E	100TH, TL	450TH, TL	836	2050	5819	6012, A
1N22	2E41	4-1,000A	6B8E	100TH, TL	450TH, TL	836	2050	5819	6012, A
1N23, A	2E42	4-250A	6B8E	100TH, TL	450TH, TL	836	2050	5819	6012, A
G, C, CR	2E43	4-250A	6B8E	100TH, TL	450TH, TL	836	2050	5819	6012, A
1N25	2E44	4-250A	6B8E	100TH, TL	450TH, TL	836	2050	5819	6012, A
1N26	2E45	4-250A	6B8E	100TH, TL	450TH, TL	836	2050	5819	6012, A
1N28	2E46	4-250A	6B8E	100TH, TL	450TH, TL	836	2050	5819	6012, A
1N31	2E47	4-250A	6B8E	100TH, TL	450TH, TL	836	2050	5819	6012, A
1N32	2E48	4-250A	6B8E	100TH, TL	450TH, TL	836	2050	5819	6012, A
1N34, A	2E49	4-250A	6B8E	100TH, TL	450TH, TL	836	2050	5819	6012, A
1N35	2E50	4-250A	6B8E	100TH, TL	450TH, TL	836	2050	5819	6012, A
1N36	2E51	4-250A	6B8E	100TH, TL	450TH, TL	836	2050	5819	6012, A
1N37	2E52	4-250A	6B8E	100TH, TL	450TH, TL	836	2050	5819	6012, A
1N38	2E53	4-250A	6B8E	100TH, TL	450TH, TL	836	2050	5819	6012, A
1N39	2E54	4-250A	6B8E	100TH, TL	450TH, TL	836	2050	5819	6012, A
1N41	2E55	4-250A	6B8E	100TH, TL	450TH, TL	836	2050	5819	6012, A
1N42	2E56	4-250A	6B8E	100TH, TL	450TH, TL	836	2050	5819	6012, A
1N43	2E57	4-250A	6B8E	100TH, TL	450TH, TL	836	2050	5819	6012, A
1N44	2E58	4-250A	6B8E	100TH, TL	450TH, TL	836	2050	5819	6012, A
1N47	2E59	4-250A	6B8E	100TH, TL	450TH, TL	836	2050	5819	6012, A
1N53	2E60	4-250A	6B8E	100TH, TL	450TH, TL	836	2050	5819	6012, A
1N55	2E61	4-250A	6B8E	100TH, TL	450TH, TL	836	2050	5819	6012, A
1W56A	2E62	4-250A	6B8E	100TH, TL	450TH, TL	836	2050	5819	6012, A
1N58	2E63	4-250A	6B8E	100TH, TL	450TH, TL	836	2050	5819	6012, A
1N60	2E64	4-250A	6B8E	100TH, TL	450TH, TL	836	2050	5819	6012, A
1N69	2E65	4-250A	6B8E	100TH, TL	450TH, TL	836	2050	5819	6012, A
1N70	2E66	4-250A	6B8E	100TH, TL	450TH, TL	836	2050	5819	6012, A

Prices and catalogues on request.

SEND US YOUR INQUIRIES TODAY

V & H RADIO AND ELECTRONICS SUPPLY
2029-2047 W. VENICE BLVD. · LOS ANGELES 6, CALIF. · Republic 0215

PHOTOCON SALES

417 N. Foothill Blvd. SY camore 2-4131
Pasadena 8, Calif. RY an 1-6751
CABLE: Photocon, Pasadena

LORAN EQUIPMENT

AN/APN4B Loran with ID6B Indicator, R9B Receiver, Crystal, Mounts, Plugs, and Manual	New	\$129.95
PE-206 Inverter	New	14.95

TS-120/Up Test Set	Excellent	Pur*
Hewlett Packard Wide Band Amplifiers Model 460A	Excellent	Pur*
Model 460B	Excellent	Pur*
Browning Model P4-E Cathode Ray Synchroscope, 5" C.R.T.		99.50
Hewlett Packard Square Wave Generator Model 210A		Pur*
Allen B. Dumont Cathode-Ray Indicator Type 281A, 115/220V AC. 60 Cycle		Pur*
Allen B. Dumont High Voltage Power Supply Type 286-A	Excellent	Pur*
BC-223AX Transmitter with Tubes, TU17, TU18, TUQ5, 2000-5250 Kc. Oscillator		32.50
BC-221, Freq. Meter 125Kc.-20Mc. with Calibration Book and Xtal Excellent		99.50
Esterline-Angus Model AW Recording Voltmeter 0.10V. AC. 400 Ohms		150.00
Weston Model 686 True Mutual Conductance Vacuum Tube Analyzer	New	450.00
MG-149F Inverter	Excellent	49.50
FT-524 General Electric 3200 Wattsecond Photoflash Tube	New	20.00
80 Mfd. 4000 V. 640 Wattsecond Photoflash Capacitor	New	50.00
APNI Altimeter Indicator	New	2.95
CD-307A Extension Cords	New	1.00
Radio Surplus Conversion Manual Vol. 1	New	2.50
Vol. 11	New	2.50
Handbook of Operating Instructions for Radio Set AN/CRT3	New	1.50

We have one of the largest and most complete electronic stocks in the country... Thousands of tubes, capacitors, plugs, accessories, transmitters, receivers, test equipment, etc.

WRITE FOR OUR 1955 CATALOG!

TEST EQUIPMENT

HEWLETT PACKARD 200B Audio Oscillator (Rack Mounting type) 20 to 20,000 cycles. Like new...	\$75.00
HEWLETT PACKARD 400-A Vacuum Tube Voltmeter—Like new...	\$95.00
HEWLETT PACKARD 325 Distortion Analyzer—30 to 15,000 cycles. Excellent	\$220.00
GENERAL RADIO 713-B Beat Frequency Oscillator—0-40 KC. Excellent	\$225.00
GENERAL RADIO 731-B Modulation Monitor—0.5 to 8 MC or 3 to 60 MC carrier. Like new	\$110.00
GENERAL RADIO 723-C Vacuum Tube Fork—New	\$89.50
DUMONT 208 Cathode Ray Oscilloscope—Excellent	\$95.00
NAVY LAE-1 Signal Generator—\$10 to 1300 MC, CW or internal pulse modulation. New	\$225.00
MEASUREMENTS CORP. 79-B Pulse Generator—New	\$165.00

All prices net FOB Phila., Pa.
SEND FOR LATEST CATALOG

ELECTRONIC RESEARCH LABS.

715-19 ARCH STREET
Phila. 6, Pa. Phone MA 7-6771

FOR SALE

UNUSED SURPLUS COMPONENTS

Power Rheostats — Power Resistors — "J" — "JJ" Pots — Wire Wound Pots — Glass Ferrule Resistors — Precision Resistors

Surplus Bought—Send Your List

J. C. DIXON: Troy, Ind.

TELEPHONE RELAYS

See Our May Ad for a more complete listing



PARTIAL LISTING OF OUR CLARE TYPE C STANDARD SIZE D.C. TELEPHONE RELAYS

Coil	Contacts	Operates at	Price
1) 1200 ohm 1C	1C	24 to 85V.	\$2.50 ea.
2) 1300 ohm 1B	1B	24 to 85V.	2.25 ea.
3) 1300 ohm 2A-1B	2A-1B	24 to 85V.	2.75 ea.
4) 1300 ohm 2C-1A	2C-1A	24 to 85V.	3.00 ea.
5) 1300 ohm 4C-2A	4C-2A	30 to 110V.	4.00 ea.
6) 1300 ohm 2A-1B-1C-1D	2A-1B-1C-1D	30 to 85V.	3.00 ea.
7) 1300 ohm 6C	6C	30 to 85V.	4.50 ea.
8) 1300 ohm 4C-3A-1B	4C-3A-1B	36 to 110V.	4.00 ea.
9) 2500 ohm 1A	1A	24 to 110V.	2.25 ea.
10) 2000 ohm 2C-1A	2C-1A	24 to 110V.	3.00 ea.
11) 2000 ohm 4C-2A	4C-2A	30 to 110V.	3.25 ea.
12) 2000 ohm 4C-2A	4C-2A	30 to 110V.	4.00 ea.
13) 2000 ohm 6C	6C	30 to 110V.	4.50 ea.
14) 2000 ohm 8A	8A	36 to 110V.	3.50 ea.
15) 2000 ohm 2D	2D	24 to 110V.	2.50 ea.
16) 3000 ohm 3A	3		

ELECTRONIC

WAR TERMINATION INVENTORIES

WRITE OR WIRE FOR INFORMATION ON OUR COMPLETE LINE OF SURPLUS ELECTRONIC COMPONENTS. ALL PRICES NET F.O.B. PASADENA, CALIFORNIA

C&H SALES CO.

2176-E East Colorado St.
Pasadena 8, California
RYan 1-7393

INVERTERS

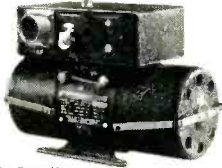

- 10042-1-A Bendix
DC Input 14 volts; output: 115 volts; 100 cycles. 1-phase; 50 watt **\$35.00**
- 12116-2-A Bendix
Output: 115 VAC; 400 cyc; single phase; 45 amp. Input: 24 VDC, 5 amps. **\$35.00**
- 12117 Bendix
Output: 26 volts; 400 cycles, 6 volt amperes. 1 phase. Input: 24 VDC; 1 amp. **\$15.00**
- 12121 Bendix
Input: 24 volt D.C. 18 amp. 12000 r.p.m. Output: 115 volts, 400 cycle, 3-phase, 250 volt amp, 7 pf. **\$49.50**
- 12123 Bendix
Output: 115 V; 3-phase; 400 cycle; amps .5 Input: 24 VDC; 12 amp. **\$49.50**
- 12126-2-A Bendix
Output: 26 volts; 3 phase; 400 cycle; 10 VA; .6 PF. Input: 27.5 volts DC: 1.25 amps. **\$24.50**
- 12130-3-B Bendix
Output: 125.5 VAC; 1.5 amps. 400 cycles single phase, 141 VA. Input: 20-30 VDC. 18-12 amps. Voltage and frequency regulated. **\$49.50**
- 12133 Bendix
Input: 26/29 volt D.C., 28 amps Output: 115 volt, 3 phase, 400 cycle, 250 volt amp., .8 pf. **\$59.00**
- 12143-2-A Bendix
Output: 115 volts: 400 cycles; 250 VA; single phase pf. 9-1. DC Input: 26-29 VDC; 25-22 amp; voltage & frequency regulated **\$49.50**
- 778 Bendix
Output: 115 volt, 400 cycle; 190 VA; single phase and 26 volt, 400 cycle, 60 VA, single phase. Input: 24 VDC. **\$37.50**
- 10285 Leland
Output: 115 volts AC; 750 VA, 3 phase, 400 cycle, .90 pf and 26 volts. 50 VA, single phase, 400 cycle, .40 pf. Input: 27.5 VDC, 60 amps. cont. duty, 6000 rpm. Voltage and frequency regulated. **\$59.50**
- 10339 Leland
Output: 115 volts; 190 VA; single phase; 400 cycle; .90 pf. and 26 volts. 50 VA; 400 cycle, .40 pf. Input: 27.5 volts DC, 18 amps cont. duty, voltage and freq. regulated. **\$49.50**
- 10486 Leland
Output: 115 VAC; 400 cycles; 3-phase; 175 VA; .80 pf. Input: 27.5 DC; 12.5 amps; cont. duty. **\$70.00**
- 10563 Leland
Output: 115 VAC; 400 cycle; 3-phase; 115 VA; 75 pf. Input: 28.5 VDC; 12 amps. **\$35.00**
- PE109 Leland
Output: 115 VAC, 400 cyc; single phase; 1.53 amp; 8000 rpm. Input: 13.5 VDC; 29 amp. **\$50.00**
- PE218 Leland
Output: 115 VAC; single phase pf 90; 380/500 cycle; 1500 VA. Input: 25-28 VDC; 92 amps; 8000 rpm; Exc. Volts 27.5 BRAND NEW. **\$30.00**
- MG149F Holtzer-Cabot
Output: 26 VAC @ 250 VA; 115 V. @ 500 VA; single phase; 400 cycle; Input: 24 VDC @ 36 amps. **\$40.00**
- MG153 Holtzer-Cabot
Input: 24 VDC; 52 amps. Output: 115 volts — 400 cycles, 3-phase, 750 VA. Voltage and frequency regulated. **\$95.00**
- DMF2506M Continental Electric
24-30 volts input; 5.5-45 amps; cont. duty. Output: 115 volts; .44 amps; 400 cyc; 1 phase; pf 1.0; 50 watts. **\$39.50**

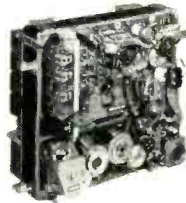

PARALLAX COMPUTER used with B29 sighting station; approximate dimensions 18" x 19" x 10"; approximate weight 100 lbs. Contains:
Servo amplifier
7-24VDC Gearhead Motors
6-4C0 cy. Selsyns
Position Analyzer
Many mechanical differentials
Hundreds of precision gears
Relays
Government cost approximately **\$8000.00**
Our price **\$ 100.00**

SELSYNS-SYNCHROS



- | | |
|--------------------------------------|----------------|
| 1S F Syn. Mtr. 115/90V 400cy. | \$12.50 |
| 2J1F Gen. 115/57.5V 400 cy. | 7.50 |
| 2J1FJ Gen. 115/57.5V 400 cy. | 10.00 |
| 2J1FA1 Gen. 115/57.5V 400 cy. | 7.50 |
| 2J1G Cont. Trans. | |
| 57.5/57.5V 400 cy. | 5.00 |
| 2J1H Diff. Gen. 57.5V 400 cy. | 7.50 |
| 2J5D Cont. Trans. 105/55V 60 cy. | 17.50 |
| 2J5F1 Cont. Trans. 105/55V 60 cy. | 17.50 |
| 2J5H Gen. 115/105V 60 cy. | 17.50 |
| 2J15M1 Gen. 115/57.5V 400 cy. | 17.50 |
| 5CT Cont. Trans. 90/55V 60 cy. | 34.50 |
| 5D Diff. Mtr. 90/90V 60 cy. | 34.50 |
| 5DG Diff. Gen. 90/90V 60 cy. | 34.50 |
| 5F Syn. Mtr. 115/90VAC 60 cy. | 34.50 |
| 5G Syn. Gen. 115/90VAC 60 cy. | 34.50 |
| 5HC Cont. Trans. 90/55V 60 cy. | 42.50 |
| 5SDG Diff. Gen. 90/90V 400 cy. | 12.50 |
| 6DG Diff. Gen. 90/90V 60 cy. | 25.00 |
| 6G Syn. Gen. 115/90VAC 60 cy. | 34.50 |
| 7G Syn. Gen. 115/90VAC 60 cy. | 42.50 |
| R110-2A Kearfott Cont. Mtr. | |
| 115V 400 cy. | 17.50 |
| R200-1A Kearfott Cont. Trans. | |
| 26, 11.8V 400 cy. | 15.00 |
| R210-1A Kearfott Trans. | |
| 26, 11.8V 400 cy. | 15.00 |
| R235-1A Kearfott Resolver | |
| 26, 11.8V 400 cy. | 22.50 |
| C56701 Type 11-4 Rep. 115V 60 cy. | 20.00 |
| C69405-2 Type I-1 Transm. | |
| 115V 60 cy. | 20.00 |
| C69406 Syn. Transm. 115V 60 cy. | 20.00 |
| C69406-1 Type II-2 Rep. 115V 60 cy. | 20.00 |
| C78166 Volt. Rec. 115V 60 cy. | 10.00 |
| C78248 Syn. Transm. 115V 60 cy. | 12.50 |
| C78249 Syn. Diff. 115V 60 cy. | 5.00 |
| C78863 Repeater 115V 60 cy. | 7.50 |
| C79331 Transm. Type 1-4 115V 60 cy. | 20.00 |
| 851 Bendix Autosyn Mtr. 32V 60 cy. | 7.50 |
| 403 Kollsman Autosyn Mtr. 32V 60 cy. | 7.50 |
| CK5 Bendix Mtr. 2 phase 26V 400 cy. | 17.50 |
| FPE-4-1 Resolver 400 cy. | 25.00 |
| FJE-43-9 Resolver 115V 400 cy. | 25.00 |
| 999-0411 Kollsman 26V 400 cy. | 15.00 |
| 1377-C410 Kollsman 26V 400 cy. | 10.00 |
| 1515B-0410 Kollsman 26V 400 cy. | 20.00 |
| 10047-2-A Bendix 26V 400 cy. | 12.50 |
| 2900 Transicoil 115V 400 cy. | 15.00 |

PIONEER TORQUE UNITS



Type 12602-1-A. Includes CK 5 Servo motor coupled to output shaft thru 125:1 gear reduction train. Output shaft coupled to autosyn follow-up (AY-43). Ratio of output shaft to follow-up autosyn is 30:1 Includes base mounting type cover for motor and gear train. **\$34.95**

TELECON OSCILLATOR



Input: 115 volts, 60 cycle; Output: 26.5 volts, 400 cycle 3-watts @ 250 ohm load. Ideal for laboratory use . . . approx. 10" x 7" x 8", wt. 16 lbs. **\$29.95**

SENSITIVE INTEGRATING GYROS



Minneapolis-Honeywell part no. GG1A-2 series 1—Brand New
This is the famous HIG gyro which is being used in missile guidance systems, radar stabilization and fine control systems. Limited quantity available. Original cost approximately **\$1500.00**
Our price **\$ 100.00**

SMALL DC MOTORS



- (approx. size overall 3/4" x 1 1/4" dia. :)
- | | |
|--|----------------|
| 506900 Delco PM 27.5 VDC 250 rpm | \$12.50 |
| 5069230 Delco PM 27.5 VDC 145 rpm | 15.00 |
| 5068750 Delco 27.5 VDC 160 rpm w/brake | 6.50 |
| 5068571 Delco PM 27.5 VDC 10,000 rpm (1x1x2") | 5.00 |
| 5069625 Delco 27.5 VDC 120 rpm w/governor | 15.00 |
| MM A-11 Globe PM 24 VDC | 7.50 |
| 5BA10AJ18 GE 24 VDC 110 rpm | 10.00 |
| 5BA10AJ37 GE 27 VDC 250 rpm reversible | 10.00 |
| 5BA10AJ52 27 VDC 145 rpm reversible | 12.50 |
| 806069 Oster series reversible 1/50 h.p. 10,000 rpm 27.5 VDC 1 1/2" x 3 1/2" | 5.00 |
| C-28P-1A 27 VDC 1/100 h.p. 7,000 rpm | 3.00 |
| 7100-B PM Hansen 24 VDC 160 rpm | 7.50 |
| SSFD-6-1 Diehl PM 27.5 VDC 10,000 rpm | 4.00 |
| 6-volt PM Mtr. mfgd. by Hansen 5,000 rpm 1 1/4" in dia. 2" long overall | 4.00 |

TELEMARINE

PARTIAL LISTING OF OUTSTANDING SURPLUS COMMUNICATIONS EQPT.

WE 248-A RADIOTELEPHONE EQPT. 250/350 Watts, 2-20 MC., 50 Channels Transmit and Receive all crystal-controlled, monitors 3 separate channels simultaneously, uses standard modern type tubes. COMPLETE, NEW (Not Gov't. Surplus). Operates from 110 Volts, 50/60 Cycles AC. IDEAL FOR SHIP RADIO-TELEPHONE, OR FIXED-RADIO INSTALLATION. WRITE FOR DESCRIPTIVE LITERATURE AND PRICE.

GE 10 KW RF POWER AMPLIFIERS. 89-108 MC. Class "C", with separate Rectifier Power Supply. Operation from 220 V., 3-phase, 50/60 Cycles AC. Easily modified for other frequencies. NEW, Not Gov't. Surplus. WRITE FOR DESCRIPTIVE LITERATURE AND PRICE.

MODEL LSR-420F. RADIO BEACON OR SHIP RADIO TRANSMITTER. Freq. Range 275-510 KC. Power Output 100 Watts CW, 150 Watts MCW. Operates from 115 V. AC, 60 C. New Exprt.

LSR-520-C RADIO BEACON POWER AMPLIFIER. Class B Linear Amplifier used with above LSR-420 to increase power output to 600 Watts CW or 800 Watts MCW. Operates from 115 Volts 60 C. AC.

BC-797 VHF 110-126 MC. 50W. AM Output for 110 V. 50/60 C. AC.

BC-160 Collins Autocount Transmitter, 250 W. A1, 200 W. A3 or A2, 10 Channels 2-16 mc.

BC-447, 300 W. A1, 4-13.4 mc, 2-channels.

SCR-510/610. FM Trans-Receiver, 20 to 28 and 28 to 37 mc respectively. With 1F-117 or 120 Vibrator Power Supply and other accessories.

SCR-619. FM Trans-Receiver 27 to 38.9 mc. complete with all accessories. NEW units.

SCR-522. VHF, 3 Channel, 100-150 MC Trans-Recv. Eqr. for Plane or Ground Communications.

SCR-511. Walky-Talky, 3-6 MC. Crystal Controlled Trans-Recv. with Plug-In Units for Freq. Changing.

BC-611 and MAB HANDY and WALKIE-TALKIES.

SCR-300 (BC-1000) WALKIE-TALKIES, 40-48 MC 2 channel FM Trans-Receivers.

TCS X-mtr-Receiver for Ship or Shore.

TCS Accessories available: Remote Controls, Antenna, Loading Coils, Etc.

TBK HP 500W 2-20 Mc Transmitter with MG, Starter and Spares.

TAJ 500 W. Output, 175-550 Kc. with M.G. for AC or DC operation.

TAQ. Same as TAJ above but 1,000/1,500 W. output with MG.

TBL 350 W. Output, A1, A3, IF, & H.F. for AC or DC operation.

PE-75U Gas Engine Generators. NEW. w/Spares.

21/GR-3-C Sound Ranging Microphones for locating Artillery Fire.

NAA Underwater Beacon Equipment.

BD-57-B Switchboards, telephone.

LINK-1498. VHF Trans-Rcvg Eqpt, 70-100 MC, 50 Watts output FM. Available in 14 VDC & 110 V AC operation.

GO-G 100/125 W. IF/HP Ship or Aircraft Transmitter, A1 or A2 Emission. All New with Spares.

150-AV Mackay IR Ship X-mtrs.

8707 RMCA Ship Radio Compass.

LRN-1A Loran Equipment.

TE-54 & 55 Cable Vulcanizing Equipment.

SB-14GV Console Switchboard.

SB-23/GTA Power Supply for above.

BC-224 Receivers.

HEADQUARTERS FOR TCS EQUIPMENT AND SPARE PARTS: WALKIE TALKIES (SCR-300 OR BC-1000) AND SPARE PARTS: HANDY TALKIES (SCR-536 OR BC-611) AND SPARE PARTS, SCR-543 (BC-669 AND ACCESSORIES) IN NEW OR LIKE NEW CONDITION. WE HAVE LARGE QUANTITIES OF THESE EQUIPMENTS. ALSO DM-35 DYNAMOTORS AND PE-104 (FOR SCR-284) GENERATOR POWER SUPPLIES, GN-50 HAND GENERATORS, AND PE-237 POWER SUPPLIES FOR SCR-694 AND GRC-9 EQUIPMENTS.

SELECTIVE RINGER for MOBILE or SHIP-TO-SHORE RADIOTELEPHONES. Permits Phone Operator to call your Radiotelephone exclusively when operator has a call for you, by ringing a bell or lighting a light. Designed & Mfd. by Western Electric, MODEL 107A, modern, compact and efficient. Can be attached to any receiver, complete Instruction Book supplied. Dim.: 15 1/2" long, 3 1/2" high, 5 1/2" wide. Sng. Wt. 25 lbs. NEW UNITS. Reg. value \$245.00 each. OUR LOW PRICE—EACH \$85.00.

EXPORTERS, GOVERNMENT AGENCIES, INDUSTRIALS!

We have a large stock of Transmitters, Receivers, Walkie-Talkies, VHF Equipment, Ship & Shore Communications, FM Broadcast Stations, Radar, Accessories, etc. Write and tell us of your requirements. Descriptive literature and prices available upon request.

TELEMARINE

COMMUNICATIONS CO.

3040 W. 21st Street, Brooklyn 24, N. Y.

Phones: ES 2-4300

CABLE ADDRESS: TELEMARINE, N. Y.



3 Cond. KOILED KORDS
22 inches long stretches to 9 feet
List price \$3.00 Net \$1.26

REVERSIBLE GEARED-MOTOR

Delco-PM-Permanent Magnet Alnico Field Motor

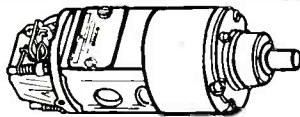

#5071895 1/4 SHAFT or 11/16 GEAR... \$17.50
#5069600 \$18.50

Clamps to hold motor: \$1.50 ea.

GRAIN OF CORN LAMPS

10 for \$3.00—100 for \$25.00



#328, 6 Volts #326, 2 1/2 Volts #321, 28 Volts

TELECHRON Motors

4 RPM on 50 cy	3.6 RPM. 3.15
or 4 1/4 RPM	1 RPM... 3.95
on 60 cy. \$2.85	3 R.P. Hr 2.85
2 RPM... \$2.90	1 R.P. 12 Hr 2.80
3 RPM... 3.90	1 R.P. 12 Hr 2.25
4 RPM... 2.90	60 RPM... 4.85

Laboratory Special 1 of Each Motor \$25.

please include postage

BLAN

BLOWERS 115 Volts A. C. 60 cy.



REDMOND 5" 18 watts... \$8.95
DELCO 60 cfm, 40 watts... \$14.50
#5062369 used in 584 RADAR

HAND WOUND 10 Sec. to 24 Min. TIMER SWITCH... \$1.25



6 Watt Most POWERFUL TELECHRON 1 RPM
110 v. 60 cy... \$6.50
10 for... \$50.00

3" Round Elapsed Time Meter \$13.75

Square Case \$14.50

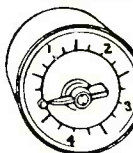

MARKTIME 5 HOUR SWITCH

A 10 amp. timing device. Pointer moves back to zero after time elapses. Ideal for shutting off radios and TV sets when you go to bed. Limited supply at this special PRICE... \$4.90
Also available in 15 min., or 30 min. or 1 hr. at... \$6.50

HAYDON TIMING MOTORS
110v 60 cycle 30 RPM... \$2.60
110v 60 cycle 1 RPM... 2.60
230V 51 RPM... 1.00
60CY 12 RPM... 1.00



EST. 1923 64P Dey Street New York 7, N. Y.

S BAND

GUIDED MISSILE BEACON

FILTER CAVITY F-28/APN-19

2700-2900mc. Max. 1.5-db loss at ctr. freq. over band, 3db at 15 mc band ends. JAN spec. Ideal as standard reference cavity. Brand new. Guaranteed, \$37.50
AN/APN-19 Crystal Mounting, \$19.50
COAXIAL CRYSTAL MOUNT. Type N fittings, tuneable silver plated. Holds any IN21 type Xtal. \$9.50.
LIGHTHOUSE CAVITY. For 2C40 tube. Tuneable 2700-2900mc w/suitable grid cycles. Can be freq. modulated, \$22.50.
FEEDBACK DIPOLE 1/2" coax. 1 1/4" o.a. \$14.50.

60MC. IF STRIP

Uses (6) 6AK5 Mfg. Western Electric. Price, \$9.50.

E PLANE BENDS UG39/40 std Radius, \$14.50.

MITRED BEND. Vy Short Radius, E plane, \$10.00.

TRANSISTOR, 1"x1/2" to 1 1/4"x3/4" Lgh 3 1/2", \$6.50.

TWIST 90 DEGREE, UG39 to UG40. Silver plated, \$6.50.

CRYSTAL MOUNT. Hold any IN23 type xtal, 1" x " guide std coax output.

UG40 fig. input, \$15.00.

DIRECTIONAL COUPLER. Uni. or Bi directional types 20db coax "N" output.

UG39 fig. to UG40 chk., \$24.50.

DUPLEXER. latest type incl. ATR switch tube mount, directional coupler, etc. 1"x3/4" guide, \$27.50.

FLEX. SECT. UG39 fig. \$10.00, \$12" at \$17.50.

LINE STRETCHER. VSVR matching device for XMSN Lines, \$34.50.

DIRECTIONAL COUPLER bi-dir. UG-115/U Hanges, \$29.50.

KLYSTRON OUTPUT COUPLING for 2K50 RG 66/U guide, \$6.50.

H BEND 90 deg. CG346/U.

E BEND 90 deg. CG345/U. Cplg. UG-117 to UG-116. RG66 guide, \$12.50.

ADAPTERS 1 1/2" lg UG116 to UG116, UG117 to UG117 ea. \$5.00

TEST EQUIPMENT

MIT type TS155 Signal Generator, 2C40 precision lighthouse cavity 2700-2900mc, wg below cutoff varia. attenuator, power meas. thermistor bridge, 115vac regulated pwr. supply. OAP Waremeter-Freq. Meter 100-200mc Band, \$125.

10cm Thermistor Bridge—Power Meters, Western Electric, \$65.

ECHO BOX. TS-207/UP 2700-2900mc. \$64.50.

ECHO BOX. OBU-3, Precision w/detector and meter, \$325.00.

CG-97/AP DUMMY LOAD, 3/4 coax. 250kw peak, 100watts nominal average pwr. handling. New, \$27.50.

RADIO-RESEARCH INSTRUMENT CO.

550 - 5 Ave., N. Y. 19, N. Y. Tel: JU 6-4691
PAUL J. PLISHNER

CAPACITORS

gov't termination purchase

Oil filled-impreg., micas.

Write for current listings

RESISTORS

insl. quality 1/2-1 & 2 watts

Wirewound—3-5-10-20-50 watts

GOULD GREEN, 252 Greenwich St., NYC 7

FOR SALE

Wholesale to Institutions
Industrials & Dealers Only

- RELAYS ● METERS
- MOTORS ● BLOWERS
- SWITCHES ● MAGNETS
- SYNCHROS ● RECEIVERS
- I.F. STRIPS ● NETWORKS
- ANTENNAS ● RESISTORS
- DUPLEXERS ● CAPACITORS
- CONNECTORS ● CONTACTORS
- INSTRUMENTS ● WAVE GUIDES
- MODULATORS ● DYNAMOTORS
- TRANSMITTERS ● TRANSFORMERS
- TORQUE UNITS ● SYNCHRONIZERS
- TEST EQUIPMENT ● CONTROL BOXES
- POTENTIOMETERS ● KLYSTRON MOUNTS
- JUNCTION BOXES ● MICROWAVE PARTS

ALL TYPES OF TUBES

WRITE TO

AMBER INDUSTRIAL CORP.

METALS AND SALVAGE DIVISION

732 E. Monument Ave. Dayton, Ohio

RCA TV CAMERA

NEW Surplus

for Labs! Export!

Industrials!

Medicine!

Closed Circuit

TV!

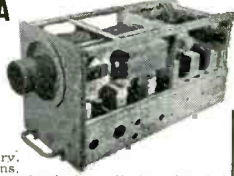

Ideal for labs, industry, prisons, TV technicians, swim pools, medical—"mechanical eye" for closed circuit TV, 1846 Ictoscope, 8-stroke video amplifier and clipper. THE REAL THING! Send for new, free, complete technical data. SOLD AT FRACTION OF REAL VALUE!

Write today! Note our new address!

Harjo Sales Co.

Mailing Address: Box 1187-E10, MAGNOLIA PARK STATION, BURBANK, CALIF.
Office-Warehouse: Dept. E-9, 503 N. Victory Blvd., BURBANK, CALIFORNIA

RELAYS



ALLIED • LEACH • TELEPHONE TYPE •
MINIATURE AIRCRAFT • GUARDIAN
• SIGMA • HERMETICALLY SEALED •
SENSITROLS • STEPPING SWITCHES •
and many others

Largest Stock in the World
Production Quantities

WESTERN ELECTRIC MERCURY CONTACT



D171584; (Equivalent to 275B); SPDT; 1 coil of 4500 ohms plus 24V Heater; High pressure sealed; Octal plug base. Operating current: 6.6 ma, release current: 5.2 ma. Overall length: 3 1/4", overall diameter: 1 3/16"; #R1021 \$6.95 ea.
10 for 65.00 100 for 625.00
D168479; (Equivalent to 275C); SPDT; 2 coils: 3300 and 700 ohms; High pressure sealed; Octal plug base. Operating current: Windings in series 6.6 ma, release: 5.2; #1022 8.95 ea.
10 for 82.50 100 for 750.00

SIGMA SENSITIVE



SIGMA 4F8000S; 1 ma; SPDT(IC); 8000 ohm; #R425 3.95 ea.
3 for 10.00 10 for 30.00
SIGMA 5F16000S; 0.5 ma; SPDT (IC); 16000 ohm; #R627 5.95 ea.
10 for 50.00 100 for 450.00
SIGMA 5J016000LG; 1 ma; IC, 1A; Octal plug base; Hermetically sealed; #R1118 3.95 ea.

HERMETICALLY SEALED



ALLIED SMHX-1; 24VDC; 6PDT(6C); 10 Amp contacts; 230 ohm; Solder lug header; #R271 6.50 ea.
ALLIED SKHXCC; 24VDC; DPDT(2C); 425 ohm; Solder lug header; #R85 4.95 ea.
ALLIED SKHXCCCC; 24VDC; 4PDT(4C); 425 ohm; Solder lug header; #R86 5.50 ea.
POTTER BRUMFIELD MH-17AM; 115V; 50-60 cyc; 4PDT; Solder lug header; #R87 5.95 ea.

A-C RELAYS

GUARDIAN SNAP-ACTION; SPST; 30 Amp contacts; 115V, 50-60 cyc; #R1023 1.95 ea.
10 for 18.00
220V, 50-60 cyc; #R1024 2.50 ea.
0 for 22.50



ALLIED P012A115; 115V, 50-60 cyc; 4PDT; 10 Amp contacts; #R1025 4.50 ea.
10 for 40.00 100 for 350.00

24 VOLT TRANSFORMER; 1.5 Amp; Pri; 115V; 50-60 cyc; Double shielded; Net wt: 1 1/2 lb; #T120 1.50 ea.
10 for 13.00 100 for 100.00



SEND FOR LATEST CIRCULAR

TERMS:—All Prices F. O. B. Our Plant. Rated Firms Net 10 Days; All Others Remittance with Order. Orders Under \$10.00 Remittance with Order, Plus Approximate Shipping Charges (Overage Will Be Returned).

Cable address: UNIGENCOR, N. Y.

324 CANAL ST., N.Y.C., 13, N.Y. Walker 5-9642
Universal general corp.

TUBE CARTONS • STACKERS

Super gloss red & black, or plain glossy white. Both types with new safety partition that meet U. S. government specifications! Specify white or colored when ordering.

SIZE	FOR TUBE TYPE	PRICES		
		Quantity per case	Per case	Per 100
Miniature red & black 1" x 1" x 3"	6AU6, 6AL5, etc.	3000	\$27.00	\$1.00
Miniature glossy white		3000	27.00	1.00
GT red & black 1 1/4" x 1 3/4" x 3 3/4"	6SN7GT, 6W4GT, etc.	2000	22.50	1.25
GT glossy white		2000	22.50	1.25
Large GT red & black 1 1/2" x 1 1/2" x 4 1/4"	11A3, 6BQ6GT, etc.	1500	20.25	1.50
Large GT white		1500	20.25	1.50
G red & black 2" x 2" x 6"	5U4G, 6BQ6G, etc.	1000	18.00	2.00
G white		1000	18.00	2.00
Small Jumbo, white 3" x 3" x 7 1/2"	809, 866A, etc.	550	41.25	7.50
Large Jumbo, white 4" x 4" x 10"	813, 872A, etc.	300	27.00	10.00
Ministackers, white (holds 10 mintubes)		1000	13.50	1.50
GT stackers, white (holds 10 GT tubes)		1000	18.00	2.00
Carton Lot	Per Carton	Each		
144	12.90	1.00		

Lead sheaths for crystal diodes



CONSISTENTLY HIGH QUALITY ELECTRONIC TUBES

Guaranteed • Unused • Boxed
• SPECIALISTS IN JAN
WESTERN-ELECTRIC,
SUBMINIATURE, 5000/6000
SERIES AND RECEIVING TYPES

• Critical Types Lab Tested for Your Protection

0A4G	\$1.00	6J4W	2.50	811	3.00
0B3/VR90	.85	6SN7W	1.50	812A	3.50
0C3/VR105	.85	8D21	85.00	814	2.00
0D3/VR150	.85	RK28A	7.70	816	1.15
1B24	4.95	V45		838	1.00
1B24A	15.00	6AV5tron	525.00	853	5.00
1B26	1.50	RK68	1.00	851	9.50
1B32	2.00	RK61	2.75	860	3.50
1B35	6.50	OK40	25.00	866A	1.25
1B63A	22.50	OK61	25.00	872A	1.50
1B85	9.95	FG67	12.00	872A(G.E.)	2.75
1B86	7.75	RKR-72	.50	874(RCA)	.60
1N21B	1.50	OK151	35.00	876(RCA)	8.85
1N23E	1.50	90-NB		891	125.00
1N34A	.65	Amperex	7.90	902/902P1	6.00
1N38A	.85	FG98A	20.00	931A	3.00
1N48	.40	100P Surplus	5.00	932	1.25
1N56	.85	100TH Surp	6.75	958A	5.50
1N64	.70	OKL Surp	8.50	990T	137.50
1N65	.75	FG185	15.00	1500T Surp	120.00
1N69	.60	VT127A	2.50	1603	3.00
1N70	1.20	VXR130	.75	1619	.30
1N81	.90	FG172	45.00	5517	2.15
1P23	1.90	HF281A	27.50	5533/655	95.00
1P30	2.00	OK151	35.00	599T	8.00
WL1P41	1.25	707A	2.50	5634/SDB28E	7.00
2C39A	11.00	204A	00.00	5637	5.50
2C40	9.50	207	45.00	5638	8.00
2C43	7.75	211/VT4C	.50	5641	6.00
2C51	3.00	212E	15.00	5642	1.00
2C53	10.75	217A	45.00	5674	8.50
2D21W	1.00	245A	15.00	5651	2.25
2E30	1.60	246A	10.00	5654	1.55
2E35	1.95	249A	3.50	5656	6.50
2J36	35.00	251A WE)	45.00	5670	1.50
2J32	15.00	HK253	5.00	5672	1.25
2J37	10.00	268A	45.00	5676	1.00
2J54	15.00	272A	9.00	5678	1.15
2K25	22.50	274R	1.00	5686	2.00
2K28	28.50	275A	3.50	5687	3.00
2K45	65.00	276G	8.50	5691	5.50
2K55	17.50	287A	3.00	5692	5.25
3B23/RK22	4.00	GL289	3.50	5693	4.75
3B24	1.50	317H Surp.	10.75	5896	1.15
3B25	5.00	394TL Surp.	10.75	5702	2.00
3B25	5.00	311A	5.50	5704	1.90
3B27	3.50	311C	2.50	5718	4.25
3B28	6.00	313CA	2.95	5725/6AL5W	1.10
3B29	6.00	313CA	2.95	5726	3.00
3C23	7.50	327C	6.50	5744	.90
3C31/C1B	2.25	WE339A	14.00	5749	2.00
3C45	7.95	347A	3.25	5751	2.50
3D21A	4.50	350A (WE)	3.00	5763	1.10
3J30	45.00	350R	2.75	5780	250.00
3J31	45.00	WE355A	17.50	5787	5.75
3RP1	2.95	359A	2.00	5794	7.75
3BP11	7.00	391A	3.50	5795	250.00
3DP1	3.00	417A		5814	1.20
4B24	5.00	Klystron	3.50	5814A	2.00
4B28 6 Amp Rectifier	3.00	429A	8.75	5819	37.50
4E27	9.50	CK503AX	1.00	5829	2.00
4J21	77.50	GL559	.50	5840	5.00
4J36	75.00	GL562	50.00	5844	4.00
4J37	75.00	WL651/5852 50.00	5879	1.25	
4J63	7.00	WL-653B	110.00	5886	2.75
4-125A Surp	19.00	GL573	13.00	5890	35.00
4X150A	24.00	703A	1.25	5915	1.00
4X150A Surp	24.00	705A	.85	5922	6.50
4X150G	35.00	707A	4.00	5965	1.45
4X150F Surp	65.00	707B	5.00	5993	10.00
4-1000A	85.00	708A	2.00	6023	5.00
5B1P	3.75	715A	1.75	6073	1.65
5BP4	3.95	717A	.50	6097	1.50
5C22	29.95	721A	.75	6098	1.90
5D21	7.95	723A/B	9.50	6100	4.75
6D4	1.70	807A	4.50	6113	1.85
5LP5	10.00	726B	25.00	6183	275.00
5LP1	7.50	726C	35.00	6186	4.00
5LP5	10.00	750TL	write	6189	3.85
5MP1	10.00	800	2.00	8000	9.50
6BM6	22.50	803	2.00	8020	1.25
6D4	1.70	807A	4.50	8008	1.85
6F4	1.90	808	1.50	RC8A72A	4.00
6J4	1.95	809	2.25	8013A	3.60

WE STOCK MANY OTHERS... WRITE

Terms: F O B—N Y C—25% Deposit with order—or send full remittance to save C O D charges—D & B Rated Firms (F2 1/2 or Better) Net 10 days. CABLE: BARRYLECT, N. Y. TELEGRAPH: BARRY ELECTRONICS, FAX: N. Y. C.

DIRECTRON SELENIUM RECTIFIERS



Max. Amps.	FULL-WAVE BRIDGE TYPE					
	18VAC 14VDC	36VAC 28VDC	54VAC 42VDC	72VAC 56VDC	90VAC 63VDC	130VAC 100VDC
1	\$1.35	\$2.35	\$3.75	\$4.50	\$4.50	\$7.45
2	2.00	2.75	5.35	5.90	5.90	9.15
2 1/2-3	2.95	4.15	5.85	7.85	7.85	12.75
4	3.50	6.45	11.35	14.15	14.15	21.75
6	4.00	7.75	12.85	17.30	17.30	29.75
10	5.90	11.45	19.50	24.80	24.80	41.35
12	7.25	14.35	22.10	29.75	29.75	44.25
20	13.05	25.05	37.25	48.75	48.75	78.50
24	14.25	28.75	44.50	57.65	57.65	81.00
30	17.95	34.35	56.50	71.00	71.00	109.00
36	22.45	42.35	65.00	86.95	86.95	134.00
50	29.50	54.35	105.45	115.75	115.75	174.00
100	59.50	119.00				

We build other Selenium Rectifiers, Transformers, and Chokes to your specifications. Buy from the Direct Source for Quick Delivery.

NEW RECTIFIER TRANSFORMERS

Continuous Ratings 1 Amp. \$5.75
Pri: 115V, 60 cycles input 2 Amps. 6.75
SEC: 9, 12, 18, 24, and 36 4 Amps. 8.75
volts. 12 Amps. 16.65
24 Amps. 35.65
50 Amps. 59.00
100 Amps. 108.00

NEW RECTIFIER CHOKES

Continuous Ratings 1.5 ohm \$4.95
1 Amp. .1 Hy .9 ohm 5.95
2 Amps. .04 Hy .9 ohm 5.95
4 Amps. .07 Hy .6 ohm 7.95
12 Amps. .01 Hy .1 ohm 14.95
24 Amps. .004 Hy .025 ohm 29.95
50 Amps. .005 Hy .01 ohm 54.00

FILTER CAPACITORS

Capacity W. Voltage Each
500 MFD 200 V. \$1.95
500 MFD 50 V. .85
1000 MFD 15 V. .35
2000 MFD 50 V. 2.25

U. S. NAVY INFRA-RED SNOOPSCOPE/TELESCOPE

An ingenious infra-red device that lets you see in the dark. Powered by two ordinary type "D" flashlight cells, the unit is completely portable and independent of all other sources of power. Each scope is complete with lens, 1P25 viewing tube, focusing adjustment, hand and shoulder straps, special mount for fixed use, and waterproof rubberoid shoulder type carrying case. Very light and compact. Easy to use. Requires only standard light source with infra-red filter. Absolutely BRAND NEW! (Original cost to government over \$1,500.00)
RCA Model US/C-3 SNOOPER- \$160.00
SCOPE NET EACH.

SELSYN CLOSEOUT!

Only 200 pieces
115 volt, 60 cycle repeater selsyns. Track perfectly in pairs. Originally used as part of Sig. Corps remote indicator I-227-A. Made by Bendix. Type XV, CAL-11900A, No. 78386. Removed from equipment, all are clean and in guaranteed perfect appearance and operating condition. Will sell all or part. \$9.95 SPECIAL, NET EACH

BARRY

ELECTRONICS CORP.
Dept. 11-E
512 Broadway, N. Y. 12, N. Y.
Phone: Walker 5-7000

Calvert Electronics
INCORPORATED

The Switch is to CALVERT

LARGE STOCK OF TUBES

Receiving, Television, Transmitting, Special Purpose, Klystrons, Magnetrons, etc.

MORE THAN A MILLION TUBES IN STOCK AT ALL TIMES

SPECIAL PURPOSE

KC4	19.00	RK60/	861	7.50	
KCA-3	19.00	1641	864	.17	
1A04	.75	RK62	1.75	866A	1.25
1B24	4.45	RK65	7.45	872A	2.75
1B32	.44	RK72	.65	876	.75
1B35	3.25	RK73	.65	884	.77
1B56	14.00	101F W.E.	1.35	889R	65.00
1P23	.45	101L W.E.	.39	889RA	88.00
2C22	.37	V127A	17.00	891	77.00
2C33/		VT 127A	1.75	902PI	3.35
RX233A	.68	GL 152	10.00	931A	2.55
2C43	10.75	FG 172	17.50	954	.14
2C46	6.00	205B	.65	955	.24
2C51	3.25	207	55.00	CW-1089	88.00
2D21W	1.75	212A	2.45	DG-1254	5.50
2J26	4.75	215A W.E.	2.00	1616	.44
2J32	7.50	217C	3.75	1619	.22
2K31	65.00	249B	3.75	1625	.19
2K38	25.00	250R		1626	.19
2K45	55.00	Eimac	3.45	1629	.19
2K48	65.00	253A W.E.	3.45	1630	.55
2K56	55.00	254A W.E.	5.50	1632	.22
2X2/879	.22	274B W.E.	3.00	1680	.77
3A5	.22	312A W.E.	2.95	1846	55.00
3B4	1.00	322CA	7.45	VC1907	45.00
3B7	.35	375A W.E.	1.75	5517	1.75
3B24	1.25	374A W.E.	1.75	5637	5.00
3B24W	7.45	388A W.E.	1.75	5651	1.50
3B27	6.75	393A W.E.	4.50	5670	2.00
3C37B	25.00	394A	3.75	5672	.75
3CP151	2.00	407A W.E.	1.95	5678	.75
3DP152-A	3.50	408A W.E.	1.95	5687	2.75
3E29	8.45	416A	0	5691	5.00
3FP7A	3.75	421A W.E.	7.45	5692	6.75
3JP7	3.75	422A W.E.	4.45	5693	4.45
3RPI	9.00	446B	2.00	5702	1.45
4B23	10.00	464	2.25	5725	1.00
4E28	9.00	471A	2.00	CK5744	.77
4E27	9.00	WL-500	45.00	5751	2.75
4J25	19.00	WL-532A	.44	CK5784	2.25
4J31	75.00	615	.44	5849	7.50
4J32	75.00	WL-616	19.00	5949	45.00
4J33	75.00	WL-681	.19	5933	4.50
5A91	2.00	686	25.00	5964	.44
5B21	2.75	673	12.00	6005	1.75
5BP1	.99	705A	.65	6035	9.00
5BP4	1.75	707B	4.50	6038	3.35
5CP1	3.25	713A	.39	6096	1.00
5D21	6.45	715B	4.50	6099	1.75
5D23/		717A	.35	6101	1.35
RK65	7.45	721A	1.00	7193	.14
5D24	15.00	721B	5.50	8002R	25.00
5FP7	1.75	722A	.77	8011	.44
5HP1	3.75	723A/B	8.75	8012	1.95
5WP1	1.00	724B	1.77	8019	1.50
6AC7W	1.00	726C	25.00	8025	2.95
7BP7	2.75	730A	7.50	8025A	3.45
10Y	.19	802	3.25	9002	.65
12A6	.29	806	7.00	9006	.24
T20	2.00	807	1.35	3611A	.50
T220	2.00	813	12.00	D405N2	55.00
T21	2.00	826	.75		
23D4	.44	830B	1.00		
26C6	1.00	832	4.50		
30 Special	.22	832A	5.75		
36C6	1.00	843	.19	IN21	.25
FG32	1.99	842	2.25	IN23	.17
39/44	.10	843	.25	IN43	.77
T40	2.00	845	5.00	IN58A	1.25
HY40Z	2.00	851	12.00	IN75	1.35

RECEIVING TUBES

OZ4	.39	6K8G	.65	30	.75
1A7GT	.33	6S7G	.45	36	.22
2X2/879	.22	6SH7	.44	37	.10
6AC7	.44	6SJ7	.48	38	.10
6AG5	.44	6SK7	.44	39/44	.10
6AG7	.77	6SS7	.60	41	.10
6AK5	.44	6Y6G	.65	43	.40
6AQ5	.44	7A6	.22	46	.50
6B4G	.44	12A6	.22	71A	.40
6G6G	.50	12C8	.15	76	.39
6K7	.40	12K8	.44	77	.44
6F5	.22	12SL7G7	.44	89Y	.12
6F8G	.22	14A4	.33		
6K8	.75	26	.40		

CRYSTAL DIODES

FACILITIES FOR EXPORT PACKING — DELIVERY TO PIER. DEPT. EO

Calvert Electronics
INCORPORATED

59 Fourth Ave. New York 3, N. Y.
Cable Address: CALVERTRON

A BARGAIN FOR YOU in a . . .

SOLA *Constant Voltage*
TRANSFORMER

End Fluctuating Line Voltage

OVER 60% OFF . . .
the factory price of a 1-input 2,000 VA unit! And here's another bonus! This Air Forces 2,000 VA overstock, Sola Cat. No. 30768, has 4 inputs! 90-125 V., 190-250 V., 60 cy. or 50 cy. Isolated secondary is constant 115.0 V. ± 1% from no-load to full-load of 17.4 amp. So, if you choose, use it as a 220:115 V. step-down. And slash \$147.50 off the factory 1-input price!

Brand new in original wood box. 4 cu. ft. Ship. wt. 254 lbs. F.O.B. Pasco, Wash. Only. **\$97.50**

(EXPORTERS: Note choice of 50 cycles.)

THE M. R. COMPANY
P. O. Box 1220-B Beverly Hills, Calif.

MODEL AN/FRC-1 RADIO TRANSMITTERS RECEIVERS

Long Distance Top Performance



Designed for compactness. Phone CW—MCW. Operates from 90 to 230 Volt-50/60 Cycle. Comprises a complete radio installation for Airport Traffic Control, Ship to Shore, Point to Point and Similar Traffic. Contained Within a Medium Sized Cabinet. Frequency Range 1.5 mc to 12.5 mc with Stable Master Oscillator.

ASK FOR FOLDER AND PRICE
BRAND NEW—QUANTITY AVAILABLE 20

MOBACO, INC.
A. Van Brooms, President
375 Fairfield Ave. Stamford, Conn.

An Investment!

Productive advertising is an INVESTMENT rather than an EXPENDITURE.

"Searchlight" advertisers almost invariably report prompt and satisfactory results.

BE CONVINCED—send us your advertisement TODAY.

Address Classified Advertising Division
ELECTRONICS
330 W. 42nd St., New York 36, N. Y.

INDEX TO THE SEARCHLIGHT SECTION ADVERTISERS

Allied Electronics Sales	452
Alltronics	452
Amber Industrial Corp.	448
Arch Electronics Co.	440
Arrow Sales Inc.	452
Barry Electronics Corp.	449
B & C Distributors Co.	438
Blan	448
Calvert Electronics Inc.	450
Chase Electronic Supply Co.	446
C & H Sales	447
Communications Equipment Co.	443
Compass Electronics Supply Div. of	
Compass Communications Corp.	445
Cramer Electronics Inc.	452
Dixon, J. C.	446
Electronicraft Inc.	453
Empire Electronics Co.	452
Engineering Associates	440
Fair Radio Sales	444
Fay-Bill Distributing Co.	442
Fetherstonhaugh & Kent	438
Finnegan, H.	438
Green, Gould	448
Harjo Sales Co.	448
Hodgson Co., R. W.	438
Instrument Service Corp.	452
JSH Sales Co.	441
Lectronic Research Labs.	446
Legri S. Co., Inc.	452
Liberty Electronics Inc.	453
McNeal Electronic & Eqpt. Co.	440
Mobaco, Inc.	450
Mogull Co., A.	444
Monmouth Radio Labs.	440
M. R. Company	450
Nibur Sales Corp.	451
Photocon Sales	446
Radalab	444
Radio & Electronic Surplus	452
Radio Research Instrument Co.	448
Relay Sales	442
Rex Radio Supply Co.	438
Ruxur Electronics Corp.	451
Sanett, Bob	438
Semler Industries Inc.	438, 440
"Tab"	
Telemarine Communications Co.	448
Universal General Corp.	449
V & H Electronic Industries	452
V & H Radio & Electronics Supply	446
Western Engineers	439
Wilgreen Industries	442

This index is published as a convenience to the reader. Care is taken to make it accurate but Classified assumes no responsibility for errors or omissions.

Bargains in Brand New Surplus

Write for special quantity prices on starred* items

SPECIAL SWITCHES



SW 141 (A-C) DPST normally open with or without lock-in position on push button part of CD-318 cord set

★.34¢



SW 244 SPDT Antenna change switch square D Cat. No. 9320-962 SC #32K-9503 - 20 Bakelite Base 2x8x1/4

★.49¢

Sensitive MU-Switch 15A. 125 V. AC 15/32-32 threaded bushing SPST N.C.—.44 SPST N.O.—.49 DPOT—.69

OIL FILLED CAPACITORS

VOLTS	MFD	Price	VOLTS	MFD	Price
25KV	1.0	★49.95	1000	28.0	5.50
25KV	0.5	★39.95	1000	2.0	.69
25KV	0.1	14.95	600	10.	1.29
7.5KV	0.5	4.25	600	8	1.19
6KV	0.25	1.09	600	4	★.69
3KV	0.5	1.59	600	2	★.39
3KV	0.1	★1.19	600	1	★.19
2.5KV	2.0	★2.95	660AC	5	2.95
2KV	5.0	2.95	330AC	5	1.29
2KV	.25	.89			

MULTIPLE SECTION OIL CAPACITORS

10 Mfd 400 volts ★59c	9 1/2 Mfd 600 volts ★59c
Dual 5 mfd 3 term. button mount.	8 Section 2-2-2-1-1-.5-.5-.5 Rated by Western Electric at -50 to +85C will pass 1000 V. test at 40°C 4 3/4x4 3/4x1 1/2
Meets specs for 600 V operation at 40°C. 3 3/4x3 3/4x2	

Molded, Upright and Ceramic-Cased Mica Capacitors

.01 4LS 600WV	CM45B103J	.32
.02 4LST 600WV	CM50B203G	★.45
.001 A2L 2500WV	Thickness 1/16"	.49
.02 6S 2000WV		1.65
.0068 F2 3000WV		★1.35
.00015 Type 59 10,000WV	3Amp @ 1MC	★9.95

PULSE NETWORK SPECIAL ★\$2.95

Sprague 15-1-400-50 15 Kv 1.0 usec 400 P.P.S. 50 Ohm Z

Variable Transmitting Capacitor: 19 to 116mmfd 27 plates, .085" air gap. O/a dim. 4 3/4x3 1/2x2 1/4 SC# 3D 9019V-1 P/o Tuning Units TU-7A a TU-79 ★98c

OCTAL SOCKETS ★\$5.00 C

Johnson 122-128 steatite sockets; Amphenol 49-558, steatite ring mounting; Amphenol ceramic and mica filled 1 1/8 and 1 1/2 mounting centers.

**R
E
L
A
Y
S**

Allied BJ6D36 DPDT, 24VDC coil contacts rated 5 Amp @ 24VDC, or 115V AC. ★.79c
Allied BO 13D35 SPST Double break normally open 24V DC. Coil Silver contacts each rated 15 Amp @ 24V DC or 115V AC. ★.98¢
Autelco Jr Type 16 115V AC coil DPDT Snap Action contacts rated 15 Amp 115V, 5 Amp 230V. ★2.95
Cook #773 Standard Telephone Relay 900 ohm DC coil double arm 14 contacts 11A-1B-1C-1D 4 1/2x1 1/2x3 1/2H. ★1.09

COAXIAL CABLE

RG 9 B/U	★15.00 C. FT
PL 259 Plug	★29¢
M 359 Angle Adapter	★23¢

Power Rheostat famous make Model J 3000 Ohm 50 Watts. ★.79c
Potentiometer JLU 2000 Ohm 2w with lock nut ★.44¢

These are only a few of our specials; write us your requirements

ALL PRICES F.O.B. OUR WAREHOUSE
TERMS: Net 10 days to firms rated well in D.B. Others deposit or cash with order balance C.O.D. Please include postage.

RUXUR ELECTRONICS CORP

623 HUDSON ST., NEW YORK 14
Watkins 4-7260

Choice Microwave Materials
Recent Government Surplus Releases

Available now for your examination before purchase (no obligation)

Any of the components listed below will be mailed to you for examination (10 days). A Purchase order is not necessary. Address your request on company letterhead listing all materials you wish to examine.

- S band frequency meter, 2450 to 3400 mc, made by W. E., complete with calibration, requires meter and crystal diode \$55.00
- K band crystal mixer for IN-26 crystal 15.00
- X band search antenna complete with 2 motors and dish .. 40.00
- X band directional coupler, RG 52/U guide, type N take off, 20 db calibrated to .1 db 15.00
- S band crystal mixer, type J, tunable 15.00
- Wave guide below cut-off attenuator, 200 to 700 mc, calibrated 30 to 100 db 15.00
- S band coaxial test load, 1 watt, TPS-55P/BT, 50 ohms, Type N connector 12.00
- High pass Filter F-29/SPR-2, cut off 1000 mc, 50 ohms, Type N connector 12.00
- S band oscillator cavity with cut-off attenuator, 2300-2950 mc 25.00
- S band Standard Frequency Cavity, with crystal detector, Type N input and UHF output connector with 1N27 crystal 15.00
- S band attenuator, CN-29/AP, 20 db, type N connectors ... 10.00
- Rotary Joint, 7/8" coaxial, S band 15.00
- Antenna, pressurized, 7/8" coaxial, S band 10.00
- Butterfly Tuners, oscillator 110 to 330 mc 5.00
- Mixer, 80 to 300 mc 5.00
- X band thermistor mount, with thermistor, UG 39/U flange. 25.00
- X band Pick Up Horn, AT-48/UP, coaxial fitting 12.00
- 30 Mc IF Strip, Video and Audio Amplifier with power supply, 115 volts 60-2600 cps 65.00
- RF Power Meter, 1 to 700 Mc, 0-15 and 0-60 watt scales, ME 11A/U 95.00
- H Bend, RG-52/U guide with UG39/U and UG40/U flanges 90 degrees 10.00
- E Bend, RG-52/U guide with UG39/U and UG40/U flanges 90 degrees 10.00
- 90 Deg. Twist guide with UG39/U and UG40/U flanges 90 degrees 10.00
- 45 Deg. Twist guide with UG39/U and UG40/U flanges 90 degrees 10.00
- Dummy Loads X band, RG 51/U Guide, 250 watts ave. 40.00
- Dummy Loads X band, RG 52/U Guide, 200 watts ave. 40.00
- Dummy Loads S band, RG 48/U Guide, 700 watts ave. 90.00
- Dummy Loads L band, 6.66x3.41 Guide, 2000 watts ave. ... 300.00
- VSWR Amplifier, TAA-16, reads direct VSWR or Power Db 150.00
- Voltage Divider TS 89/AP, for high video pulses, up to 20.000 v 45.00
- P-4 Synchroscopes, used, as is 25.00

NIBUR SALES CORPORATION

P.O. BOX 811

RED BANK, N. J.

Phone RED BANK 60405

SELLING

Receivers
Transmitters
Radar
Special Purpose Tubes
Relays
Meters
Switches
Connectors
Rectifiers
Transformers
Motors & Generators
Wiring Cable
Instruments
and
All Electronic Components

WILL BUY ALL

New or Used

Leach Relay #5059-R
#5058
#5055
#5053-SM
#5053

Price Bros. Relay #10
Relay #5586
#5587

Antenna Switching Relay
Box # CBY 23049
BG-AN-198
BC -408

Tubes #53A
VT-127A
35T
WL-530

Highest prices paid for most all types of aircraft sparkplugs any condition

RADIO & ELECTRONIC SURPLUS

13933-9 BRUSH STREET
Detroit 3, Mich. TO 9-3403

Wholesale Only

Wholesale Only

ELECTRONICS

We buy and sell all types of aircraft electronic equipment. We have the largest, most complete stock on the coast of receivers, transmitters, and radar equipment — all checked and guaranteed. We own and operate our own overhaul plant. What are your needs?

ELECTRONIC TUBES:

We have most complete stock of late-type electronic tubes for broadcasting, industrial, military and ham use. Quotations on request.

ELECTRONIC INDUSTRIES

2033 WEST VENICE BLVD.
LOS ANGELES 6, CALIFORNIA

Send for free catalogue

Phone: Republic 5-0215

Cable Address: VHRAELECT

PULSE TRANSFORMER PT-3

TUBE BASE PLUG-IN TYPE

Similar characteristics to UX 7350. Precision-made. Two 100-turn and two 50-turn coils wound on high quality hypersil cores. Built into octal bakelite tube bases. Completely impregnated and sealed—humidity-resistant. Diagram on end disc of each unit provides versatility of application.

THESE PT-3 TRANSFORMERS may be used

- In Blocking Oscillator, Multivibrator and Scope Circuits.
- For Interstage coupling, impedance matching and isolation.
- Whenever accurate timing and triggering are essential.
- In circuit applications requiring the generation of low power and low voltage pulses.
- In circuits utilizing repetition rates from 0 to well over 1 MC and pulse widths from .03 microsecond.

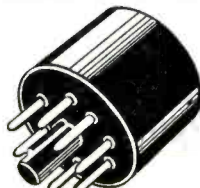

LOW INTRODUCTORY PRICE { Only \$5.95 ea.
2 for \$11.00

Cramer Electronics, Inc.
811 Boylston St., Boston 16, Mass. CO 7-4700
Write for Bulletin of late items.

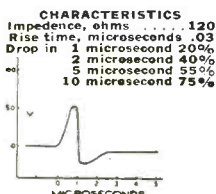
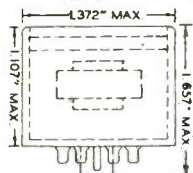
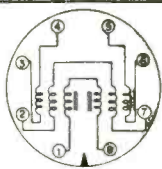

ALLIED ELECTRONIC SALES

THESE ARE ONLY A FEW SPECIAL VALUES FROM OUR HUGE STOCK OF TUBES —SCOPE TUBES, KLYSTRONS, SPECIAL PURPOSE, ETC. Query Us For Other Types.

JAN • NEW • UNUSED 1B24 . . . 4²⁵ SYLVANIA • WESTINGHOUSE	NEW • UNUSED 1Q22 . . . 35⁰⁰ WESTINGHOUSE	NEW 5718 . . . 2⁹⁵ SYLVANIA
NEW • UNUSED 1B35 . . . 4⁰⁰ BOMAC	NEW 5C22 . . . 20⁰⁰ SYLVANIA • KUTHE	NEW 5654 . . . 1⁵⁰ GEN. ELECTRIC

74 CORTLANDT ST., N. Y. 7, N. Y. BARCLAY 7-5839. Dept. E
F.O.R. N.Y.C. Rnted (D&B) Firms Open Account. Attractive Discounts To Quantity Buyers.

TIME DELAY RELAY

Haydon 115v 60 cy. adj. in 5 sec. steps to 40 sec. split mu sw. \$5.95. With 2 arms & 2 sw. \$8.95
PULSE xfmr Utah 1859-AA,3-50T Windings.\$3.95

Hundreds of other items, see ad in Buyers Guide Issue, write for listings.

EMPIRE ELECTRONICS COMPANY

409Q Ave. L Brooklyn 30, N. Y. Cloverdale 2-4000

ART-13 APR-4 BC-610-E

BC-348, BC-312, BC-342, TCS-12, BC-221, ARC-1, Dumont #241 Scope DY-17, Tele-type, Boehme Keyers

ALLTRONICS, Box 19, Boston 1, Mass.

Richmond 2-0048



Get Measured Value in any make, model, size, range, quantity at INSTRUMENT SERVICE. New or surplus Meters, Standard or Special Meters for electronic, aircraft, military, and ham requirements.

METER REPAIR

In Electronics everything must be under proper control. That's why servicing and overhaul of your instruments is vitally important. Our repair service is fully equipped to handle Weston, Lewis, Westinghouse, Liquidometer, Kollsman, Pioneer.

INSTRUMENT SERVICE

455 B. 67TH ST. ARVERNE, N. Y.
CAA No. 4264 Ltd. NEptune 4-8594

All Buyers: **RESISTORS** . . . **LEGRI S COMPANY**
391 Riverdale Ave. Yonkers 5, N. Y.

Phone: Yonkers 9-6000

HI-VOLT OIL CAPACITORS

Mfd.	KV	Price
.001	50	22.95
.01	5	2.50
.02	8	4.50
.02	20	6.75
.025	50	17.95
.025/.025	50	34.50
.1	3	1.75
.1	4.5	3.50
.135	7.5	6.95
OA2	50	29.50
.25	15	9.95
.25	20	15.95
.25	50	44.50
.5	25	39.50
1.	7.5	6.95
1.	15	29.50
1.	20	42.50
2.	5.5	9.50

SPECIAL!

PYRA-NOL FILLED CAPACI-TOR

Cat. No. 26F681

ONLY \$6.95



.02 mfd. 20,000 volts. 10 1/2 x 2 1/2 dia. in. A real value at only...\$6.75

TEST EQUIPMENT

FLUX-METER. Measures flux of magnetron magnets from 500 to 4000 gauss. New...\$14.95
FREQ.-METER TS-127/U. Range 375-725 Mcs. New with spare tubes and manual...\$34.50
PANADAPTER, AN/APA-10. For 115v., 60 cy. New with 80 page tech manual...\$97.50
400-500 Mc TEST OSC. TS-47/APR. New...\$149.50
FREQ-STANDARD. Telrad 18A. New...\$23.95
152-210 Mc RECEIVER. BC-1068A. 60 cy...\$29.50
RECEIVER MX-24/AR-1. New...\$97.50
PULSE TIMER. CUZ-50AGD. For 115/60/1. \$65.00
300-1600 Mc. OSCILLATOR AN/AIT-5. New...\$139.50
450-710 Mc. OSCILLATOR AN/APT-2. New...\$29.75
MODULATOR BC-1203. For 115v., 60 cy...\$125.00
MODULATOR BC-423B. Radiates 205Mc. pulsed sig. at 4,098 cps. New. 60 cy...\$49.50
PULSE ANALYZER. Airborne counter-measures model ID-59/APA-11. New...\$149.50
FREQ. METERS. LINK 230-D2. For testing mobile equip. One each 152-270-157, 530, 152, 390-157, 850, 152, 510-157, 770, 152, 630-157, 890, 35, 420-43, 420 Mc. Price per set...\$49.50
SIG. GEN. I-222A. 115-230 Mc., 8-15 Mc...\$89.50
20-250 Mc. FREQ. METER TS-174. P.O.R.
SIG. GEN. SQ-13/ARN. AM-PM 105-138 Mc. for aircraft loc. and glide slope tests...P.O.R.

AMPLIDYNES

5 AM21J7. Input 27 VDC @ 15 A. Output 60 VDC @ 2.5A. 4000 RPM. New...\$34.50
 5AM31N19A. Input 27 VDC @ 44 A. Output 60 VDC @ 8.8 A., 7500 RPM. New...\$23.50
 5AM31N18A. Input 27 VDC @ 44 A. Output 60 VDC @ 8.8 A., 8300 RPM. New...\$12.50

INVERTERS

Leland Elec. C. PE206A. Input: 28DC at 38 Amp. Output: 30V, 800 Cy., 1 Ph., 485V. New...\$16.50
 PE218H. Input: 28DC. Output: 115, 400 cy., 1 Ph., 1.5 KV. New...\$32.50
 G.E. 5AS131J11A. Input: 28DC. Output: 115, 400 cy., 1 Ph., 1.5 KVA. Regulated. New...\$89.50

DYNAMOTORS

Navy type CA10-21144A. Input: 105 to 130 VDC. Output: either 26 VDC at 20 amps, or 13 VDC at 40 amps. Radio filtered and complete with line switch. New...\$69.50

SMALL DC MOTORS

G.E. 5BA5012A. Armature 6V. VDC at 8.3 Amps. Field 27.5 VDC at 2.3A. RPM 4000. H.P. 0.5. New...\$27.50
 Oster E-7-5. 27.5DC. 1/20 HP. 3600 RPM. Shunt Wound. New...\$9.50

9 CONDUCTOR CABLE

Army spec. CO-215 Weatherproof 9 Cond. No. 20 AWG stranded tinned copper, plastic ins., colored coded, double vinyl jackets with tinned copper braid between. Dia. 9/16" made by G.E. Available 1000, 1500, 2000 ft. Price 10c. Sample 100 ft. Coil...\$10.00

NEW SCR-522A EQUIPMENT

Complete BC-624C receivers and BC-625AM Transmitters including mounting racks, plug, connectors, dynamotor. Brand new equipment with instruction manuals. Write for full details

NEW REPAIR PARTS FOR BC-348

(Models H, K, L, R only)

4 gang tuning capacitor...\$ 3.95
 Aluminum front panel...\$ 3.75
 1st, 2nd, 3rd, and 4th I.F. transformer, assy... Each \$ 2.00
 Crystal filter assy inc. 915 Kc. Crystal...\$ 6.50
 C.W. Oscillator assembly...\$ 2.00
 R.F. Unit Assembly in can...\$12.50
 Dual Volume Control...\$ 2.75
 Spinner, tuning knob...\$.50
 Ant., RF, Det. and Osc. coils for bands 1 to 6. Per Band...\$ 2.00
 Complete Dial assembly...\$16.50

10 CM RADAR ANTENNAS

SO-1 (10W) assembly, with reflector, waveguide nozzle and drive motor...\$279.50
 SO-3 (3CM) Surface Search type with reflector and drive motor, but less plumbing...\$99.50
 SO-13 (10CM) complete assembly with 24" dish, dipole, drive motor and gearing...\$49.50

RA38 RECTIFIER

Variable output 0-15000 V DC @ 500 MA. Input 115V 60 cy 1 ph. Size 63 x 53 x 56 in. Write for detailed information

HIGH POT TRANSFORMER

Westinghouse. Pri: 115, 60 cy. Sec: 15,000V C.T., @ .060A. C.T. underground. Excellent for high potting tests. Size OA 12H x 8 3/4W x 9 3/4D. Weight 67 lbs. Fully enclosed steel case. Price...\$29.50

6 KVA. STEPDOWN TRANSFORMER

G. E. Step-Down. 6KVA. Pri: 230/460. Sec: 115/225, 60 Cy. Size: 10 1/2" x 9 1/2" Weight 225 lbs. Navy grey finish. Integral junction box and mounting brackets...\$49.50

Phone: DEerfield 7-0044

ELECTRONICRAFT
 27 MILBURN ST. BRONXVILLE 8, N. Y.

NEW YORK'S RADIO TUBE EXCHANGE

NEW TUBES

Standard brands. First grade only. No pull outs. No rejects. No rebrands. At lowest prices. Wholesale and export only.

Type	Price	Type	Price	Type	Price	Type	Price	Type	Price
OA3	\$1.00	2J3A	\$6.00	3E29	\$1.50	12AP4	\$5.00	371B	\$1.50
OB2	.99	2J3B	8.95	2Q1P	7.00	14DP7A	59.00	383A	4.50
OB3	1.10	2J39	8.59	5J21	5.00	LM16	200.00	388A	1.80
OC3	.96	2J40	29.00	4I26	5.40	3F	1.75	393A	7.50
OD2	.89	2J42	135.00	4C27	10.00	16R	.75	394A	3.95
C1B	2.95	2J19	60.00	4C28	35.00	NF18	.59	AMX408U	.50
1R22	1.50	2J50	55.00	4J25	50.00	KY21A	8.25	434A	15.00
1R23	6.95	2J58	150.00	4J26	50.00	RK21	2.50	446A	1.95
1R24	9.00	2J56	110.00	4J27	50.00	RK21	8.00	448R	3.95
1R24	1.75	2J61	20.00	4J28	50.00	KH24G	1.50	450TL	45.00
1R27	15.00	2J61A	23.00	4J29	50.00	2ST	2.95	450TH	52.50
1R34	35.00	2J62	13.00	4J30	30.00	HR39	1.75	454A	7.50
1R60	23.00	2K22	29.00	4J31	150.00	HF60	1.75	471A	1.25
1R65	35.00	2K25	13.50	4J32	150.00	HK54	4.50	627	18.00
1R60	35.00	2K26	68.00	4J33	150.00	HK79	1.00	WL530	23.00
1N21	.55	2K28	35.00	4J34	100.00	RK73	1.00	WL631	22.50
1N21A	.95	2K29	38.00	4J35	150.00	FG95	19.95	WL533	15.00
1N21B	1.50	2K34A	75.00	4J36	150.00	100TH	7.95	HK654	35.00
1N21C	12.50	2K29	140.00	4J37	150.00	122A	1.75	700A/D	10.00
1N22	.66	2K30	295.00	4J39	150.00	2063A	3.75	701A	4.50
1N23	.90	2K42	180.00	4J40	150.00	211	.95	704A	1.95
1N23A	.90	2K43	189.00	4J41	150.00	217C	12.00	708A	2.75
1N23B	1.50	2K44	180.00	4J42	150.00	242C	10.90	709	8.95
1N23C	7.50	2K46	80.00	4J51	190.00	244C	9.50	EY	25.00
1N25	4.50	2K48	85.00	4J52	225.00	249C	4.25	707A	5.75
1N26	6.75	2K50	295.00	4J53	150.00	250TH	19.95	707B	6.75
1N27	3.50	2K54	35.00	5HP1	3.95	260TL	19.95	714AY	36.00
1N34A	.70	2K55	25.00	5HP2A	12.00	262A	3.00	718A	4.50
1N34	1.00	2K66	72.00	5HP4	3.95	275B	1.00	718B	9.00
1N43	2.25	3AP1A	10.00	6CP1	7.50	304TH	10.00	715C	15.00
1P23	75.00	3DP1	7.20	6CP2	9.95	304TL	10.00	717A	1.50
2C39A	13.50	3R14	15.00	6CP3A	18.00	307A	3.50	718B	9.00
3C40	12.00	3R25	5.50	6CP12	15.00	310A	4.95	720V/A	15.00
2C43	14.50	3R28	5.00	8T21	10.00	310B	4.95	GY	50.00
2C44	.60	3R29	295.00	5J11	27.50	311A	6.50	721A	1.50
2C46	7.50	EL3C	5.50	5J12	19.50	312A	3.50	721B	7.50
2D29	.99	3C22	75.00	5J14	27.50	322A	15.00	723A/B	18.00
2J27	12.00	3C24	1.75	6J23	25.00	327A	3.75	719A	1.95
2J28	9.00	3C31	2.95	6L11A	25.00	325A	6.75	724B	7.25
2J29	15.00	3DP1	7.50	5SP7	96.00	360A	4.50	725A	18.00
2J30	12.00	3DP1A	10.00	6F6	12.00	350B	5.95	726A	18.00
2J31	24.00	3DP1A	10.00	6G7	5.00	HK354C	15.00	726B	45.00
2J32	29.00	62	10.00	7HP7	5.00	357A	15.00	728C	45.00
2J33	32.00	3EP1	5.00	7DP4	9.00	368AS	4.95	730A	22.50

VARIOUS 5000 AND 6000 SERIES OF NEW PRODUCTION

5820	475.00
5826	450.00
8012	2.00
8012A	2.50
8013	3.00
8013A	3.50
8019	1.75
8025	3.75
P18365	96.00
9001	3.52
9002	.90
9003	1.25
9004	.35
9005	2.75
9006	2.25

THOUSANDS OF OTHER TUBES

Special! TS45 X BAND GENERATOR - \$99.00

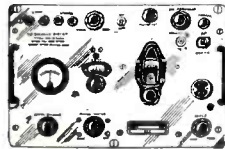

NEW

TS-147 B AND C/UP TEST SET SIGNAL GENERATOR

Hard-to-get X-Band Now Available

Test Set TS 147 UP is a portable Microwave Signal Generator designed for testing and adjusting beacon equipment and radar systems which operate within the frequency range of 8500 MC to 9600 MC.

NEW UNUSED SURPLUS TS 259 K BAND 23400-24500 MEGACYCLES SIGNAL GENERATOR

NEW MICROWAVE TEST EQUIPMENT TS148/UP SPECTRUM ANALYZER

Field type X Band Spectrum Analyzer. Band 8430-9580 Megacycles.

Will Check Frequency and Operation of various X Band equipment such as Radar Magnetrons, Klystrons, TR Boxes. It will also measure pulse width, c-w spectrum width and Q or resonant cavities. Will also check frequency of signal generators in the X band. Can also be used as frequency modulated Signal Generator etc. Available new complete with all accessories, in carrying case.

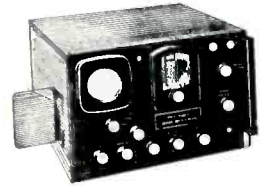

SPECIAL! 5,000 V. POWER SUPPLY

For IP25 Infrared Image Converter from 3 V. Battery Source.

\$990

OTHER TEST EQUIPMENT USED CHECKED OUT, SURPLUS

TSK1/SE	T35/AP	TS108	TS226	Surplus Equip.
TS3A/AP	TS36/AP	TS110/AP	TS239A-TS239C	APA10
RF4/AP	1-96A	TS125/AP	TS251	APA38
TS12/AP	TS-45	TS126/AP	TS258	APS 3 APS 4
TS13/AP	TS47/APR	TS147	TS270	APR4
TS14/AP	TS49/AP	TS174/AP	TF990/1	APRA
TS33/AP	TS100	TS175/AP	834	APT2-APTS
TS34/AP	TS102A/AP	TS182		

You Can Reach Us on TWXNY1-3235

Large quantities of quartz crystals mounted and unmounted.

Crystal Holders: FT243, FT171B others.

Quartz Crystal Comparators.

North American Philips Fluoroscopes Type 80.

Large quantity of Polystyrene beaded coaxial cable.



Phone: WOrth 4-8262

LIBERTY ELECTRONICS, INC.

135 LIBERTY STREET NEW YORK 6, N. Y.

Cables: TELSERUP

Minimum Order 25 Dollars

"TAB"

THAT'S A BUY

THOR ELECTRIC DRILLS
 201J 1/2" Electric Speed Drill w/Jacob chuck. 2400 RPM
 400J 3/4" Electric Speed Drill w/Jacob chuck. 650 RPM
 115VAC/DC. \$29.95

FENWAL THERMOSWITCH
 #17300-24 Precision Adjustable Knob Air Control -100 to -400°F/10A/115VAC
 Special @ \$4.95 ea; 2/58

LATEST G.E. PHONO CARTRIDGES
 Original Boxed, \$, \$, \$, Back Gtd

RPX050A .001 & .003. 56.98
 RPX052A Gold Treasure. 19.98
 RPX053A Gold Treasure. 28.98
 RPX054A Single (S). 003. 5.25
 RPX041A Single (S). 001. 5.25

"TAB" HI-FI SPEAKERS
 Inbuilt network 2 wires needed for HF & LF Response. Famous HI-FI mfg. 15" Coaxial PM Model P25C \$19.50
 12" Coaxial PM & 3 1/2" Tweeter. 12W/45-15000 cy. \$12.75 3 for \$35
 8" Coaxial PM & 2 1/4" TW. 8 Watts/70-15K C Model P8C. \$7.98 2/515

TRANSFORMERS
 ALL 115V 60 CYC INPUT
 2500V/20MA, 6.3V/8A, 2.5V/1.75A
 490A12 Scope Replmt. \$7.98
 1500V/35MA, 6.3V/3CT/2A, 6.3VCT/10A, 2.5VCT/6A. \$7.95
 900V/35MA, 6.3V/3CT/2A. \$7.95
 1800V DBLR TWO 2X2 FIL WNDGS. \$11.98
 778CT/200MA, 5V/3A, 6.3VCT/2A. \$4.98
 5A THORDARON. \$4.98 2 for \$9; 6 for \$24
 770V/2.5MA, 2.5V/3A, HVINS HVMSLD includes FILTHER PARTS 4/aceps. \$3.99 2 for \$6.00
 500VCT/250MA, 6.3V/3CT/2A, 6.3VCT/10A, 2.5VCT/6A. \$4.50 2 for \$8.00
 420VCT/90MA, 6.3V/1.9A, W/INPUTS 6, 12, 24, 115VDC & 115 & 230 VAC. \$11.49

MICA CONDENSERS

MFD	WVDC	Price
.02	600	59c/100/\$50
.01	1200	43c/100/\$32
.001	1200	20c/100/\$15
.002	1200	25c/100/\$21
.015	2500	\$1.00/100
.002	2500	75c/100/\$69

CIRCUIT BREAKERS
 Heinmann Magn. Bkrs. Ass'd: 3, 5, 7, 9, 10, 12, 30, 40, 80, @ \$1.98 ea. 12/\$250/\$575
 Sd. D & CH Toggle Sw. \$4.24
 Amps: 5, 10, 15, 20, 25, 35, 50, 75
 Kilowatt Thermal Push Button Bkrs. Amps: 5, 10, 15, 30, 35 @ \$3.50
 10/\$7.98
 Ass'd One Each Twelve Types @ \$9

TUBES

"TAB" TESTED INSPECTED GUARANTEED!!!

OA2 .574	4J30 .99.55	HY615 .46	56B3 .1.06	5950 .6.45
OB2 .64	4J52 .64.90	704A .98	5672 .1.55	5965 .1.75
OB3/VR90 .84	4X150A .36.00	705A .98	5676 .1.55	6027 .179.95
OC3/V105 .82	5Y21 .25.50	710A .98	5686 .2.39	6072 .3.99
OD3/V150 .78	5D21 .9.48	715B .11.90	5687 .3.59	6080 .5.99
1AD4 .3.95	5U4G .46	717A .35	5692 .6.48	6099 .1.55
1A2 .1.65	6AN5 .7.51	721A .98	5693 .5.45	6101 .1.55
1A2X .1.25	6AS6 .1.60	723AB .9.98	CK5694 .3.70	6110 .6.55
1B3 .1.66	6AS7G .2.98	724A .2.94	CK5697 .3.70	CK6111 .8.95
1B24 .4.98	6J6 .46	725A .96	CK5702 .2.50	6119 .6.45
1B46 .1.88	6SN7 .58	725B .4.49	5704 .2.25	6121 .9.00
1C13 .4.50	6X4GT .56	807 .1.00	5713 .173.50	GL6136 .1.99
1D21 .3.49	6X4 .42	807Y .4.98	5718 .5.99	6146 .4.87
1Q13 .150.00	7C25 .125.00	814 .2.48	5719 .5.99	6164 .64.95
1X2A .62	8D21 .95.00	815 .3.99	5721 .189.55	6192 .49.99
2C39A .16.90	12AU7 .54	829B .8.49	5722 .6.39	6201 .3.99
2C51 .2.50	12AX7 .58	832A .5.49	GL5727 .1.77	6270 .199.95
2D21 .75	6F17 .3.01	864 .3.44	5732 .3.94	6271 .159.95
2E22 .1.89	19B6G .1.38	927 .1.36	5736 .159.95	6273 .199.95
2E24 .2.48	24C .1.96	954 .1.55	5744 .2.39	8005 .4.97
2E26 .3.78	HK24 .4.90	955 .65	5749 .1.72	8012 .1.09
2E32 .2.07	35Z5 .46	956 .62	5750 .3.10	8013 .4.91
2E43 .1.49	7Z40 .4.49	957 .51	5751 .3.09	8014A .50.15
2J30 .50.50	50L6 .60	CK1005 .56	5764 .55.99	8020 .2.95
2J42 .99.50	71A .74	1612 .1.98	5765 .55.99	8025A .2.95
2K25 .23.88	HY69 .5.49	1613 .1.27	5766 .298.00	9007 .3.86
2K28 .29.98	QK155 .699.99	1616 .79	CK5783 .5.55	9002 .96
2K29 Q .30	QK202 .99.99	1619 .34	CK5787 .4.95	9003 .98
2K30 .130.00	203A .7.38	1620 .5.01	5794 .5.99	9006 .15
2K33 .219.48	215 .10.35	1625 .44	5812 .2.99	
2K39 .0	230A .9.52	1626 .46	5814 .1.28	
2L11 .175.00	250R .2.92	1629 .22	5819 .49.99	3BP1A .5.55
2K42 .149.55	HM25A .18.00	1632 .63	5820 .69.00	3CP151 .5.98
2K43 .130.00	250T13 .35.00	1633 .98	5823 .1.25	3D1 .7.94
2K44 .150.00	304T .15.00	1642 .20	5825 .11.99	3D1A .6.80
2K48 .110.00	304T17 .15.00	1644 .99	5828 .6.70	3EP1 .4.71
2K50 .315.00	316A .48	1850A .99.00	5840 .5.05	3EP2 .1.91
2P23 .298.00	388A .1.98	2050 .98	5841 .7.98	3FP7A .6.91
3824W .8.48	394A .1.96	2050W .2.48	5842 .11.00	3GP1 .1.91
3C22 .72.50	434A .3.94	2051 .68	5814 .1.00	5BP1 .1.95
3C24 .3.98	446B .2.98	5514 .4.69	5852 .7.57	5CP1A .14.49
3D21A .7.99	450T17 .75.49	5516 .5.51	5857 .59.50	5D1 .3.91
3P23 .325.00	500A .2.05	5517 .5.94	5858 .144.99	5HP1 .3.91
3X2500A .125.00	512AX .1.35	5586 .150.25	CK5875 .2.05	5IP1 .14.95
4-625A .19.49	531D X .1.89	5588 .119.99	5876 .12.49	5L1 .9.91
4-125A .19.09	538D X .1.55	5617 .1.59	5879 .1.59	5LP1 .100.00
4B23 .16.98	539D X .2.50	5641 .6.59	5893 .7.25	5P1 .10.50
4B27 .4.98	540 X .2.50	5642 .6.59	5894 .7.40	5P2 .10.50
4C35 .16.95	571AX .4.45	5654 .1.72	5927 .89.45	
4Z26 .79.55	608CX .97	5656 .9.98	5932 .5.00	

NEW SONIC SOUND GENERATOR
 115 VAC Input
 Cleans! Agitates!
 Washers & Mixes
 "TAB" SPECIAL \$19.99
 Write For Complete Details

\$1.25 ea.
 Lots of 24
\$1.50 Ea.
 Sold Singly
\$1.79 Ea. Any Assort'mt

NEW!! HI SENSITIVITY
 6KV DC & AC
 27 Range
MULTITESTER
 (Not a Kit)
"TAB" \$21.95 ea.
 IN LOTS OF 3

A complete precision test instrument. 20,000 Ohms per Volt DC, 10,000 Ohms p/v AC. 38 microampere movement. 8 easy to read scales—D 0-50, 120, 600, 1200, 6000 Volts. AC 0-6, 30, 120, 600, 1200, 12000 Volts. Current 0-60 ma, 6, 60, 600 ma. Resistance 0-8K, 80K, 800K, 8 megohms. Decibels Cal 600 ohm -20 to +6, 20, 34, 46, 60 DBs. Capacity 250 ufd to 10 ufd. Inductance 10 to 1000 millihenry. Hi accuracy, variable, 1% Precision Resistors. Scale 3", Plastic engraved panel, Rugged metal case. LxH 4 1/2" x 6 3/4" x 2 1/4". Complete w/batteries & leads. RF Diode Probe included for signal measurement. Ship. wt. 4lbs.
"TAB" SPECIAL \$22.95 ea.
HV PROBE, 30,000 Volts \$5.95 ea.

NEW MINIATURE PM MOTOR
MINIATURE DIEHL PM MOTOR
 Type F45-21, RPM 10,000/27.5VDC
 Excellent mtr for Fan cooling. "TAB" Special @ \$2.95 12 for \$30.00
"TAB" Special \$2.00 ea. 2 for \$30
 Same except Sperry part #709832 only one bellows actuated resistor. Special \$12 ea. 2 for \$20
HAMS, INDUSTRIAL-COOL THAT TUBE!
 Diehl Miniature mtr & Fan. \$3.95; 12/\$42

SPECIAL "TAB" BUYS
 Giannini Density Unit mfg. for Sperry part #672340, consists twin Allimeter Bellows actuating Precision Potentiometers. Temp. comp. cov. over 2000° "TAB" Special \$20 ea. 2 for \$30
 Same except Sperry part #709832 only one bellows actuated resistor. Special \$12 ea. 2 for \$20
Bourman Precision Trimpot 20,000 Ohms. Special @ \$3; 4 for \$10

NEW MINIATURE METER
 O-1 Milliamp
 Precision Jeweled D'Arsonval Mvt. Better than 2% accy. Headable low 1/4" scale. 20 divisions. Rugged. Well mounted. Bakelite cased. Front Sn. or Rear Round Face mtr. Mounts 1 1/4" hole. 4 screws 1/4" extra. Not aslipin.
 Data Sheet for shunt current ranges
"TAB" SPECIAL \$3.85; 2 for \$7.00

PLANETARY DRIVE
 5:1 & 1:1 RATIO
 Reg. \$20.00 "TAB" @ \$2 SPECIAL \$13.00 3 for \$52

PARTS CABINETS
HEAVY GAUGE STEEL
 50 Draw 34 1/2 H, 18 W, 9" L Draw 3W
 2 1/2 H, 8" L, 6 1/2 W. Spec. \$35
 100 Draw 36 H, 18 W, 13 1/2 L. Spec. \$35
 24 H Draw 37 1/2, 18 W, 14" L Draw 3H
 9 W, 12" L 120 lbs. "TAB" \$34

CRAY TUBES

3BP1A .555	3CP151 .598	3D1 .794	3D1A .680	3EP1 .471	3EP2 .191	3FP7A .691	3GP1 .191
5BP1 .195	5CP1A .149	5D1 .391	5HP1 .149	5L1 .991	5LP1 .100	5P1 .105	5P2 .105

THAT'S A BUY
 Dep't 11E5 111 Liberty St., New York 6, N. Y., U.S.A.

NEW "TABTRON" SELENIUM RECTIFIERS

ENGINEERED FOR INDUSTRY

"TAB" manufactures power rectifiers to your specifications. From one amp up to and above 1000 amps, convection or fan cooled, single or 3 phase. "NEMA" & JAN. Specs. Write for catalog.

FULL WAVE BRIDGE • DATED & ONE YEAR GTD

Max Amp	18VAC	36VAC	54VAC	72VAC	130VAC	266VAC	Ctrl Taps	3 Phase	Bridges
	14VDC	28VDC	42VDC	56VDC	100VDC	217VDC	AC-DC	120VAC	240VDC
1	51.30	\$2.30	53.70	54.45	57.40	\$22.25	52.10	\$14.50	\$28.95
2	1.95	4.10	5.30	5.85	6.10	28.85	2.30	5.30	30.80
3	2.90	4.10	5.75	7.80	12.70	36.85	2.65	17.40	33.50
4	3.45	6.40	11.10	14.30	21.70	38.85	2.95	18.50	36.95
6	3.95	7.70	12.35	17.25	29.65	38.85	3.25	20.50	39.85
10	5.85	11.35	19.20	24.65	41.10	84.85	4.75	36.30	71.95
12	7.20	14.25	21.75	28.75	43.75	99.85	5.95	41.50	81.95
20	12.95	24.85	36.85	47.25	77.00	160.85	7.95	50.90	87.95
24	14.05	28.55	43.25	56.00	78.25	190.85	9.95	89.90	159.95
30	17.75	33.50	55.50	69.00	106.50	235.85	Q	117.90	225.95
36	22.10	41.50	64.75	84.25	131.00	295.85	14.95	134.90	269.95
50	29.40	54.00	97.35	106.35	171.00	405.35	23.95	179.90	359.95

RECTIFIER & XFMR COMBO, Up to 28VDC at 24 Amps Cont. Duty. \$60

WRITE FOR OUR NEW RECTIFIER & POWER SUPPLY CATALOG PR655

"TABTRAN" Rectifier Xfms
 Sec'd Volts (DUAL) 18-15-0-0-9-0-15-18V
 6 or 12V DC Power Supply Full Wave Rectification 6000MFD Condenser Filter Transformer 115V/60cy Output 6.3 or 12.6V
 Model D2CF (2 amp) \$12.98
 Model SDCF (5 amp) \$29.95
 SDCF ACC/5 amp/1% Ripple \$38.95

Heavy Duty Battery "Fast" Charger Rectifier
 13-0-13V(CT) 100 Amp Fan Cooled 6 or 24 Amp DC Fan Cooled. Rep't m't Booster Charger. \$10; 3 for \$27
 Model CR16 16-0-16V(CT) Fan Cooled for 12V/60A and 6V/100A Booster Chargers. Model CR30 \$11; 3 for \$30

"TABTRAN" Rectifier Chokes

CR6001/1 Amp/0.1 HY/1.4 Ohm. \$4.50; 2 for \$8
 CR6002/2 Amp/0.1 HY/67 Ohm. \$5.75; 2 for \$11
 CR6003/5 Amp/0.1 HY/9 Ohm. \$7.90; 2 for \$15
 CR6004/12 Amp/0.1 HY/3 Ohm. \$14.50; 2 for \$28
 CR6005/24 Amp/0.04 HY/0.025 Ohm. \$29.50; 2 for \$58

DISCOUNTS TO INDUSTRIALS, SCHOOLS & COLLEGES

230 to 115V Autotransformers

For 220V/50cy Input. To 110-120V or Step up. With Cord, Plug & Receptacle. \$2.55
 TPA050/50W. 3.65
 TPA075/75W. 4.00
 TPA100/100W. 4.00
 TPA150/150W. 6.75
 TPA200/200W. 6.75
 TPA300/300W. 8.25
 TPA500/500W. 11.75
 Model 12 Amp/1000 Watts 1 KW TPA1800/1500W \$22.50; TPA2000/2KW \$34
 * Less Cord Plug & Receptacle.

New Quality VOLTAGE REGULATOR

\$ \$ Popularly Priced \$ \$
ONLY \$16.98
 Line Voltage Stabilizer
 Stabilizes line voltage within plus or minus 3% regardless of VOLTAGE & FREQ. shift. Ideal for INDUSTRIAL, LAB or TV & RADIO use. Insures built-in strength & trace of TV picture regardless of line voltage. Automatically operated. regulator turns on & off with set or equipment. **TROUBLE FREE, QUIET**, needs no adjustment. Universal Use—from 100 to 300 Watts. Input 100-125V/Output 115V line or more. Data. Sold on "TAB" Money Back GUARANTEE. ORDER SIX ADDITIONAL 10% DISCOUNT

New Variable 0 to 6 & 12 Volt/12 Amp

DC POWER SUPPLY
 Battery Eliminator Charger
 Model RR Pilot Aircraft Marine or any DC Reg. Extra Heavy Selenium Rectifier, 2 Meters V. & A. Dcnd for Cont. Service
 and up to 30 Amp intermittent
 Output 115V line or more. Data.
SPECIAL \$29.95

FILTER CAPACITORS

CE156M 600MFD 15V \$1.25; 2 for \$2
 CE630M 3000MFD 50V \$3.98; 2 for \$7

INFRARED SNOOPSCOPE

SEE IN DARK TUBE
 Image-Converter Tube Hi-Sensitivity
 Willemite screen—Resolution up to 800.
 Output 115V line or more. Data.
"TAB" Special \$6.98; 2 for \$11
 Snooperscope Pwr Supply
 1800VDC/35MA. Using Doubler
 Crlt. Transformer Rectifiers Sockets Restorator, Capacit. and Diagram 115V/60cy Oper. \$6.98

POCKET AC-DC Multitester

"TAB" \$9.45 ea
 Lots of 3

Hi-accuracy precision VOM-1000 Ohms per V. Reads AC & DC Volts 0.5, 25, 250, 1000V. DCMA: 0.1, 10, 100M. Ohms 0.1 to 100K. Size 1 1/2" x 4 1/2" x 3 1/2". Test Leads. Sold Singly \$9.95; (plus 40c shipping)

WRITE FOR BARGAIN FLYER \$ \$ Real Money Savers \$ \$

PHOTOFLASH & STROBE LAMPS

"TAB" W-See

No.	Replaces	Max	Each
TWL	FA 104/PT118	150	\$5.98
21V	Anglo 580/200	120	7.98
28ST	GE FT 210	200	9.98
THVA	SYLV. 4330	200	9.98
VAXA	D400	200	10.50
TDX	DC/250 350	150	10.00
353GTO	PT 505	200	49.95

FRAGILE OIL LOG VOLT FLASH \$1.47
525MFD/450VDC/53 W soda COND new low leakage famous mfg. \$8; 2/515

...or Your
Regular Product

If Your
Government
Contract . . .

Requires
MANUALS

*Call in the
McGraw-Hill
Technical
Writing
Service*

- OPERATION
- SERVICE
- OVERHAUL
- PARTS CATALOG
- TRAINING

Whether you need one or a set of manuals written and illustrated precisely to meet Government specifications or whether your products are such that instructions on their proper installation, operation, and service must be provided — Technical Writing Service can do the job for you . . . efficiently . . . effectively . . . economically. Technical knowledge and writing skill are the keynotes of our service.

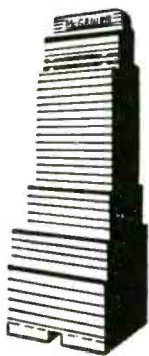

Write or Phone

TECHNICAL WRITING SERVICE
McGraw-Hill Book Company, Inc.
330 West 42nd Street
New York 36, New York

Tel: LONgacre 4-3000

Electrical Testing Laboratories, Inc.	212
Electro Data Corp.	396
Electro Impulse Laboratory	457
Electro Motive Mfg. Co., Inc.	103
Electro-Pulse, Inc.	349
Electro-Snap Switch & Mfg. Co.	71
Electro Tec Corporation	273
Electronic Instrument Co., Inc. (EICO)	381
Emerson & Cumming Inc.	316
Empire Devices Products Corp.	290
Engineering Co., The	369
Erie Resistor Corp.	202

Fairchild Camera & Instrument Corp.	196
Fairchild Controls Corp A sub of Fairchild Camera & Instrument Corp.	209
Fairchild Engine & Airplane Corp.	314
Fansteel Metallurgical Corp.	336, 337
Farnsworth Electronics Company	117
Federal Telephone & Radio Co.	183
Film Capacitors, Inc.	357
Filtron Company, Inc.	109
Five Star Co.	399
Ford Instrument Co.	344
Formica Co.	51
Freed Transformer. Co., Inc.	281
Frenchtown Porcelain Co.	113

GM Laboratories, Inc.	394
G-V Controls Inc.	190
Gamewell Co.	216
Garde Manufacturing Co.	378
Gates Electronic Co.	400
General Ceramics Corp.	49
General Dry Batteries Inc.	331
General Electric Co.	
Apparatus Dept.	112, 207, 365
Electronics Dept.	118
Electronic Components Dept.	23
General Radio Co.	17
Georgia Dept. of Commerce	99
Giannini & Co., Inc., G. M.	402
Good-all Electric Mfg. Co.	249
Grant Pulley & Hardware Corp.	374
Graphite Metallizing Corp.	404
Green Instrument Co.	371
Greenleaf Mfg. Co.	75
Gries Reproducer Corp.	392
Guardian Electric Mfg. Co.	257

Hammarlund Mfg. Co., Inc.	25
Hart Mfg. Co.	346
Hayden Assoc., Paul	408
Haydon Company, A. W.	210
Haydon Manufacturing Co., Inc.	302
Heath Company	394
Heiland, A Div. of Minneapolis-Honeywell	340
Helipot Corp., Div. of Beckman Instruments, Inc.	179
Hermetic Seal Products Co.	43

Hewlett-Packard Company	53
Hitemp Wires, Inc.	292
Hoffman Laboratories, Inc.	233
Houghton Laboratories Co.	254
Hudson Tool & Die Company, Inc.	247
Hughes Aircraft Co.	195
Hughes Research & Development Laboratories	191, 300
Hycor Company, Inc.	399

Indiana Steel Products Company	54
Industrial Test Equipment Co.	390
Institute of Radio Engineers	245
International Nickel Co., Inc.	237
International Rectifier Corp.	267
International Resistance Co.	100, 101
Ippolito & Co., Inc., James	377

Jennings Radio Mfg. Corp.	256
Johnson Company, E. F.	310
Jones Div., Howard B., Clinch Mfg. Co.	406
Joy Manufacturing Co.	225

Kahle Engineering Co.	15
Kaiser Metal Products Inc.	110
Kartron	408
Kay Electric Co.	27
Kearfott Co., Inc.	192, 304
Kennedy & Co., Inc.	354
Kepeo Laboratories	177
Kester Solder Co.	223
Kinney Mfg. Division, New York Air Brake Company	311
Koch Fiberglas	80
Kollsman Instrument Corp.	55
Kwikheat Manufacturing Co.	402

L M Electronics, Inc.	206
Laboratory for Electronics, Inc.	59
Lambda Electronics Corp.	106
Lampkin Laboratories, Inc.	371
Land Air Inc.	397
Lapp Insulator Co., Inc.	266
Leach Corp., Inet-Palmer Div.	259
Leeds & Northrup Company	201
Lewis Spring & Mfg. Co.	182
Librascope, Inc.	393
Link Aviation, Inc.	358
Litton Engineering Laboratories	395
Lockheed Missile Systems Div.	298
London Chemical Company, Inc.	386
Los Alamos Scientific Laboratory	384

M B Manufacturing Co., Inc.	97
MacDonald Inc., Samuel K.	408



NEW!

RADIO FREQUENCY POWER METER

PM-19

5 FULL METER SCALES FROM 1½ TO 120 WATTS

FREQUENCY RANGE
0.1 to 500 MEGACYCLES.

(Can Be Calibrated at 60 cps.)

Now you can measure from 100 milliwatts to 120 watts with Power Meter PM-19.

- Self-cooled.
- Accuracy $\pm 5\%$.
- Input Connector Type N.
- Input Impedance 52 ohms.
- Meter Ranges: 0 to 1½, 0 to 6, 0 to 15, 0 to 60, 0 to 120 watts.
- Input Power 115 Volts 60 cps or 6 Volts AC or DC.

ELECTRO IMPULSE Laboratory

208 River Street • Red Bank, New Jersey • Phone: Redbank 6-0404

MINIATURIZE with

SUPEREX

Ferrite-core **RF CHOKES!**

NEW*



FERRI-CHOKES



Smallest, most efficient chokes ever produced!

BEST BY SCIENTIFIC TEST—electrical comparison tests prove without doubt the superiority of the modern Superex Ferri-choke over conventional RF chokes.

- Lower D-C Resistance
 - Higher Q
 - Minimum Distributed Capacity
 - Lighter in Weight
 - Smallest Physical Dimension
- Model F-25 2.5 mh 125 ma
F-50 5.0 mh 125 ma
F-100 10.0 mh 125 ma
- * **Newest subminiature choke.**

VAR-CHOKES



HIGH INDUCTANCE RATIO—a series of variable inductances with a range as high as 10 to 1 within physical dimensions not considered possible until the introduction of the Ferrite Core.

Available in 7 stock sizes covering range of 40 microhenries to .5 henry. Other values to specification.

For Full Line Catalog write:
INDUSTRIAL DIVISION, DEPT. E-6

Superex ELECTRONICS CORP. successor to Grayburne
4 Radford Pl., Yonkers, N.Y.

the ONLY instrument in the field
that offers ALL these features at



the new
DS-6100-T
FREQUENCY-PERIOD
electronic counter

A compact frequency-period counter designed for direct measurement of any mechanical, electrical or optical phenomena which can be converted to a varying voltage. Read-out in direct digital form. Ideal for use by skilled or unskilled personnel. Price \$700.00.

Write for complete catalog data **TODAY!**



Q-116

**NO
EXTRA
COST!**

- **FREQUENCY Measurement**
- **1 and 10 SECOND Time Base**
- **PERIOD Measurement**
- **1 and 10 CYCLE Gate Time**
- **PRECISION ACCURACY Over 1-100,000 cps range**
- **EASILY PORTABLE Only 28 Pounds**
- **SMALL SIZE 14 1/4" W x 7 1/2" H x 13 1/2" D**

Visit us in
Booth 424
Automation Show
Chicago-Navy Pier

Representatives in all major areas.

COMPUTER-MEASUREMENT CORP.

5457 Cleon Avenue, Dept. 78-J
North Hollywood, California

Magnatran, Inc.	348
Magnetic Amplifiers, Inc.	370
Magnetics, Inc.	185
Mallory and Co., Inc., P. R.	120, 175
Marconi Instruments, Ltd.	56
Markem Machine Co.	380
Martin Company, Glenn L.	203, 332
McCoy Electronics Co.	188
McGraw-Hill Book Co.	396
Measurements Corporation	389
Metals & Controls Corp., General Plate Div.	321
Midwestern Instruments	36
Millen Mfg. Co., Inc., James.	226
Minneapolis-Honeywell Regulator Co., Industrial Div.	108
Minnesota Mining & Mfg. Co.	30, 31
Missouri Division of Resources & Development	362
Monsanto Chemical Co.	307
Moseley Co., F. L.	400
Muirhead & Co., Ltd.	5
Mullard Overseas Ltd.	283
Mycalex Corp. of America	333

N J E Corporation.	119
Narda Corporation	334
Naresco Equipment Corporation Sub. of National Research Corp.	325
National Moldite Co.	68
Natvar Corporation	67
New Hampshire Ball Bearings, Inc.	242
Newhope Corp.	408
Ney Company, J. M.	377
Nopco Chemical Co.	227
Norden-Ketay Corp.	88, 89
Northeastern Engineering, Inc.	93

Offner Electronics, Inc.	230
Ohmite Manufacturing Co.	32A, 32B
Oster Manufacturing Co., Inc.	48

Panoramic Radio Products, Inc.	330
Perkin Engineering Corp.	21
Permag Corporation	363
Phalo Plastics Corp.	286
Phelps Dodge Copper Products Corp., Inca Mfg. Div.	82, 83
Phillips Control Corp.	274
Phillips Process Co., Inc.	384
Photocircuits Corp.	296
Pix Manufacturing Co., Inc.	373
Plasteck, Inc.	376
Polarad Electronics Corporation.	34, 35, 191
Polymer Corp. of Penna.	248
Polytechnic Research & Development Co., Inc.	60
Precision Apparatus Co., Inc.	460
Precision Paper Tube Co.	258
Progressive Mfg. Co.	306
Pye Ltd.	305

U.S.C. MINIATURE CONNECTORS

Quality Controlled Contact Dependability

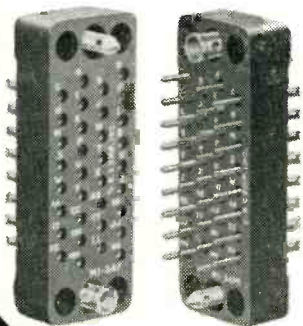

MI-34F

MI-34M

Individual processing of each contact assures quality control throughout with 100% dependability of contact.

Guide pins have the feature of a 1/16" D hole to provide easy assembly to chassis or hood with as simple a tool as a paper clip. This eliminates possible distortion of Guide pin.

MI SERIES

Plugs—MI-7M, 8-4M, 14M, 18M, 20M, 21M, 26M, 34M, 41M, 50M, 75M
Receptacles—MI-7F, 8-4F, 14F, 18F, 20F, 21F, 26F, 34F, 50F, 75F

USC's complete engineering, tooling and production facilities are geared to produce quality connectors, allied components and assemblies. Our over 25 years experience is at your service.

We invite inquiries on your sub-miniaturization problems

We now manufacture over 1001 connector items.

U. S. COMPONENTS, Inc.
Associated with U. S. Tool and Mfg. Co., Inc.
454-462 East 148th Street, New York 55, N. Y. CYPress 2-6525-6

R-F Electronics, Inc., Div. of Electro Switch Corp. 236
 Radiation, Inc. 379
 Radio Condenser Co. 313
 Radio Corporation of America, 4th Cover 390
 Radio Engineering Products 390
 Radio Frequency Laboratories, Inc. 329
 Radio Industries, Inc. 76
 Radio Materials Corp. 193
 Radio Receptor Co., Inc. 116
 Railway Express Agency, Air Express Div. 235
 Ramo Wooldridge Corp. 217
 Raybestos-Manhattan, Inc. 66
 Raytheon Mfg. Company 18, 19, 111, 327
 Reeves Instrument Corp. 65
 Resin Industries, Inc. 228
 Resinite Corp., Div. of Precision Paper Tube Co. 360
 Resistance Products Co. 345
 Revere Copper & Brass Inc. 85
 Revere Corporation of America 288
 Rome Cable Corp. 79
 Rotron Manufacturing Co., Inc. 367
 Rowe Engravers 408

Saft Corporation of America 269
 Sargent-Rayment Co. 375
 Sauereisen Cements Co. 408
 Scientific Radio Products, Inc. 250
 Seovill Manufacturing Company 341
 Shallcross Manufacturing Co. 355
 Sierra Electronic Corporation 342
 Sigma Instruments, Inc. 280
 Signal Engineering & Mfg. Co. 382
 Skydyne Inc. 403
 Sola Electric Co. 44
 Solar Mfg. Corp. 335
 Solartron Electronic Group Ltd. 115
 Sorensen & Co., Inc. 4
 Southeo Div., South Chester Corp. 356
 Southern Electronics Corp. 328
 Southwestern Industrial Electronics Co. 351
 Spencer-Kennedy Laboratories, Inc. 382
 Sprague Electric Co. 11, 181, 378
 Stackpole Carbon Co. 63
 Standard Cabinet Company 362
 Standard Electric Time Company 52
 Star Porcelain Co. 406
 Sterling Transformer Corp. 388
 Stevens Arnold Inc. 405
 Stoddart Aircraft Radio Co., Inc. 238, 324
 Stupakoff Ceramic & Mfg. Co., Div. of the Carborundum Company 338, 339
 Sturtevant Co., P. A. 404
 Sun Tube Corp. 262
 Superex Electronics Corp. 457
 Superior Electric Company 309
 Superior Tube Co. 50
 Sylvania Electric Products, Inc. 9, 271, 277



precision

Fluorocarbon Parts

▶ meet exacting specifications . . .
 ▶ cut assembly costs

Profit from precision parts, fabricated from duPont TEFLON, Kellogg KAL-F, BAKELITE fluorothene resins and other plastics — by United States Gasket Company.

Quality controlled "from powder to part," they assure uniform electrical, chemical and physical characteristics of the highest quality. Uniform density and dimensional stability permit superior accuracy and dependability in the finished part.

Come to USG for all your requirements — Fluorocarbon sheets, tape, tubing, cylinders, rods, bars, leading, electrical spaghetti — as well as molded and machined parts to your own specifications.

Write for catalog No. 300.

UNITED STATES GASKET COMPANY
 CAMDEN 1, NEW JERSEY



USG

FABRICATORS OF
FLUOROCARBONS & OTHER PLASTICS



Representatives in principal cities throughout the world



THE NEW **PRECISION** MODEL **120**

GIVES YOU WHAT YOU WANTED
IN A
**HIGH SENSITIVITY
MULTI-RANGE TEST SET**

20,000 OHMS PER VOLT D.C.
5,000 OHMS PER VOLT A.C.

The '120' gives you . . .

- ✓ MORE RANGES
- ✓ AN EXTRA-LOW RESISTANCE RANGE
- ✓ AN EXTRA-LOW VOLTAGE RANGE
- ✓ AN EXTENDED LOW CURRENT RANGE
- ✓ A LARGER METER SCALE FACE
- ✓ SIMPLE, POSITIVE RANGE SELECTION
- ✓ POSITIVE CONTACT JACKS and PLUGS

Compare These Wide Spread Ranges and Special Features:

- ★ 8 DC VOLTAGE RANGES: 20,000 ohms per volt.
- ★ 8 AC VOLTAGE RANGES: 5,000 ohms per volt.
0-1-2-3-12-60-300-600-1200-6000 volts.
- ★ 8 AC OUTPUT RANGES: same as AC volt ranges.
Built-in 600 volt blocking capacitor.
- ★ 7 DC CURRENT RANGES:
0-60-300 Microamperes. 0-1-2-12-120-600 Ma.
0-12 Amperes.
- ★ 5 RESISTANCE RANGES: self-contained.
0-200-2000-200,000 ohms. 0-2-20 megohms.
- ★ 8 DECIBEL RANGES: -20 DB to +77DB.
0 DB = 1 Milliwatt, 600 ohms.
- ★ EXTRA LARGE 5¼" RUGGED 'PACE' METER:
40 microamperes sensitivity, 2% accuracy.
- ★ 1% MULTIPLIERS and SHUNTS:
Wire-wound and deposited film types.
- ★ TWO JACKS SERVE ALL STANDARD RANGES:
Separately identified and isolated jacks
provide for extra high ranges.
- ★ "TRANSIT" SAFETY POSITION on range selector
protects meter during transport and storage.
- ★ CUSTOM-MOLDED PHENOLIC CASE and PANEL:
Compact, laboratory styled instrument.

MODEL 120...complete with internal ohmmeter
batteries, banana-plug test leads and detailed
operating manual. Overall case dimensions,
5½ x 7 x 3½" Net Price \$39.95

PRECISION Apparatus Company, Inc.

70-31 84th Street, Glendale 27, L. I., N. Y.
Export: 458 Broadway, New York 13, U. S. A.
Canada: Atlas Radio Corp., Ltd., 50 Wingold Ave., Toronto 10

Want more information? Use post card on last page.

460

Taylor Fibre Co.	205	Western Gear Corporation	187
Technicraft Laboratories, Inc.	320	Westinghouse Electric Corp.	265, 312
Technical Materiel Corp.	397	Weston Electrical Instrument Corp.	38
Technical Writing Service.	408	White Dental Mfg. Co., S. S.	368
Technology Instrument Corp.	361	Whitney Blake Company.	352
Teiner Engineering Corp.	385	Wickes Engineering and Construction Co.	375
Tektronix, Inc.	293	Williams & Co., C. K.	376
Tele Coil Co., Inc.	363	Wincharger Corp.	84
Tel-Instrument Electronics Corp.	375	Woods Aircraft Supply.	368
Texas Instruments, Inc.	231		
Textile Banking Co., Inc.	301		
Thermal American Fused Quartz Co., Inc.	379		
Thomas Instrument Company.	395		
Transcoil Corporation.	315		
Transradio, Ltd.	372	Zenith Radio Corporation.	319
Transitron Electronic Corp.	211	Zopher Mills, Inc.	404
Trans-Sonics, Inc.	322		
Tung-Sol Electric, Inc.	96A, 96B		

MANUFACTURER'S REPRESENTATIVES

U. S. Components.	458
U. S. Engineering Co., Inc.	260
Ucinite Co.	46
Union Carbide & Carbon Corp., Bakelite Company.	73
Union Switch & Signal Div. of Westing- house Air Brake Company.	326
United Electronics.	87
United States Gasket Co.	459
United Technical Laboratories.	383
United Transformer Co.	2nd Cover
Universal Winding Co.	215
University of California Press.	383

PROFESSIONAL SERVICES

Vacuum Metals Corp.	114
Varflex Sales Co., Inc.	37
Vectron, Inc.	198
Veeder-Root, Inc.	40
Vietoreen Instrument Corp.	359
Volkert Stampings, Inc.	77

CLASSIFIED ADVERTISING

F. J. Eberle, Asst Mgr.

SEARCHLIGHT ADVERTISING.	438-454
ADVERTISERS INDEX.	450
EMPLOYMENT OPPORTUNITIES.	409-437
ADVERTISERS INDEX.	438

Waldes Kohinoor, Inc.	199
Waterman Products Co., Inc.	214
Waters Manufacturing, Inc.	405
Webster Chicago.	78
Weckesser Co.	402
Welch Scientific Co., W. M.	403
Welwyn International Inc.	379
Wenco Manufacturing Co.	399

This index is published as a convenience to the
readers. Every care is taken to make it accurate, but
ELECTRONICS assumes no responsibility for errors or
omissions.

Size has nothing to do with accomplishment



Inside these fully encapsulated miniature precision wire wound resistors, Daven furnishes the solution to problems presented by space limitations. A new winding technique permits the use of extremely fine sizes of resistance wire to obtain two or three times the resistance value previously supplied on a miniature bobbin. This new development more firmly establishes DAVEN'S leadership in the field of miniature and standard size precision wire wound resistors.

Types and Specifications

Type	Dia.	Length	Max. Res.	Wattage Rating	Terminals
1273	1/4	5/16	400K	.1	One End #22 Gauge
1283	1/4	5/16	400K	.1	Axial #22 Gauge
1274	3/16	3/8	100K	.1	Axial #22 Gauge
1284	1/4	27/64	.5 Meg.	.25	One end #20 Gauge
1192	1/4	1	1.0 Meg.	.75	Axial #22 Gauge

- Fully encapsulated.
- Meet and exceed all humidity, salt water immersion and cycling tests as specified in MIL-R-93A, Amendment 3.
- Operate at 125°C continuous power without de-rating.

- Can be obtained in tolerances as close as $\pm 0.05\%$.
 - Standard temperature coefficient is $\pm 20\text{PPM}/^\circ\text{C}$.
- Special coefficients can be supplied on request.

For maximum resistance in minimum space:

Daven's new winding technique cuts giants down to size



THE **DAVEN** CO.



528 West Mt. Pleasant Ave.
Route 10, Livingston, N. J.

Write for complete resistor catalog.

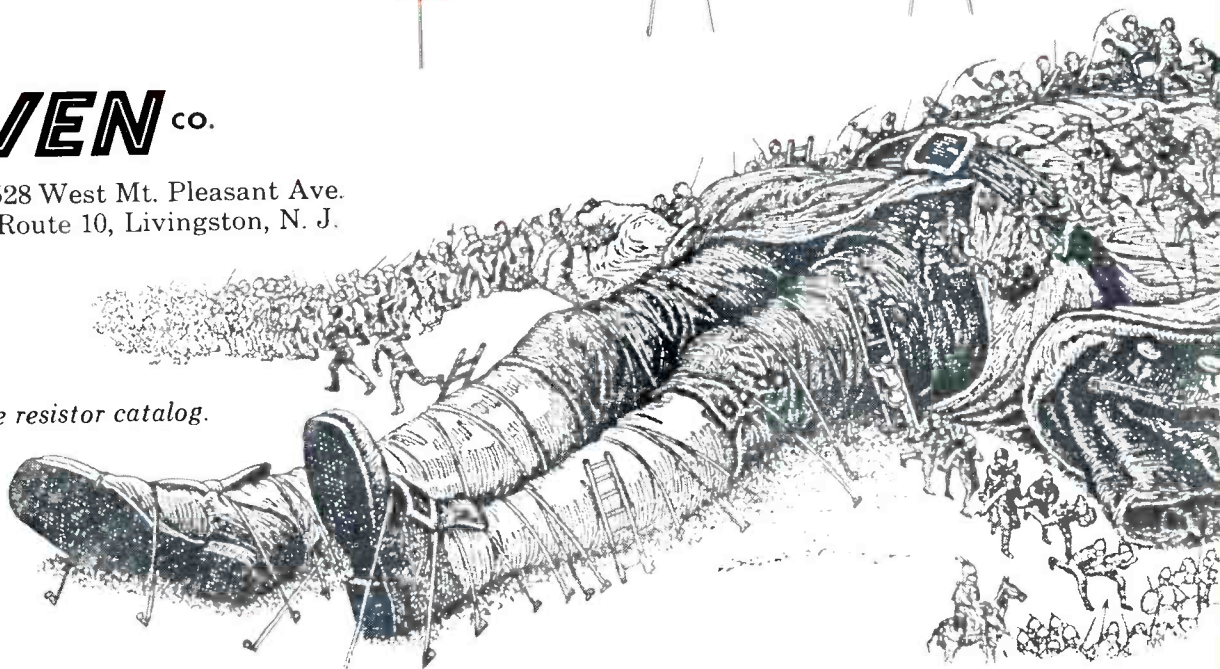

WORLD'S LARGEST MANUFACTURER OF ATTENUATORS

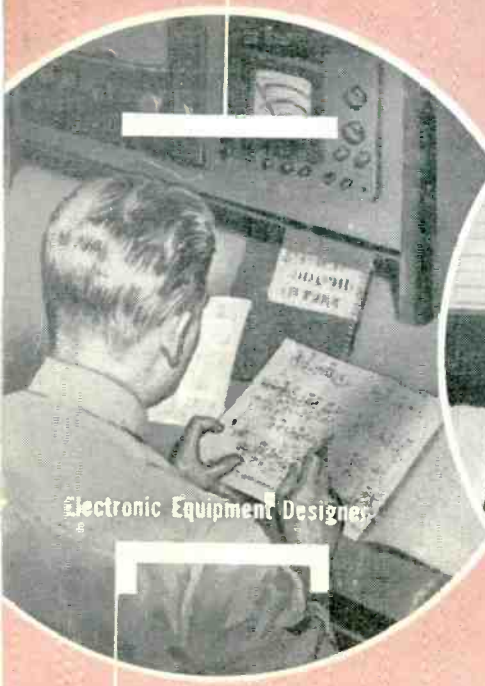

Electronic Equipment Designer



RCA Field Engineer

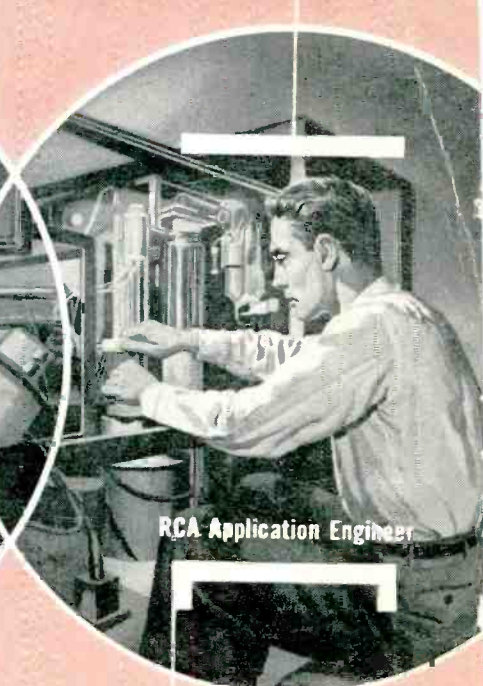

RCA Application Engineer

COMMON GROUND-WORK

... originates better tubes and components

... develops superior equipment

Tubes . . . Electronic Components . . . Design Service—common ground for RCA Field Engineers, RCA Application Engineers, and You, the designers of electronic equipment.

Your RCA Field Engineer is a specialist who devotes his time *exclusively* to the proper application of RCA products in practical electronic equipment design and production. Having a thorough knowledge of the "overall picture," he is equipped to help you select the right tubes and components for your "difficult" applications. Your RCA Field Engineer is your link with RCA Development and Application Engineers . . . a team of specialists constantly working toward better tubes, better components, better circuits, *for you*.

For experienced assistance in practical applications of tubes and electronic components, call or write your RCA Field Engineer at the office nearest you:

EAST: HUmboldt 5-3900, 744 Broad Street, Newark 1, N. J.

MIDWEST: WHitehall 4-2900, Suite 1181, Merchandise Mart Plaza, Chicago 54, Ill.

WEST: RAymond 3 8361, 6355 E. Washington Blvd., Los Angeles 22, Calif.

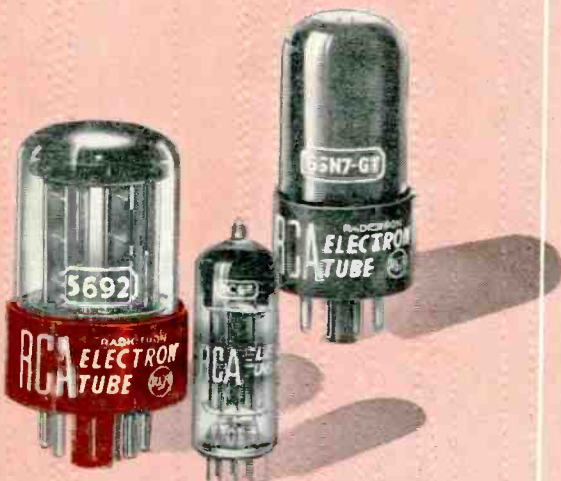

Time-Proved RCA Tube Designs—
through common ground-work

For example: RCA-developed 6SN7-GT has been meeting the needs of circuit designers for fifteen years—served as prototype for industrial "Special Red" RCA-5692, and the "modern miniature" RCA-6CG7.



RADIO CORPORATION of AMERICA
ELECTRON TUBES

HARRISON, N. J.